



COUNTY OF EL DORADO, CALIFORNIA

BOARD OF SUPERVISORS POLICY

Subject: INJURY AND ILLNESS PREVENTION PROGRAM	Policy Number: K-1	Page Number: Page 1 of 15
	Date Adopted: 08/15/1986	Revised Date: 07/23/2019

PURPOSE

The California Labor Code, Chapter 1369, Section 6401.7 and the California Code of Regulations, Title 8, Sections 1509 and 3203 require the County of El Dorado (County) to develop and implement an employee Illness and Injury Prevention Program (IIPP). This policy establishes that program which applies to all County employees and volunteers. The purpose of this policy is to define responsibilities related to the establishment, implementation, and maintenance of the County’s programs related to occupational safety and health.

POLICY

It is the policy of the County Board of Supervisors to provide a safe and healthful workplace by establishing guidelines and procedures for the development and maintenance of an ongoing IIPP in compliance with the California Labor Code and the California Code of Regulations. A copy of the County’s or department-specific IIPP shall be in writing within each department and shall integrate the policies and procedures intended to identify, control, and resolve occupational hazards and incidents. A safe and healthful workplace is accomplished through communication, training, ongoing inspections, and collaborative investigations. Response to safety concerns will be given the highest priority at every level of the County.

PROCEDURE

County Safety Committee

The County Safety Committee is responsible for the development of programs and initiatives to promote occupational health and safety in an effort to prevent and to reduce accidental losses within the offices, institutions, and departments of the County. Membership consists of the following:

- Chair: Chief Administrative Officer (CAO) or designee
- Member/Secretary Risk Manager or designee
- Member: Director of Human Resources or designee
- Member: Sheriff/Coroner/Public Administrator or designee
- Member: Director, Health and Human Services Agency (HHSA) or designee
- Member: Information Technologies Director or designee
- Member: County Counsel Director or designee
- Member: Community Development Services designee
- Member: Such representatives as appointed or invited by members



COUNTY OF EL DORADO, CALIFORNIA BOARD OF SUPERVISORS POLICY

Subject: INJURY AND ILLNESS PREVENTION PROGRAM	Policy Number: K-1	Page Number: Page 2 of 15
	Date Adopted: 08/15/1986	Revised Date: 07/23/2019

County Safety Committee meetings will be held bi-annually and shall include a review of accident events, health/safety exposures, and actions taken to prevent future occurrences. They will also address the elimination of risks found during safety inspections. The meeting shall include County-wide safety topics, trends, recent/potential safety issues, and will maintain an element of Enterprise Risk Management (ERM) including:

- A. Resolve to proactively manage risks rather than to react to them;
- B. Clarify the organization's risk philosophy and develop a strategy to achieve it;
- C. Think broadly and examine carefully events that may affect the organization's objectives;
- D. Collaboratively develop action plans and share strategies and outcomes with other departments;
- E. Assess risks and maintain the flexibility to respond to new or unanticipated risks;
- F. Use metrics to monitor the effectiveness of the risk management process where possible;
- G. Circulate risk information throughout the organization; and
- H. Embed ERM into the culture by integrating the knowledge of risks in internal audit planning, balanced scorecards, budgets and performance management systems.

Responsibility

The CAO is ultimately responsible for ensuring that a safe and healthy workplace is established and maintained. The CAO or designee will ensure that department heads implement the IIPP and develop corresponding safety policies and procedures for operations under their control. All County employees are responsible for promoting safety and enhancing the effectiveness of safety awareness, training, accident prevention, and emergency preparedness.

Department heads or their designees shall:

- A. Develop department-specific IIPP safety policies and procedures when department operations fall outside of the scope of the County IIPP, including department-specific Code of Safe Work Practices (COSWP) and facility-specific Emergency Action Plans (EAP);
- B. Ensure a hard copy of the IIPP, including the EAP and COSWP, are in writing, readily available, and its location known by all department personnel;
- C. Be familiar with and ensure department personnel are familiar with the attached County policies in support of the IIPP;
- D. Appoint one or more department safety coordinators (DSC);



COUNTY OF EL DORADO, CALIFORNIA

BOARD OF SUPERVISORS POLICY

Subject: INJURY AND ILLNESS PREVENTION PROGRAM	Policy Number: K-1	Page Number: Page 3 of 15
	Date Adopted: 08/15/1986	Revised Date: 07/23/2019

- E. Provide employee IIPP orientation and department and job-specific safety training prior to assignment of employees;
- F. Post all health and safety information, such as safety posters and the Occupational Safety and Health Administration (OSHA) 300 Log annual summary;
- G. Participate on the County Safety Committee;
- H. Designate staff responsible for serving on the department safety committee and ensure quarterly meetings are held;
- I. Ensure that each supervisor adheres to adopted policies and procedures and consistently enforces safety rules and regulations; and
- J. Upon request from the Human Resources Department, Risk Management Division, verifying abatement action taken to mitigate citations issued by the California Division of Occupational Safety and Health (Cal/OSHA);

Managers and supervisors are integral components in ensuring an injury and illness free workplace and complying with applicable laws and regulations governing workplace safety. Employees in these positions are responsible for the safety of their subordinates and for ensuring that employees know and abide by the IIPP and corresponding safety policies and procedures. Managers and supervisors shall:

- A. Be aware of safety and health regulations affecting operations;
- B. Schedule, conduct, and record new-employee safety orientation and ongoing safety training;
- C. Enforce safety policies and procedures;
- D. Investigate accidents, injuries, and near misses and prepare written documentation;
- E. Evaluate new equipment and procedures and make recommendations to the department head, safety coordinator, and/or Risk Management;
- F. Ensure the maintenance of materials and equipment in safe operating conditions per the manufacturer's specifications;
- G. Determine necessary personal protective equipment and provide training for the proper selection, usage, maintenance, and disposal;
- H. Inspect work areas routinely;
- I. Train employees in the identification and reporting of safety hazards and concerns;
- J. Work with the department head, department safety coordinator, and Risk Management on all safety related issues;



COUNTY OF EL DORADO, CALIFORNIA

BOARD OF SUPERVISORS POLICY

Subject: INJURY AND ILLNESS PREVENTION PROGRAM	Policy Number: K-1	Page Number: Page 4 of 15
	Date Adopted: 08/15/1986	Revised Date: 07/23/2019

- K. Correct or report unsafe conditions; and
- L. Implement and document the training program designed to instruct employees in safe work practices and specific job duties.

DSC's are responsible for:

- A. Conducting, facilitating, or assisting ongoing department safety committee meetings with management and employee representatives and maintaining written records of attendance and topics discussed;
- B. Conducting periodic facility safety inspections and recommending appropriate measures for the elimination of unsafe conditions;
- C. Ensuring employees are informed of any identified hazards;
- D. Maintaining a department safety bulletin board;
- E. Representing employees on health and safety issues;
- F. Acting as a liaison to Risk Management;
- G. Participating in incident investigations;
- H. Periodically updating the department head on safety activities with a copy to the County Safety Officer; and
- I. Reviewing investigations of occupational accidents, injury, illness or exposure to hazards, and identifying preventative measures.

Employees are responsible for:

- A. Becoming familiar with and complying with the County and Department IIPP's in addition to corresponding safety policies and procedures;
- B. Reporting any hazardous conditions and equipment to supervisors;
- C. Observing all County safety policies, procedures, and rules;
- D. Using all safety clothing, equipment, and personal protective equipment (PPE) as required;
- E. Not performing any job duties for which safety training has not been provided;
- F. Attending all general and tailgate safety meetings; and
- G. Reporting all injuries, accidents, and near-miss incidents to supervisors.

Risk Management shall:

- A. Be responsible for establishing, implementing, and maintaining an effective



COUNTY OF EL DORADO, CALIFORNIA

BOARD OF SUPERVISORS POLICY

Subject: INJURY AND ILLNESS PREVENTION PROGRAM	Policy Number: K-1	Page Number: Page 5 of 15
	Date Adopted: 08/15/1986	Revised Date: 07/23/2019

County-wide IIPP;

- B. Be the County liaison with Cal/OSHA;
- C. Advise departments on safety and health policy issues and assist in developing and implementing department-specific IIPPs and policies;
- D. Keep abreast of current information on federal, state, and local safety and health laws, regulations, and ordinances;
- E. Coordinate development and implementation of the County-wide IIPP with all departments;
- F. Maintain records of employee accidents and injuries, and review injury and illness trends;
- G. Track hazard reports and safety concerns through resolution;
- H. Investigate and report to Cal/OSHA any serious injuries resulting in hospitalization or fatality, and provide recommendations to prevent reoccurrence;
- I. Provide technical assistance and recommendations on occupational health and safety issues to departments;
- J. Facilitate and participate in the County Safety Committee meetings;
- K. Facilitate environmental monitoring of work sites where employees have potential exposure to harmful biological, chemical, or physical agents; and
- L. Investigate reports of hazardous conditions, accidents, injuries, and near-misses, and make necessary remedial recommendations.

Compliance

The expectation is for all agents of the County, including employees and volunteers, to abide by the policies and procedures contained within the IIPP and corresponding regulatory compliance policies. The willful violation of County-wide or Department safety rules or state regulations may result in disciplinary action up to and including termination. All disciplinary action will be in compliance with the current and applicable Personnel Rules, Memoranda of Understanding, or Salary and Benefits Resolution for employees.

Communication

Every County employee is encouraged to suggest or recommend measures which will eliminate unsafe practices or unsafe physical conditions. Employees are required to report any hazardous conditions to



COUNTY OF EL DORADO, CALIFORNIA

BOARD OF SUPERVISORS POLICY

Subject: INJURY AND ILLNESS PREVENTION PROGRAM	Policy Number: K-1	Page Number: Page 6 of 15
	Date Adopted: 08/15/1986	Revised Date: 07/23/2019

their immediate supervisor. Employees may report safety concerns anonymously or directly to Risk Management. No employee shall be disciplined for reporting any workplace hazard or unsafe condition or practice. The following methods have been established to communicate with employees on matters relating to health and safety:

- A. Departments that utilize safety committees will schedule meetings at least quarterly. Records will be maintained for a period of at least two years and will contain the dates of meeting, agendas, attendance rosters, and summary minutes of the issues discussed. Administrative departments may establish employee communication programs other than a safety committee.
- B. Individual departments are responsible for maintaining current hazardous chemical or substance Safety Data Sheets (SDS) for their departments. SDS's regarding hazardous materials that employees may be exposed to while working shall be maintained in the department's Hazard Communication binder (physical or online) and shall include an SDS for every hazardous chemical or substance used or encountered as part of the job and be readily available for employees to review.
- C. Managers and supervisors will encourage employees to report any unsafe or unhealthy conditions that they discover without fear of reprisal. In some cases, suggestion boxes may be available to provide employee anonymity and encourage prompt reporting of safety concerns. Employees may also communicate suggestions in face-to-face conversations, via telephone, through interoffice mail, by completing the online "See Something Say Something" form on the Risk Management intranet website or via email to their managers, DSC, or Risk Management.
- D. Employees will be informed of safety rules and Cal/OSHA regulations through the County safety training program.
- E. County-wide safety policies and programs will be available on the Risk Management intranet web site. Hard copies of the IIPP will be available in all departments. Department-specific safety policies and procedures will be available from the department.
- F. Communication regarding workplace hazards is accomplished through documents including:
 1. Safety Orientation Checklist (Attachment 2)
 2. Incident Report Form (Attachment 3)
 3. Driver's Report of Accident (Attachment 4)
 4. County Safety Inspection Checklist (Attachment 5)
 5. Monthly Risk Management newsletter



COUNTY OF EL DORADO, CALIFORNIA

BOARD OF SUPERVISORS POLICY

Subject: INJURY AND ILLNESS PREVENTION PROGRAM	Policy Number: K-1	Page Number: Page 7 of 15
	Date Adopted: 08/15/1986	Revised Date: 07/23/2019

G. Department safety bulletin boards shall, at a minimum, include:

1. Evacuation plan for the area;
2. Identification of all fire extinguishers;
3. Name and extension for the DSC;
4. Name and extensions of Risk Management personnel;
5. Emergency and safety phone numbers including, but not limited to: Fire, Law Enforcement, Poison Control, and Cal/OSHA; and
6. Upcoming safety training classes and schedules.

Department heads may develop specific safety rules. Such rules are subject to review by Risk Management. Upon approval, department-specific safety rules will be published for distribution to all affected employees and comply with County-wide safety plans required for regulatory compliance (Attached Policies 1-18).

Hazard Assessment

Departments will investigate all hazard reports and, when needed, in partnership with Risk Management. Identified hazardous conditions will be prioritized for correction through consideration of both the potential consequence (severity) and probability (frequency) of an injury or illness occurring. Risk Management staff will provide or obtain expert assistance when necessary. Workplace hazards are assessed the following ways:

- A. Risk Management staff will assist department staff in conducting periodic scheduled and unscheduled inspections of all County facilities. Supervisors are responsible for the safety of physical conditions in which their subordinates work. Each supervisor will make frequent work area inspections. Departments engaged in hazardous operations are strongly encouraged to schedule frequent inspections such as monthly, weekly, or daily depending on the operation. Safety inspection forms are available from the Risk Management office as well as on its website, and are included in Attachment 5. Inspection recommendations will be made to the department head and also reported to the DSC and Risk Management.
 1. Informal Inspections: Informal inspections can be done at any time. Department heads, DSCs, managers, and supervisors are responsible for ensuring safety inspections take place in their work areas daily; these inspections are unscheduled and informal.
 2. Scheduled Inspections: Each department shall conduct scheduled inspections. If the department has a workplace with hazards that are not addressed in the County Safety Inspection Checklist, a specific inspection checklist shall be created by that department



COUNTY OF EL DORADO, CALIFORNIA

BOARD OF SUPERVISORS POLICY

Subject: INJURY AND ILLNESS PREVENTION PROGRAM	Policy Number: K-1	Page Number: Page 8 of 15
	Date Adopted: 08/15/1986	Revised Date: 07/23/2019

to address the work area needs. Departments shall forward a copy of completed inspection checklists to Risk Management and retain originals for a minimum of one year. It is recommended that all County facilities be inspected at least annually. Department heads shall identify a set schedule for inspections of their facilities.

3. Additional Inspections: Each department shall conduct inspections in addition to those described above whenever (i) new substances, processes, procedures, or equipment are introduced to the workplace that represent a new occupational safety and health hazard, or (ii) the department is made aware of a new or previously unrecognized hazard.
 - B. All employees are encouraged to identify, correct (if possible and safe to do so), and report hazards and poor safety practices. If there is a danger of imminent harm to employees and/or property, the employee shall immediately stop the process and vacate the area, report the hazard immediately to their supervisor, manager, department head, DSC, and/or Risk Management. Any condition or practice that may cause death or serious physical harm is considered an imminent hazard. Submission of the Incident Report form shall not be delayed until after the hazard has been abated. The department head will assure that all employees are informed of imminent hazards and that all necessary precautions are taken to prevent injuries or illnesses.
 - C. Safety suggestions will be assessed at the department level through regular lines of authority (e.g., chain of command). Those suggestions that cannot be approved or disapproved at the department level will be referred to Risk Management.

Accident/Hazard Exposure Investigation

The purpose of the investigation is to gather facts to determine the cause of the injury, illness, or accident; the purpose is not to assign blame. Serious risks shall be investigated immediately. All accidents, incidents, and near-miss investigations shall be initiated as soon as personnel are aware, and corrective actions to prevent reoccurrence documented. The investigation shall be performed by the involved department unless otherwise mandated by statute. In the event that an investigation involves more than one department, a joint and cooperative investigation shall be done, or a request may be made to Risk Management for assistance in the investigation. If an investigation requires outside agencies, Risk Management shall provide any necessary assistance with cooperation of complimentary authorities.

Department procedures shall be established for the timely inspection of and response to any reported hazard. Procedures shall:

- A. Identify the party responsible for inspecting the reported incident and/or hazard;



COUNTY OF EL DORADO, CALIFORNIA BOARD OF SUPERVISORS POLICY

Subject: INJURY AND ILLNESS PREVENTION PROGRAM	Policy Number: K-1	Page Number: Page 9 of 15
	Date Adopted: 08/15/1986	Revised Date: 07/23/2019

- B. Specify the degree of participation of the department head, department staff, and Risk Management in the inspection process;
- C. Identify the party responsible for documenting the reported incident and/or hazard response;
- D. Describe the immediate and long term action(s) taken to abate the identified incident and/or hazard and the steps initiated to prevent hazard reoccurrence, including projected and actual dates for completion; and
- E. Ensure the Incident Report and the reported incident and/or hazard response are distributed to the department head, DSC, and Risk Management.

Basic rules for the investigation of reported work-related injuries, illnesses, or accidents, including incidents and near-misses:

- A. Unbiased approach for obtaining objective findings;
- B. Examination of the scene of the accident as soon as possible while the facts and evidence are fresh and before witnesses forget important details;
- C. Interview the injured worker at the scene (if any) and have them walk through a mock re-enactment of the accident. Interviews should be conducted privately;
- D. One-on-one interviews with witnesses. Talk with everyone who has knowledge of the accident;
- E. Signed statements in cases where facts are unclear or there is an element of controversy;
- F. Photographs, sketches, and diagrams including measurements when appropriate;
- G. Concentrate on causes and hazards;
- H. Analysis of what happened, how it happened, and how it could have been prevented. Determine what caused the accident itself, not just the injury;
- I. Preserve evidence;
- J. Open-ended questions that do not elicit one-word answers, such as, "What did you see?" rather than "Did you see anything?"; and
- K. Not accepting, denying, or promising anything.

Questions that should be answered during investigations of reported work-related injuries, illnesses, or accidents (including incidents and near-misses) may include:

- A. What was the person involved doing at the time of the accident?
- B. What tools or equipment were involved, if any?



COUNTY OF EL DORADO, CALIFORNIA BOARD OF SUPERVISORS POLICY

Subject: INJURY AND ILLNESS PREVENTION PROGRAM	Policy Number: K-1	Page Number: Page 10 of 15
	Date Adopted: 08/15/1986	Revised Date: 07/23/2019

- C. Where did the accident occur (be specific, including location, area, or job site)?
- D. What else was happening around the work area?
- E. Did the person involved know what the hazard was?
- F. Was the person involved trained on how to do the job?
- G. What contributed to the accident, such as another work group, defective tool, faulty equipment?
- H. Was more than one person involved? If so, who and how?
- I. Were there any witnesses? If so, who are they and what did they see?
- J. Was the accident preventable? If so, how?

Work Incurred Illnesses and Injuries

Work-specific injuries and illnesses shall be immediately called in to Company Nurse Injury Hotline at 1-877-545-9152 by the employee or their supervisor. Company Nurse will gather information over the phone and assist the injured worker in accessing appropriate medical evaluation. An employee who reports being injured on the job or has a work-related illness shall be provided with a Workers' Compensation claim form within 24 hours of reporting the employee's injury or illness. The completed and signed claim form shall be forwarded to Risk Management within 24 hours of receipt by the department. Risk Management shall notify Cal/OSHA of any serious injury, illness, or death of an employee occurring in a place of employment or in connection with any employment. This notification shall be as soon as practically possible, but no longer than eight hours after the County knows or with diligent inquiry would have known of the death or serious injury or illness.

Supervisors are responsible for:

- A. Securing further medical treatment for employees, if required, from a County physician or a pre-designated provider;
- B. Completing Form WC001, Report of Industrial Injury, for any employee who reports a work-incurred illness or injury and forwarding it to the Human Resources Department, Workers' Compensation Unit within 24 hours;
- C. Providing a DWC Form 1, Workers' Compensation Claim Form, to the worker within 24 hours of an illness or injury that requires medical treatment;
- D. Forwarding the completed DWC Form 1 to the Human Resources Department, Workers' Compensation Unit within 24 hours of receipt from the injured worker;
- E. Reporting any serious illness or injury involving hospitalization, loss of consciousness,



COUNTY OF EL DORADO, CALIFORNIA

BOARD OF SUPERVISORS POLICY

Subject: INJURY AND ILLNESS PREVENTION PROGRAM	Policy Number: K-1	Page Number: Page 11 of 15
	Date Adopted: 08/15/1986	Revised Date: 07/23/2019

dismemberment, disfigurement, or death to the Human Resources Department, Workers' Compensation Unit and Risk Management Division immediately by phone; and

- F. Investigating the cause of work-related illnesses and injuries, as well as near-misses.

Risk Management staff are responsible for:

- A. Providing workers' compensation benefits as set forth by the California workers' compensation laws, as well as the County of El Dorado Charter and Civil Service Board Rules;
- B. Collecting and collating OSHA 300 Illness and Injury Log data;
- C. Reporting any work related injury or illness which requires inpatient hospitalization for a period in excess of 24 hours for other than medical observation or in which an employee suffers a loss of any member of the body or suffers any serious degree of permanent disfigurement, but does not include any injury or illness or death caused by the commission of a Penal Code violation, except the violation of Section 385 of the Penal Code, or an accident on a public street or highway by immediately (within 8 hours) calling (916) 263-2800; and
- D. Distributing and posting printed copies of the annual OSHA 300 Illness and Injury Log as required by law from February through April of each year.

Motor Vehicle Accidents

It is the duty of the employee operating a vehicle on County business to immediately notify law enforcement if involved in an accident, no matter how minor. When a County driver or equipment is involved in an accident in another jurisdiction, the driver will call the California Highway Patrol or the local law enforcement agency to make an accident report. When it becomes necessary for a disabled county vehicle to be towed away as a result of an accident, the employee can contact Fleet Management to remove the vehicle. When this is not possible, law enforcement personnel investigating the accident will make the arrangements for the removal of the vehicle. Employees are responsible for completing a Driver's Report of Accident Form (Attachment 4) for all vehicle accidents. After the employee and supervisor have signed the accident report form, copies will be distributed as designated. Please refer to the County's Transportation Policy (D-4) for additional post-accident procedures.

Incidents Involving Non-Employees on County Premises

Any county employee who witnesses an incident involving a member of the public or any non-employee's interaction with County employees or property will complete an Incident Report and distribute it as designated on the form after emergency medical response is provided to the person(s) involved. The form will also be completed if a member of the public reports a loss or an



COUNTY OF EL DORADO, CALIFORNIA

BOARD OF SUPERVISORS POLICY

Subject: INJURY AND ILLNESS PREVENTION PROGRAM	Policy Number: K-1	Page Number: Page 12 of 15
	Date Adopted: 08/15/1986	Revised Date: 07/23/2019

injury involving the County.

Near-Misses

Near-misses are defined as unintended events which have the potential for causing personal injury, illness, property damage, or environmental impairment but do not actually result in personal injury, illness, property damage, or environmental impairment. Unsafe working conditions, unsafe employee work habits, improper use of equipment, or use of malfunctioning equipment have the potential to cause work-related injuries. It is every employee's responsibility to report or correct these near-miss incidents immediately. The Incident Report will be used to report and investigate near-misses.

Accident Investigation

Employees will not answer questions or discuss an accident with anyone except persons representing the County of El Dorado and law enforcement officers investigating the accident, except as advised by County Counsel. The purpose of the supervisor's investigation is to gather information and determine the cause(s) of accidents to prevent recurrence or to look into reported near-misses so they do not become incidents. The department head may require an additional investigation of accidents. In general, causes of accidents fall into four general categories: unsafe physical acts by people, unsafe physical conditions, unsafe equipment or use of equipment, and acts of nature. Risk Management may conduct an investigation of any accident or near-miss involving County employees or property when additional information is deemed necessary to determine cause. Accident investigation reports are confidential.

Hazard Correction

The County shall correct work conditions, practices, or procedures in a timely manner based on the severity of the hazards. Corrective action for hazard elimination is the responsibility of the department heads. Corrective action/abatement of reported workplace hazards:

- A. If the reported hazard is considered to be of an imminent nature by the department head, manager, supervisor, DSC, or Risk Management, immediate action shall be taken to eliminate or abate the hazard.
- B. If the reported hazard cannot be immediately eliminated or abated without endangering employees and/or property, personnel shall be removed from the area of potential exposure. Access shall be limited to personnel trained to correct the hazardous condition. Any employee(s) involved in correcting the hazardous condition shall have received appropriate training and shall be provided the necessary safeguards and protective equipment.
- C. After an investigation has been completed and the facts relating to the occurrence are known,



COUNTY OF EL DORADO, CALIFORNIA

BOARD OF SUPERVISORS POLICY

Subject: INJURY AND ILLNESS PREVENTION PROGRAM	Policy Number: K-1	Page Number: Page 13 of 15
	Date Adopted: 08/15/1986	Revised Date: 07/23/2019

immediate action to eliminate or abate any identified hazard and to prevent a recurrence of the hazard is the responsibility of the department head, who may request assistance from Risk Management.

- D. If a concealed hazard is identified, employees who have exposure to that hazard shall be informed immediately and the information shall be posted in the affected area. Immediate action shall be taken to eliminate or abate the hazard.

Training and Instruction

The objective of safety training at the County is to develop employee appreciation for safety and accident prevention as well as the skills and knowledge needed to bring about a reduction in the number and severity of illnesses and injuries. Each department is responsible for providing safety training to their employees. Training shall include safety requirements designed to instruct each employee on general and job specific safety procedures. All County employees will be trained by their supervisor and DSC in safe practices applicable to the performance of their work prior to assignment. Tailgate safety topics and refresher training will be provided as required to maintain regulatory compliance. Employees shall also receive safety training before exposure to a new risk or whenever the employee is given a job assignment for which safety training has not previously been provided.

Each supervisor and DSC will receive safety training appropriate to the responsibilities of the supervisory position held. Such training will include the basic techniques of accident prevention, accident investigation, and safety training. When a new employee begins employment, their supervisor shall ensure that they receive training on their work assignment while integrating safety instructions into each aspect of the job. This training is part of their new hire orientation and shall be documented on Attachment 2. Training shall include:

- A. Introduce the new employee to the workplace in general;
- B. Review the County and Department IIPP, as well as corresponding safety policies and procedures;
- C. Introduce the new employee to key safety personnel contacts for the department;
- D. Show the new employee their work area and discuss what the employee will be doing, including any hazards;
- E. Discuss safety and performance expectations;
- F. Provide the new employee with the necessary personal protective equipment and training on how to use the equipment;
- G. Monitor and counsel the new employee when tasks are not performed safely;



COUNTY OF EL DORADO, CALIFORNIA

BOARD OF SUPERVISORS POLICY

Subject: INJURY AND ILLNESS PREVENTION PROGRAM	Policy Number: K-1	Page Number: Page 14 of 15
	Date Adopted: 08/15/1986	Revised Date: 07/23/2019

- H. Show the new employee the emergency routes during an evacuation and the rally point; and
- I. Provide new employee with emergency contact phone numbers.

All training will be documented and records will be maintained per the County's Records Retention Policy. To ensure compliance by determining training frequency, specific Title 8 requirements can be found in Attachment 6 and at the following Cal/OSHA website: <http://www.dir.ca.gov/samples/search/query.htm>

Recordkeeping

Departments will maintain records of inspections and hazard reports for at least two years. Records must include the names of those who conducted the inspection, the dates of the inspection, the hazards that were identified and any corrective action that was taken.

Departments will maintain training records per the County's records retention schedule. Training records must include the names of the employees trained, the topics covered in the training, the date of the training, the trainer's identity, and signatures of employees who attended. Forms for documentation of training and inspections are available at the Risk Management office or on the intranet website.

Electronic training records are also acceptable. Because safety is an integral part of each employee's job, it is recommended that safety performance be considered in employee performance appraisals.

Employee records from medical monitoring and exposure evaluations will be preserved and maintained for the duration of employment plus t30 years. Employees and their designated representatives have a right to access relevant medical and exposure records.

Departments will maintain SDS'S for chemicals for 30 years unless an inventory, including the identity of the substance, where it was used and when it was used is retained for at least 30 years. The County's Hazard Communication Program specifies procedures for maintenance of SDS and chemical inventories.

REFERENCES

California Government Code §
8CCR1509 1 California Government
Code § 8CCR3203 California Labor
Code §6401.



**COUNTY OF EL DORADO, CALIFORNIA
BOARD OF SUPERVISORS POLICY**

Subject: INJURY AND ILLNESS PREVENTION PROGRAM	Policy Number: K-1	Page Number: Page 15 of 15
	Date Adopted: 08/15/1986	Revised Date: 07/23/2019

RESPONSIBLE DEPARTMENT

The responsible department for the County IIPP is the Human Resources Department, Risk Management Division. The Board of Supervisors hereby designates the Risk Manager as the individual with the authority and responsibility to develop and maintain an effective IIPP for the County of El Dorado.

DATES ISSUED AND REVISED; SUNSET DATES

Issue Date:	08/15/1986	Sunset Review Date:	XX/XX/XXXX
Revision Date:	XX/XX/XXXX	Sunset Review Date:	XX/XX/XXXX



COUNTY OF EL DORADO, CALIFORNIA

BOARD OF SUPERVISORS POLICY

ATTACHMENTS

1. Injury & Illness Prevention Program Review Sheet
2. Safety Orientation Checklist
3. Incident Report
4. Driver's Report of Accident
5. Safety Inspection Checklist
6. Safety and Health Training & Instruction Requirements

ATTACHED POLICIES

- | | |
|---|-------------------------------------|
| 1. AED Program | 10. Fire Prevention |
| 2. Aerosol Transmissible Disease | 11. Hearing Conservation |
| 3. Blood Borne Pathogens | 12. Heat Illness Prevention |
| 4. Bomb Threats and Suspicious Packages | 13. Hazard Communication |
| 5. Code of Safe Practices | 14. Hot Work |
| 6. Confined Spaces | 15. Lead Exposure control |
| 7. Crisis Communication Plan | 16. Office Safety |
| 8. Emergency Action Plan | 17. Respiratory Protection |
| 9. Ergonomics | 18. Trenching and Excavation Safety |



**COUNTY OF EL DORADO, CALIFORNIA
BOARD OF SUPERVISORS POLICY**

Attachment 1

Injury & Illness Prevention Program Review Sheet

Injury & Illness Prevention Program Review Sheet

Use this sheet to review the Departmental IIPP. If you answer No to any of the questions you will want to either update the IIPP or provide the training indicated

YES **NO**

		Does the written Injury and Illness Prevention Program contain the elements required by Section 3203(a)? See: http://www.dir.ca.gov/title8/3203.html
		Are the person or persons with authority and responsibility for implementing the program identified?
		Is there a system for ensuring that employees comply with safe and healthy work practices (i.e., employee incentives, training and retraining programs, and/or disciplinary measures)?
		Is there a system that provides communication with affected employees on occupational safety and health matter (i.e., meetings, training programs, posting, written communications, a system of anonymous notification concerning hazards and/or health and safety committees)?
		Does the communication system include provisions designed to encourage employees to inform the County of hazards at the worksite without fear of reprisal?
		Is there a system for identifying and evaluating workplace hazards whenever new substances, processes, procedures, or equipment are introduced to the workplace and whenever the employer receives notification of a new or previously unrecognized hazard?
		Are workplace hazards identified when the program was first established?
		Are periodic inspections for safety and health hazards scheduled?
		Are records kept of inspections made to identify unsafe conditions and work practices, if required?
		Is there an accident and near-miss investigation procedure?
		Are unsafe or unhealthy conditions and work practices corrected expeditiously, with the most hazardous exposures given correction priority?
		Are employees protected from serious or imminent hazards until they are corrected?
		Have employees received training in general safe and healthy work practices?
		Do employees know the safety and health hazards specific to their job assignments?
		Is training provided for all employees when the training program is first established?
		Are training needs of employees evaluated whenever new substances, processes, procedures, or equipment are introduced to the workplace and whenever the employer receives notification of a new or previously unrecognized hazard?

		Are supervisors knowledgeable of the safety and health hazards to which employees under their immediate direction and control may be exposed?
		Are records kept documenting safety and health training for each employee by name or other identifier, training dates, type(s) of training and training providers?
		Does the Department have a safety and health committee?
		Does the committee meet at least quarterly?
		Is a written record of safety committee meetings distributed to affected employees and maintained for Department review?
		Does the committee review results of the periodic, scheduled worksite inspections?
		Does the committee review accident and near-miss investigations and, where necessary, submit suggestions for prevention of future incidents?
		When determined necessary by the committee does it conduct its own inspections and investigations, to assist in remedial solutions?
		Does the committee verify abatement action taken by the County?



**COUNTY OF EL DORADO, CALIFORNIA
BOARD OF SUPERVISORS POLICY**

**Attachment 2
Safety Orientation Checklist**



County of El Dorado

Human Resources Department-Risk Management Division

www.edcgov.us

330 Fair Lane, Placerville, CA 95667

Phone: 530.621.5565 Fax: 530.642.9815 TDD: 530.621.4693

SAFETY ORIENTATION CHECKLIST

This form is to be completed by the supervisor of a new or reassigned* employee and returned to the Human Resources Department-Risk Management Division at riskmanagement@edcgov.us within 45 calendar days after assignment begins.

Employee: _____ Position: _____

Assigned Department: _____ Date Employed: _____

Completed Safety Items

- County Injury Illness and Prevention Program (IIPP)
- Department IIPP and Code of Safe Work Practices
 - Employee safety responsibilities and General Safety Rules
- Procedures for reporting work-related incidents
- Safety communication procedures; i.e. department safety coordinator, safety meetings, bulletin boards, incident forms
- Site-specific Emergency Action Plan (evacuation, First Aid kits, AED's, fire extinguishers, emergency phone numbers)

Completed Target Solutions Computer-Based Training (Scheduled through Human Resources)

- General Office Ergonomics
- Sexual Harassment Awareness
- Workplace Violence
- Driving Safety
- Injury Illness Prevention Policy
- Ethics (For supervisors and above only.)

**Employees reassigned to different departments must complete the Safety Items only.*

Additional Training Unique to Department (Scheduled through Safety Department Coordinators)

Please specify: _____

Employee/Volunteer Signature: _____ Date: _____

Supervisor Signature: _____ Date: _____



COUNTY OF EL DORADO, CALIFORNIA
BOARD OF SUPERVISORS POLICY

Attachment 3
Incident Report



County of El Dorado

Human Resources Department-Risk Management Division

www.edcgov.us

330 Fair Lane, Placerville, CA 95667

Phone: 530.621.5565 Fax: 530.642.9815 TDD: 530.621.4693

INCIDENT REPORT

Note: Vehicle accidents should be reported on the Driver's Report of Accident form.

INSTRUCTIONS

1. In cases involving extensive damage, call Risk Management at (530) 621-5565.
2. If appropriate, call the Local Law Enforcement Agency to file a report.
3. Photograph / preserve damaged property for investigation.
4. Complete appropriate sections for report type, forward to Risk Management within 24 hours of incident.

Type of Incident <small>(circle one)</small>	<input type="checkbox"/> General Public <small>(Citizens, Non-employee)</small>		<input type="checkbox"/> County Property Loss <small>(Theft, Vandalism, Damage)</small>		<input type="checkbox"/> Hazard <small>(Near-miss, Potential Safety Issue)</small>	
Incident Information	Date/Time:	Location:			Law Enforcement Agency & Report Number:	
Incident / Hazard Description*						
Person(s) Injured / Property Owner(s)	Name:			Address:		
	Phone:					
	Name:			Address:		
Phone:						
Estimated Replacement Cost					Inventory Number / ID Number:	
Proposed Corrective Action						
Witness Information <small>(if any)</small>	Name:			Address:		
	Phone:					

Report Information	Filed By:		Title:
	Department:		Date:
Supervisor Signature:			Date:
Risk Management Reviewer:			Date:
Action Taken:			

**If additional space is required or additional information is available, use a supplemental sheet of paper and attach.*



COUNTY OF EL DORADO, CALIFORNIA
BOARD OF SUPERVISORS POLICY

Attachment 4
Driver's Report of Accident



County of El Dorado

Human Resources Department-Risk Management Division

www.edcgov.us

330 Fair Lane, Placerville, CA 95667

Phone: 530.621.5565 Fax: 530.642.9815 TDD: 530.621.4693

DRIVER'S REPORT OF ACCIDENT

PRIVILEGED AND CONFIDENTIAL: Prepared in contemplation of litigation and for purposes of review and consultation with Risk Management and County Counsel. **ATTORNEY-CLIENT PRIVILEGED.**

1. This form is required whenever County vehicular equipment is involved in an accident causing any damage.
2. Call the appropriate law enforcement agency in all cases except when the accident involves only County equipment on County property and there are no injuries.
3. Only discuss the accident with a supervisor, law enforcement, or Risk Management.
4. Take photos and send with completed form to riskmanagement@edcgov.us and fleet.services@edcgov.us

ACCIDENT	Date		Law enforcement agency	CHP	Police	Sheriff
	Time		Officer name / Report #			
	Location					
	Brief Summary of Accident					
COUNTY VEHICLE				OTHER VEHICLE		
DRIVER	Name		DRIVER	Name		
	Phone			Phone		
	Department			Address		
	DL # / State			DL # / State		
VEHICLE	County vehicle #		VEHICLE	Year		
	Year & Make			Make		
	Model			Model		
	Plate #			Plate #		
	Vehicle towed?			Vehicle towed?		
WITNESS	Name		WITNESS	Name		
	Address			Address		
	Phone			Phone		
OTHER	Passenger name(s)		OTHER	Insurance Co.		
	Injured name(s)			Insurance policy #		
				Injured name(s)		

Label streets
 Label County vehicle as 1 Other vehicle as 2
 Label pedestrian(s) as O
 Show direction of travel:
Before accident
After accident



Indicate points of compass
 North, South, East, West



County of El Dorado

Human Resources Department-Risk Management Division

www.edcgov.us

330 Fair Lane, Placerville, CA 95667

Phone: 530.621.5565 Fax: 530.642.9815 TDD: 530.621.4693

Description of Accident:

Signature of County Driver

23-1257 A 26 of 219 ^{Date}



COUNTY OF EL DORADO, CALIFORNIA
BOARD OF SUPERVISORS POLICY

Attachment 5
Safety Inspection List

SAFETY INSPECTION LIST

Department: _____ Inspection Date: _____

Inspector's Name/Title: _____ Site Location: _____

Inspector's Email Address: _____ Phone #: _____

ADMINISTRATIVE SAFETY		Yes	No	N/A	Comments/Corrections/Notes
1	Is there an assigned safety representative for this department? If so, provide contact information.	<input type="checkbox"/>	<input type="checkbox"/>	<input type="checkbox"/>	
2	Is there a safety binder/IIPP in each site location accessible to all employees?	<input type="checkbox"/>	<input type="checkbox"/>	<input type="checkbox"/>	
3	Are Safety/Labor Law posters and safety bulletin boards with safety related materials and emergency phone numbers posted?	<input type="checkbox"/>	<input type="checkbox"/>	<input type="checkbox"/>	
4	Is there a Safety Data Sheet (SDS) binder for the department in a central location?	<input type="checkbox"/>	<input type="checkbox"/>	<input type="checkbox"/>	
5	Are current evacuation maps located in all public access areas/rooms?	<input type="checkbox"/>	<input type="checkbox"/>	<input type="checkbox"/>	
6	Are there written records of department safety training and regular fire drills? When was the last drill conducted (if known)?	<input type="checkbox"/>	<input type="checkbox"/>	<input type="checkbox"/>	
GENERAL FIRE SAFETY/HOUSEKEEPING		Yes	No	N/A	Comments/Corrections/Notes
7	Does the department have proper first aid kits available, adequately supplied (without medication such as Ibuprophen etc. which should not be in the first aid kit)?	<input type="checkbox"/>	<input type="checkbox"/>	<input type="checkbox"/>	
8	Are filing cabinets, bookcases, and other items over 4 feet tall securely placed to prevent tipping hazard?	<input type="checkbox"/>	<input type="checkbox"/>	<input type="checkbox"/>	
9	Are boxes and heavy materials above chest level secured and marked legibly 'heavy item'?	<input type="checkbox"/>	<input type="checkbox"/>	<input type="checkbox"/>	
10	Are items that are stored overhead lightweight? If not, can they be moved to chest level or below?	<input type="checkbox"/>	<input type="checkbox"/>	<input type="checkbox"/>	
11	Are cubicle walls secure? Are shelves secured and stable?	<input type="checkbox"/>	<input type="checkbox"/>	<input type="checkbox"/>	
12	Are office areas organized and maintained to avoid tripping hazards? Note problem areas.	<input type="checkbox"/>	<input type="checkbox"/>	<input type="checkbox"/>	
13	Are sturdy stepladders available and in proper working order?	<input type="checkbox"/>	<input type="checkbox"/>	<input type="checkbox"/>	
14	Is there adequate lighting throughout the building, including storage and entrance lighting?	<input type="checkbox"/>	<input type="checkbox"/>	<input type="checkbox"/>	
15	Are light fixtures clean and in proper working order with appropriate covers?	<input type="checkbox"/>	<input type="checkbox"/>	<input type="checkbox"/>	
16	Are ceilings and walls free of holes?	<input type="checkbox"/>	<input type="checkbox"/>	<input type="checkbox"/>	
17	Are adequate waste receptacles appropriate for worksite needs? Special attention to healthcare areas and sharps containers.	<input type="checkbox"/>	<input type="checkbox"/>	<input type="checkbox"/>	
18	Is flooring/carpeting in good condition, with loose rugs and mats secured? Snags in carpet need repair?	<input type="checkbox"/>	<input type="checkbox"/>	<input type="checkbox"/>	

19	Are paper cutters equipped with guards and closed?	<input type="checkbox"/>	<input type="checkbox"/>	<input type="checkbox"/>	
20	Are restrooms clean, with hand washing signs, soap, towels, and toilet paper? Is hand sanitizer available in multiple locations for clients and staff?	<input type="checkbox"/>	<input type="checkbox"/>	<input type="checkbox"/>	
21	Do all electric fans have a grill or guard for finger protection?	<input type="checkbox"/>	<input type="checkbox"/>	<input type="checkbox"/>	
22	Are stairwells unobstructed? Are non-skid materials used on steps whenever possible? Are railings in good repair, tightly secured to the wall?	<input type="checkbox"/>	<input type="checkbox"/>	<input type="checkbox"/>	
23	Are fire doors marked and kept securely closed at all times?	<input type="checkbox"/>	<input type="checkbox"/>	<input type="checkbox"/>	
24	Are exit signs in appropriate locations and working properly?	<input type="checkbox"/>	<input type="checkbox"/>	<input type="checkbox"/>	
ELECTRICAL SAFETY		Yes	No	N/A	Comments/Corrections/Notes
25	Are electrical rooms clearly marked with appropriate signs?	<input type="checkbox"/>	<input type="checkbox"/>	<input type="checkbox"/>	
26	Are all multi-plug extension outlets UL approved surge suppressors or protectors (not power strips or taps)?	<input type="checkbox"/>	<input type="checkbox"/>	<input type="checkbox"/>	
27	Are any UL approved surge suppressors or protectors plugged in to another UL approved surge protector (as this is a safety hazard)?	<input type="checkbox"/>	<input type="checkbox"/>	<input type="checkbox"/>	
28	Are all circuit breakers clearly labeled and free of tape or any other obstruction that may prevent them from functioning properly?	<input type="checkbox"/>	<input type="checkbox"/>	<input type="checkbox"/>	
29	Has a clear access of at least 30 inches in width, 78 inches in height, and 36 inches in front of all electrical panels been provided?	<input type="checkbox"/>	<input type="checkbox"/>	<input type="checkbox"/>	
30	Are all circuit breaker spaces in the power panel covered?	<input type="checkbox"/>	<input type="checkbox"/>	<input type="checkbox"/>	
31	Are all breakers in the power panel properly labeled?	<input type="checkbox"/>	<input type="checkbox"/>	<input type="checkbox"/>	
32	Is there at least 30 inches of clearance around hot water heaters, heating units, and heat-producing appliances?	<input type="checkbox"/>	<input type="checkbox"/>	<input type="checkbox"/>	
33	Do all electrical outlets, switches, and junction boxes have cover plates? Are they in good repair (not broken, showing signs of arcing, or overheating)?	<input type="checkbox"/>	<input type="checkbox"/>	<input type="checkbox"/>	
34	Are there any exposed electrical wires in need of repair?	<input type="checkbox"/>	<input type="checkbox"/>	<input type="checkbox"/>	
35	Are electric heaters plugged directly into a wall plug, not an extension cord? Are they placed at least three feet away from combustible materials and have adequate ventilation space?	<input type="checkbox"/>	<input type="checkbox"/>	<input type="checkbox"/>	
KITCHEN & FIRE SAFETY (If applicable)		Yes	No	N/A	Comments/Corrections/Notes
36	Are the kitchen hood, duct, filters, exhaust fans, and suppression system heads clean (free of grease build up) and working properly?	<input type="checkbox"/>	<input type="checkbox"/>	<input type="checkbox"/>	
37	Are the protective caps installed on all sprinkler heads over the cooking equipment (applies to kitchen hood suppression systems only)?	<input type="checkbox"/>	<input type="checkbox"/>	<input type="checkbox"/>	
38	Has the hood and duct fire extinguishing system been serviced and tagged in the last 6 months?	<input type="checkbox"/>	<input type="checkbox"/>	<input type="checkbox"/>	

39	Does the kitchen appear clean and in good working order?	<input type="checkbox"/>	<input type="checkbox"/>	<input type="checkbox"/>	
COMBUSTABLE MATERIAL & FIRE SAFETY		Yes	No	N/A	Comments/Corrections/Notes
40	Are compressed gas cylinders secured so they cannot be knocked over?	<input type="checkbox"/>	<input type="checkbox"/>	<input type="checkbox"/>	
41	Do fuel tanks have proper warning signs?	<input type="checkbox"/>	<input type="checkbox"/>	<input type="checkbox"/>	
42	Are fuel tank emergency disconnect switches marked and easily accessible?	<input type="checkbox"/>	<input type="checkbox"/>	<input type="checkbox"/>	
43	Are combustible materials stored in assigned storage cabinets or designated areas, and are MSD sheets on file for each item?	<input type="checkbox"/>	<input type="checkbox"/>	<input type="checkbox"/>	
44	Is combustible storage at least 24 inches below the ceiling in non-sprinklered rooms and 18 inches below the ceiling in sprinklered rooms?	<input type="checkbox"/>	<input type="checkbox"/>	<input type="checkbox"/>	
45	Are materials susceptible to spontaneous ignition, such as oily rags, kept in an approved noncombustible container with a self-closing lid?	<input type="checkbox"/>	<input type="checkbox"/>	<input type="checkbox"/>	
46	Are boiler rooms, mechanical rooms, and electrical rooms maintained free of all combustible materials?				
FIRE EXTINGUISHER SAFETY		Yes	No	N/A	Comments/Corrections/Notes
47	Have fire extinguishers been serviced and tagged in the last year?	<input type="checkbox"/>	<input type="checkbox"/>	<input type="checkbox"/>	
48	Are fire extinguishers mounted in an easily accessible location?	<input type="checkbox"/>	<input type="checkbox"/>	<input type="checkbox"/>	
49	Have fire extinguishers been inspected by office personnel each month and initialed?	<input type="checkbox"/>	<input type="checkbox"/>	<input type="checkbox"/>	

Necessary Corrections/Repairs/Replacement/Comments: _____

Necessary Work Orders/When Submitted? _____

Inspector's Signature: _____ **Date:** _____

Correction Follow Inspection Date (approximately 2 weeks for minor issues): _____

Forwarded to Department Head/Designee for Review on: _____

Department Head Comments/Directions for Follow-Up:

Department Head Approval: _____ **Date:** _____

Forwarded to Risk Management on: _____

Risk Management Follow-Up Comments: _____

Risk Management Approval as to Form Only: _____ **Date:** _____

Date Safety Inspection File Closed: _____



COUNTY OF EL DORADO, CALIFORNIA
BOARD OF SUPERVISORS POLICY

Attachment 6
Training and Instruction Requirements

**SAFETY AND HEALTH
TRAINING AND INSTRUCTION REQUIREMENTS**
*REFERENCED IN SUBCHAPTER 4 & 7, TITLE 8, CALIFORNIA CODE OF REGULATIONS
(August 2006)*

The following is a list of the *instruction and training* requirements contained in the **Construction Safety Orders** (Subchapter 4) and the **General Industry Safety Orders** (Subchapter 7) of Title 8, Division 1, Chapter 4 (with several references contained in Chapter 3.2) of the California Code of Regulations. Also included are references to both Competent Person and Qualified Person.

While every effort has been made to ensure the accuracy of the information presented, users are cautioned to refer to Title 8 and the specific sections of interest. This list is a guide only and not meant to be a substitute for –or a legal interpretation of– the occupational safety and health standards.

Users may review Title 8 Regulations at: <http://www.dir.ca.gov/samples/search/quer.htm>

TRAINING TOPIC	T8 SECTION	FREQUENCY OF TRAINING	TYPICAL JOB CLASSIFICATION	Cal/OSHA PUBLICATION
Accident Investigation	3203(a)(7)(F)	Initial	Supervisors/Accident Investigators	Model Program(s) IIPP: For High Hazard Employers For Non-High Hazard Employers For Employers with Intermittent Employees For Employers with Intermittent Workers in Agriculture (English & Spanish) Guide to Developing IIPP
Accident Prevention Signs and Tags	3341(d)(5)	Initial	Impacted Employees	Lockout/Blockout
Acetylene & Fuel Gas Safety	1740(k)(1)	Initial	Users	
Acrylonitrile (AN)	5213(o) 5213 (appendix B)	Initial Annual	Exposed Employees Qualified Person	
Actinolite (Non-Asbestos)	5208.1	Initial Annual	Exposed Employees	
Agricultural Equipment & Tractors	3441(a) 3664(b)	Initial Annual	Involved Employees Operators	Agricultural-Industrial Tractors Farm Labor Contractors Guide

TRAINING TOPIC	T8 SECTION	FREQUENCY OF TRAINING	TYPICAL JOB CLASSIFICATION	Cal/OSHA PUBLICATION
Anthophyllite (Non-Asbestos)	5208.1(n)	Initial Annual	Exposed Employees	
Asbestos/Asbestos Awareness	1529(k)(9)(B) 5208(j)(7)(B) 1529	Initial Annual	Employees likely exposed => PEL and those who perform Class I-IV operations	
Class I-IV Operations	1529(o)(4) 341.9	Initial Annual	Competent Person Qualified Person	
Building Inspector Project Designer	341.16	Initial	Assigned	
Cement Pipe	341.17	Initial	Exposed Employees	
Asbestos Consultant Site Surveillance Technician	341.15	Initial	Certified Persons	
Battery Handling/ Changing/Charging	5185(a)	Initial	Assigned Employees	
Benzene	5218(i) & (j)(3)	Initial Annual	Exposed Employees	
Bloodborne Pathogens	5193(g)(2)	Initial Annual	Potentially Exposed Employees	Best Practices Approach for Reducing Bloodborne Pathogens Exposure Exposure Control Plan for Bloodborne Pathogens
Boatswains Chair	1662(a)	Initial	Users	
1,3-Butadiene	5201(l)(2)	Initial Annual	Exposed Employees	
Cadmium	5207(m)(4) 1532	Initial Annual	Exposed Employees Competent Person	
Carcinogens As Listed	5209(e)(5)	Initial	Exposed Employees	
Chemical Hygiene for Laboratories	5191(f)(2)	Initial New Hazards Refresher	Laboratory Employees	
Coke Oven Emissions	5211(t)	Initial Annual	Exposed Employees	
Compaction Equipment	4355(a)(2)	Before Use	Users	
Confined Spaces	5157(g) 5158(c)(2)	Initial Program Update Changes	Affected Employees	Confined Space: Is It Safe To Enter
Marine Terminal Operations	3463(b)(5)(B)		Exposed Employees	
Cotton Gins/ Processing Mach.	4646		Qualified Person	
Control of Hazardous Energy	3314(j)	Initial	Authorized Employees	Lockout/Blockout

TRAINING TOPIC	T8 SECTION	FREQUENCY OF TRAINING	TYPICAL JOB CLASSIFICATION	Cal/OSHA PUBLICATION
Cranes & Other Hoisting Equipment Incl. Mobile/Tower/Derrick	5006.1(a) 5006 4966,4994, 4999,5000, 5004, 5031,5043, 5044	Initial Mobile & Tower Cert. @ 5 yrs	Mobile and Tower Crane Operators Qualified Person Authorized Employees	
Cranes/Hoisting Equipment - Marine Terminals	3472(d)(3)	Initial	Operators	
Demolition	1734 1735(u) 1736		Qualified Person	
1,2 Dibromo-3-Chloropropane (DBCP)	5212(i)(3) & (n) 5212 (Appendix B)	Initial Annual	Exposed Employees Qualified Person	
Diving Operations	6052	Initial	Assigned Employees	
Elevating Work Platforms and Aerial Devices	3648(i)(7) 3648(c) 3646(c) 3638(d)	Before Use	Users Authorized Personnel	
Emergency Action Plan	3220(e)	Initial Plan Update	Impacted Employees	
Emergency Procedures (Construction)	1512(d)	Initial	Assigned Employees	
Equipment and Machinery (Construction)	1510(b)	Initial	Qualified Person	
Erection and Construction – Bolting/Riveting/ Plumbing Structural Wood/ Steel Frame Steel Erection	1716 1716.1 1716.1(f)(1) 1716.2(i) 1710	Initial	Assigned Employees Competent person Qualified Person	Pocket Guide for the Construction Industry (English/Spanish) (Spanish Update Sheet)
Ergonomics	5110(b)(3)	Initial – When Standard is Triggered	Employees in affected job classifications (identical jobs) when standard is triggered	Back Injury Prevention Guide in the Health Care Industry for Health Care Providers Easy Ergonomics Ergonomics in Action Fitting Task to the Person: Ergo for the Very Small Business Easy Ergo for the Computer User
Ethylene Dibromide (EDB)	5219(j)	Initial Annual	Exposed Employees	

TRAINING TOPIC	T8 SECTION	FREQUENCY OF TRAINING	TYPICAL JOB CLASSIFICATION	Cal/OSHA PUBLICATION
Ethylene Oxide	5220(j)(3) 5220 Appendix A	Initial Annual	Exposed Employees	
Excavation/ Trenching/Shoring	1541		Competent Person	Trenching Safety (Tailgate Topic) Pocket Guide for the Construction Industry
Explosives	5239 5322 5329 344.20, 344.21	Initial	Assigned Employees Competent Person Licensed Blaster	
Explosives – Deteriorated	5240		Competent Person	
Explosives Storage Magazines	5256		Competent Person	
Fall Protection	1671.1	Initial	Affected Employees Competent Person Qualified Person	
Fall Protection – Date Palm Ops.	3458		Competent Person	
Fire Brigades (Private)	3411(c)	Initial/Quarterly/ Annual Refresher	Assigned Employees	
Fire Extinguisher & Fire Fighting Equipment	6151(g)(1)-(2)	Initial Annual	Assigned Employees	
Fire Prevention Plan	3221(d)(1)-(2)	Initial New Hazards	Exposed Employees	
Fire Protection – Fixed Extinguishing Systems	6175(b)(10) 6181(b)(2)	Initial Annual	Employees Assigned Maintenance/Operation Exposed Employees	
Fire Protection – Standpipe & Hose System Inspection	6165(f)(2)(F)	Initial	Assigned Employees	
First Aid First Aid & CPR	3439(b) 6251(d)(2) 3400(b) 5157, 5158, 5193 3421, 6052	Initial Changes Every 2 years (or as specified by cert. organization)	Assigned Employees Supervisors	
First Aid (Construction)	1512(b) & (d)	Initial Updated	Assigned Employees	
Flaggers (Traffic)	1599(f) & (g)	Initial	Assigned Employees	
Flammable Liquids/ Gasses/Vapors – Industrial Plants	5561		Qualified Person	
Formaldehyde	5217(n)	Initial Annual	Exposed Employees	
Fumigation – General	5221(b)	Initial	Exposed Employees	

TRAINING TOPIC	T8 SECTION	FREQUENCY OF TRAINING	TYPICAL JOB CLASSIFICATION	Cal/OSHA PUBLICATION
Hazard Communication	5194(b)(1)	Initial New chemicals or processes	Exposed Employees	Guide to CA Hazard Communication Regulation
Hazardous Substance Containers Clean/Repair/Alter	5166(a)	Initial	Assigned Employees	
Hazardous Waste Operations & Emergency Resp.	5192 (e) & (q)(6)	Initial Annual Refresher	Assigned Employees Qualified Person	
Hearing (Noise) Protectors	5098(a)(4) 5097(d)(5)(A)&(B)	Initial Retraining	Employees Provided Protectors	
Conservation	5099(a)	Initial Annual	All Employees Exposed to =>85 dBA TWA	
Heat Stress	3395(e)	Initial	Exposed Employees	Protect Yourself from Heat Illness (English/Spanish)
Helicopter Operations	1901(c)	Daily Briefing	Involved Personnel	
Industrial/Lift Trucks (Forklifts) & Tractors	3657(i) 3664(b) 3668	Initial, Annual Observed Unsafe Operation Post Accident Equipment Change Workplace Change (Operator eval. @ 3 years)	Operators	Operating Rules for Industrial Trucks Poster (English/Spanish)
Injury & Illness Prevention Program	3203(a)(7) 1509(e)	Initial Updated	All Employees Supervisor Tailgates	Model Program(s) IIPP For High Hazard Employers For Non-High Hazard Employers For Employers with Intermittent Employees (English/Spanish) For Employers with Intermittent Workers in Agriculture (English & Spanish) Guide to Developing IIPP
Inorganic Arsenic	5214(m)	Initial Annual	Exposed Employees	

TRAINING TOPIC	T8 SECTION	FREQUENCY OF TRAINING	TYPICAL JOB CLASSIFICATION	Cal/OSHA PUBLICATION
Job Hazard(s)	3203(a)(7) 1510(a) & (c)	Before Job Assignment New Hazards	All Employees	Guide to Developing IIPP
Laboratory Safety (See Chemical Hygiene)	5191(f)	Initial New Hazards Refresher	Laboratory Employees	
Laser Equipment	1801(a)	Initial	Operators Qualified Person	
Laundry/Dry Cleaning	4494(a)	Initial Periodic	Assigned Employees	
Lead Lead in Construction	5198(f) 1531.1(f)(1)(C)-(D) 1532.1(f)	Initial Annual	Exposed Employees/ Supervisors Exposed Employees => Action Level	Lead in Construction (Fact Sheet)
Lift Slab Construction	1722.1		Competent Person	
Lockout/Blockout	3314 3314(j)	Initial When Updated	Affected Employees Qualified Person	Lockout/Blockout
Machinery and Equipment	1510(b)	Before Use	Qualified Person	Lockout/Blockout
Marine Terminals	3463(b)(5)(B) 3464(a)(1) 3462(b) & (d) 3463, 3472	Initial	Exposed Employees Supervisors Qualified Person	
Medical & Exposure Records - Access	3204(g)(1)	Initial Annual	Affected Employees	Access to Medical and Exposure Records (poster) (English/Spanish)
Metal Working (forging) Machines	4243(a)(6)	Initial	Operators/Maintenance Personnel	Power Press Safety – Tool Box Topics
4,4-Methylenebis (2-Chloroaniline) MBOCA	5215(j)	Initial Annual	Exposed Employees	
Methylene Chloride	5202(f) 5202 (Appendix A)	Initial & As Necessary	Exposed Employees Qualified Person	
Methylenedianiline	5200(k)(3) 1535	Initial Annual	Exposed Employees	
Miter Saws	4307.1(c)	Initial	Operators	
Noise Exposure	5099(a)	Initial Annual	Employees Exposed = > 85dBA TWA	
Openings/Holes – Floors and Roofs	3212(b)		Qualified Person	
Paper Converting/ Printing Machines – Hand-Fed Engraving Presses	4445(3)	Initial Changes	Operators/Maintenance Personnel	
Personal Fall Arrest/Restraint Systems	1670(b)(19)		Competent Person	
Personal Protective Equipment	3380(c)	Initial	PPE Users	

TRAINING TOPIC	T8 SECTION	FREQUENCY OF TRAINING	TYPICAL JOB CLASSIFICATION	Cal/OSHA PUBLICATION
Pesticide Safety	5194(h)	Initial New Hazards	Handlers & Applicators	
Pile Driving	1600		Competent Person	
Calif. Posting Requirements	340	Initial	All Employees	
Powder-Actuated Tools	1685(a)(1) 1689(a)	Initial	Users Qualified Person	
Power Presses	4203(a) 4203(b) 4208.1(m)(1) 4208	Initial Annual	Inspectors/Maintenance Operators PSDI Operators Qualified Person	Power Press Safety (Tailgate Topic)
Powered Platforms (Installed) for Building Maintenance	3298(a) 3296	Initial	Assigned Employees Qualified Person	
Process Safety Management	5189(g)	Initial Refresher & Supplemental Certification	Involved Employees	
Pulp, Paper and Paperboard Mills	4402	Initial	Exposed Employees	
Railroad – Signs & Signals	3333(d)	Initial	Assigned Employees	
Reinforcing Steel/Similar Projections	1712(f)(A)		Qualified Person	
Respiratory Protection	5144(c) & (k) 5144 Appendix A & C	Initial Annual	Users	Resp. Protection in the Workplace New Respirator Reg. (Fact Sheet)
Roofing	1509(a) 1730(b)(8)-(9)	Initial	Qualified Person	Roofing Safety (Tailgate Topic)
Rope Access Equipment	3270.1(c) 3270.1	Initial Annual Refresher	Assigned Employees Qualified Person	
Rubber/Composition Working Machines	4592		Competent Person Test/Maintenance	
Scaffolds	1637(k)(1) 1637 1658(g)	Initial	Erectors and Dismantlers: Qualified Person	
Supervisory Safety Training	3203(a)(7)(F)	Initial Change	Supervisors	
Tanks – Open Surface	5154(j)(1)	Initial	Assigned Employee	
Traffic Control – Flaggers	1599(f) & (g)	Initial	Flaggers	
Tree Work General Date Palm Ops.	3420(b), 3421(c) 3423(a), 3427 3428(a) 3458	Initial	Assigned Employees Qualified Person	
Tremolite (Non-Asbestos)	5208.1(n)	Initial Annual	Exposed Employees	
Vinyl Chloride	5210(j)	Initial Annual	Exposed Employees	

TRAINING TOPIC	T8 SECTION	FREQUENCY OF TRAINING	TYPICAL JOB CLASSIFICATION	Cal/OSHA PUBLICATION
Welding & Cutting Safety – Hot Work	4799 4848(a) 1537(a)	Initial	Welders Fire Watchers Qualified Person	
Wheels or Rims – Servicing	3326(c)	Initial	Service Personnel	Servicing Single, Split Rim & MultiPiece Rim Wheel (Tailgate Topic)
Window Cleaning	3282(d) &(f) 3286(a)(2)	Initial	Assigned Employees	

Qualified Person

A qualified person is a person **designated** by the employer; and by reason of **training**, experience, or instruction has demonstrated the ability to perform safely **all** assigned duties; and, when required is properly licensed in accordance with federal, state, or local laws and regulations.

Examples: **Mobile Crane** and Tower Crane Operators 5006.1(a)
Scaffold Erection and Dismantling Supervisors 1637(k)(1)
Demolition 1736

Competent Person

A competent person is a person who is **capable** of identifying existing and predictable hazards in the surroundings or working conditions that are unsanitary, hazardous, or dangerous to employees. The competent person has the **authority** to impose prompt corrective measures to eliminate these hazards.

Examples: **Excavation** - Inspectors 1541
Fall Protection Plan implementers and supervisors 1671.1
Lift Slab Construction 1522.1

The Cal/OSHA Publications website contains additional publications that may be of interest. To review, download, or order free educational materials, go to:

www.dir.ca.gov/dosh/puborder.asp



COUNTY OF EL DORADO, CALIFORNIA
BOARD OF SUPERVISORS POLICY

Attached Policies



COUNTY OF EL DORADO, CALIFORNIA

BOARD OF SUPERVISORS POLICY



County of El Dorado, California

Regulatory Compliance Program No. 1 Automated External Defibrillators

I. Purpose and Scope

The written regulatory compliance program (RCP) establishes the procedures and training guidelines for County of El Dorado personnel assigned as lay rescuers to use automated external defibrillators (AEDs) in County facilities or at County functions. This RCP is in compliance with the Health and Safety Code, Sections 1797.190 and 1797.196.

Under California Civil Code, Section 1714.21, the State of California provides protection from civil damages to entities that acquire an AED for emergency use as long as the entity has complied with subdivision (b) of Section 1797.196 of the Health and Safety Code. Individuals using an AED or performing cardiopulmonary resuscitation (CPR) are protected from civil damages if they provide emergency care or treatment in good faith and do not expect compensation. These protections do not apply in the case of personal injury or wrongful death resulting from the gross negligence, willful, or wanton misconduct of the person who renders emergency care or treatment by the use of an AED. Definitions of the terms used in this RCP are found in Attachment A.

II. Responsibilities

A. The County of El Dorado (County) AED program manager will:

1. Be responsible for the overall coordination, implementation, and continued operation of this program;
2. Ensure that the County AED RCP complies with all federal, state, and local regulations;
3. Be available in person or by phone to answer any questions or concerns of site managers or authorized individuals;
4. Ensure that issues related to training, scheduling of basic and periodic reviews, maintenance of training standards and authorized individual training, and recordkeeping are managed on a continuing basis;
5. Maintain a list of the appropriate contact information for each department site manager and forward this information to an agent of the local emergency medical services (EMS) agency (Attachment B);
6. Notify the local EMS agency of the existence, location, and type of each AED acquired at each AED site;
7. Maintain all equipment and keep related supplies stocked in accordance with manufacturers' recommendations, inclusive of completing regular inspections (after every use and at least every 90 days), testing, changing battery and pads as required, and notifying the site manager when supplies need to be reordered. The program manager will maintain a log indicating where each AED for the site is located, the dates of routine maintenance, the dates of routine testing, expiration dates of battery and pads, current AED protocols from the manufacturer, and any



COUNTY OF EL DORADO, CALIFORNIA BOARD OF SUPERVISORS POLICY

and all uses of each AED (Attachment D);

8. Provide/approve the training curriculum along with the written and/or skills tests for AED use;

1

9. Ensure the employees are certified by American Heart Association (AHA) or American Red Cross (ARC) standards to perform Basic Life Support (BLS)-CPR, and to utilize an AED;
 10. Review reports of uses of AEDs and provide feedback regarding each use to the Site Managers, who in turn will review this information with the appropriate staff in order to improve performance of individuals as well as the AED program in general;
 11. Maintain a list of all trained County lay rescuers who are certified in CPR/AED that are currently participating in the AED program, and;
 12. At least once per year, offer a demonstration to at least one person associated with the building so that the person can be walked through how to use an AED properly in an emergency.
- B. The department site manager will:
1. Develop and implement a written internal emergency response plan. Attachment C is a checklist for the components required in this plan;
 2. Ensure that employees are familiar with the internal emergency response plan;
 3. At least once per year, notify the tenants as to the location of the AED units and provide information to tenants about who they can contact if they want to voluntarily take CPR/AED training;
 4. Have at least one trained and certified employee on duty during business hours and ensure that there are a reasonably sufficient number of employees trained in CPR/AED. At least one person needs to be trained and certified for up to five AED units on site;
 5. Maintain all equipment and keep related supplies stocked in accordance with Title 22 requirements and manufacturers' recommendations. This includes the Human Resources Department - Risk Management Division (Risk Management) completing regular inspections (after every use and/or at least every 90 days), testing, maintenance, and battery changes as required, and notifying the site manager when supplies need to be reordered;
 6. Immediately remove any AED from service after it is utilized and replace it with a spare if available. The original unit will be returned to service after it has been inspected and maintained per the manufacturer's requirements. Utilization is defined as any instance in which an AED is turned on for anything but routine maintenance or battery change;
 7. Notify Risk Management as soon as possible following the utilization of an AED, and;
 8. Ensure that, when initiating a spare unit or when returning a unit to service, a routine maintenance and battery check is performed and documented in the maintenance log.
- C. Authorized Individuals/Employees will:
1. Complete a basic CPR course according to the standards set forth by the AHA or the

ARC. Employees will have CPR certification prior to undertaking AED training or obtain CPR training concurrently with AED training;

2. Undergo annual training and skills proficiency demonstration that will be no less than one hour in duration;
3. In order to be eligible to use an AED on an appropriate patient, meet the training requirements, pass competency-based written and/or skills recognition examinations, and comply with all requirements set forth in these policies and procedures. Failure to comply with these requirements will result in the suspension of the individual's authorization, and;
4. Adhere to all training requirements and procedures written in this program.

III. Training Requirements

The training requirements for authorized individuals are outlined below. The training course will consist of not less than four hours and will comply with the AHA or ARC standards. The required hours for an AED training program can be reduced by no more than two hours for students who can show they have been certified in a basic CPR course in the past year and demonstrate that they are proficient in the current techniques of CPR.

1. The full four-hour course will include the following topics and skills:
 - a. Basic CPR skills;
 - b. Proper use, maintenance, and periodic inspection of an AED;
 - c. The importance of early activation of the internal emergency response plan, early CPR, early defibrillation, early advanced life support;
 - d. How to recognize the warning signs of heart attacks and strokes;
 - e. Overview of the local EMS system, including 9-1-1 access, and interaction with EMS personnel;
 - f. Assessment of an unconscious patient to include evaluation of airway, breathing, and circulation, to determine if cardiac arrest has occurred and the appropriateness of applying and activation of an AED;
 - g. Information relating to defibrillator safety precautions to enable the individual to administer shocks without jeopardizing the safety of the patient or the authorized individual or other nearby persons to include, but not limited to, the age and weight restrictions for the use of the AED, the presence of water or liquid on or around the victim, and/or the presence of transdermal medications, implanted pacemakers or automatic implanted cardioverter- defibrillators;
 - h. Recognition that an electrical shock has been delivered to the patient and that the defibrillator is no longer charged;
 - i. Rapid, accurate assessment of the patient's post-shock status to determine if further activation of the AED is necessary; and
 - j. Authorized individual's responsibility for continuation of care, such as the

repeated shocks if necessary, and/or accompaniment to the hospital, if indicated, or until the arrival of professional medical personnel.

2. All successful participants will receive a CPR/AED course completion card.
3. The required course materials will meet the standards of the AHA or the ARC, although they do not necessarily have to be the AHA or ARC materials. Testing will include a competency demonstration of skills on a manikin observed by the instructor.
4. Basic and review sessions will be conducted at least every other year for CPR/AED renewal and periodic reviews will be at the discretion of the Medical Director, with a one-year minimum. Reviews may be scheduled more often if necessary.
5. Training records will be maintained by the department and will include documentation of defibrillation skills proficiency.

IV. Procedures and Post-Incident Reporting Requirements

Authorized individuals will adhere to the following procedures and requirements per their training:

1. Assessment

Upon learning that an employee or a member of the public is ill, the authorized individual employee will quickly assess the patient. The responder will determine the patient's level of consciousness and assess them for airway, breathing, and circulation.

2. Call 911

If using a land-line telephone, dial 9-1-1. If calling from a cell phone, dial 626-4911.

3. CPR, Defibrillate, and Monitor

- a. If the patient is unconscious and the authorized individual cannot tell if the patient has a pulse or is breathing, the authorized individual will direct someone to get the AED as quickly as possible and bring it to the patient's side. The authorized individual will perform CPR until the AED arrives.
- b. Once the AED is at the patient's side, the authorized individual will expose the patient's chest, activate the AED, and follow the AED protocol exactly until EMS arrives.
- c. If the patient begins breathing on his/her own, the authorized individual will not perform CPR, but will monitor the patient closely for changes in breathing or pulse until EMS arrives.
- d. If the AED does not recommend shocking the patient, but the patient is unconscious, not breathing, and there is no discernible pulse, the authorized individual will continue CPR until EMS arrives.
- e. The authorized individual will continue to follow AED prompts and perform CPR until EMS takes over.

4. EMS Arrival

The authorized individual will document and communicate important information to EMS personnel, including the patient's name, time patient was found, initial and current condition of the patient and any other pertinent information. The authorized individual may be asked to assist EMS personnel.

5. Post-Incident Reporting and Follow-Up

The authorized individual who worked on the patient should document the incident using the AED Post-Incident Report form (Attachment E) as soon as possible after the event.

Documentation will be completed whether or not defibrillator shocks were delivered. Site managers will ensure access to the AED data, and provide the AED Post-Incident Report and any other relevant documentation to the program manager within 24 hours of the event.

The program manager will take the AED out of service immediately after the event, download any event data from the AED, and be sure not to remove the battery. Risk Management will conduct or arrange for a critical incident debriefing if needed. If grief counseling is deemed necessary, referrals may be made to the Employee Assistance Program (EAP).

The program manager and site manager will review the AED record of the event and the AED Post-Incident Report, and interview the authorized individuals involved in the emergency as necessary to ensure that:

- a. The authorized individuals quickly and effectively set up the necessary equipment;
- b. When indicated, the initial defibrillator shock(s) was delivered within an appropriate amount of time given the particular circumstances;
- c. Adequate basic life support measures were maintained;
- d. Following each shock or set of shocks, as appropriate, the person was assessed accurately and treated appropriately;
- e. The defibrillator was activated safely and correctly, and;
- f. The care provided was in compliance with the internal emergency response guidelines set forth in this document.

Quality assurance will be maintained by way of evaluation of the medical care rendered by the authorized individuals on scene and during transfer of the patient or by the appropriate transporting agency personnel.

The program manager will evaluate the occurrence and recommend the range of action to be taken in response to identified problems or deficiencies.

Following the post-incident review, a copy of all written documentation concerning the incident will be sent to the program manager and maintained on site for a period of not less than seven years from the incident date.

V. Program Evaluation

The County AED program manager will issue a report every 12 months regarding the activities of the AED program and will make the report available to departments. The program manager will review this RCP at least annually, and will make revisions to this document as necessary.

Attachment A Definitions

Automated External Defibrillator (AED)

An external defibrillator that after user activation is capable of cardiac rhythm analysis. The AED will charge and deliver a shock, either automatically or by user interaction, after electronically detecting and assessing ventricular fibrillation or rapid ventricular tachycardia.

AED Consultant

Representative of the AED manufacturer.

AED Service Provider

Any agency, business, organization or individual who purchases an AED for use in a medical emergency involving an unconscious person who is not breathing. This definition does not apply to individuals who have been prescribed an AED by a physician for use on a specifically identified individual.

AED Site

A site, building or facility owned by the County of El Dorado, that has an AED installed and available to employees and/or the public.

Cardiopulmonary Resuscitation (CPR)

Basic emergency procedures for life support, consisting of artificial respiration, manual external cardiac massage, and maneuvers for relief of foreign body airway obstruction.

Internal Emergency Response Plan:

A written plan of action which utilizes responders within a facility to activate the 911 emergency systems, and which provides for the access, coordination and management of immediate medical care to seriously ill or injured individuals.

Lay Rescuer

Any person not otherwise licensed or certified to use the AED who has successfully completed a CPR/AED training program, has successfully passed the appropriate competency-based skills examinations, and maintains competency by participating in periodic reviews. The lay rescuer adheres to the procedures set forth in this program. There is to be 1 lay rescuer for every 5 AEDs.

Site Manager

Designated person within a department responsible for the administrative oversight and maintenance of the AED.

**Attachment B
Contact Telephone List**

For information and assistance regarding the County of El Dorado AED program, the individuals listed below may be contacted.

County AED Program Manager

Title	Phone No.
Risk Manager	530-621-6520

Alternate County AED Program Manager

Title	Phone No.
Senior Risk Analyst	530-621-5565

The following list contains contact information for site managers, responsible for the ordering and replenishment of supplies (i.e., batteries, pads, etc.) when needed.

Attachment C
Written Response Plan Checklist

Listed below are key elements taken from the California AED regulations and statutes. These elements are placed in this checklist format to assist in implementing the AED program within the County of El Dorado.

- Notify the County of El Dorado Emergency Services of the existence, location, and type of every AED within the County facilities.
- Identify the site manager for each facility.
- Identify and train lay rescuers.
 - Place AEDs strategically to ensure timely response.
- Ensure that basic instructions for AED use are placed with the AEDs, in no less than 14-point type.
- Ensure that signs are placed in strategic locations to notify potential responders about AED locations.
- Address internal and external emergency communications:
 - Internal Notification - Once notified of an emergency, _____ will notify the facility emergency responders.
 - "911" Notification - Once notified of an emergency, _____ will call 911 to initiate public safety agencies.
- Schedule routine inspection of AEDs, electrodes, batteries, and ancillary equipment.
- Schedule and conduct periodic response drills.
- Address post-event review and feedback, including analysis of response plan effectiveness, rescuer performance, and AED function.

**Attachment D
AED Maintenance and Inspection Log**

Site Address		
Specific Location of Unit: (i.e. 1st Floor Lobby, security desk drawer)		
On-site AED Personnel	Specific Location at Site Address	Phone No.

Maintenance Checks Inspection Log	January <small>_____</small> Date	April Biannual #1 <small>_____</small> Date	July <small>_____</small> Date	October Biannual #2 <small>_____</small> Date
Verify <i>Status</i> indicator is GREEN .				
Verify that there is no audible beeping.				
Check the expiration date of the electrode pads. If expired or appear opened, contact the Program Manager immediately.				
Close the lid and confirm <i>Status</i> indicator remains GREEN .				
Inspect the <i>Ready Kit</i> verifying no items have been removed. See <i>Ready Kit</i> list below for details.				
Remove and reinsert the battery to initiate a <i>Battery Insertion Self-Test</i> .				

Initial in the appropriate box after completing each step

Ready Kits should contain, at a minimum, the following items:

- Scissors
- Razor (it may look like a small white square)
- Paper towelette
- Breathing mask
- Disposable gloves

Expiration Date	
Pads	Battery

**Attachment E
AED Post-Incident Report**

AED Operator:		Phone Number:		Incident Date/Time:	
Assistant Name & Phone #:			Location of incident:		
Victim's Last Name:			Victim's First Name:		
Victim's Address:				Victim's Phone:	
DOB:	Age:	Victim Gender: <input type="checkbox"/> Male <input type="checkbox"/> Female		Allergies:	
Current Medications:			Pertinent Medical History:		
Was CPR Started? <input type="checkbox"/> Yes <input type="checkbox"/> No <input type="checkbox"/> Unknown			By Whom:		Time:
Estimated time from victim's collapse until CPR started:			Estimated total time of CPR until application of AED:		
Number of shocks delivered:			Length of time AED used:		
Was cardiac arrest witnessed? <input type="checkbox"/> Yes <input type="checkbox"/> No <input type="checkbox"/> Unknown			By Whom:		Time:
Cause of arrest: <input type="checkbox"/> Presumed Cardiac <input type="checkbox"/> Trauma <input type="checkbox"/> Poisoning <input type="checkbox"/> Other					
Did victim ever regain a pulse? <input type="checkbox"/> Yes <input type="checkbox"/> No		Time:		Did victim ever begin breathing? <input type="checkbox"/> Yes <input type="checkbox"/> No	
Did victim ever regain consciousness? <input type="checkbox"/> Yes <input type="checkbox"/> No		Time:		Other Treatment:	
Transporting agency:			Hospital victim taken to:		Time:
Description of incident:					
Comments:					
Witnesses:			Phone Number:		

Submitted by: _____ **Date:** _____ **Phone:** _____

*Send completed form to AED Program Coordinator, c/o Risk Management: 330 Fair Lane, Placerville, CA 95667
Via interoffice mail within 24 hours of event*

Review/Recommendations:			
Coordinator Reviewed:	Date:	Incident Number:	AED Serial Number:
Physician Reviewed:	Date:	Comments:	
Reviewed with Responders:	Date:		

TO BE COMPLETED AT A LATER DATE:

Admitted to hospital ICU: <input type="checkbox"/> Yes <input type="checkbox"/> No		Admitted to general hospital: <input type="checkbox"/> Yes <input type="checkbox"/> No	
Expired in hospital ER: <input type="checkbox"/> Yes <input type="checkbox"/> No	Discharged Alive: <input type="checkbox"/> Yes <input type="checkbox"/> No	Alive at one year: <input type="checkbox"/> Yes <input type="checkbox"/> No	



County of El Dorado, California

Regulatory Compliance Program No. 2 Aerosol Transmissible Disease Exposure Control

I. Purpose and Scope

The California Occupational Safety and Health Administration (Cal/OSHA) Aerosol Transmissible Disease Standard, Title 8, California Code of Regulations, Sections 5199 and 5199.1 (8CCR5199 and 8CCR5199.1) requires the County of El Dorado (County) to identify those job classifications where employees may have an elevated risk of contracting a disease caused by an aerosol transmissible pathogen such as tuberculosis, avian influenza, swine influenza, and any other diseases listed in Attachment A. This regulatory compliance program (RCP) provides guidance to affected County departments and employees on the procedures for controlling occupational exposure to aerosol transmissible diseases (ATD). A copy of this RCP and specific departmental procedures will be accessible to all affected employees.

An effective ATD exposure control program requires early identification and isolation of persons who have an active ATD. This ATD Exposure Control Program is designed to achieve: 1) use of administrative measures to reduce risk for exposure to persons who have an infectious ATD; 2) use of engineering controls to prevent the spread and reduce the concentration of infectious droplets by means of isolation or removal; and 3) use of personal protective equipment. Definitions of terms used in this program are included as Attachment B.

II. Responsibilities

A. Department directors:

1. Designate qualified persons to implement this program and develop department specific ATD exposure control procedures as specified in Attachments D and E;
2. Develop and implement procedures to ensure early identification of person(s) or patient(s) who have, or potentially may have, an infection ATD in accordance with Attachment F;
3. Develop written procedures to communicate with employees, other employers, and the local health officer regarding the suspected or diagnosed infections disease status of patients or suspects within 72 hours;
4. Implement and document ATD training for personnel including the elements listed this RCP;
5. Determine if exposure control procedures need to be modified based on incidents involving exposure of employees, positive TB screening tests, the development of signs/symptoms consistent with suspected TB, or infection with an ATD;
6. Coordinate with Human Resources Department - Risk Management Division (Risk Management) staff to develop and implement post-exposure medical evaluations for all employees who have had a significant exposure;
7. Manage all exposures and documentation of post-exposure follow up as confidential medical records; and
8. Retain records as outlined in the recordkeeping section of this RCP.

B. Supervisors:

1. Monitor compliance with this plan by employees who have a potential for occupational exposure. This includes ensuring that new employees are properly trained and that all employees attend annual training sessions; and
2. Ensure respiratory protection equipment is available in accessible locations, used by personnel when appropriate, and stored properly when not in use.

C. Employees:

1. Perform tasks and procedures in a manner that minimizes or eliminates employee exposure, comply with requirements of the ATD exposure control plan, and perform duties as trained; and
2. Report all exposure incidents to their supervisors and document in accordance with the County's workers' compensation process.

D. Risk Management:

1. Conducts an annual evaluation of the Countywide ATD Exposure Control RCP in coordination with managers and safety committees from affected departments;
2. Coordinates the tuberculosis testing, ATD immunization, and respirator fit testing in conjunction with affected departments;
3. Instructs the external medical provider to maintain employee ATD medical records as required by this program;
4. Compiles a yearly analysis of reported exposures and subsequent infections based on workers' compensation data; and
5. Consults with El Dorado County Public Health and physicians annually to evaluate the risk of transmission of ATDs to County personnel and determine if exposure control procedures need to be modified.

III. PROCEDURES

All affected Sheriff Department employees will be screened for tuberculosis (TB) at the time of hiring. All affected Sheriff Department employees are encouraged to participate in TB screening annually or as recommended by El Dorado County Public Health Department or the County's medical provider. The test will be paid for by the County. Employees testing positive for TB will be referred for further evaluation as recommended by the physician or other licensed health care professional. Employee declinations of TB testing will be documented (Attachment E).

These immunizations will be offered within 10 days of hire and repeated in accordance with medical recommendations. All declinations of offered immunizations vaccinations will be documented (Attachment F).

Vaccine Type	Vaccine Schedule
Seasonal Influenza	Generally one dose annually
Measles	Two doses
Mumps	Two doses
Rubella	One dose
Tetanus, Diphtheria, and Acellular Pertussis (Tdap)	One dose, booster as recommended
Varicella-zoster (VZV)	Two doses

Following any significant exposure to an ATD, employees will be sent for a medical evaluation, testing, and any follow up tests or treatment recommended by the El Dorado County Public Health Department or the County’s medical provider. The County’s medical provider will be consulted to determine if precautionary removal from normal duty is required.

IV. Training

All affected employees will receive ATD training relevant to their position. The need for additional training beyond initial assignment of tasks where occupational exposure may take place will be re-evaluated annually and re-training will take place at least annually. Annual refresher training may be limited to provisions of the standard not previously covered as well as new tasks, work practices, and exposure control measures. All training must include an opportunity for employees to ask questions which can be answered within 24 hours by a knowledgeable person. Initial training must include the following information:

- A. Location of the Cal/OSHA ATD regulation (8CCR5199);
- B. A general explanation of ATDs, including signs and symptoms of ATDs that require further medical attention;
- C. An explanation of the modes of transmission of aerosol transmissible pathogens (ATPs) and applicable source control procedures;
- D. An explanation of the department’s exposure control procedures, the means by which the employee can obtain a copy of the written exposure control plan, and how they can provide input as to its effectiveness;
- E. Appropriate methods for recognizing tasks and other activities that may expose employees to ATPs;
- F. Use and limitations of methods to prevent or reduce exposure to ATPs, including engineering and work practice controls, decontamination and disinfection procedures, and personal and respiratory protective equipment;
- G. The basis for selection of personal protective equipment, location, proper use and

limitations, cleaning, decontamination, and disposal of contaminated equipment;

- H. A description of the department's TB surveillance procedures, including the information that persons who are immune-compromised may have a false negative test for latent TB;
- I. Training and fit testing meeting the requirement of Cal/OSHA's Respiratory Protection Program (8CCr5144) for employees whose assignment includes the use of a respirator;
- J. Information on immunizations offered by the County;
- K. An explanation of post exposure procedures including reporting the incident, medical follow-up, and post-exposure evaluation;
- L. Information on the department's surge plan as it pertains to the duties that employees will perform. As applicable, this training shall cover the plan for surge receiving and treatment of patients, patient isolation procedures, how to access supplies needed for the response including personal protective equipment and respirators, decontamination facilities and procedures, and how to coordinate with other emergency response personnel and outside agencies; and
- M. Information on the proper procedures for the disposal of animal waste.

Recordkeeping and Plan Review

A. Training Records

Training records must be maintained by the department for a minimum of three years and must include the following:

1. The dates of training;
2. The contents or a summary of training;
3. The names and qualifications of persons conducting the training; and
4. The names, job titles, and signatures of all persons attending the training.

B. Medical Records

Medical records must be maintained for at least the duration of employment plus 30 years. They are to be kept confidential unless there is written consent from the employee to disclose information. These records must comply with 8CCR3203 and 8CCR3204 and must include the following:

1. The name and social security number of the employee;
2. The employee's vaccination status, including a copy of the employee declination forms; and
3. Results from ATD medical examinations, testing, and follow-up procedure including any written opinions provided by a healthcare professional and any information provided to the healthcare professional.

C. Plan Implementation and Review

Record of annual reviews of the ATD plan must include names of the persons conducting the

reviews, dates of the reviews, names, and work areas of employees involved and a summary of the conclusions. These records must be kept for at least three years. The ATD Exposure Control Program and any department specific procedures will be reviewed at least annually or when any of the following conditions exist:

1. New or modified tasks and procedures effect occupational exposure are developed;
2. Changes in technology that reduce or eliminate exposure to ATPs become available;
3. New or revised employee positions with occupational exposures are identified;
4. Evaluation of exposure incidents indicate changes are needed; or
5. The ATD Prevention Program is deficient in any area.

D. Exposure Incidents

Workers' Compensation will retain records of exposure incidents to be made available as employee exposure records in accordance with 8CCR3204. Exposure records will include the date of the incident; the names of the employees involved; the potential disease or pathogen; the name and job title of the person performing the evaluation; the identity of any local health officer, physician, or licensed health care professional consulted; the date of the evaluation; and the date of contact. Departments will maintain contact information for any other employers notified regarding potential employee exposure.

Attachment A
Aerosol Transmissible Disease/Pathogens (Appendix A from 8CCR5199)

Aerosol Transmissible Diseases/Pathogens (Mandatory)

This appendix contains a list of diseases and pathogens which are to be considered aerosol transmissible pathogens or diseases for the purpose of Section 5199. Employers are required to provide the protections required by Section 5199 according to whether the disease or pathogen requires airborne infection isolation or droplet precautions as indicated by the two lists below.

Diseases/Pathogens Requiring Airborne Infection Isolation

Aerosolizable pore-containing powder or other substance that is capable of causing serious human disease, e.g.

Anthrax/Bacillus anthracis

Avian influenza/Avian influenza A viruses (strains capable of causing serious disease in humans).

Bordetellosis (Bordetella bronchiseptica) - Feline zoonotic

Varicella disease (chickenpox, shingles) Varicella zoster and Herpes zoster viruses, disseminated disease in any patient. Localized disease in immunocompromised patient until disseminated infection ruled out

Measles (rubella)/Measles virus

Monkeypox | Monkeypox virus

Novel or unknown pathogens

Psittacosis-Avian zoonotic

Severe acute respiratory syndrome (SARS)

Smallpox (variola) Variolola virus

Tularemia-Rabbit, hare and rodent zoonotic

Tuberculosis (TB)/Mycobacterium tuberculosis-- Extra pulmonary, draining lesion; Pulmonary or laryngeal disease, confirmed; Pulmonary or laryngeal disease, suspected

Any other disease for which public health guidelines recommend airborne infection isolation

Diseases/Pathogens Requiring Droplet Precautions

Diphtheria pharyngeal

E. coli infections

Epiglottitis, due to Hemophilus influenza type b

Hemophilus influenza Serotype b (Hob) disease/Hemophilus influenza serotype b -- Infants and children

Influenza, human (typical seasonal variations) influenza viruses

Meningitis

Homophiles influenza, type b known or suspected

Nisei meningitides (meningococcal) known or suspected

Meningococcal disease sepsis, pneumonia (see also meningitis)

Mumps (infectious parotitis)/Mumps virus

Mycoplasmal pneumonia

Parvovirus B19 infection (erythema infectiosum) Pertussis (whooping cough)

Pharyngitis in infants and young children/Adenovirus, Orthomyxoviridae, Epstein-Barr virus, Herpes simplex virus,

 Pneumonia

 Adenovirus

 Homophiles influenza Serotype b, infants and children

 Meningococcal

 Mycoplasma, primary atypical Streptococcus Group A

Pneumonic plague/Yersinia pestis

Rubella virus infection (German measles)/Rubella virus

Rabies-mammal zoonotic

Severe acute respiratory syndrome (SARS)

Streptococcal disease (group A streptococcus)

Skin, wound or burn, Major

 Pharyngitis in infants and young children

 Pneumonia

 Scarlet fever in infants and young children

 Serious invasive disease

Viral hemorrhagic fevers due to Lassa, Ebola, Marburg, and Crimean-Congo fever viruses (airborne infection isolation and respirator use may be required for aerosol-generating procedures)

Any other disease for which public health guidelines recommend droplet precautions

Attachment B Definitions

Aerosol

A suspension of liquid or solid particles in air, including droplets, droplet nuclei, fomites and dust.

Aerosol transmissible disease (ATD) or aerosol transmissible pathogen (ATP)

A disease or pathogen for which droplet or airborne precautions are required as per 8CCR5199 or 8CCR5199.1, as listed in Attachment A; a pathogen that is transmitted by liquid or solid particles in the air including droplets, droplet nuclei, fomites and dusts.

Animal Waste

Animal carcasses, excrement, contaminated litter or debris from the bodies of animals such as feathers or dander.

CDC

United States Centers for Disease Control and Prevention.

Contaminated

A term used to describe the presence or the reasonably anticipated presence of a known pathogen or other potentially infectious material that has soiled, stained, or corrupted by coming in contact with a surface or item.

Decontamination

The use of physical or chemical means to remove, inactivate or destroy pathogenic substances on a surface or item to the point where they are no longer capable of transmitting infection and the surface or item is deemed safe for handling, use, or disposal.

Droplet Precautions

Infection control procedures as described in Guidelines for Isolation Precautions which are designed to reduce the risk of transmission of infectious agents through contact of the conjunctivae or the mucous membranes of the nose or mouth of a susceptible person with large- particle droplets (larger than 5 m in size) containing microorganisms generated from a person who has a clinical disease or who is a carrier of the microorganism.

Engineering Controls

Controls that isolate, remove, or create a barrier from pathogenic hazards from the workplace or operation (e.g., such as negative pressure ventilation systems).

Exposure Incident, Airborne

An event in which all of the following have occurred: (1) an employee has been exposed to an individual who is a case or suspected case of a reportable ATD, or to a work area or to equipment that is reasonably expected to contain ATPs associated with a reportable ATD; and

(2) (3) it reasonably appears from the circumstances of the exposure that transmission of disease is sufficiently likely to require medical evaluation.

Occupational Exposure

Exposure from work activity or working conditions that is reasonable anticipated creating an elevated risk of contracting any disease caused by ATPs if protective measures are not in place. In this context, "elevated" means higher than what is considered ordinary for employees having direct contact with the general public outside of the facilities, service categories and operations listed in 8CCR5199 and 8CCR5199.1.

Personal Protective Equipment (PPE)

Specialized clothing or equipment worn or used for protection against a hazard (e.g., gloves, masks, goggles, face shields, etc.). This does not include general work clothes (e.g., uniforms, pants, shirts).

Physician or other licensed health care professional (PLHCP)

Means an individual whose legally permitted scope or practices (e.g., license, registration, or certification) allows him or her to independently provide, or be delegated the responsibility to provide, some or all of the health care services required by 8CCR5199 and 8CCR5199.1.

Referring Employer

Any employer that operates a facility, service, or operation in which there is occupational exposure and which refers airborne infectious disease cases and suspected cases to other facilities; the services and operations of referring facilities do not include providing diagnoses, treatment transports, housing, isolation or management to persons; Law enforcement, corrections, public health, and other operations that provide only non-medical transport for referred cases are considered referring employers if they do not provide diagnosis treatment, housing, isolation or management of referred cases.

Significant Exposure

An exposure to a source of ATPs in which the circumstances of the exposure make the transmission of a disease sufficiently likely that the employee requires further evaluation by a PLHCP; this can mean prolonged exposure within six feet of a source without use of source control measures.

Standard Precautions

A concept used in hospitals to assist in reducing the spread of multi-drug resistant organisms which treats all bodily secretions except sweat as potentially infectious materials. Standard precautions are the practice of assuming that anything that could be potentially infectious is infectious.

Source Control Measures

The use of administrative procedures, engineering controls, personal protective equipment and/or other devices or materials to minimize the spread of airborne particles and droplets from an individual who has or exhibits signs or symptoms of having an ATD, such as persistent coughing.

Surge

A rapid expansion beyond normal services to meet the increased demand for qualified personnel, medical care, equipment, and public health services in the event of an epidemic, public health emergency, or disaster.

Suspected Case

Either of the following: 1) a person whom a health care provider believes, after weighing signs, symptoms, and/or laboratory evidence, to probably have a particular disease or condition listed in Attachment A, or 2) a person who is considered a probable case, or an epidemiologically-linked case, or who has supportive laboratory findings under the most recent communicable disease surveillance case definition established by Centers for Disease Control and published in the Morbidity and Mortality Weekly Report (MMWR) or its supplements as applied to a particular disease or condition listed in Attachment A.

Wildlife

Wild birds and other animals that are not domesticated, includes their remains and waste.

Zoonotic Aerosol Transmissible Disease (Zoonotic ATP)

A disease agent that is transmissible from animals to humans by aerosol and is capable of causing human disease.

Attachment C
Components of ATD Written Procedures for Non-Animal Related Exposures

Written procedures used by departments with non-animal related exposures to ATDs will include the following:

1. A list of any high hazard procedures and the job classifications and operations in which employees are exposed to those procedures.
2. Tasks requiring the use of personal protective equipment. Respiratory protection must be at least as effective as N-95. P-100 must be used for high hazard emergency medical services.
3. A description of infection control measures for source patients or suspects, and the method of informing people entering the work setting of the source control measures.
4. Procedures for employees and supervisors to follow in the event of an exposure incident, including how the department will determine which employees had a significant exposure.
5. Procedures the department will use to evaluate exposure incidents, determine the cause, and revise existing procedures to prevent future incidents.
6. Procedures the department will use to ensure that there is an adequate supply of personal protective equipment and other equipment necessary to minimize employee exposure to aerosol transmissible pathogens in normal operations and foreseeable emergencies.
7. Procedures the department will use during surge conditions such as an epidemic, public health emergency or disaster. This may include procedures for providing services to persons who have been contaminated as the result of a release of a biological agent. The surge plan should include: information on work practices; decontamination facilities; procedures for stockpiling, accessing, and procuring respiratory and personal protective equipment; and how the department will interact with the local and regional emergency plans.
8. Procedures for cleaning work areas, vehicles, and equipment.

Attachment D
Screening Criteria for Referrals of Patients/Suspects to Health Care Providers

Referrals to health care providers will be provided to persons who do any of the following:

1. Have a cough for more than three weeks that is not explained by non-infectious conditions.
2. Exhibit signs and symptoms of a flu-like illness during March through October, the months outside of the typical period for seasonal influenza, or exhibit these signs and symptoms for a period longer than two weeks at any time during the year. These signs and symptoms generally include combinations of the following: coughing and other respiratory symptoms, fever, sweating, chills, muscle aches, weakness, and malaise.
3. State that they have a transmissible respiratory disease, excluding the common cold and seasonal influenza.
4. State that they have been exposed to an infectious ATD case, other than seasonal influenza.

Note: per 8CCR5199, seasonal influenza does not require referral.

Attachment E
Tuberculosis Screening Test Informed Declination Form

I understand that I may be occupationally exposed to tuberculosis (TB) and that I may be at risk of acquiring TB. I understand that the Centers for Disease Control and the California Occupational Safety and Health Administration recommended that I should be tested to determine whether I have contracted TB.

I have been given the opportunity to be tested for TB at no charge to myself. However, I decline TB testing at this time. I understand that by declining this screening, I am at risk of having TB without my knowledge. I understand that I will be able to obtain testing for TB in the future if I choose to change my mind.

I have had the opportunity to ask questions and they have been answered to my satisfaction.

Printed Employee Name: _____

Employee Signature: _____ Date: _____

Attachment F
Aerosol Transmissible Disease Vaccination Acceptance/Declination Statement

I understand that due to my occupational exposure to aerosol transmissible diseases, I may be at risk of acquiring infection with: mumps, measles, rubella (MMR); tetanus, diphtheria, and acellular pertussis (TDAP); varicella; and influenza.

I have been given the opportunity to be vaccinated against these diseases or pathogens at no charge to me.

	Accept	Decline
Mumps, measles and rubella (MMR)	_____	_____
Tetanus, diphtheria and acellular pertussis (TDAP)	_____	_____
Varicella	_____	_____
Influenza	_____	_____

I have indicated my acceptance or declination of each vaccination at this time by signing my initials on the lines provided.

I understand that by declining vaccination, I continue to be at risk of acquiring mumps, measles, rubella, tetanus, diphtheria, or acellular pertussis which are serious diseases. If in the future I continue to have occupational exposure to aerosol transmissible diseases and want to be vaccinated, I can receive the vaccination at no charge to me.

Employee's Printed Name: _____

Employee's Signature: _____ Date: _____



County of El Dorado, California

Regulatory Compliance Program No. 3 Bloodborne Pathogen Control

I. Purpose

This written regulatory compliance program (RCP) provides procedures to reduce the likelihood of exposure to and/or transmission of infectious bloodborne pathogens during the performance of duties by County of El Dorado (County) employees. This RCP complies with the California Code of Regulations (CCR), Title 8, Section 5193, Bloodborne Pathogens. Bloodborne pathogens include, but are not limited to, Hepatitis B (HBV), Hepatitis C (HCV), and Human Immunodeficiency Virus (HIV).

Departments may develop, implement, and maintain additional written procedures and guidelines (e.g., Standard Operating Procedures, General Orders, Manual of Operations) to eliminate or minimize employee exposure to bloodborne pathogens and other infectious diseases as needed. A copy of these procedures and this exposure control plan must be accessible to employees who may have occupational exposures. Employees are required to follow these procedures to control potential occupational exposures to infectious diseases by utilizing universal precautions (i.e., body substance isolation procedures) to reduce exposure to potentially infectious materials. Work practice controls must be in writing and comply with the minimum requirements of CCR 8 Section 5193 (d).

II. Exposure Determination

- A. Specific employee classifications which may be exposed to blood or other potentially infectious materials (OPIMs) are listed in the definitions. These include the following employees:
1. All County employees who are expected to be exposed to blood or OPIMs during performance of their duties.
 2. Employees whose primary assignment includes rendering of first aid on a regular basis (e.g., sheriff).
 3. Employees who in the course of their duties of cleaning public areas may come in contact with OPIMs.
- B. Employees must follow the procedures listed in the following table for any occupational exposures:

Incident Level	Incident Description	Action to Be Taken
1.	Close proximity to potentially infectious materials or person(s).	Complete first report of Injury Form (WC001) and check exposure box
2.	Contamination of clothing, equipment, and/or unprotected skin contact.	Wash body parts, equipment, and/or clothing thoroughly. Complete first report of injury form (WC001) and check exposure box
3.	True exposure involving contact with a person's bodily fluids through non-intact skin, needle stick, or mucous membranes.	Seek medical attention immediately. Complete first report of injury form (WC001) and DWCI. Notify designated Medical Officer or Risk

III. Exposure Control and Post-Exposure Procedures

The following exposure control practices are the minimum requirements for this bloodborne pathogen exposure control plan. Employees also need to comply with any department-specific policies and procedures.

A. Hygienic Work Practices

1. Hand-washing facilities are generally readily available to employees.
2. If hand-washing facilities are not feasible, antiseptic hand cleaner will be provided and hands must be washed with soap and warm water as soon as possible after exposure.
3. Hands must be cleaned as soon as possible after removal of gloves or other personal protective equipment (PPE).
4. Hands and any other skin must be washed with soap and water as soon as possible following contact with blood or OPIM. Mucous membranes must be flushed with water.

B. Hepatitis B Vaccination (pre-exposure)

1. The Hepatitis B vaccine series is available to all employees who may have occupational exposure to bloodborne pathogens. The series is available to all affected employees at no cost after they have received the required training. This should occur within 10 working days of initial assignment.
2. If an employee declines the Hepatitis B vaccine, they must complete and sign the declination form provided by the department.
3. Employees who sign the statement of declination may revoke the declination at any time by contacting Risk Management and agreeing to accept the Hepatitis B vaccination.

C. Personal Protective Equipment

1. PPEs such as, but not limited to, gloves, gowns, face shields, masks, eye protection, and mouthpieces or pocket masks will be made available to employees.
2. Appropriate PPEs must be used when there is likelihood of occupational exposure.
3. PPEs will be made available in appropriate sizes.
4. Disposable (single use) gloves must be worn when it can reasonably be anticipated that an employee may have hand contact with blood or OPIM when performing CPR and/or first aid. Gloves shall be replaced as soon as possible once contaminated, torn, or punctured. Hypoallergenic gloves or similar alternatives must be made available to those employees who are sensitive to the gloves normally provided. Disposable gloves must not be washed or decontaminated for re-use.
5. Masks and eye protection must be worn whenever splashes, sprays, splatters, or droplets of infectious materials may be generated and eye, nose, or mouth contamination can be reasonably anticipated.

D. Housekeeping

1. Any area that may come in contact with OPIM must be maintained in a clean and sanitary condition. All counter tops, work surfaces, and floors must be disinfected at least daily by using an Environmental Protection Agency (EPA) approved disinfectant or a 1:10 bleach to water solution that is mixed fresh and not more than 24 hours old.
2. Protective coverings on equipment must be removed and replaced as soon as possible when they become obviously contaminated.
3. All pails, bins, and cans intended for re-use which have a likelihood of becoming contaminated with blood or OPIM must be lined with red biohazard bags and properly disposed of.
4. Broken glassware, which may be contaminated, must be picked up by a mechanical method (not by hand) (e.g., using pliers, tweezers, tongs) and disposed of in designated hard-walled waste containers.

E. Contaminated Sharps

1. All contaminated sharps must be disposed of immediately in red labeled or color-coded "sharps" containers displaying the biohazard symbol. These containers are portable, closeable, sealable, leak resistant and, once sealed, are incapable of being re-opened without great difficulty.
2. All sharps containers must be easily accessible to work area, kept closed unless adding sharps, kept upright, replaced routinely, and not allowed to be filled to level greater than 2/3 total capacity.
3. Disposal of regulated waste will be in compliance with state and local regulations.

F. Laundry

1. Contaminated laundry must be handled as little as possible and only with proper PPEs (e.g., gloves).

2. Contaminated laundry must be placed in color-coded (i.e., red biohazard) bags that prevent soak through or leakage of fluids to the exterior.
3. Disposal of regulated waste will be in compliance with state and local regulations.

G. Post-Exposure Evaluation and Follow-Up

1. Following a report of an exposure incident, a confidential medical evaluation and follow-up must be made immediately available to the exposed employee with the County's medical services provider. Post-exposure evaluation and follow-up for bloodborne pathogens exposure is also available to all employees who have had exposure incidents.
2. The supervisor will document the route(s) of exposure and the circumstances under which the exposure incident occurred by completing the First Report of Injury form (WC001). The supervisor must also notify the department's designated officer or Risk Management.
3. The supervisor must identify and document the source individual, unless it is established that identification is infeasible or prohibited by state or local law. If possible, in accordance with state law, the source individual's blood will be tested and the results documented and made available to the exposed employee. The employee will also be informed of the laws related to disclosure.
4. Post-exposure treatment will be provided if medically indicated. The full hepatitis B vaccination series will be made available within 24 hours to all unvaccinated first aid providers who have rendered assistance in any situation involving the presence of blood or OPIM regardless of whether or not a specific exposure incident has occurred. The employee will receive health care professional's written opinion within 15 days.
5. Counseling and medical follow-up for reported illnesses will be provided.

IV. Hazard Communication and Training

A. Signs and Labels

Biohazard labels must include the word "biohazard." Labels must be fluorescent orange or orange-red in color with contrasting black lettering. Labels must be attached to containers of regulated medical waste or other OPIM. Red bags or red containers may be substituted for labels except for sharp containers or regulated waste red bags.

B. Training

Annual training is required for employees who have occupational exposure to bloodborne pathogens and infectious diseases. All training must be documented. As required by the Bloodborne Pathogen Standard, training must at least include the following elements:

1. A copy and explanation of the Bloodborne Pathogen Standard;
2. The County's Bloodborne Pathogen Exposure Control Plan;
3. Department specific procedures;
4. Epidemiology and symptoms;
5. Modes of transmission;
6. Risk identification;

7. Methods of compliance;
8. Decontamination and disposal procedures;
9. Use and care of PPEs;
10. Hepatitis B vaccination series;
11. Emergency actions;
12. Exposure Incidents;
13. Post-exposure procedures;
14. Signs and labels; and
15. Be interactive with questions and answers.

V. Recordkeeping and Plan Review

A. Training Records

Training records must be maintained by the department for a minimum of three years. Training records must include the following:

1. The dates of the training;
2. The contents or a summary of training;
3. The names and qualifications of persons conducting the training; and
4. The names, job titles, and signatures of all persons attending the training.

B. Medical Records

Medical records must be maintained for at least the duration of employment plus 30 years. They are to be kept confidential unless there is written consent from the employee to disclose information. These records must include the following:

1. The name and social security number of the employee;
2. A copy of the employee's Hepatitis B vaccination status, including a copy of the employee's declination form or the dates of the Hepatitis B vaccinations; and
3. A copy of all results from examinations, medical testing, and follow-up procedures and including any written opinions provided to employer by a healthcare professional and/or a copy of the information provided to the healthcare professional.

C. Sharps Injury Log

A sharps injury log must be maintained by Workers' Compensation for a minimum of five years from the date the exposure incident occurred. Each exposure incident must be recorded within 14 working days of the date of the incident. The log must be maintained in such a manner as to protect the confidentiality of the injured employee. The log must include the following information, if known or reasonably available:

1. Date and time of exposure incident;
2. Type of brand of sharp involved in the exposure incident;

3. A description of the exposure incident, which must include the job classification of the exposed employee, the department or work area where the exposure incident occurred, the procedure that the exposed employee was performing at the time of the incident, how the incident occurred, and the body part involved in the exposure incident;
4. If the sharp had engineered sharps injury protection or not, whether the protection was activated, and if the injury occurred before, during, or after the activation of the mechanism; and
5. The injured employee's opinion as to whether and how such an engineered protection mechanism could have prevented the injury as well as if any engineering, administrative, or work practice control could have prevented the exposure or injury.

D. Plan Review

This Bloodborne Pathogen Exposure Control Plan and any department-specific procedures will be reviewed at least annually or when any of the following conditions exist:

1. When new or modified tasks and procedures which effect occupational exposure are developed;
2. When changes in technology that reduce or eliminate exposure to bloodborne pathogens become available;
3. When new or revised employee positions with occupational exposures are identified;
4. When the review and evaluation of exposure incidents indicate changes are needed; or
5. When information indicating the Bloodborne Pathogens Exposure Control Plan is deficient in any area are identified.

Attachment A Definitions

Blood

Human blood, human blood components, and products made from human blood.

Bloodborne Pathogens

Pathogenic microorganisms that are present in human blood and can cause disease in humans. These pathogens include, but are not limited to Hepatitis B virus (HBV) Hepatitis C virus (HCV) and Human Immunodeficiency Virus (HIV).

Contaminated

The presence or the reasonably anticipated presence of blood or other potentially infectious materials on a surface or an item.

Decontamination

The use of physical or chemical means to remove, inactivate or destroy bloodborne pathogens on a surface or item to the point where they are no longer capable of transmitting infectious particles and the surface or item is rendered safe for handling, use, or disposal.

Engineering Controls

Controls that isolate or remove the bloodborne pathogens hazard from the workplace (e.g., sharps disposal containers, needleless systems and sharps with engineered sharps injury protection).

Engineered Sharps Injury Protection

A physical attribute built into a needle device used for withdrawing body fluids, accessing a vein or artery, or administering medications or other fluids which effectively reduces the risk of an exposure incident by a mechanism such as barrier creation, blunting, encapsulation, withdrawal or other effective means; or a physical attribute built into any other type of needle device, or into a non-needle sharp which effectively reduces the risk of an exposure incident.

Exposure Incident

A specific eye, mouth, other mucous membrane, non-intact skin, or parenteral contact with blood or other potentially infectious materials that results from the performance of an employee's duties.

Occupational Exposure

Reasonably anticipated skin, eye, mucous membrane, or potential contact with blood or other potentially infectious materials that may result from the performance of an employee's duties.

OPIM

Other potentially infectious materials including these human body fluids: semen, vaginal secretions, cerebrospinal fluid, synovial fluid, pleural fluid, pericardial fluid, peritoneal fluid, amniotic fluid, any other body fluid that is visibly contaminated with blood such as saliva or vomitus, and all body fluids in situations where it is difficult or impossible to differentiate between body fluids, such as emergency response.

Parenteral Contact

Piercing mucous membranes or the skin barrier through such events as needle sticks, human bites, cuts, and abrasions.

Personal Protective Equipment (PPE)

Specialized clothing or equipment worn or used for protection against a hazard (e.g., gloves, masks, goggles, face shields, etc.). This does not include general work clothes (e.g., uniforms, pants, shirts).

Regulated Waste

Waste that is liquid or semi-liquid blood or OPIM; contaminated items that contain liquid, semi-liquid or dried-blood which are capable of releasing these materials when handled or compressed; contaminated sharps, pathological or microbiological wastes containing blood or OPIMs, or medical waste regulated by Health and Safety Code Sections 117600 through 118360.

Sharps

Any object used or encountered that can be reasonably anticipated to penetrate the skin or any other part of the body, and to result in an exposure incident, including, but not limited to, needle devices, broken glass and exposed ends of dental wires.

Universal Precautions

An approach to infection control where all human blood and certain human body fluids are treated as if known to be infectious for HIV, HBV, HCV, and other bloodborne pathogens.



County of El Dorado, California

Regulatory Compliance Program No. 4 Bomb Threats and Suspicious Packages

I. Purpose and Scope

This regulatory compliance program (RCP) policy establishes uniform procedures for responding to bomb threats and suspicious packages. Malicious conveyance of false information which concerns an attempt to kill, injure, or intimidate any individual or to unlawfully destroy any building, vehicle, or personal property is a criminal offense. Examples include bomb threats, threats of a nuclear or dirty bomb, and threats of anthrax or other communicable diseases.

Chemical agents are poisonous vapors, aerosols, liquids, or solids that have toxic effects on people, animals, or plants. They can be released by bombs, sprayed, or used as a liquid to create a hazard to people and the environment. They can have an immediate effect (a few seconds to a few minutes) or a delayed effect (several hours to several days). While potentially lethal, chemical agents are difficult to deliver in lethal concentrations. Outdoors, the agents often dissipate rapidly. Chemical agents are also difficult to produce.

Biological agents are organisms or toxins that can kill or incapacitate people, livestock, and crops. The three basic groups of biological agents that would likely be used as weapons are bacteria, viruses, and toxins. Most are difficult to grow and maintain. Many break down quickly when exposed to sunlight and other environmental factors, while others, such as anthrax spores, are very long-lived.

In addition to law enforcement agencies, the Federal Bureau of Investigation (FBI) and other federal agencies may also investigate serious incidents.

In response to a credible threat involving a bomb or suspicious package, law enforcement and fire departments initiate a threat assessment process that involves close coordination with other agencies and the surrounding community agencies with technical expertise.

II. Responsibilities

A. The Human Resources Department - Risk Management Division (Risk Management) will:

1. Ensure a current Bomb Threat Checklist (Attachment A) is maintained on the Risk Management Intranet page of EDCNET;
2. Review this policy annually for updates and changes;
3. Provide leadership and direction in crisis management response to department safety coordinators (DSC), who in turn will provide this information through regular safety meetings with their respective department; and
4. Convene ongoing meetings with DSCs regarding crisis management responses. These meetings are held to formulate incident action plans, define priorities, review status, resolve conflicts, identify issues that require decisions from higher authorities, and evaluate the need for additional resources.

B. Department heads or their designees will:

1. Ensure that all personnel are instructed on the Bomb Threat Checklist, including how to find it on EDCNET, the form's use, and the requirement for accurate completion and timely submission of the forms to the leadership of the organization;

2. Ensure that employees, security, and custodial personnel are instructed to be alert for suspicious looking persons or foreign suspicious objects or parcels in the organization and to immediately report suspicious circumstances up the chain of command and to Risk Management. Make periodic checks of potential concealment areas for such objects;
3. Ensure Standard Operating Procedures (SOPs) are developed by each organization and included in the Injury and Illness Prevention Policy/Emergency Action Plan, with a copy provided to Risk Management. Provide appropriate training for all personnel concerning the handling of bomb threats and suspicious packages. In preparing the SOPs, reference this policy and request assistance from the Sheriff's Department Office of Emergency Services (OES) and Risk Management;
4. Establish and post evacuation routes and an alarm to notify all personnel of the evacuation. Ensure that a roster is prepared of all personnel departing the building in the event that medical notification is required (i.e., the discovery of anthrax spores will warrant immediate medical attention by personnel in contact with the source). Establish a rendezvous/meeting/gathering area at least 330 feet from the affected building and, wherever possible, upwind of the building;
5. Maintain stringent control of locks and keys. Lock doors to boiler rooms, basements, and utility closets when not in use thereby eliminating places to hide devices that would cause a serious incident. Evacuation and Search Team members may still need access to these rooms so ensure the keys are available;
6. Order an evacuation, as required, based upon a threat assessment and/or the finding of any suspicious object or package;
7. Ensure occupants familiar with the area/building report suspicious objects in and around their respective working areas;
8. Be prepared to establish an onsite Evacuation Team and Command Post. The senior agency representative on site will command the team and will turn control of on-site incident operations over to the police upon their arrival;
9. Ensure subordinate divisions have SOPs and policies in place for appropriate responses;
10. Ensure that all personnel are properly trained and equipped to respond to bomb threats and suspicious package incidents and that subordinate divisions have internal SOPs and policies in place for appropriate responses;
11. Ensure SOPs and policies are in place to turn off power/heating, ventilation, and air conditioning (HVAC) systems, if required; and
12. Provide building blueprints and utilities schematics.

III. Training Requirements

Training is available from OES and may be scheduled on an as-needed basis.

IV. Procedures

Response to Bomb Threats

A. When an individual receives a threat call, that individual will:

1. Record the entire dialog of the conversation on the Bomb Threat Checklist (Attachment A).
2. Keep the caller on the line as long as possible by listening and not interrupting. Ask the person to speak louder or to repeat the message to keep them on the line. If the caller does not address something on the Bomb Threat Checklist, then ask the location of the bomb, time of detonation, etc. Gather as much information as the caller will provide.
3. Pay particular attention to peculiar background noises, such as motors, including aircraft, music, or any other noises which may give clues to the caller's location.
4. Listen carefully to the voice of the caller to determine distinguishing characteristics (i.e., male or female, voice quality [calm, excited], accents, speech impediments, and any other characteristics indicated on the Bomb Threat Checklist).
5. If you have worked it out ahead of time during your training in response to bomb threats, signal another employee to listen in on the call. The second person can concentrate on the characteristics of the caller and the background noises. The receiver of the call concentrates on the exact words of the caller.
6. If the caller does not hang up, then leave the line open, **DO NOT HANG UP! DO NOT MAKE ANY CALLS ON THAT PHONE.** Use a **DIFFERENT PHONE** and call local police or 911 if no one else has already done so.
7. The receiver of the bomb threat should immediately notify his/her supervisor, being careful not to cause panic among fellow employees.
8. After evacuating the building remain accessible for an interview with a police investigator.

B. When notified of a bomb threat, department heads or their designees will:

1. Ensure local police have been notified of the bomb threat.
2. Direct the evacuation of the area. With technological advances and potential lethality of today's explosive devices, it is better to evacuate first and then consider further courses of action.
3. Immediately conduct an assessment of the threat received based upon information obtained from the caller on the Bomb Threat Checklist. This assessment includes a description of the device, time and location of detonation or contamination, and the caller's knowledge of the device.
4. Be prepared to establish evacuation and search teams.
5. In evacuating the building, do not stand in front of windows, glass doors, or other potentially hazardous areas. Do not block sidewalks or streets to be used by emergency officials or others exiting the building. Move at least 330 feet from the building. Any other buildings within 330 feet of the affected bomb threat building

must also be evacuated. (A 330-foot stand-off distance is generally good for explosive devices found in buildings with an explosives capacity equivalent to that of less than 50 pounds of TNT. Stand-off distances increase if the explosive devices are found outside and when the explosives capacity increases, especially if a chemical or nuclear device is found. See Attachment E for Bomb Threat Stand-Off Distances.)

6. Provide the Bomb Threat Checklist to local police investigators onscene.
- C. When determination has been made to evacuate a building, department heads or their designees will:
1. Ensure safety coordinators are trained to sweep rooms and/or offices as they exit to ensure all personnel are evacuated. This search consists of a visual check in and around all furniture and fixtures and concentrates on locating personnel not already evacuated.
 2. Under no circumstances will any untrained personnel attempt to displace, dismantle, or otherwise tamper with any suspect device or suspicious objects found.
 3. Personnel are not authorized to return to an evacuated building or facility until cleared by law enforcement or the department director.
- D. When an evacuation and/or dispersal of personnel is directed, personnel will disperse in an orderly manner. Ensure that all personnel are accounted for by name and that all personnel walk to the designated assembly area. TURN OFF ALL CELLULAR/DIGITAL PHONES. Do not use these devices within 330 feet of the affected area. Do not start any vehicles in the vicinity of the building until the threat has been terminated. Be sure to search the area around your assembly area for bombs and suspicious objects as well. It is not uncommon to have a bomb placed in an area where evacuees are expected to assemble.
- E. In the event of an explosion:
1. Leave the building as quickly as possible. Do not stop to retrieve personal possessions or make phone calls. If things are falling around you, get under a sturdy table or desk until they stop falling. Then leave quickly, watching for weakened floors and stairs and falling debris as you exit.
 2. If you are trapped in debris, do not light a match. Do not move or kick up dust. Cover your mouth with a handkerchief or clothing. Rhythmically tap on a pipe or wall so that rescuers can hear where you are. Use a whistle if one is available.

General Handling of Mail and Packages

Be wary of suspicious packages and letters. They can contain explosives, or chemical or biological agents. Some typical characteristics postal inspectors have detected over the years, which should trigger suspicion, include parcels that:

1. Are unexpected or from someone unfamiliar to you;
2. Are marked with restrictive endorsements, such as "Personal," "Confidential," or "Do Not X-ray";
3. Have protruding wires or aluminum foil, strange odors, or stains;
4. Show a city or state in the postmark that doesn't match the return address;

5. Are of unusual weight given their size, or are lopsided or oddly shaped;
6. Have inappropriate or unusual labeling; and
7. Have excessive postage or excessive packaging material such as tape and string.

Exercise the below general cautions when handling mail and packages:

1. Examine unopened envelopes/packages and look for suspicious features;
2. Handle incoming mail in a designated, separate mail area;
3. Wash your hands after mail is opened;
4. Restrict mailroom access to authorized persons; and
5. Refrain from eating or drinking in a designated mail handling area.

Response to Suspicious Packages

The individual coming in contact with a suspicious package should take the following steps:

1. If a package is leaking powder or any substance, put the package down gently in a closet or the safest place available without transporting the package out of the area already affected. Cover the substance and/or suspected package with a trash can or other material to prevent the substance from becoming airborne. Call 911 and report the suspicious package with potential hazardous material. Caller will provide the 911 operator with information as to why the package is suspicious (e.g., leaking powder, heavy stains, etc.). The individual should contact their supervisor immediately and follow the steps outlined on the Suspicious Packages Procedures Checklist in Attachment C.
2. If the suspicious package is not leaking any powder and/or substance, call 911 and report the suspicious package. Be prepared to describe to the 911 operator why the package is suspicious. The individual should contact their supervisor immediately. Do not touch the package. If anyone has already touched the package, have them immediately wash their hands with soap and water. Follow the steps outlined on the Suspicious Packages Procedures Checklist in Attachment C.
3. Wait calmly until emergency response units arrive and enter the building. Identify yourself and show hazardous materials (HAZMAT) personnel where the suspicious package is located.

When notified of a suspicious package, supervisors, managers, and facility managers will:

1. Ensure compliance with actions outlined in Attachment C, Suspicious Packages Procedures Checklist;
2. Make a determination if a lock-down is necessary to contain the spreading of hazardous material and control personnel that may have been affected. If the situation is serious enough to warrant a lock-down, then no one will be permitted to leave unless authorized by the Fire and Emergency Services Incident Commander. The situation may warrant individual decontamination operations. If an evacuation of the area is warranted, then follow procedures outlined in the department's Emergency Action Plan concerning accountability and consolidation of personnel in a specified assembly area;

3. For a biological/chemical hazard only, have a knowledgeable employee turn off the HVAC System, any fans, or remote heaters and secure all windows and doors (remember to leave doors and windows open for an exploding device). Turn off all equipment that has cooling fans or can move air (i.e., computers, printers, network hubs, refrigerators).
4. Ensure that unit/agency personnel or anyone who entered the area remains in close proximity, but out of the high hazard area in case tests on the suspicious package are positive.
5. Plan on participating in decontamination operations;
6. Encourage personnel to remain calm and orderly; and
7. Ensure personnel follow the instructions of emergency personnel who assume command and control of the building and surrounding area.

V. Post-Incident Operations

1. Whether a device has been rendered safe or has detonated, the area will be sealed off by the local police until criminal investigators and EOD thoroughly investigate the area. If a device detonates, the most minute fragments are retrieved in order to determine the composition of the device. All persons not directly involved with the investigation will be restricted from the scene. However, for long-term investigations it may be necessary for affected unit personnel to augment the local police in securing the area.
2. All units/agencies involved in the incident should conduct an After Action Report (AAR) per Attachment F. At a minimum, the AAR should cover the nature of the incident, action taken, outcome and any additional information. The outcome of this AAR may generate changes to SOPs or identify additional training requirements. Submit completed AARs to Risk Management.

VI. References

1. Presidential Decision Directive 39 – U.S. Policy on Counter-terrorism(U)
2. Federal Emergency Management Agency Federal Response Plan, 16 June 2016

**Attachment A
Bomb Threat Checklist**

BOMB THREAT CHECKLIST



**Be Prepared
Be Aware
Be Ready**

1. Remain calm.
 2. Signal for someone to call the **local police or 911**
 3. Get the following information:
 - a. Exact time of call _____ .
 - b. Exact words of caller _____
 4. Questions to ask:
 - a. When is the bomb going to explode? _____
 - b. Where is the bomb? _____
 - c. What does it look like? _____
 - d. What kind of bomb is it? _____
 - e. What will cause it to explode? _____
 - f. Did you place the bomb? _____
 - g. Why? _____
 - h. Where are you calling from? _____
 - i. What is your address? _____
 - j. What is your name? _____
 5. Caller's voice (Circle one):

Calm	Disguised	Nasal	Angry	Broken
Stutter	Slow	Sincere	Lisp	Rapid
Giggling	Deep	Crying	Squeaky	Excited
Stressed	Accent	Loud	Slurred	Normal
- If the voice is familiar, who did it sound like? _____
- Were there any background noises? _____
- Remarks: _____
- Person receiving call _____
- Telephone number call received at _____
- Date _____

Attachment B
Bomb Threat Procedures Checklist

Individual Actions

1	Remain calm.	
2	Record dialogue on Bomb Threat Checklist.	
3	Keep caller on line as long as possible.	
4	Listen for background noises.	
5	Listen carefully to the caller's voice.	
6	Notify supervisor.	
7	Notify local police at 911.	
8	Remain on scene for police investigator.	

Leaders Actions

1	Notify local police.	
2	Assess the situation.	
3	Evacuate the building if the situation warrants.	
4	Take accountability for personnel.	

Attachment C
Suspicious Packages Procedures Checklist

1	Remain Calm.	
2	Do not open the package or letter.	
3	Do not shake or empty the contents.	
4	Put the package down gently in a closet or the safest place available without transporting the package out of the already affected area. Cover the substance and/or suspected package with a trash can or other material to prevent substance from becoming airborne.	
5	Do not carry the package or envelope, show it to others, or allow others to examine it.	
6	Do not share or in any way try to remove the contents.	
7	Do not attempt to pick up, sweep, or contain any spillage.	
8	Put the package or envelopes on a stable surface; do not sniff, touch, taste, or look closely at it or any contents that may have spilled.	
9	Do not touch your eyes, nose, or other body parts.	
10	Shut off Heating, Ventilation, Air Conditioning (HVAC) Systems, window air conditioning units, fans, and any equipment that might have a fan (e.g., computers, printers, servers, etc.).	
11	Isolate the package and close off the room by shutting all doors and windows.	
12	Thoroughly wash hands with soap and water.	
13	Call 911 for Police and Fire Department HAZMAT, notify supervisor.	
14	Advise fellow co-workers to avoid the area.	
15	Keep all potential exposed individuals in close proximity, but out of the high-hazard area.	
16	Don't leave the area until told to do so by responding emergency response personnel.	
17	Ensure all personnel who have touched the package/letter wash their hands with soap and water.	
18	List all persons who have touched the letter/package.	
19	Shower with soap and water.	

Attachment D Damage Control Measures









Personnel must know the actions to take on discovery of a device and measures to reduce damage. They must learn that if a suspicious item is actually located, it requires concise and immediate action. They must learn:

- NOT TO TOUCH THE DEVICE UNDER ANY CIRCUMSTANCES.
- If evacuation is not already accomplished, to immediately evacuate all nonessential personnel.

They must also know the measures to take to reduce damage if EOD determines that time allows. They must know to:

- Disconnect or shut off any gas lines to the facility.
- Open windows and doors (except for a bio/chem hazard).
- Remove items that may add to the explosive force (gasoline, lubricants, paint).
- Sandbag the area around the device, but never place any items on the device itself.
- Evacuate personnel further than the 330-foot range, preferably behind a windowless structure.

**Attachment E
Bomb Threat Stand-Off Distances**

Threat Description		Explosives Capacity ¹ (TNT Equivalent)	Building Evacuation Distance ²	Outdoor Evacuation Distance ³
	Pipe Bomb	5 LBS/ 2.3 KG	70 FT/ 21 M	850 FT/ 259 M
	Briefcase/ Suitcase Bomb	50 LBS/ 23 KG	150 FT/ 46 M	1,850 FT/ 564 M
	Compact Sedan	500 LBS/ 227 KG	320 FT/ 98 M	1,500 FT/ 457 M
	Sedan	1,000 LBS/ 454 KG	400 FT/ 122 M	1,750 FT/ 533 M
	Passenger/ Cargo Van	4,000 LBS/ 1,814 KG	600 FT/ 183 M	2,750 FT/ 838 M
	Small Moving Van/ Delivery Truck	10,000 LBS/ 4,536 KG	860 FT/ 262 M	3,750 FT/ 1,143 M
	Moving Van/ Water Truck	30,000 LBS/ 13,608 KG	1,240 FT/ 378 M	6,500 FT/ 1,981 M
	Semi-Trailer	60,000 LBS/ 27,216 KG	1,500 FT/ 457 M	7,000 FT/ 2,134 M

This table is for general emergency planning only. A given building's vulnerability to explosions depends on its construction and composition. The data in these tables may not accurately reflect these variables. Some risk will remain for any persons closer than the Outdoor Evacuation Distance.

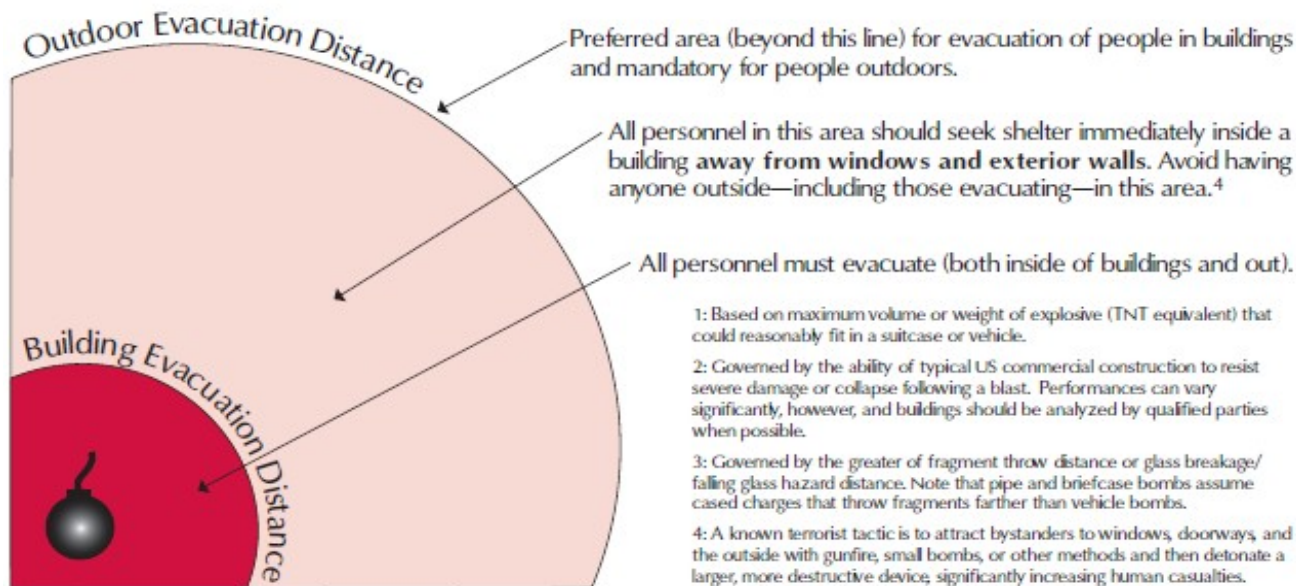

National Counterterrorism Center: https://www.nctc.gov/docs/2006_calendar_bomb_stand_chart.pdf

**Attachment F
After Action Report**

This After Action Report is intended to aid in business continuity plan evaluation and improvement by registering situation-response interactions, analyzing critical functions, determining coping strategy effectiveness and efficiency, and proposing adjustments and recommendations.

Overview:

Incident:

Date:

Location:

Participants

Type:

Setting:

Event:

Actions Taken:

Discoveries:

Description of issues discovered during the incident:

Corrective Action:

The following revisions will be made:

Action Items:

The following Action Items are in progress and will be completed by ____ weeks: **Date:**

Department Head

Date

Department Safety Coordinator

Date



County of El Dorado, California

Regulatory Compliance Program No. 5 Code of Safe Work Practices

I. Purpose and Scope

The County of El Dorado Code of Safe Practices (Attachment A) applies to all County employees. This regulatory compliance program was developed to help departments fulfill the requirements of Title 8 of the California Code of Regulations, Sections 1509(b), 1509(c) and 1510(a).

II. Responsibilities

A. Supervisors are responsible for:

1. Posting a copy of the County of El Dorado's Code of Safe Practices at each work area;
2. Ensuring that a copy of the Code of Safe Practices is readily available at each facility and job site;
3. Ensuring that each employee, when first hired, is directed to read the County's Code of Safe Practices and document that each employee has read it; and
4. Enforcing the County's Code of Safe Practices.

B. Employees are responsible for:

1. Reading and maintaining compliance with the Code of Safe Practices, and
2. Reporting all safety concerns to their immediate supervisor. If this is not possible, they must notify the Human Resources Department - Risk Management Division at 530-621-5565.

III. Recordkeeping

- A. Supervisors must document that each employee involved in construction activities has read the Code of Safe Practices.
- B. Employee training records must be maintained as per the County's records retention policy.

Attachment A

County of El Dorado Code of Safe Work Practices

****PLEASE POST THIS CODE OF SAFE WORK PRACTICES IN
YOUR WORK AREA AND AT ANY PROJECT IN THE FIELD****

Note: It is each department's responsibility to evaluate department-specific hazards and develop additional Codes of Safe Practices as necessary for the specific hazards. Any additional safety policies and procedures specific to your operation may not be included in the above posting. See your supervisor for more information.

- All employees shall read and familiarize themselves with the following safety-related resources:
 - Injury and Illness Prevention Program
 - A Violence-Free Workplace Policy
 - General Office Ergonomics, where applicable
 - Driving Safety, where applicable
 - Emergency Preparedness Programs
- All employees will follow these practices rules, render every possible aid to safe operations, and report all unsafe conditions or practices, accidents, injuries, near-miss incidents or occupational illnesses immediately to Risk Management or their supervisor.
- Managers are responsible for overseeing that their employees obey rules and regulations to ensure a safe work environment and taking action as necessary to obtain compliance from their employees.
- All employees shall be provided with training as it pertains to their job tasks.
- Horseplay and other acts that tend to place individuals at risk or affect the safety of others in the workplace are strictly prohibited.
- Avoid wearing inappropriate footwear or shoes with thin or badly worn soles.
- Know the location of all first aid kits and know how to contact EMS if needed.
- Substance abuse or other conditions that adversely affect the employee's safety, health, and behavior are not allowed at the workplace.
- Weapons are not permitted in the work environment unless specifically permitted per the employee's job classification.
- Files, materials, and supplies shall be stored safely.
- Employees shall practice good housekeeping. Work areas, including areas under or around desks, shall be kept free of boxes or debris and trash shall be placed in appropriate receptacles.
- Floors shall be kept clean and dry to prevent slipping hazards. Spills shall be cleaned up immediately.

- Check areas for tripping and fall hazards and make corrections to prevent incidents.
- Trash, garbage or waste containers shall not be allowed to overflow.
- Wash hands thoroughly before eating or drinking.
- File cabinet or desk drawers shall not be left open.
- The top drawer of a file cabinet that does not have full bottom drawers shall not be fully opened.
- VDT workstations shall be adjusted as appropriate for employee comfort and to relieve physical strain and unnecessary exertions, to the extent possible.
- Wear seat belts when operating equipment equipped with seatbelts.
- Proper lifting and carrying techniques and appropriate equipment shall be used. For example, when lifting heavy objects, the large muscles of the leg instead of the smaller muscles of the back shall be used. Always get help in lifting heavy loads.
- Employees shall not run electrical cords or any other cords, ropes, cables, or other trip hazards across aisles, walkways, corridors, passageways, stairways, or any other areas where people might be expected to walk. Electric cables and cords shall be secured to avoid trips and falls.
- All electrical equipment shall be plugged into appropriate wall receptacles.
- Extension cords are for temporary use only; do not drive over them with vehicles or heavy carts.
- Power strips shall be plugged directly into approved electrical outlets.
- Using three-pronged plugs is recommended to ensure continuity of ground.
- Lights or lighting fixtures shall not be tampered with or removed. Maintenance shall be contacted to repair or adjust the lighting as needed.
- Employees shall wear personal protective equipment or clothing (PPE) in all areas requiring PPE to be worn.
- Office equipment and hand tools shall only be used for their intended purpose.
- All equipment such as fans, paper cutters, and shredders shall have built in guards to prevent cuts and abrasions.
- Use of ladders or step stools shall comply with all safety instructions and design specifications of the equipment.
- Know the location and use of fire extinguishers and extinguishing equipment.
- Portable fire extinguishers shall not be operated, tampered with or removed except in an emergency and in accordance with safety procedures.
- Store material and equipment in a safe manner.
- Know the procedures for sounding a fire alarm or emergency evacuation. Employees shall be aware of the instructions in El Dorado County Emergency Preparedness program and know how to respond in the event of a fire or other emergency evacuation/situation.
- In the event of a fire, employees shall sound the alarm and evacuate using designated escape

routes.

- Upon hearing a fire alarm, employees shall stop work, proceed to the nearest clear emergency exit, and gather at the designated assembly point.
- Do not remove, deface or destroy any warning, danger signs, or barricades, or interfere with any form of accident prevention device or practice provided.
- Materials and equipment shall not be stored under egress stairways. Items shall not block access to fire extinguishers, or other firefighting equipment.
- All routes of egress shall be kept clear. Items shall not block or obstruct emergency exit doors, aisles, hallways, or stairways.
- Adequate aisle space shall be maintained. Do not block aisles, traffic lanes, fire extinguishers, gangways or stairs at any time.
- Electrical control panels shall not be obstructed. There shall always be a 36-inch clearance in front of this equipment.
- When storing high materials of any description, a minimum clearance of 18 inches between the top of the storage and the fire sprinkler head is required.
- Think about what could go wrong, and how to prevent problems and accidents.

In addition to the above general safe practices, the following safe practices relate to employees who work in the field and/or with power tools and/or equipment:

- Pre-plan and supervise all work to prevent injuries in the handling of materials and in working together with equipment.
- Avoid having loose or frayed clothing, or long hair, dangling ties, finger rings, etc. around moving machinery or other sources of entanglement.
- Get proper training for the specific equipment to be operated.
- Ask for help when unfamiliar with any aspect of equipment operations.
- Tie down ladders and all loose items to prevent movement should a sudden stop or accident occur when transporting equipment or supplies. Tarp loads as needed.
- Avoid taking shortcuts on the project. Use walkways, ramps, stairs, ladders, etc.
- Remove or clinch nails in lumber.
- Know the correct use and care of hand power tools.
- Install proper guards or shields on all power tools and do not remove them.
- Ensure that all power tools, extension cords, and electrical equipment are properly grounded and insulated.
- Inspect all tools before use and tag all damaged tools and equipment that may need repair. Do not use damaged tools.
- Review fall protection standards to ensure safety and compliance with regulations when work will be performed at elevations above 7 ½ feet high.

- Keep all tools and material away from the edges of scaffolding, platforms, etc.
- Use only approved safety cans for storage of combustibles and flammables.



County of El Dorado, California

Regulatory Compliance Program No. 6 Confined Space

I. Purpose and Scope

This written regulatory compliance program (RCP) specifies requirements to be followed by County of El Dorado employees assigned to perform permit-required and non-permit required confined space operations. The safety requirements for proper identification, assessment and entry into confined spaces identified as permit-required confined spaces are compliant with the California Code of Regulations (CCR) Title 8, Sections 5156-5158 (8CCR5156-5158) and must be strictly adhered to. Definitions of terms used in the Occupational Safety and Health Administration (OSHA) regulations are listed in Attachment A.

II. Evaluations and Classifications

A. Workplace Evaluation

1. The department director or designated person for each division will identify and evaluate known and potential confined spaces associated with division operations.
2. The department director or designated person for each division will prepare an inventory list of known confined space locations, types, and/or tasks.
3. This evaluation and inventory list will be reviewed and updated annually.

B. Confined Space Classifications

1. Confined spaces are defined as locations that:
 - a. Are large enough and so configured that an employee can bodily enter and perform assigned work;
 - b. Have limited or restricted means for entry or exit; or
 - c. Are not designed for continuous employee occupancy.
2. Non-permit confined spaces are defined as confined spaces that do not contain or have the potential to contain any atmospheric hazards capable of causing death or serious physical harm.
3. Permit-required confined spaces are defined as locations that:
 - a. Contain or have the potential to contain a hazardous atmosphere;
 - b. Contain a material that has the potential for engulfing an entrant (e.g., liquid, soil);
 - c. Contain inwardly converging walls or a floor that slopes downward and tapers to a smaller cross-section where an entrant could be trapped or asphyxiated; and
 - d. Contain any other recognized serious safety or health hazard or have the potential for rapid change in work environment (e.g., unsafe temperature, electrical shock, hazardous chemicals).

III. Responsibilities

- A. The Human Resources Department - Risk Management Division (Risk Management) will:
 1. Serve as a resource and support for confined space issues;
 2. Maintain, revise, and distribute this program to appropriate departments;

3. Assist in developing and presenting confined space safety training; and
4. Assist departments in any additional specialty air monitoring, testing, and selection of respiratory protection equipment.

B. Departments will:

1. Identify all operations that potentially involve confined space entry;
2. Determine if the confined space is a permit-required confined space;
3. Maintain a current inventory list of all known permit-required confined space locations, types, and/or tasks;
4. Ensure that a warning sign or label (temporary or permanent) is attached to the entry points of all known, permit-required confined spaces;
5. Ensure all permit-required confined spaces which are labeled must be posted. Signs will have languages similar or equal to:

DANGER

PERMIT- REQUIRED CONFINED SPACE

DO NOT ENTER UNLESS AUTHORIZED AND PROPER EQUIPMENT IS PRESENT

6. Ensure, whenever possible, permit-required confined spaces be posted with permanent signage;
7. Remote location permit-required confined spaces (e.g., maintenance holes, vaults, etc.) may be temporarily posted during entry operations; and
8. Ensure only trained personnel are assigned to confined space operations (e.g., attendant, entrant, or entry supervisor positions) and follow all aspects of this program prior to allowing any employee to enter the confined space.

C. Entry supervisors will:

1. Function as the on-site work supervisor having the authority and responsibility to determine if acceptable entry conditions exist and to authorize entry into a permit-required confined space;
2. Remain on-site at the location of permit-required confined space entry operations at all times that employees are in a confined space unless duties are transferred to another qualified employee in the event that he/she must leave the worksite;
3. Determine the appropriate type of communication system (e.g., radio, voice, etc.) to be used during confined space operations;
4. Perform the duties of attendant, as noted below, when necessary; and
5. When necessary, the entry supervisor/attendant will be provided from a department which occupies the facility with the confined space.

D. Attendants will:

1. Be assigned for all permit-required confined space operations at the entry to the confined space;

2. Know the hazards as well as the signs and symptoms of exposure associated with the assigned confined space entry operation, including the behavioral effects of hazard exposure;
3. Continuously maintain awareness of authorized entrants' activities, including an accurate count of entrants;
4. Remain outside the permit-required confined space until relieved by another authorized attendant;
5. Communicate with authorized entrants and monitor their activities;
6. Alert the authorized entrants when evacuation is necessary;
7. Summon rescue and emergency services (i.e., call 911) if authorized entrants need assistance to escape from permit-required confined space;
8. Warn against and prevent unauthorized entry into the permit-required confined space;
9. Inform the entry supervisor if unauthorized entry occurs; and
10. Perform non-entry rescues, as necessary, utilizing extraction equipment (i.e., the retrieval system or self-rescue).

E. Entrants will:

1. Follow all rules and instructions;
2. Report any accidents, injuries, or work-related problems to the supervisor; and
3. Follow job assignments as authorized entrant and/or attendant.

IV. Procedures

A. Job Planning

All potentially confined spaces must be evaluated to determine if they should be classified as a non-permit or permit required. Non-entry options for performing the work should be considered. All spaces will be considered permit-required confined spaces until the pre-entry procedures demonstrate otherwise. The following information must be obtained and evaluated prior to performing entry operations by a trained confined space entrant or supervisor.

1. Nature, type, and size of the permit-required confined space including means of exiting and ventilation;
2. Hazardous sources of energy that will require lockout/tag out (e.g., isolation);
3. Chemical hazards in the permit-required confined space, including hazardous atmospheres, sludge, scale, sewer gases, chemical, etc.;
4. Physical hazards, including electrical, noise, heat stress, slip, trip, fall, etc.;
5. Reason for entry (i.e., nature of operations);
6. Equipment to be operated for ventilation, lighting, cleaning, air monitoring, emergency extraction, etc.;

7. Anticipated duration of the job, work crew size, etc.; and
8. Determination of the appropriate type of communication system to be used during operations.

Air Monitoring

The air inside confined spaces must always be tested, from outside the space, before entry into any confined space. As a minimum, the air must be tested for percent oxygen content (OXY%), percent Lower Explosive Limit (LEL%) atmospheres, and parts per million of carbon monoxide (CO) and hydrogen sulfide (HS). Additional tests may also be specified. Refer to Attachment B.

1. A trained entrant or supervisor will ensure that pre-entry atmospheric testing is performed and results are recorded on the non-permit validation form (Attachment C) or confined space entry permit (Attachment D).
2. Representative atmosphere tests will be taken from at least three different levels and locations, or approximately every four feet including corners and low spots.
3. Air monitoring equipment will be maintained and calibrated following the manufacturers' recommendations by an appropriately qualified person.

B. Non-Permit Confined Space Entry Procedure

For classification as a non-permit confined space, the only hazards that may be present are limited means of entry / exit or that the space is not designed for continuous human occupancy. Non-permit entry into confined spaces may be allowed only when initial air monitoring confirms a non-hazardous atmosphere. Refer to Attachment B.

1. A trained confined space entrant or supervisor will:
 - a. Conduct air monitoring to verify a non-hazardous atmosphere;
 - b. Verify no hazards that could produce serious injuries exist; and
 - c. Use the confined space non-permit entry validation form to document the pre-entry evaluation (Attachment C).
2. Mechanical ventilation may be used to reduce air contamination for non-permit entry (yellow zone, Attachment B). If mechanical ventilation is necessary to eliminate air contaminants, an attendant, two way communication and continuous ventilation are required for non-permit confined space entry operations.
3. If initial air contamination is hazardous (orange zone, Attachment B) a permit is required.

C. Permit Required Confined Space Entry Procedures

Pre-entry evaluation will assess the size of the permit-required confined space, entry/exit access, chemical hazards, air quality, and work to be performed.

1. The entry supervisor must obtain the job planning information, conduct air monitoring and initiate an individual confined space entry permit for each space to record information obtained in the pre-entry evaluation (Attachment D).
2. When necessary (e.g., unusual conditions, hazardous atmospheric conditions or any

significant safety concern), the entry supervisor should review the confined space entry permit with the Department Director, Risk Management staff or designated person prior to signing off on the permit before work begins.

3. The entry supervisor must review the confined space entry permit with the job site employees.
4. The confined space entry permit must be posted at the entrance to the confined space during all entries authorized by the permit.
5. The entry supervisor or will ensure that all testing, ventilation, communication, lighting, barriers, ladders, and personal protective equipment required for an authorized entry is available, in good condition, and is used as required. All lighting must be explosion proof.
6. Prior to and during authorized entry, the entry supervisor must ensure the following:
 - a. The permit-required confined space is posted and unauthorized entry is prohibited;
 - b. All hazards have been identified, evaluated and mitigated as needed;
 - c. Acceptable entry conditions have been reviewed (Attachment B);
 - d. The permit-required confined space is isolated. Note: some spaces cannot be isolated (e.g., wet wells with no isolating valves or large mains);
 - e. The permit-required confined space is properly ventilated; and
 - f. The work area and confined space entry locations are marked and isolated to provide pedestrian, vehicle and/or other hazard barriers.
 - g. Safety data sheets (SDS) will be posted for chemicals used in confined spaces. Supervisors should brief entrants and attendants on the content of SDS.
7. The conditions in the permit-required confined space must remain acceptable for entry throughout the entire authorized entry. Air monitoring will be conducted continuously and results recorded every 15 minutes.
 - a. Permit-required confined spaces will be continuously ventilated during all entry operations to reduce to, or remain below, specified atmospheric levels of contaminants.
 - b. Ventilator will be positioned to blow air into, or pull air out of, the confined space as specified by the entry supervisor.
 - c. Ventilation will be continued for an adequate period of time before testing and entry, as well as at all times during entry.
8. The entry supervisor will assign at least one attendant outside the permit-required confined space to monitor the authorized entrant(s) and will review job tasks and safety responsibilities with both attendants and authorized entrants.

D. Control of Hazardous Substances and Energy

The entry supervisor will verify that all sources of hazardous substances or energy are

deactivated, de-energized, are restricted from operation (locked-out and tagged-out), and are verified as de-energized prior to authorizing employee entry.

1. Any machinery or other hazard that is electrically, mechanically, chemically, hydraulically, or pneumatically supplied must be de-energized and locked out prior to entry. Pneumatically and hydraulically supplied machinery or hazards must be depressurized and the air supply disconnected, locked out and/or tagged out.
2. Where applicable, any pipes, ducts or drains, which could introduce dangerous chemicals, pressure or water into the confined space, must be disconnected, blanked or capped. As an alternative, two consecutive shut-off valves can be closed and tagged out. Whenever possible, at least one valve should be chained and locked into the closed position.
3. Any drain valves for the confined space must be locked into the open position and tagged.

E. Safety Harnesses, Lifelines and Extraction Equipment

A lifeline and full body harness will be used for all permit-required confined space entry operations unless the retrieval equipment would increase the overall risk of entry or would not contribute to the rescue of the entrant. The lifeline must be attached to a retrieval system or a fixed anchor.

A retrieval system (i.e., safety harness, lifeline and extraction device) will be used for all permit-required confined space entry operation into vertical spaces more than five feet deep. The purpose of the retrieval system is to affect non-entry rescue by the Attendant in the event of a confined space emergency and to act as fall protection.

Extraction devices are primarily intended for top entry situations.

F. Shift Changes

In the event of a shift change, the initial shift personnel will exit the confined space and the existing confined space entry permit will be canceled. The shift going on-duty will follow all procedures for initial entry into a permit-required confined space. The on-duty shift entry supervisor will initiate, complete and authorize a new confined space entry permit.

G. Permit Completion Procedure

1. When the operation is complete or terminated, the authorized entrant(s) will be immediately removed from the permit-required confined space and the confined space entry permit canceled by the entry supervisor by checking the canceled box on the permit. The permit will be cancelled if any condition not allowed by the confined space entry permit arises in or near the permit-required confined space.
2. Problems encountered during entry will be noted on the confined space entry permit.
3. Following completion of each job, the confined space entry permit(s), or a copy, will be filed with the Department Director or designated person.
4. All canceled permits will be retained for at least 1 year (12 months) after cancellation.

H. Respiratory Protection

Consult with your supervisor to further evaluate hazards for any air contamination that cannot be eliminated with ventilation. Consult with Risk Management staff prior to using any respiratory protection equipment in a confined space. Air purifying filter cartridge respirators do not provide protection and cannot be used in oxygen deficient atmospheres. Refer to Attachment B.

I. Emergency Procedures

Preparation is essential for dealing effectively with emergency situations.

1. The entry supervisor will identify how fire/rescue/paramedic services can be summoned by locating the nearest operating telephone and/or radio. The telephone and/or radio must be tested to make sure they are operating properly. The exact worksite address, cross-streets, or location where the person summoning help can be met must also be identified.
2. The attendant must be prepared at all times to provide assistance in the event of an emergency and must always be prepared to call for help. The entry supervisor and/or attendant will have immediate access to a telephone or two-way radio for the purpose of requesting emergency rescue services.
3. The entry supervisor will maintain verbal communication with the attendant at all times during entry operations.
4. The attendant must NEVER enter the confined space to attempt rescue. The attendant will attempt non-entry rescue ONLY by requesting the entrants to evacuate and/or activating the extrication equipment.
5. The attendant or entry supervisor will contact the fire department to request emergency aid. When calling for help, the following information will be furnished:
 - a. Caller's name and call back phone number;
 - b. Address and exact location of the confined space; and
 - c. Nature of the emergency, including the number of workers affected, any known hazards, and the events leading to the emergency.
6. When emergency personnel arrive on-scene, the entry supervisor and/or attendant will:
 - a. Update the rescue personnel;
 - b. Have the confined space entry permit available for review; and
 - c. Assist as requested.

V. Training Requirements

- A. Any employee who enters a confined space (authorized entrant), serves as a stand-by (attendant), or supervises a job involving a confined space (entry supervisor) must receive training.
- B. No employee may be assigned to evaluate the hazards of a potential confined space or work in a permit-required confined space job until trained.

- C. New employee initial training will be provided on an as-needed basis by the department supervisor or designated person.
- D. Employees will not be eligible for confined space work unless they attend all training lectures; participate in all training exercises; and demonstrate proper use of test instruments, personal protective clothing and equipment, lifeline, harness, extraction device, ventilators, and other related equipment.
- E. The department director or designated person, in association with the qualified trainer, will verify that the training requirements have been satisfied. Certification will be documented and include the following:
 - 1. Employee name;
 - 2. Date of certification; and
 - 3. Name (and initials or signature) of the trainer.
- F. Training will cover the following topics:
 - a. Hazards of confined space operations;
 - b. Differences between non-permit and permit-required confined space;
 - c. The content of this regulatory compliance program;
 - d. The Cal/OSHA permit-required confined space standard;
 - e. Use of the confined-space entry permit;
 - f. Conditions prohibiting safe entry;
 - g. Duties of the entry supervisor, attendant, and authorized entry workers;
 - h. Use of test instruments, lifeline, harness, extraction device, and personal protective clothing and equipment; and
 - i. Emergency and rescue procedures.
- G. Training will be updated:
 - a. Whenever there is a change in entry procedures;
 - b. Whenever new hazards have been identified or there are inadequacies in an employee's knowledge and/or use of these procedures;
 - c. As needed based on changes to regulations and/or procedures; and/or
 - d. Annual refresher training.

VI. Program Evaluation

- A. This RCP will be re-evaluated annually and updated as needed.
 - 1. Risk Management staff will be responsible for initiating and documenting the annual program review.
 - 2. Entry supervisors may participate in each annual review.

B. Annual program review will include the following:

1. Review of canceled confined space entry permits for the last 12 months;
2. Review of the non-permit and permit-required confined space location/task inventories;
3. Training records;
4. Any known and/or documented confined space safety incidents; and
5. Air monitoring instrument, retrieval system, safety and other equipment condition, maintenance usage, etc.

Attachment A Definitions

Acceptable Entry Conditions

Environmental conditions inside a permit-required confined space where there are no atmospheric components potentially hazardous to health or safety.

Attendant

A person designated to remain outside one or more permit-required confined spaces to monitor the authorized entrants and performs all attendants' duties assigned on the entry permit.

Authorized Entrant

An employee who is authorized by the employer to enter a permit required confined space.

Buddy System

At least two persons equipped with approved respiratory equipment shall be on the job and communication shall be maintained between both or all individuals present.

Blanking or Blinding

The absolute closure of a pipe, line, or duct by the fastening of a solid plate (such as a spectacle blind or skillet blind) that completely covers the bore and that is capable of withstanding the maximum pressure of the pipe, line, or duct with no leakage beyond the plate.

Confined Space

A space that is a) large enough and so configured that an employee can bodily enter and perform assigned work; b) has limited or restricted means for entry or exit; and c) is not designed for continuous employee occupancy such as tanks, silos, vats, vessels, boilers, compartments, ducts, sewers, pipelines, vaults, bins, tubs and pits.

Double Block and Bleed

The closure of a line, duct, or pipe by closing and locking or tagging two in-line valves and by opening and locking or tagging a drain or vent valve in the line between the two closed valves.

Emergency

Any occurrence or event internal or external to the permit-required confined space that could endanger entrants or any condition not permitted on the entry permit including any failures of hazard control, monitoring, communication or lighting equipment.

Engulfment

The surrounding and effective capture of a person by a liquid or finely divided (flowable) solid substance that can be aspirated to cause death by filling or plugging the respiratory system or that can exert enough force on the body to cause death by strangulation, constriction, or crushing.

Entry

The action by which a person passes through an opening into a permit-required confined space and is considered to have occurred as soon as any part of the entrant's body breaks the plane of an opening into the space.

Entry Permit (permit)

The written or printed document containing specific information that is provided by the entry supervisor to allow and control entry into a permit space.

Entry Supervisor

The person responsible for determining if acceptable entry conditions are present at a permit space where entry is planned, for authorizing entry and overseeing entry operations, and for terminating entry as required.

Hazardous Atmosphere

An atmosphere that has the potential to cause death, incapacitation, impairment of ability to self-rescue, acute illness or delayed illness that can result in injury from one or the combined effects of the following causes:

1. Flammable gas, vapor, or mist in excess of 10 percent of its lower explosive limit (LEL);
2. Atmospheric oxygen concentration below 19.5 percent or above 23.5 percent;
3. Atmospheric concentration of any substance for which a permissible exposure limit is published and which could result in employee exposure in excess of that permissible exposure limit (e.g., carbon monoxide greater than 25 ppm, or hydrogen sulfide greater than 10 ppm) or any other atmospheric condition that is immediately dangerous to life or health.

Note: Flammable gases may also be toxic. Decreased oxygen levels may be caused by displacement of oxygen by a toxic substance.

Hot Work Permit

The written authorization to perform operations capable of providing a source of ignition as per County of El Dorado Regulatory Compliance Program No. 14.

Immediately Dangerous to Life or Health (IDLH)

Any condition that poses an immediate or delayed threat to life or that would cause irreversible adverse health effects or that would interfere with an individual's ability to escape unaided from a permit space.

Inerting

The displacement of the atmosphere in a permit space by a noncombustible gas to such an extent that the resulting atmosphere is noncombustible.

Isolation

The process by which a permit-required confined space is removed from service and completely protected against the release of energy and material into the space by such means as blanking or blinding; misaligning or removing sections of lines, pipes, or ducts; a double block and bleed system; lockout or tag out of all sources of energy; or blocking or disconnecting all mechanical linkages.

Line Breaking

The intentional opening of a pipe, line, or duct that is, or has been, carrying flammable, corrosive, or toxic material, an inert gas, or any fluid at a volume, pressure, or temperature capable of causing injury.

Non-permit Required Confined Space

A confined space that does not contain or have the potential to contain any atmospheric or other hazard capable of causing death or serious physical harm.

Oxygen-deficient Atmosphere

An atmosphere containing less than 19.5 percent oxygen by volume.

Oxygen Enriched Atmosphere

An atmosphere containing more than 23.5 percent oxygen by volume.

Permit-required Confined Space

A confined space that has one or more of the following characteristics:

1. Contains or has a potential to contain a hazardous atmosphere;
2. Contains a material that has the potential for engulfing an entrant;
3. Has an internal configuration such that an entrant could be trapped or asphyxiated by inwardly converging walls or by a floor which slopes downward and tapers to a smaller

cross-section; and/or

4. Contains any other recognized serious safety or health hazard.

Permit-required Confined Space Program

The County of El Dorado's overall program for controlling and, where appropriate, for protecting employees from permit space hazards and for regulating employee entry into permit spaces, also known as Regulatory Compliance Program Number 6.

Permit System

The written procedure for preparing and issuing permits for entry and for returning the permit space to service following termination of entry.

Prohibited Condition

Any condition in a permit space that is not allowed by the permit during the period when entry is authorized.

Rescue Service

The personnel designated to rescue employees from permit spaces.

Retrieval System

The equipment (including a retrieval line, chest or full-body harness, wristlets, if appropriate, and a lifting device or anchor), used for non-entry rescue of persons from permit spaces.

Testing

The process by which the hazards that may confront entrants of a permit space are identified and evaluated.

Ventilating

The process where clean fresh air is blown into a permit-required confined space while persons are in the space.

**Attachment B
Confined Space Acceptable Entry Condition Guide**

Decision	Oxygen	Lower Explosive Limits (LEL's)	Carbon Monoxide	Hydrogen Sulfide
<u>Normal Air</u>	20.9%	0%	0ppm	0ppm
<u>Non-Hazardous Atmosphere</u> Permit may be required Consult with supervisor if normal atmosphere cannot be achieved	19.5-23.5%	Less than 10%	Less than 25ppm	Less than 10ppm
<u>Hazardous Atmosphere</u> Permit Required Entry allowed with supplied air or SCBA only. Consult with supervisor and Risk Management.	16-19.5% OR more than 23.5%	10-19%	25-500ppm	10-100ppm
<u>No Entry Allowed</u>	Less than 16% OR more than 23.5%	More than 20%	More than 500ppm	More than 100ppm

Mechanical ventilation may be used to achieve non-permit entry conditions only when initial air monitoring results are non-hazardous (yellow zone).

If air quality cannot be improved to normal with mechanical ventilation, further investigation is required to determine and address the cause of low / high oxygen or presence of other toxins.

Permit is required if initial air quality does not meet yellow zone, the cause of low/ high oxygen is unknown or other any other safety or health hazards exist.

Do not enter a confined space using respiratory protective equipment unless specifically reviewed and approved by Risk Management staff.

**Attachment C
Confined Space Non-Permit Validation
(Including entry into manholes, sumps and basins)**

Confined spaces may be entered without the need for a written permit or attendant provided that the space contains no air contaminants or safety hazards. All confined spaces will be considered permit-required until the pre-entry evaluation confirms no hazardous conditions. A trained confined space supervisor or entrant must complete the following pre-entry check list to confirm the space is non-permit.

- | | | |
|--|------------------------------|-----------------------------|
| 1. Have you notified the supervisor that an entry is to be made? | <input type="checkbox"/> YES | <input type="checkbox"/> NO |
| 2. Have you verified that no hazards exist? (e.g. engulfment, electrical or atmospheric) | <input type="checkbox"/> YES | <input type="checkbox"/> NO |
| 3. Did you lockout and block sources of hazardous energy or substances leading to the immediate area? | <input type="checkbox"/> YES | <input type="checkbox"/> NO |
| 4. Are there large (greater than 12 inch) or fast flowing laterals? | <input type="checkbox"/> YES | <input type="checkbox"/> NO |
| 5. Did you survey the surrounding area to identify hazards such as drifting vapors from the tanks, piping, or sewers? | <input type="checkbox"/> YES | <input type="checkbox"/> NO |
| 6. Does your knowledge of the area indicate that it will remain free of dangerous air contaminants or engulfment hazards while occupied? | <input type="checkbox"/> YES | <input type="checkbox"/> NO |
| 7. Has the gas detector been bump tested at the beginning of the shift? | <input type="checkbox"/> YES | <input type="checkbox"/> NO |
| 8. Did you sample the atmosphere within the space to determine whether hazardous air contamination and/or oxygen deficiency exists? | <input type="checkbox"/> YES | <input type="checkbox"/> NO |
| 9. Did the atmosphere check as acceptable (no alarms)? | <input type="checkbox"/> YES | <input type="checkbox"/> NO |
| 10. Will the atmosphere be continuously monitored while the space is occupied? | <input type="checkbox"/> YES | <input type="checkbox"/> NO |
| 11. Have you notified your supervisor when you have exited the space? | <input type="checkbox"/> YES | <input type="checkbox"/> NO |

If any questions are answered NO, a permit entry is required. If mechanical ventilation is needed to eliminate air contaminants, an attendant and two way communications are required. Note: Not all laterals to sewer or storm drains require blocking, only those with known hazards or have a history of hazards.)

TIME	REQUIRED TESTS OF AIR IN THE CONFINED SPACE						TIME	REQUIRED TESTS OF AIR IN THE CONFINED SPACE					
	LEL %	OXY %	H ₂ S PPM	CO PPM	OTHER ¹			LEL %	OXY %	H ₂ S PPM	CO PPM	OTHER ¹	
					PPM	PPM						PPM	PPM
Permit Required if:	Is > 10%	Is not 19.5 – 23.5%	Is not < 10 ppm	Is not < 25 ppm			Is > 10%	Is not 19.5 – 23.5%	Is not < 10 ppm	Is not < 25 ppm			

If oxygen levels are not normal (20.9%) further investigation is required to determine the cause and possible presence of toxins. Contact your supervisor or the Safety Office (621-5565) if you have any questions.

Job Location: _____

Date: _____

Printed Name: _____

Signature: _____

Attachment D Confined Space Entry Permit

Facility Location _____ Date: _____
 Job No.: _____ Shift: _____ Entry Duration: _____
 Address: _____
 Work Plan: _____
 Confined Space Description _____
 Anticipated Hazards: _____

CONFINED SPACE SAFETY CHECKLIST	YES	N/A	EMPLOYEE SIGN-IN ⁴
All lines leading to and from the confined space have been isolated			1. (Print Name) Signature:
Electrical service de-energized/disconnected and locked out/tagged out			
All ignition sources removed and isolated			2. (Print Name) Signature:
Continuous ventilation equipment in use and bonded and grounded			
Special warning signs posted			3. (Print Name) Signature:
Explosion proof lighting/electrical equipment inspected and in use			
Required personal protective equipment inspected, in good condition, and in use			4. (Print Name) Signature:
Safety standby attendant trained in emergency procedures and CPR			
Emergency equipment (fire ext., first aid kit) ready for use			5. (Print Name) Signature:
Area surrounding confined space free of hazards			
Air monitoring instruments checked, operating properly, and in use			6. (Print Name) Signature:
Confined space atmosphere monitored prior to entry			
Hot work permit complete for welding, cutting, soldering, etc...			7. (Print Name) Signature:

TIME (15 min intervals)	REQUIRED TESTS OF AIR IN THE CONFINED SPACE						TIME	REQUIRED TESTS OF AIR IN THE CONFINED SPACE					
	OTHER ¹							OTHER ¹					
	LEL %	OXY %	H ₂ S PPM	COg PPM	PPM	PPM		LEL %	OXY %	H ₂ S PPM	CO PPM	PPM	PPM
Pre-Entry													
No entry when levels? are: CALL SAFETY OFFICER	More than 20%	<16% or >24%	>10 ²	>25 ³			No entry when levels are: CALL SAFETY OFFICER	More than 20%	<16% or >24%	>10 ²	>25 ³		

SPECIAL INSTRUCTIONS: _____

Approval:

Entry Supervisor

Reviewed by Division Manager or Designated Person

¹ When appropriate, test for other toxic contaminants.

³ PEL for CO.

² PEL for H₂S.

⁴ Sign in following safety briefing by Entry Supervisor.



County of El Dorado, California

Regulatory Compliance Program No. 7 Crisis Communication Plan

I. Purpose and Scope

The County of El Dorado (County) Crisis Communication Plan outlines the roles, responsibilities, and protocols that will guide the County in promptly sharing information internally and externally during an emergency or crisis. Its purpose is to help manage communications around a crisis or any potential, serious negative repercussions for the organization and those it represents. The County will use multiple mediums to reach as many people as possible with accurate, timely information. This is especially important in the first hours and days of an emergency or a crisis.

The mission of effective crisis communications for the County is as follows:

When speaking with its employees, the media, and public, the County will provide factual information and messages most beneficial to the organization and those it represents. The goal is to be open, accountable, and accessible to all audiences, while also being mindful of legal and privacy concerns. The messages should be responsive as well as provide clear solutions/actions, reinforcing the County's position of community leadership.

Objectives of this crisis communication plan are as follows:

- A. Prepare County staff and Board of Supervisors to effectively and nimbly manage crisis communications;
- B. Communicate facts as quickly as possible, updating information regularly as circumstances change, to ensure the safety of the community and the continued operation of essential services;
- C. Help staff respond in a unified, professional manner that reinforces leadership and loyalty;
- D. Strategically enhance the organization's brand/role, and the public understanding of the value provided by the County;
- E. Manage the distribution of critical, sometimes sensitive, information to employees, media, and public;
- F. Inform staff, Board of Supervisors, and volunteers of the County's position to help shape a consistent sector-wide response; and
- G. Establish a key spokesperson(s) for the organization.

For the purposes of this plan, a crisis is defined as a significant event that prompts significant, often sustained, news coverage and public scrutiny and has the potential to damage the institution's reputation, image or financial stability. A crisis could be precipitated by an emergency or a controversy. An emergency is a fire, hurricane, crime, or other event that presents a threat and typically involves a response from police, fire, or emergency medical personnel. A controversy better describes events such as a major protest or a case of employee misconduct.

The following possible crises that the County could encounter fall into general categories. These categories and examples are an attempt to anticipate the kinds of crises that are possible or likely, helping to remove the element of surprise and to ensure more complete preparation. The scenarios are not intended to be a complete list of all types of crises that could be encountered.

- A. Natural Disasters (e.g., hurricanes, flooding, tornadoes, wildfires, or facility fire)

- B. Criminal or legal action (e.g., staff or volunteer charged with a crime, sexual harassment lawsuit, or wrongful termination action brought against the County)
- C. Violent acts, demonstrations, death, or violent injuries (e.g., hostage situation, shooting at a County facility, demonstrations against the County, staff injured or killed while traveling)
- D. Personnel crises (e.g., resignation or firing of staff member, hospitalized staff member, staff member accused of sexual misconduct)
- E. Perceived crises (e.g., misunderstanding of a County position or action)
- F. Financial crises (e.g., embezzlement by an employee or volunteer, failure of a bank that holds County funds)

II. Responsibilities

All crises should be immediately reported to the County's Chief Administrative Officer. There should be one designated crisis management lead person, directing and coordinating all aspects of the organization's response, including managing the messages and the media. There should also be one designated spokesperson that actually interacts with the media and other inquirers. Only the chief spokesperson and back-up spokespeople are authorized to release information to the media and to the public. All other staff members should be professional and helpful to the media by connecting them with the spokespeople, but will neither speak to the media, nor provide any information. It is the responsibility of the spokesperson to deliver comments guided by professionalism and transparency, and serve to mitigate the crisis. Personnel matters are to always remain confidential.

The following list of departments will make up the Crisis Communications Team; the CAO or his/her designee will add other team members, as appropriate under the circumstances:

- Chief Administrative Officer or designee – chair
- Department Heads, as required per department
- County Sheriff's Office of Emergency Services
- County Counsel
- Risk Management
- Public Information Officer

III. Procedures

A. Convening the Crisis Communications Team

The Crisis Communications Team will convene when the CAO or designee declares an emergency. Given the urgency of rapid communications, the Crisis Communications Team has the authority to begin taking action immediately until a broader decision can be made about how the County should proceed. Also, the CAO may identify a potential crisis or controversy that is not an immediate emergency and assemble the Crisis Communications Team to prepare a communications strategy – again, as part of a coordinated County response. The CAO or his/her designee will contact each member by phone and/or email anytime there exists a need to convene.

B. Location

The Crisis Communications Team headquarters for most crises will be the Board of Supervisors chambers at 330 Fair Lane, Placerville, CA. This room may be replaced with another facility in the event of an extended crisis or emergency. The primary back-up location is the Office of Emergency Services conference room at 330 Fair Lane, Placerville, CA.

C. Implementation

The Crisis Communications Team will implement some, or all, of the steps outlined below based on circumstances. Throughout a crisis, the team will meet frequently to review changing facts, assess whether key messages are reaching audiences, and determine whether strategies need to change. In an emergency, the goal is to issue first communication to key audiences within 30 minutes of notification of the event, with regular updates as needed. Some situations may require even faster initial communications.

D. Immediate Response

The following steps are to help manage communications in an event of a crisis. Be sure to record all actions taken and related coverage gained in order to evaluate efficacy and measure intended plan objectives. Modify the plan after evaluation if needed. The team will carry out these initial tasks immediately:

1. Where equipped, activate outdoor sirens/public address system for immediate threats (tornado, gunman, etc.);
2. Send emails, text messages, and an alert through ADS. An ADS level message would go to all active employees who are logged in at that time. A "pop up" message would appear on all County computers that are members of the network. Broadcast messages through ADS are coordinated through the Information Technologies department;
3. Post notification on the EDCNET website (<http://edcnet/>).
4. Initiate phone tree for Severe Weather/Emergency Conditions notification process.
5. Send management memo as appropriate to department directors.
6. Update Severe Weather/Emergency Conditions phone line.
7. Send notification email to department safety coordinators for dissemination, as appropriate.
8. Send media alert as appropriate.
9. Send messages and update content through the accounts on Twitter and/or Facebook, as appropriate.
10. Create incident-specific blogs to convey information directly to particular audiences.
11. Convene the Crisis Communications Team.
12. Convene other communicators for emergency call center or other needs.

E. Secondary Response

Once the Crisis Communication Team convenes, the following tasks will be carried out by this team:

1. **Designate a secretary** who can maintain meeting notes, to-do lists, and information files on the ongoing crisis and other items.
2. **Review and write down known facts** – those that can and cannot be released to the public — and determine whether a response is needed, and if that response is needed for all of the County’s key audiences. These facts will be used to fill in templates for news releases, text messages, and other items that have already been developed. It is critical as the situation changes for new fact sheets to be developed. **Why?** These fact sheets can be used to update websites, emails, news releases, and other communication channels. They will also help guide the team’s overall strategy as events unfold.
3. **Develop several key messages** that will be included in all County communications. One message typically will address what the County is doing to ensure the safety of employees and other community members. Another may need to be forward-looking and address what we are doing to make sure the crisis, or a problem with our response, doesn’t happen again. All of the messages should evolve as circumstances change but will always aim to restore and maintain confidence and calm, balancing a sense of concern with resolve and action.
4. **Determine who will act as spokespeople** – both a senior leader of the County and someone charged primarily with communications responsibilities. The senior leader will be the public face of the County, while the communicator will run briefings and handle media questions between such formal press gatherings. Designate one or more members of the Crisis Communications Team to communicate key messages and emerging facts to those spokespeople and handle any last-minute media training. It is critical that senior leaders have copies of the most recent news releases and other messages so everyone is clear on what is being shared with the public. **Why?** In a time of emergency, it is critical for a high-ranking leader of the County – in most cases, the CAO – to be the County’s public face and take the lead in communicating key messages and answering questions. Such action illustrates that the situation is under control and that efforts are being made to address any questions that have arisen. It also serves to calm various audiences. As the situation evolves, the senior leader acting as the key spokesperson may change.
5. **Update EDCNET and public-facing County websites.** The County will regularly update on the intranet (EDCNET) and external website as primary sources of updates, linking from there to other pages with detailed information as needed. The County may also contact people via its Twitter and Facebook accounts. The director of communications, working with the Information Technologies Department, will take responsibility for overseeing all of these changes and needed updates.
6. **Assign communicators**, as needed, to handle phone calls, using a script developed from the key messages and facts the Crisis Communications Team has developed. These staffers should reach out to other units that handle multiple calls during a crisis. As part

of this effort, a separate log will be maintained to record all calls and interview requests from members of the media. These staffers will be responsible for ensuring that all calls are returned. **Why?** Our policy is always to be as responsive as possible to news media. During a crisis, it is important to maintain an organized log of interview requests so that calls are returned promptly. It is a missed opportunity if members of the media don't know our key messages and facts as we understand them.

7. **Develop communications from the CAO**, as appropriate. It may be necessary for the CAO to communicate to the employees about the emergency, including department heads and safety coordinators who can then disseminate the information within their departments. Communications from the CAO may also include statements to the media.
8. **Open a media center**, and determine whether a press conference(s) should be held. During crisis situations it needs to be determined if access needs to be restricted to ensure the safety of the employees and public, or to avoid disruption to essential services and programs. A designee in the Chief Administrative Office will be responsible for securing a conference room, bringing needed supplies (including identification badges, media guidelines, and press packets), and determining a schedule for 24-hour staffing.
9. **Evaluate how to help our community recover**, return to normal and, if needed, regain faith in the County after the trigger event of the crisis is over, in coordination with the senior leadership. This may include the need for town hall meetings, letters from the Board of Supervisors and/or CAO expressing sympathy, detailed plans to prevent another such crisis, etc.
10. **Within 10 days of the end of the event, assess how this plan functioned**, address any needed updates and recognize the work of partners whose help was invaluable. (i.e., assistance from communicators from other units or organizations).

F. Approvals of outgoing information

Typically, an approach of multiple approvals will be used prior to distribution of communications pieces, including emails and news releases. That system will not work in a crisis. Seconds matter in a crisis, and we will be judged by how quickly we share information with key audiences.

As a matter of policy, the County is committed to trying to meet these expectations. It recognizes the need for unusually crisp decision-making during a crisis to enable rapid, accurate communication in coordination with the institution's broader process. We have developed templates that have been approved in advance by senior officers and legal counsel to expedite the approval process during a crisis. Final approval for all communications rests with the CAO or his/her designee.

G. Staffing

It may be necessary to have additional help. The CAO has the authority to enlist the help of communicators from across the County and assign them as needed to the crisis response.

H. The End of the Crisis

The CAO will determine when an emergency has ended and routine communications processes can resume. The decision to declare the emergency over will trigger a review of how the crisis was handled and how communications can improve.

IV. Training Requirements

A. Education and Testing

The Chief Administrative Office communications director will take the lead in educating employees and the community about how and when they would get messages from the County in an emergency. The County will conduct a semi-annual drill of emergency management and the crisis communications plan will be tested at these times with participation by members of the Crisis Communications Team. Communication tools, which include the ADS system, email, text messaging, websites, and phone lines, as applicable, will also be tested.

V. Program Evaluation

- A. This plan will be reviewed on a semi-annual basis. The communications director will update phone lists for members of the Crisis Communications Team as well as media lists and fact sheets. The Department of Information Technologies will oversee updates and improvements to email lists for internal audiences.

Attachment A Crisis Communications Checklist Overview

Immediately following a crisis:

- Safety – Ensure safety of all staff, citizens, and site. Call 911, if needed.
- Notification – Notify the CAO immediately, who will then determine if the Crisis Communications Team needs to convene.
- Crisis Communications Team – Key staff will convene to strategically review the situation and manage the communications surrounding the issue.

Note: In some cases, a larger Crisis Management Team may be needed when action surrounding the crisis involves more than just handling communications.

Before going public:

- Determine a crisis communications lead person responsible for ensuring all tasks are completed.
- Determine the crisis communication spokesperson that will answer all media and other inquiries.
- Assess the situation to determine the facts.
- Determine appropriate response/action.
- Create plan of action for internal and external communications.
- Develop factual, detailed messages that reflect the status of the crisis, the County's response, and, if possible, proactive steps to resolve the situation.
- Prepare talking points and provide a script for the receptionist receiving incoming calls.
- Determine if a press release, social media, web, and/or voicemail updates are necessary. (In most cases, timely updates should be posted to all points of public entry, both on- and off-line.)
- Assess what resources are necessary to manage the crisis (i.e., cellphone availability, press conference needs, on-location resources signs, lectern, visuals, etc.).
- Appoint staff for the following duties:
 - To serve as the official spokesperson and manage media.
 - To keep the Board of Supervisors apprised.
 - To contact partners, allies, etc. and assist with sector-wide talking points if appropriate.
 - To record crisis details, actions taken, external responses, and resolution.

Going public:

- Begin placing telephone calls to critical internal audiences, including staff, board, etc.
- Begin media and other external audience outreach; use press release if appropriate.
- Update the website.

- Update all social media pages.
- Update the organization's voicemail.
- Evaluate message effectiveness as the situation progresses.
- Implement methods for updating key audiences with ongoing information.
- Distribute post-crisis communications to key media, key contacts, etc.

Attachment B

Situational Assessment Questions

The Crisis Communications Team will assess the situation, determine facts, and begin delegation. Questions to help devise appropriate crisis communications response include, but are not limited to:

- What is the situation? What will happen next?
- Who on staff needs to be involved?
- What immediate steps need to be taken?
- What is known and who already knows it?
- Is there potential public interest? Does the issue have traction (will it become anything in the news)?
- Who will be affected?
- What are people feeling – what emotions need to be considered?
- What information is needed and who beyond organizational staff need to get it? When will it be available?
- What should the organization do about it? Proactive vs. reactive?
- Contact or refer to another organization?
- What can and cannot be said? What are the organization's privacy policies?
- Is legal or public relations counsel needed?
- Who will communicate the response as spokesperson?
- How will the response be communicated?
- Who will begin staff and Board of Supervisors phone trees?



County of El Dorado, California

Regulatory Compliance Program No. 8 Emergency Action Plan

I. Purpose and Scope

This regulatory compliance program (RCP) applies to all emergency action plans per California Occupational Safety and Health Administration (Cal/OSHA) Title 8, Sections 3220 Emergency Action Plans and 6184 Employee Alarm Systems.

II. Responsibilities

The County of El Dorado (County) must have an Emergency Action Plan (EAP) whenever a Cal/OSHA standard in this part requires one. The requirements in this section apply to each such EAP.

III. Procedures

An EAP must be in writing, kept in the workplace, available to employees for review, and shall cover those designated actions departments and employees must take to ensure employee safety from fire and other emergencies. Each department shall establish a written EAP that is site-specific and includes at a minimum:

- A. Procedures for reporting a fire or other emergency;
- B. Procedures for emergency evacuation, including type of evacuation and exit route assignments;
- C. Procedures to be followed by employees who remain to operate critical plant operations before they evacuate;
- D. Procedures to account for all employees after evacuation;
- E. Procedures to be followed by employees performing rescue or medical duties;
- F. The name or job title of every employee who may be contacted by employees who need more information about the plan or an explanation of their duties under the plan;
- G. The types of evacuation to be used in emergency circumstances; and
- H. A site-specific employee alarm system which complies with Article 165 (Attachment A). If the employee alarm system is used for alerting fire brigade members, or for other purposes, a distinctive signal for each purpose shall be used.

A department-specific EAP template is provided in Appendix A.

IV. Training Requirements

Before implementing the EAP, the department shall designate and train a sufficient number of persons to assist in the safe and orderly emergency evacuation of employees. The employer shall advise each employee of his/her responsibility under the plan at the following times:

- A. Initially when the plan is developed;
- B. Whenever the employee's responsibilities or designated actions under the plan change; and
- C. Whenever the plan is changed.

The Department shall review with each employee upon initial assignment those parts of the plan which the employee must know to protect him/herself in the event of an emergency. The written plan shall be kept at the workplace and made available for employee review.

V. Program Evaluation

- A. Each department shall review their EAP annually and submit an updated copy or notification of no changes to the Human Resources Department - Risk Management Division.

Appendix A
Emergency Action Plan Template



Emergency Action Plan

[Department Name-Division]

[Building Name and Address]

[Date or Revision Date]

Note: This template is general in nature. If there are other emergency situations that you encounter in your location, include those as well. Each emergency action plan needs to be site specific. Examples of additional possible emergencies may include frequent threats of violence from consumers, close proximity to manufacturing facilities and being located near railroad lines.

I. Purpose and Scope

The purpose of this Emergency Action Plan is to establish procedures for safely and effectively managing an emergency event for the [enter facility name]. All employees, supervisors, and managers are expected to follow the procedures outlined in this plan to ensure that employees and consumers are protected from any further harm during an emergency situation.

This Emergency Action Plan covers those designated actions managers and employees must take to ensure employee and consumer safety from fire and other emergencies. This plan includes: emergency escape procedures and emergency escape route assignments; procedures for employees who have to stay to operate critical plant operations before they evacuate (if applicable); procedures to account for employees after emergency evacuation has been completed; rescue and medical duties for those employees who are to perform them; the preferred means of reporting fires and other emergencies; and individuals who can be contacted for further information about the plan.

Authority: California Code of Regulations, Title 8, Sections 3220, 3203, 6184, NFPA 1 Uniform Fire Code, section 10.9.

II. Responsibilities

A. Person(s) responsible for emergency planning and information is/are:

[Name of person(s), Title]

[Contact Number]

B. Responsibilities of the Emergency Response Team

The goal of the Emergency Response Team is to assist in the orderly evacuation of employees and consumers from a building or area during an emergency or assist with shelter in place procedures if warranted. The duties of the Response Team are as follows:

1. Be familiar with the content of this plan.
2. Alert staff of emergency situations.
3. Ensure that staff and consumers are appropriately evacuating the facility or area based on the escape route assignments (see diagrams in Attachment A).
4. Assist in the evacuation of consumers and staff with disabilities that preclude them from using elevators during emergency situations, or altering security, fire, and police personnel of the last known location of the individuals.
5. Be current on CPR/AED/First Aid certifications and perform medical duties as necessary to employees and citizens during emergency situations.
6. Extinguish small fires with the use of a fire extinguisher.
7. If instructed, account for all employees and citizens at the designated meeting location(s).

The list of the primary and secondary responders is located in Attachment B. Note: The number of designated responders depends upon the size of the facility and the number of employees that work at that location. Larger facilities should have at least two responders per floor and at least one alternate. Smaller facilities can get by with one responder and one alternate.

C. Training

Emergency Response Team members will be trained and made aware of their duties so that they can assist in the safe and orderly emergency evacuation of employees. They shall be made aware of their responsibilities under this plan:

1. Initially when the plan is developed;
2. Whenever the employee's responsibility under the plan changes, and
3. Whenever the plan is changed

D. Responsibilities of the Employees

The success of this Emergency Action Plan in times of emergencies hinges on employees knowing the procedures outlined in this plan and acting upon them in an appropriate manner.

Before an emergency, employees shall:

1. Become familiar with the contents of this plan to include who to report emergencies to, the assigned evacuation routes for the facility, and the designated meeting locations.
2. Actively participate in emergency drills and treat them as if they are real.

During an emergency:

1. Assist an Emergency Response Team member if asked.
2. Listen and wait for directions on how and when to evacuate the facility from emergency response team members, security, police, or fire personnel.
3. Report any emergencies such as a bomb threat or threats of violence to your supervisor first and immediately.
4. Follow the assigned escape route procedures to avoid crowding at the exits.
5. Report immediately to your designated meeting location upon evacuating the facility. Do not take any side trips.
6. Never go back into the facility to retrieve personal belongings.

III. Procedures

A. Fire or other emergencies

Report fires and other emergencies immediately, first to your supervisor, then to the responsible person(s) listed above. When warranted, call 9-1-1. Be prepared to provide the responder with the nature and location of the emergency. Our address is:

[Enter facility name]

[Enter facility address]

[Enter major cross streets]

[Enter facility phone number]

B. Employee Alarm Systems

The employee alarm system for this facility provides warning so that employees can escape safely from the workplace or the immediate work area. The employee alarm system that has been established for this facility is as follows:

[Insert primary method of how all employees in the facility are notified of an emergency]

Note: Methods include but are not limited to: manual pull box alarms, public address systems, radio, or telephones. If phones are used as a primary means of reporting, telephone numbers shall be conspicuously posted nearby.

[Insert procedures for sounding emergency alarms in the workplace]

C. Evacuation Route and Assembly Area Map/First Aid Kits

1. Evacuation Routes and Maps

The evacuation routes and assembly area maps are posted by every main exit. Employees are to become familiar with all evacuation routes and their assembly point. See attachment A for evacuation maps for each floor(s) of this facility.

2. Location of First Aid Kits and AEDs

As noted on the evacuation maps in Attachment A, the First Aid Kits and AEDs are located [enter locations of first aid kits and AEDs].

3. Designated Meeting Locations

Once employees have evacuated the facility, they must meet [enter location(s) where employees are required to meet] to check in with the [enter either emergency responder or supervisor] who will be accounting for individuals. Those employees who do not show up to the designated meeting location will be presumed to still be in the building and fire and law enforcement personnel shall be notified of their absence immediately. Note: Attach a map of the facility and surrounding areas where employees are required to meet upon emergency evacuation.

Procedures for Critical Plant Operations

The operation of this facility does not require individuals to block, isolate, or secure contents that may result in further harm to the occupants of the facility. Therefore procedures are not necessary for those who may need to operate critical plant operations during an evacuation.

Note: If there are operations that need to be taken care of during an evacuation that may create harm to the occupants of the facility and or to rescue personnel if not addressed immediately, procedures for those who are required to stay behind to address these issues need to be developed and inserted here.

D. Fire Emergency Procedures

1. Remove anyone in immediate danger.
2. Once an employee is alerted to the fire danger, he/she will go to the nearest exit,

activate the fire alarm (if present), exit the building according to the emergency action plan, and proceed directly to the designated assembly point.

3. Confine the fire to the room/area by closing the door to the area where the fire is located and by ensuring all doors leading to the main hallways are closed.
4. Attempt to extinguish the fire only if you have received training on the use of portable fire extinguishers, the fire is in its beginning stage, and it can be extinguished safely.
5. Disabled and non-ambulatory (unable to walk personnel) should request assistance from those nearest to them. Advise the fire department or security of personnel trapped who may require assistance to evacuate.

E. Earthquake Emergency Procedures

1. If you are indoors, stay there. Take shelter under a desk, table, or in a doorway. If you cannot get under something sturdy or stand in a doorway, get on your hands and knees and cover your head with your hands and arms.
2. If you are in a high-rise building, stay away from windows, outside walls, light fixtures, filing cabinets, and bookshelves. Do not attempt to use the elevators.
3. If you are outdoors, go to an open area away from trees, buildings, walls, roadways, and power lines.
4. If the building is evacuated, do not return until authorized.
5. Beware of potential dangers after an earthquake such as escaping gas, unstable building structures, electrical hazards, etc. Also beware of aftershocks.

F. Evacuation of the Disabled

A list of employees who will need assistance in the event of an emergency is included in attachment C. (Note: If in a single-story building, these procedures will need to be modified.)

1. Persons with a disability (including a short term disability) limiting them from using the stairs will congregate in the lobby area by the elevator where they will be assisted by either emergency responder or law enforcement personnel.
2. In the event an emergency renders the elevator lobby unsafe or dangerous, an emergency responder will assist or carry the disabled person down one or more floors for pick-up and relocation.
3. If assistance is not immediately available, disabled persons should stay in the exit corridor or at the top of the stairway or landing. An emergency responder will advise security and fire department personnel of the location of the disabled person(s) in the event all other actions fail.

G. Serious Injury

1. Check the scene and the victim to determine the danger potential and the extent of the injury. Do not move a seriously injured victim unless there is an immediate danger such as fire, flood, or poisonous gas. If you must move the victim, do it as

quickly and carefully as possible. If there is no immediate danger, do not move the victim and advise the bystanders the victim is not to be moved.

2. Call 9-1-1 immediately if the victim is unconscious. Additionally, you should call for an ambulance if the victim has trouble breathing or is breathing in a strange way; has pressure or pain in the chest or abdomen; is bleeding severely; has slurred speech; appears to have been poisoned; has injuries to the head, neck, or back; or has possible broken bones.
3. Keep the victim calm and as comfortable as possible. Administer CPR with the AED, if applicable, or First Aid if you have been trained in those areas (a list of these employees is included at the end of this document). A First Aid kit should be used and precautions should be taken to minimize exposure to blood and other bodily fluids. Remain with the victim until emergency service personnel and security arrive

H. Hazardous Materials

1. A hazardous material is a substance that presents a physical or health hazard. A health hazard refers to a substance for which there is significant evidence that health effects may occur for exposed employees.
2. A Safety Data Sheet (SDS) is required for all hazardous substances in use within the department. Employees will be provided with training on the safe use of all chemicals they will be exposed to.
3. In the event of a hazardous material emergency:
 - a. Evacuate the area, securing access to the area when possible.
 - b. Immediately call 911 (9-911 if in a County facility) and inform the operator of the emergency. Provide as much information as possible to the operator and refer to the MSDS.
 - c. If safe, remain in the immediate area and call law enforcement.
4. The list of chemicals regularly used in this facility are located [enter location of the list]. The SDS binder is located [enter location of the SDS binder].

I. Bomb Threats

1. If you receive a bomb threat or discover a possible bomb or suspicious object(s), follow the County's Bomb Threats and Suspicious Packages under regulatory compliance program No. 4, immediately notify your supervisor and call local law enforcement or 9-1-1, if appropriate. The supervisor shall immediately notify the department head of the situation.

Attachment A
Flow Chart of Building with AED, First Aid Kit, and Fire Extinguisher Locations

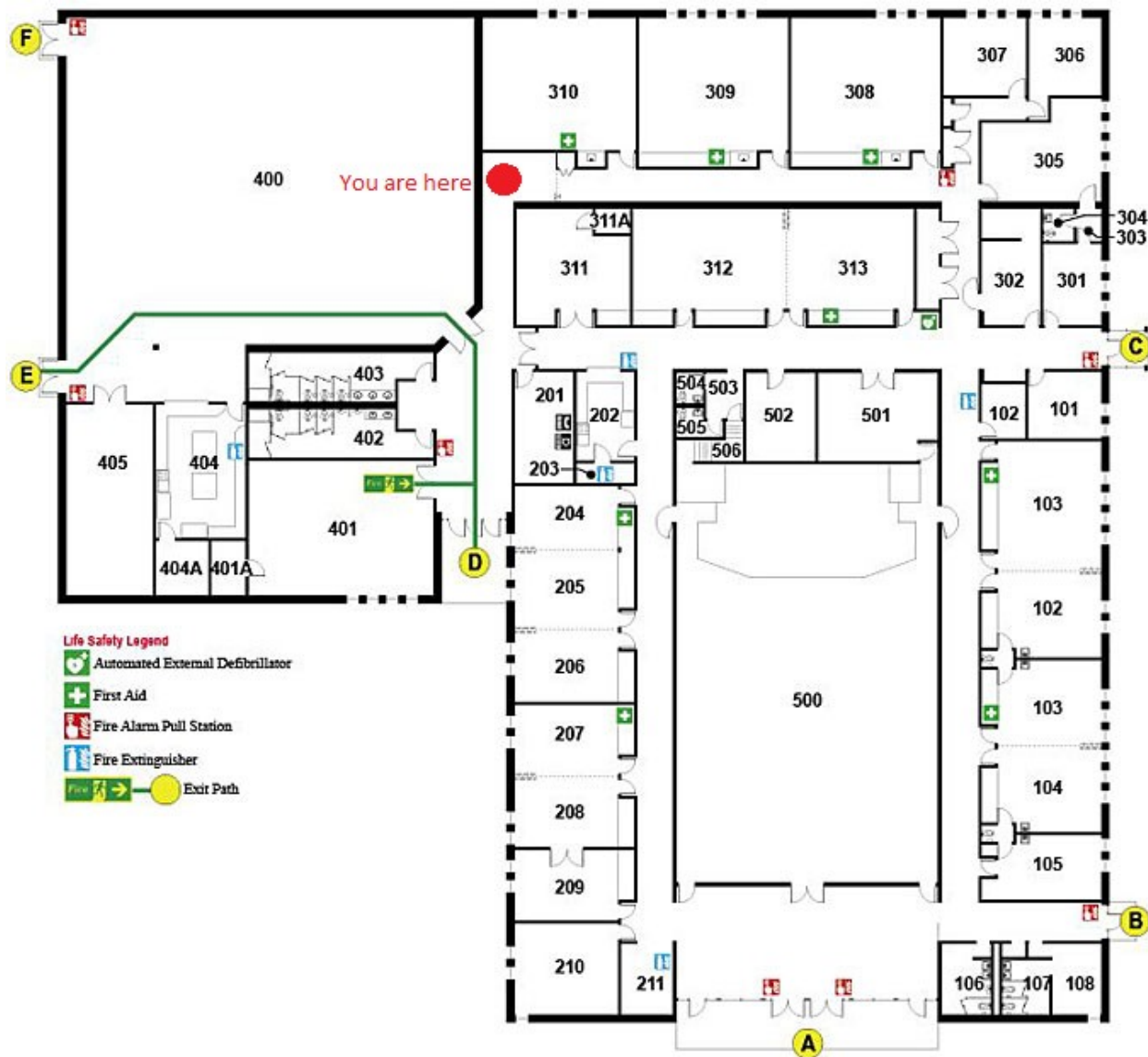

Note: Sample of an effective floor plan with designated escape routes. Delete and insert copies of your facilities escape routes. Directional arrows, locations of AEDS, First Aid kits, and fire extinguishers should be included. Also include the location of where the individuals are viewing the layout of the facility.



County of El Dorado, California

Regulatory Compliance Program No. 9 Ergonomics

I. Purpose and Scope

Ergonomics is the study of people and their interaction with the elements of their job or tasks, including equipment, tools, facilities, processes, and environment. Musculoskeletal disorders (MSD) develop when aspects of the work or workplace contribute to injury. MSDs are known by several other names including:

- CTDs (cumulative trauma disorders)
- RSIs (repetitive stress or repetitive strain injuries)
- RMI (repetitive motion injuries)
- Overuse syndrome

These injuries belong to a group of wear and tear illnesses that can affect muscles, nerves, tendons, ligaments, joints, cartilage, blood vessels, or spinal discs of the body. The purpose of an ergonomics program is to establish a system for the identification, evaluation, and control of ergonomic risk factors in the workplace. With a working system in place, the County can, over time, reduce the number and severity of MSDs, decreasing frequency and severity of workers' compensation claims, while increasing productivity, quality, and efficiency. This program is in compliance with Title 8, §5110, Repetitive Motion Injuries of the California Code of Regulations.

II. Responsibilities

A. The Human Resources Department - Risk Management Division (Risk Management) shall:

1. Manage the County-wide Ergonomics Program;
2. Provide initial and refresher ergonomic workstation evaluation training and certification to department safety coordinators (DSC), as needed;
3. Receive and review the Ergonomic Workstation Evaluation Request Form and the completed Ergonomic Assessment and Recommendation Report from DSCs;
4. Act as the approving authority for departments to purchase sit/stand workstations;
5. Review recommended ergonomic construction or remodeling plans; and
6. When needed, coordinate ergonomic consultations with approved vendors.

B. Department directors, managers, and supervisors shall:

1. Develop an awareness of basic ergonomics principles and communicate with employees about the program;
2. Ensure that employees are provided with and trained on the use of appropriate tools, equipment, and procedures for their job classification;
3. Confirm a system is in place for employees to report MSD signs or symptoms and suspected work-related risk factors;
4. Utilize workstation evaluations and safety inspections; and
5. Implement corrective measures to control MSD exposures.

C. DSC's shall:

1. Perform all respective department basic/initial workstation evaluations upon request;
2. Ensure that a system is in place for employees to report MSD signs or symptoms and suspected work-related risk factors;
3. Ensure that accurate records are maintained and provide documentation upon request;
4. Submit completed evaluation request forms and workstation evaluation reports to Risk Management; and
5. Follow up with each employee receiving an ergonomic evaluation and recommend further evaluation, if needed.

D. Employees shall:

1. Provide input and assistance with identifying ergonomic risk factors and workstation evaluations.
2. Complete equipment training and use appropriate tools, equipment, and procedures in a manner established by department management.
3. Complete ergonomics training, as required, and apply the knowledge and skills acquired.
4. Ensure that equipment is properly maintained, is in good working order, and report concerns immediately to a supervisor.
5. Report MSD signs or symptoms and work-related MSD hazards to a supervisor, manager, DSC, department head, or Risk Management.
6. Take responsibility for personal health and safety

III. Procedures

- A. An employee may request a workstation evaluation by completing and submitting the Ergonomic Workstation Evaluation Request Form and Supervisor Information Form (Attachment A) to the DSC. This form is available on the Risk Management intranet site.
- B. A workstation evaluation can also occur when:
 1. A new hire starts employment.
 2. An MSD sign or symptom is reported.
 3. Jobs, processes, or work activities, where work-related ergonomic risk factors have been identified, may cause or aggravate an MSD.
 4. Any change of job, task, equipment, tools, processes, scheduling, or changes in work shift hours.
 5. A safety walk-through, scheduled periodic inspection, or survey has uncovered potential MSD hazards.
- C. When an employee submits a workstation evaluation request to the DSC, the DSC shall

assign the employee the computer-based training “General Office Ergonomics” through Target Solutions. Upon completion of this course, the employee shall submit proof of completion to the DSC and make recommended adjustments to their workstation based on the training.

- D. The DSC will follow up after several weeks. If after this time where the workstation was in conformity with ergonomic standards and issues persist, the DSC will schedule an onsite ergonomic evaluation. The DSC shall address the following with the employee during the evaluation (this list is not exhaustive):
1. Basic body mechanics
 2. Principles of ergonomics
 3. Workflow, workstation organization, and physical setting
 4. Proper adjustment of furniture and computer accessories
 5. The use of the Micro Breaks application to facilitate making periodic physical adjustments

If the evaluation is outside the scope of County trained evaluators (i.e., medical conditions exist), the DSC shall contact Risk Management who will refer the employee to a qualified outside ergonomic consultant for evaluation.

- E. Once the DSC has completed the evaluation, they will submit the ergonomic request forms along with the completed Ergonomic Assessment and Recommendation Report to Risk Management. The report shall document background information, observations, training provided, risk factors, and recommendations.
- F. If the DSC recommends a sit/stand workstation for the employee, Risk Management will either approve of the request in writing or disapprove with alternatives to the sit/stand.
- G. A copy of the finalized report will be provided to the supervisor by the DSC. Upon review of the report, the supervisor will then decide whether they will implement the recommendations. If new equipment is recommended, the supervisor will purchase the equipment and work with the DSC to ensure proper installation. If workstation modifications are recommended, the supervisor will complete a work order through the Facilities staff.
- H. Each respective department is responsible for all costs resulting from ergonomic evaluations and the recommended equipment.

IV. Training Requirements

- A. Training is intended to enhance the ability of managers, supervisors, and employees to recognize work-related ergonomic risk factors and to understand and apply appropriate control strategies. Training in the recognition and control of ergonomic risk factors shall be provided as follows:
1. To all new employees during orientation;
 2. To all employees assuming a new job assignment;
 3. When new jobs, tasks, tools, equipment, machinery, workstations, or processes

are introduced; and

4. When high exposure levels to ergonomic risk factors have been identified.

B. All employees shall be provided training that includes an explanation of:

1. The County's Ergonomic Program;
2. Exposures which have been associated with MSDs;
3. The symptoms and consequences of injuries caused by repetitive motion; and
4. The importance of reporting symptoms and injuries to the County.

V. Program Evaluation

A. Risk Management will evaluate the Ergonomics Program annually in partnership with each DSC. Risk Management and the County-wide Safety Committee shall also conduct an annual program review to assess the progress and success of the program by utilizing:

1. Training records;
2. Completed Ergonomic Workstation Evaluation Requests and Reports;
3. Injury and illness records, including information on Company Nurse and Workers' Compensation claims; and
4. Employee feedback, observations, and/or re-evaluations.

Attachment A



EL DORADO COUNTY ERGONOMIC WORKSTATION EVALUATION REQUEST FORM

This form can be completed by an Employee, Department Management or department Safety Coordinator. A Department Manager or Supervisor signature is required before a workstation evaluation can be scheduled.

Name:		E-Mail:	
Work Phone:	Department:	Location:	
Date:		Supervisor:	

Is this related to a Workers' Compensation Claim? YES NO
If yes, date of injury: _____ Claim No.: _____

Reason(s) for Request (check all that apply):

Prevention New Employee New Equipment / Furnishings / Accessories Received
 Relocation/New Workstation Other - List Reason: _____
 Discomfort (List Specific areas and symptoms): _____

Previous evaluation done? YES NO
If YES: Date of prior evaluation: _____ Where: _____

Authorizer: _____ Title: _____
(please print)

Signature: _____ Date: _____
Phone: _____ E-mail: _____

Please submit to Risk Management

Risk Management Authorization: _____ Date Received: _____

Target Solutions Course Assigned – Date: _____ Proof of Completion – Date: _____
 Level 1 Eval Scheduled – Date: _____ Report Completed/Rec'd – Date: _____
 Risk Management Report sent to Supervisor/Manager – Date: _____
 Referred to Ergonomic Consultant Second Evaluation Scheduled – Date: _____
 Report Received – Date: _____ RM Report sent to Supervisor – Date: _____



EL DORADO COUNTY SUPERVISOR INFORMATION FORM FOR EMPLOYEE ERGONOMIC EVALUATION

The employee's supervisor or department manager must complete this form before Risk Management can schedule a workstation evaluation.

Employee Name:	Date:
Department:	Work Location:
Supervisor:	Supervisor Phone:

Please Complete the Following Job Information for your Employee:

Length of Employment with the County: _____

Flex Schedule? YES NO

Work Schedule:

Sun	Mon	Tue	Wed	Thurs	Fri	Sat

Job Duties: _____

Job Demands: _____

Work Flow: _____

Background Information: _____

Do you have any concerns about this employee? YES NO

If YES, please explain: _____

Report completed by: _____ Title: _____
(please print)

Signature: _____ Date: _____



County of El Dorado, California

Regulatory Compliance Program No. 10 Fire Prevention

I. Purpose and Scope

The County of El Dorado (County) Fire Prevention Program applies to all County employees and emphasizes fire prevention and safety. This is accomplished by maintaining compliance with applicable fire and life safety codes and standards, and through the establishment of good fire safety work habits. Refer to your facility's emergency action plan for more details on evacuation procedures.

II. Responsibilities

A. The Human Resources Department - Risk Management Division (Risk Management) will:

1. Facilitate hands-on training on the proper use of portable fire extinguishers and fire safety work practices; and
2. Provide expertise and assistance to County departments in the development of specific procedures and evacuation plans and to assist in evacuation drills as needed.

B. Departments:

1. In accordance with the County Illness and Injury Prevention Program, department directors will ensure that their employees are provided necessary training and maintain training documentation in fire prevention methods;
2. Department directors will enforce the County Fire Prevention Policy and procedures; and
3. Department directors will investigate and take appropriate action on all reported safety and health complaints.

C. Employees:

1. All employees will familiarize themselves with the policies and procedures related to fire protection and prevention.
2. All volunteers, staff, visitors, vendors, and contractors will abide by the County's Fire Prevention Policy.
3. Employees should report all safety concerns to their immediate supervisor and/or the DSC. If this is not possible, they should notify Risk Management at 530-621-5565.

III. Procedures

A. General Fire Safety Requirements

1. All stairwells (in and under), exits, and passageways to and from exits must be kept free of all obstructions at all times. This includes, but is not limited to, furnishings, decorations, combustible, or flammable objects.

2. Fire doors must be kept closed at all times unless they are held open by an approved device interconnected to the fire alarm system.
3. Flammable and combustible materials present in work areas should be limited to quantities required for the work to be done that day or should not exceed one gallon (total) except when in safety cans it may be up to two gallons(total). Any amount in excess one gallon in regular containers or the two gallons in safety cans must be placed in an NFPA Code 30 storage cabinet at the end of each workday.
4. Material must not obstruct sprinkler heads or be piled around fire extinguishers, fire alarm pull stations, or sprinkler and standpipe control valves. To obtain proper distribution of water, a minimum of 18 inches of clearance is required below sprinkler deflectors.
5. Dispose of all trash as soon as possible in trashcans or dumpsters. Waste materials must never be piled in corridors or stairwells while awaiting removal.
6. Electrical panels must not be blocked. They should have 18 inches of clearance on both sides and 36 inches in front of panel. A working space of not less than 30 inches in width, 36 inches in depth, and 78 inches in height must be provided in front of electrical service equipment. Where the electrical service equipment is wider than 30 inches, the working space must not be less than the width of the equipment. No storage of any materials shall be located within the designated working space.

B. Electrical Appliances

1. Coffee makers, toasters, toaster ovens, and all other appliances with exposed heating elements should never be left unattended while in operation. They should be unplugged after each use and stored only after they are cool enough to touch. Ensure that such appliances are operated away from combustible materials such as paper, curtains, trash containers, etc.
2. Appliances must bear the label of the Underwriters Laboratory (UL), Factory Mutual or other recognized national testing agency, indicating they are approved for safe operation.
3. Electrical appliances must never be connected to extension cords.
4. Employees should not modify or try to repair any electrical outlet.

C. Fire Identification, Notification, and Emergency Evacuation

1. Identification and Notification
 - a. In the event that anyone smells or sees smoke or fire, they must immediately activate the alarm to evacuate the building by using the nearest pull station or other means. Even if the fire is known to be small, the alarm must be activated immediately. All building occupants must be familiar with fire alarm pull station locations and/or evacuation procedures in their facility.

- b. After the alarm has been sounded and the fire has been reported to the fire department, an attempt should be made to extinguish or isolate the fire if it is small (no larger than a small trash can) and if it can be extinguished without risking injury. Portable fire extinguishers are available for use by trained staff.
- c. The building manager or designee should tell fire staff the exact location of the fire and other pertinent information.

2. Evacuation

- a. The primary concern in the event of a fire is to evacuate everyone from the building as quickly as possible when the fire alarm sounds. In order to accomplish this, occupants must be prepared in advance for quick and orderly evacuation. Annual training and drill will be conducted with all personnel to explain, in detail, evacuation procedures. All new employees must be trained when they start work.
- b. If time and conditions permit, close all doors and windows (do not lock doors, unless for security purposes). The floor or area manager is responsible for doing this, and may place post-its on the doors to indicate that the area is all clear per the facility emergency action plan.
- c. When on floors above ground level, always use stairways to exit the building - NEVER USE ELEVATORS.
- d. Once outside, stay clear of doors, sidewalks, and roadways. Immediately report to a designated meeting spot to check in with the safety coordinator or person taking roll call.
- e. Do not wander away from meeting area. This may cause confusion and result in firefighters entering a burning building to search for someone who has already evacuated the building.
- f. The fire department or Facilities staff will let building occupants know when it is safe to re-enter the facility.

3. Evacuation of Individuals with Disabilities

- a. If anyone is unable to make their way downstairs, they should obtain assistance from other individuals who are familiar with their disability. Pre-planning is essential.
- b. If no one is able to assist them down the stairs safely, proceed to the stairwell and inform other evacuees that immediate rescue is needed and to inform the fire department or building manager immediately. Someone should stay in the stairwell with this person. Stairwells are designed to provide protection from smoke and fire. Doors to these areas must be kept closed in order to afford this protection. Two people should be assigned to persons who are not able to exit the stairwell. One person will stay in the stairwell with the person requiring assistance and the other will report to the safety coordinator who and where the people are that are in the

stairwell. Employees should not try to assist others in going down the stairs, as this may result in serious injury and the endangerment of others. The fire department will assist those requiring assistance if they feel they are unsafe in the stairwell and need to be evacuated.

- c. While waiting, the people in the stairwell should position themselves so that their faces are as close to the floor as possible since smoke rises first and most of the available oxygen is near the floor. If smoke becomes too dense to breathe, place clothing or some other heavy cloth over their nose and mouth to filter as much smoke as possible until help arrives. If you enter a stairwell that has been compromised by smoke you should go to another stairwell. If you are unable to do so, you should go to an office or other safe area that is free of smoke and fire. Seal the room off as much as possible by sealing the area under the door, air vents, and any other areas that will allow for the passage of smoke. Contact the fire department (9-1-1) and inform them of where you are located.

4. Portable Fire Extinguishers

a. Selection and Location

Fire Code mandates a commercial facility to have extinguishers every 75 feet. Portable fire extinguishers are also selected and placed based on hazard classification, occupancy, and the nature of the materials subject to fire. Most fire extinguishers at the County are all-purpose ABC extinguishers.

b. Types

Fires are classified into groups according to the nature of the material subject to fire. Fire extinguisher classification corresponds to these groups:

Class A	fires consisting of ordinary combustibles, such as wood, paper, some plastics, and textiles, where a quenching and cooling action of the extinguishing agent is required
Class B	fires consisting of flammable liquid and gas, such as oil, gasoline, paint, acetone, or grease, where oxygen exclusion or a flame-interrupting effect of the extinguishing agent is required
Class C	fires involving electrical wiring and electrical equipment where dielectric non-conductivity of the extinguishing agent is required
Class D	fires consisting of combustible metals, such as magnesium, potassium, powdered aluminum, zinc, sodium, titanium, zirconium, and lithium, where a material specific extinguishing agent is required

c. Inspections are as follows:

- Monthly - all fire extinguishers are inspected by a private contractor on a monthly basis.
- Annual - all County fire extinguishers have a set inspection date, which requires that a certified service provider inspect and/or service them annually. This task is also performed by the private contractor. In the event monthly and annual inspections are not being completed, contact the Facilities Department.

- d. Fire Extinguisher Use - if a fire extinguisher is used for any reason, it must be reported to Facilities management so it can be replaced with a charged extinguisher. It is recommended to notify the fire department after using the fire extinguisher to have them verify the fire is completely extinguished.

D. Holiday Fire Safety Guidelines

These fire safety guidelines must be use when decorating for holidays or special occasions:

1. All decorations, such as garland, artificial trees, wreaths, tinsel, and streamers must be labeled as "fire-proof," "fire-resistant" or "flame-proof." All holiday lighting should bear a testing laboratory seal of approval.
2. Never use lights on metallic trees.
3. Natural trees, wreaths, and greens are prohibited in public buildings.
4. The use of lit candles is prohibited in all buildings.
5. Holiday lights must not be left unattended.
6. Decorations must be arranged in a manner not to obstruct exits, emergency lighting, exit signs, corridors, fire extinguishers, manual pull stations, or any other fire equipment.
7. Straw, hay, corn stalks, dried flowers, or bamboo and other similar combustibles are prohibited as decorations inside facilities.
8. Helium balloons may be prohibited in some facilities where they may trigger the fire alarm system. Consult with Facilities before using helium balloons.

IV. Program Evaluation

Risk Management will evaluate and update the Fire Prevention Program annually in partnership with DSC's.



County of El Dorado, California

Regulatory Compliance Program No. 11 Hearing Conservation

I. Purpose and Scope

The objective of this Hearing Conservation Program (HCP) is to prevent noise-induced hearing loss resulting from on-the-job noise exposure. To assure compliance with the California Code of Regulations, Title 8, Sections 5095-5100 (8CCR5095-5100), this regulatory compliance program provides guidance to managers and staff on the County's HCP, which applies to all employees who are determined to be at or to exceed the action level established in 8CCR5095. Attachment A lists definitions of the terms used in the HCP.

II. Responsibilities

A. The Human Resources Department - Risk Management Division (Risk Management) will:

1. Study specific operations, facilities, and equipment to determine employee noise level exposures;
2. Help managers and supervisors determine which employees must participate in the HCP. Employees whose noise exposures equal to or exceeding the action level of 85 dBA TWA or higher are included in the HCP;
3. Schedule and oversee annual audiometric examinations; and
4. Maintain all records of noise studies and audiometric examinations.

B. Department Directors will:

1. Implement the HCP throughout their departments;
2. Request help from Risk Management staff to study specific operations, facilities, and equipment to determine employee noise level exposures as needed;
3. Whenever practical, use engineering and/or administrative controls to reduce the noise exposure to employees to at or below 85 A-weighted decibels time-weighted average (85 dBA TWA). Engineering controls may include purchasing quieter equipment, installing noise-reducing baffles, and placing rubber mats under machinery while administrative controls may include restricting employee exposure time;
4. Issue appropriate hearing protection devices (HPDs) to employees in areas or operations which have been determined to have noise levels at or above 85 dBA;
5. Ensure that employees exposed to noise at or above 85 dBA action level participate in annual audiometric examinations (i.e., baseline and annual);
6. Conduct frequent checks and strictly enforce the proper use of HPDs by employees; and
7. Conduct documented annual hearing conservation training for employees to include both general information as well as job specific components.

C. Employees will:

1. Properly and consistently wear and care for their HPDs;

1. Participate in annual audiometric testing; and
2. Participate in annual HCP training.

III. Procedures

A. Noise Monitoring

Noise level monitoring will be considered whenever employees have the following:

1. Difficulty communicating by speech while in the noise area and the listener and speaker face each other at a distance of two feet;
2. Complaints such as headaches and/or ringing in the ears after working in a noise area for extended periods; or
3. Temporary loss of hearing that has the effect of muffling speech and other sounds after extended exposure to the noise.

Managers and supervisors will determine if any employee is exposed to a daily dose greater than the action limit of 85 dBA by utilizing Risk Management staff or qualified contractors to make the determination. If routine or periodic survey monitoring identifies an employee for inclusion in the HCP, additional monitoring may be conducted to obtain measurements of other employees who may be similarly exposed.

B. Hearing Protection Devices

1. Employees who are required to wear HPDs will be given an opportunity to select from a variety of suitable types (e.g., earplugs or earmuffs). Procedures established and implemented by the department will ensure proper issuance, cleaning, maintenance, and training in the use of HPDs.
2. HPDs issued to employees will provide an adequate degree of protection to reduce noise exposure below prescribed limits. Each employee receiving a pair of earplugs for reduction of exposure will be fitted by an individual trained in the proper selection and use of earplugs.
3. HPDs are required to be worn if it is determined that a standard threshold shift has occurred as evidenced by audiometric testing or if the eight-hour TWA is at or above 90 dBA.

C. Audiometric Testing

All employees identified by monitoring for inclusion in the HCP will participate in preliminary (baseline) and subsequent (annual) audiometric tests. The preliminary audiometric test will be administered at their pre-employment physical examination.

D. Recordkeeping

Risk Management has access to the following records:

1. Noise exposure measurements;
2. Audiometric test results including audiograms, name, and classification of employees, date of audiogram, the name of the examiner, date of audiometer calibration, and date of employee's last assessment; and

3. Background noise levels in audiometric test facilities.

E. Access to Records:

Records will be provided upon written request by employees, former employees, or representatives designated by individual employees.

F. Training:

Employees will be informed of hazardous areas through appropriate signage and instructions. Hearing protection will not be issued to an employee until proper use and maintenance procedures have been demonstrated to the employee by the supervisor or qualified designee. Audio-visual training aids, written materials, handouts, and online training is available from Risk Management. Departments will provide annual training for employees in the HCP and will include the following components:

1. Discussion of the effects of noise on hearing;
2. Purpose of hearing protection;
3. Use and care of HPDs;
4. Advantages and disadvantages of different HPD; and
5. Purpose and explanation of audiometric testing.

IV. Program Evaluation

Risk Management will evaluate and update the Hearing Conservation Program annually in partnership with DSC's.

Attachment A Definitions

Action Level

An eight-hour weighted average of 85 decibels measured on the A-scale, slow response, or equivalently, a dose of 50 percent.

Attenuate

Reduce the amount of noise.

Audiogram

A chart, graph or table resulting from an audiometric test showing an individual's hearing threshold levels as a function of frequency (from 500 to 6000 Hertz).

Baseline Audiogram

The audiogram against which future audiograms are compared.

Decibel (dB)

A non-dimensional unit used to express noise levels; a logarithmic expression of the ratio of a measured quantity to reference quantity.

Decibel A-weighted (dBA)

Decibels measured on the A-weighted scale, slow response.

Hearing Protection Devices (HPDs)

A device inserted into or placed over the ear for the purpose of reducing air-conducted sounds.

Hertz (Hz)

Unit of frequency measurement, numerically equal to cycles per second.

Noise

Disturbing, harmful or unwanted sound.

Noise-induced Hearing Loss

Refers to the slowly progressive inner ear hearing loss that results from exposure to continuous noise over a long period of time as contrasted to acoustic trauma or physical injury to the ear.

Permissible Exposure Limit for Noise

90 dBA for eight hours.

Recordable Standard Threshold Shift

A standard threshold shift of 25 dB or greater in either each which is recorded on the OSHA 300 log for that year.

Standard Threshold Shift (STS)

A change in hearing threshold relative to the baseline audiogram of an average of 10 dB or more at 2000, 3000 and 4000 Hz in either ear.

Time-weighted Average Sound Level (TWA)

That sound level, which if measured over an eight-hour exposure would result in the same noise dose as is measured.



County of El Dorado, California

Regulatory Compliance Program No. 12 Heat Illness Prevention

I. Purpose and Scope

This regulatory compliance program (RCP) establishes the County of El Dorado's (County) Heat Illness Prevention Program to control the risk of the occurrence of heat illness in accordance with California Code of Regulations (CCR) Title 8 Section 3395. This RCP applies to all County employees who work outdoors.

II. Responsibilities

Each department with workers covered by this RCP is responsible for the following:

A. Assessing Environmental and Personal Risk Factors

1. The environmental risk factors for heat illnesses are highly likely to be present from the beginning of April through the end of October. Actual weather conditions (e.g., heat index, weather forecast, etc.) should also be taken into consideration to determine the actual risk for each work day.
2. Working conditions, the type of work, workload intensity and duration, and the use of personal protective equipment (PPE) are additional factors that must be considered when departments assess the risk for heat illness.
3. Personal risk factors and the degree of acclimatization should also be considered when determining the tasks for employees each day.

B. Providing Drinking Water

1. Departments must provide sufficient quantities of drinking water in any work environment and supervisors must encourage employees to drink water frequently.
2. A minimum of one quart of drinking water per hour must be available to each employee or two gallons per employee for an eight-hour shift, to replace water lost by perspiration.
3. Water must be potable, fresh, pure, and suitably cool.

C. Access to Shade (shade-up provisions)

1. Shade (blockage of direct sunlight) must be provided by temporary structures if adequate shade cannot be provided by buildings or trees.
2. Vehicle interiors or structures such as sheds are not permissible unless they are air-conditioned or can provide a cooling environment comparable to shade in open air.
3. Employees shall be allowed and encouraged to take a cool-down rest in the shade for a period of no less than five minutes at a time when they feel the need for protection from overheating. Such access to shade shall be permitted at all times.
4. When the temperature exceeds 85 degrees Fahrenheit, shade is required to be present and sufficient to accommodate 25% of the employees on the shift at a time, in a normal, seated posture, without physical contact with each other.
5. When the temperature does not exceed 85 degrees Fahrenheit, shade is required to

be available. (Shade must be present, or timely access to shade must be provided upon an employee's request).

- D. High-heat procedures take effect when the temperature equals or exceeds 95 degrees Fahrenheit. The procedures apply only to County operations that encompass agriculture, construction, landscaping, or transportation of heavy materials in vehicles not equipped with air-conditioning. The procedures require supervisors to:
1. Ensure that effective communication is maintained by voice, observation, or electronic means;
 2. Observe employees for alertness and signs or symptoms of heat illness;
 3. Remind employees throughout the work shift to drink plenty of water; and
 4. Closely supervise new employees for the first 14 days of employment.

III. Training

- A. Effective training must be provided to all employees and their supervisors before beginning work that should be reasonably anticipated to result in exposure to the risk of heat illness. Training must include the following information:
1. The environmental and personal risk factors for heat illness, as well as the added burden of heat load on the body caused by exertion, clothing, and personal protective equipment;
 2. The department/division's procedures for identifying, evaluating, and controlling exposures to environmental and personal risk factors for heat illness;
 3. The importance of frequent consumption of small quantities of water (access to water and drinking vessels or containers to be supplied). Note: Extreme conditions, high heat, high humidity, or heavy work load, may necessitate drinking up to four cups of water per hour to prevent heat illness;
 4. The importance of acclimatization or adapting gradually to the heat;
 5. The different types of heat illness as well as the common signs and symptoms;
 6. The importance of employees immediately reporting to the department/division, directly or through the supervisor, symptoms or signs of heat illness in themselves, or in co-workers;
 7. The department/division's procedures for responding to symptoms of possible heat illness, including how emergency medical services will be provided should they become necessary;
 8. Procedures for contacting emergency medical services (9-1-1), and, if necessary, for transporting employees to a point where they can be reached by an emergency medical service provider; and
 9. How to provide clear and precise directions to the work site.
- B. Supervisors must be trained prior to supervising employees performing work that should reasonably be anticipated to result in exposure to the risk of heat illness. Initial and annual training for supervisors of employees covered by this RCP must include the

following information:

1. The information required to be provided to all employees as listed in Sections B and C above.
2. The procedures the supervisor is to follow to implement the applicable provisions of CCR Title 8 Section 3395. The standard requires five simple provisions: 1) provide timely access to shade when the temperature does not exceed 85 degrees Fahrenheit, and ensure shade is present when the temperatures exceeds 85 degrees Fahrenheit; 2) provide adequate water, up to one quart per hour per employee; 3) When the temperature equals or exceeds 95 degrees Fahrenheit, and if employees are engaged in agriculture, construction landscaping, or non-air conditioned transportation of heavy items, then follow special "high-heat" provisions; 4) provide effective training; and 5) provide written procedures such as this RCP.
3. The procedures the supervisor is to follow when an employee exhibits symptoms consistent with possible heat illness, including appropriate emergency response procedures. Refer to Attachment B for more information.
4. Account for all employees during and at the end of the work shift.
5. If the temperatures are high, consider beginning and ending work shifts early.
6. If possible, work should be performed in the shade.
7. Consider scheduling heavier work early in the day.
8. Contact 911 if unsure of an employee's symptoms.
9. If an employee shows signs of serious heat illness at the end of the work shift, supervisors should ensure the employee gets medical attention before going home.
10. Immediately report to the Human Resources Department - Risk Management Division (Risk Management) at 621-5565 and to the Workers' Compensation Office at 621-5618 if an employee experiences loss of consciousness for any reason or must be hospitalized. After hours, please contact Risk Management by emailing riskmanagement@edcgov.us.
11. Monitor weather reports by 5:00 PM the day before to determine whether temperature will be a factor in the next day's activities. Understand how to respond to hot weather advisories.

IV. Program Evaluation

Risk Management will evaluate and update the Heat Illness Prevention RCP annually in partnership with department safety coordinators.

Attachment A Definitions

Acclimatization

Temporary adaptation of the body to work in the heat that occurs gradually when a person is exposed to it. Acclimatization peaks in most people within four to fourteen days of regular work for at least two hours per day in the heat.

Environmental Risk Factors for Heat Illness

Working conditions that create a setting in which heat illness could occur, including air temperature, relative humidity, radiant heat from the sun and other sources, conductive heat sources such as the ground, air movement, workload severity and duration, protective clothing and personal protective equipment worn by employees.

Heat Cramps

Painful, involuntary muscle spasms that usually occur during heavy exercise or strenuous activity in hot environments. Inadequate fluid intake often contributes to heat cramps. Spasms may be more intense and more prolonged than typical nighttime leg cramps. Muscles most often affected include calf, arm, abdomen, and back, although heat cramps may involve any muscle group involved in the activity.

Heat Exhaustion

A form of heat illness which can develop after several days of exposure to high temperatures and/or inadequate or unbalanced replacement of fluids. Those most prone to heat exhaustion are the elderly, those with high blood pressure, and those working or exercising in a hot environment. Untreated, heat-exhaustion may lead to heat stroke. Symptoms include cool, moist, pale, flushed or red skin; heavy sweating; headache; nausea or vomiting; dizziness; giddiness; and extreme weakness or fatigue. The skin is clammy and moist while the body temperature can be near normal or slightly elevated, not exceeding 104 degrees Fahrenheit.

Heat Illness

A serious medical condition resulting from the body's inability to cope with a particular heat load. Heat illness includes, in increasing severity, heat cramps, heat exhaustion, heat syncope, and heat stroke.

Heat Index

An index that combines air temperature and relative humidity to determine an apparent temperature, or how hot it feels. High humidity reduces the body's ability to get rid of excess heat via perspiration, so for a given air temperature, the higher the humidity, the higher the apparent

temperature or heat index.

Heat Stroke

A serious heat illness requiring immediate first aid and medical attention (911). Heat stroke occurs when the body is unable to lower its temperature because the biological cooling mechanism has shut down. Symptoms include sweating has stopped; confusion; irrational behavior; loss of consciousness; convulsions; (usually) hot dry skin; and body temperature may reach 105 degrees Fahrenheit or higher which may lead to death.

Heat Syncope

Sudden fainting or loss of consciousness related to heat caused by low blood pressure. Heat causes blood vessels in the skin and in the lower part of the body to dilate, which may cause the blood to pool in the lower extremities rather than return to the heart to be pumped to the brain, which may then result in fainting.

High-heat Procedures

Procedures implemented when the temperature equals or exceeds 95 degrees Fahrenheit. The procedures apply only to County operations that encompass agriculture, construction, landscaping, or transportation of heavy materials in vehicles not equipped with air-conditioning. The procedures require effective communication with supervisors, observation of employees, reminding employees to drink plenty of water, and close supervision of new employees for the first fourteen days.

Personal Risk Factors

Factors such as an individual's age, degree of acclimatization, overall health, water consumption, alcohol consumption, caffeine consumption, and use of prescription medications which affect the body's water retention or other physiological responses to the heat.

Preventative Recovery Period

A period of time used to recover from the heat in order to prevent heat illness. This could be in addition to or the same as a normal rest break.

Provision of Water

Employees must have access to potable drinking water. Where water is not plumbed or otherwise continuously supplied, it shall be provided in sufficient quantity at the beginning of the work shift to provide one quart per employee per hour for drinking during the entire shift. Employers may begin the shift with smaller quantities of water if they have effective procedures for replenishment during the shift as needed to allow employees to drink one quart or more per hour. The frequent drinking of water shall be encouraged.

Shade

The blockage of direct sunlight. Trees, dense vines, canopies, umbrellas, vehicles with the air conditioning running, and other temporary structures or devices may be used to provide shade. One indicator that blockage is sufficient is when objects do not cast a shadow in the area of blocked sunlight. Flecks of sunlight are acceptable. Shade is not adequate when heat in the area of shade defeats the purpose of shade, which is to allow the body to cool.

Shade access

Access to shade is required to be permitted at all times. Employees suffering from heat illness, or believing a preventative recovery period is needed, should be allowed and encouraged to take a cool-down rest in the shade for a period of no less than five minutes. Cooling measures other than shade (e.g., use of misting machines) may be provided if the department can demonstrate that these measures are at least as effective as shade in allowing the employees to cool and if it is infeasible or unsafe to have a shade structure.

Shade-up provisions

When the temperature exceeds 85 degrees Fahrenheit the 2010 “shade-up” amendments of §3395 take effect, and shade must be present in a sufficient amount to allow 25% of the employees on the shift at any time to sit in a normal posture without physical contact with each other. The shade shall be as close as practicable to the areas where the employees are working. When the temperature does not exceed 85 degrees Fahrenheit, shade is required to be available, meaning either present, as described above, or provided in a timely manner upon an employee’s request.

Attachment B
Causes, Signs and Symptoms of Heat Illness

The following is a summary of the causes, signs, and symptoms as well as treatment of the types of common heat illnesses.

- A. Heat cramps are caused by strenuous activity in the heat. People who perspire more than average during strenuous activity are more prone to heat cramps. The perspiration depletes the body's salt and moisture. The low salt level in the muscles causes painful cramps. Heat cramps may also be a symptom of heat exhaustion. If you suspect heat cramps:
- Have the employee stop all activity and sit quietly in a cool place;
 - Have the employee rest briefly and cool down;
 - Make sure the employee drinks cool water (not iced), clear juice, or a sports beverage containing electrolytes;
 - Practice gentle, range-of-motion stretching and gentle massage of the employee's affected muscle group;
 - Be aware that returning to strenuous activity after the cramps subside may lead to heat exhaustion or heat stroke; and
 - If symptoms do not go away in one hour, seek medical attention.
- B. Heat exhaustion is caused by excessive heat and dehydration. The warning signs of heat exhaustion include: heavy perspiring, paleness, muscle cramps, tiredness, weakness, dizziness, headache, nausea or vomiting, and fainting. Symptoms of heat exhaustion may be cool and moist skin, pulse rate will be fast and weak, and breathing will be fast and shallow. If heat exhaustion is untreated, it may progress to heat stroke. If you suspect heat exhaustion:
- Get the employee out of the sun and into a shady or air-conditioned location;
 - Lay the employee down and elevate the legs and feet slightly;
 - Loosen or remove the employee's clothing;
 - Have the person drink cool water (not iced), clear juice or a sports beverage containing electrolytes;
 - Cool the employee by spraying or sponging him/her with cool water and fanning.
 - Ice packs may be applied under the arms and in the groin area; and
 - Seek medical attention.
- C. Heat syncope (or fainting) is caused by strenuous activity in hot environments and dehydration. Heat syncope can be caused by blood pooling in the legs if a person has been standing still for a long time in a hot environment. It can also be caused by vigorous physical activity for two or more hours before the fainting happens. The risk of developing heat syncope increases when a person has not acclimated to a hot environment. The warning signs for heat syncope include: pale, cool, and moist skin, feeling faint or lightheaded, lightheadedness when a person changes position, such as moving from a lying position to a standing position, and being dehydrated. If

you suspect heat syncope:

- Get the employee out of the sun and into a shady or air-conditioned location;
- Lay the employee down and elevate the legs and feet slightly;
- Have the employee drink cool water (not iced), clear juice, or a sports beverage containing electrolytes;
- Cool the employee by spraying or sponging victim with cool water and fanning;
- Ice packs may be applied under the arms and in the groin area; and
- If symptoms do not go away in one hour, seek medical attention.

D. Heat Stroke is caused when the body's mechanism for dealing with heat stress, such as perspiring and temperature control, are lost. The main sign of heat stroke is elevated body temperature, generally greater than 104 °F. The warning signs of heat stroke include: red, hot, and dry skin, rapid heartbeat, rapid and shallow breathing, elevated or lowered blood pressure, cessation of sweating, irritability, confusion, unconsciousness, and fainting. If you suspect heat stroke:

- Move the employee out of the sun and into a shady or air-conditioned space;
- Dial 911 for emergency medical assistance;
- Cool the employee by covering him/her with damp sheets or by spraying with cool water and fanning; and
- Ice packs may be applied under the arms and in the groin area.

If an employee experiences loss of consciousness for any reason or will be hospitalized, immediately report this to Risk Management at 530-621-5565 and to the Workers' Compensation Office at 530-621-5618. After hours, please email Risk Management at riskmanagement@edcgov.us.



County of El Dorado, California

Regulatory Compliance Program No. 13 Hazard Communication

I. Purpose

To establish a regulatory compliance program (RCP) whereby the County of El Dorado (County) employees are provided with information about the hazardous substances to which they may be exposed at work. This includes container labeling and other forms of warning, material safety data sheets, and employee training. This RCP meets the requirements of Title 8, California Code of Regulations, Section 5194.

II. Procedures and Requirements

A. Hazardous Substance Inventory

1. Each department head will ensure there is an annual dated inventory of all hazardous substances present in their workplace(s). These substances will be identified by the common name referenced on the appropriate Safety Data Sheet (SDS). Attachment A is a list of definitions for terms used in this regulatory compliance program and more information on SDSs can be obtained from the Facilities Department.
2. The hazardous substance inventory is to remain current and all future products must be included at or before the time of use.
3. In areas where there are multi-department employees or where County employees work with outside contractors, a pre-work conference will be held to discuss the hazardous substances to be used.
4. An annual dated inventory shall be kept and archived to prove when products were in use. Current inventories will be kept with the SDS. Attachment B is an example of a chemical inventory.

B. Labels and Other Forms of Warning

1. Each department head will ensure that each container of hazardous substance in the workplace is labeled, tagged, or marked with the following information:
 - a. The common name of the hazardous substance;
 - b. The appropriate hazard warnings; and
 - c. Any other appropriate hazard warning.

Employees must not remove or deface any of the manufacturer's labels or warnings.

2. Secondary containers will be labeled with the common name of the hazardous substance and the proper National Fire Protection Agency (NFPA) warning label or equivalent.

C. Safety Data Sheets

1. Each department director will ensure that divisions will obtain SDSs for each hazardous substance on their inventory list. SDSs must be available in a central location, which is easily accessible to all employees during work hours. Remote locations which use or store hazardous substances should have SDSs available on site, but the main office SDS

will suffice if information is immediately available by phone.

2. Employees are required to follow instructions and precautions of the SDS, unless otherwise directed in a tailgate meeting or by the Safety Office.
3. If the SDS is not provided by the manufacturer, the department head shall do the following:
 - a. Send a written request to the manufacturer within seven (7) working days from the date of the employee request,
 - b. Provide a copy of the written request to the employee requesting the SDS,
 - c. Notify the employee within fifteen (15) days of the receipt of the SDS, and
 - d. Notify the Director of the State Department of Industrial Relations if a response has not been received from the manufacturer within twenty-five (25) working days from the date of the request.

D. Contract Work

When it is necessary for an outside contractor to perform work for the County, it shall be the responsibility of the project manager to inform the contractor of the identity of any hazardous chemicals to which the contractor's employees must be exposed. The project manager will obtain a signed receipt of having provided this information at the pre-job conference. The procedure for informing the contractor will include the following:

1. Making the hazardous chemical inventory of any designated work area where contract work is being performed available to the contractor and advises the contractor of the labeling system.
2. Making the SDSs of the identified hazardous chemicals in a designated work area available to the contractor.
3. Making the contractor aware of the appropriate protective measures taken by employees in a designated work area.

It is also the responsibility of the project manager to determine if the contractor will be using any hazardous chemicals and, if so, to take appropriate actions to assure the protection of the County's employees.

E. Hazardous Non-Routine Tasks

Prior to starting work on hazardous non-routine tasks, every affected employee will be given information by the supervisor about the hazardous chemical(s) to which they may be exposed. Such information will include, but not limited to, specific hazards associated with the chemical(s), protective measure (e.g., personal protective equipment, work practices, engineering controls etc.) and emergency procedures.

III. Training

The department head will ensure that employees are provided with information and training on hazardous substances in their work area at the time of their initial assignment, whenever a process changes, and whenever a new hazard is introduced into their work area. The information and training will consist of the following:

1. An overview of the California Occupational Health and Safety Administration (Cal/OSHA) regulation;
2. The requirements of this RCP;
3. The operations in the work area where hazardous substances are present;
4. The location and availability of this written program, the inventory of hazardous materials and the SDSs;
5. The methods and observations that may be used to detect the presence or release of a hazardous substance in the work area;
6. The physical and health hazards of the substances in the work area and the necessary protective measures that must be implemented;
7. An explanation of the labeling system and the SDS, and how the employees can obtain and use the appropriate hazard information;
8. How to reduce or prevent exposure to hazardous substances through the use of engineering controls, work practices, and/or through the use of personal protective equipment;
9. Steps the County has taken to reduce or prevent exposure; and
10. Emergency and first aid procedures.

The employees have the right:

1. To personally receive information regarding hazardous substances to which they may be exposed;
2. For their physician or collective bargaining agent to receive information regarding the hazardous substances to which the employee may be exposed; and
3. Against discharge or discrimination due to the exercise of these rights.

The department head will ensure that employees are initially trained in the elements of this RCP. The chemical hazards will be discussed in the regular periodic tailgate meetings prior to the use of the hazardous substances.

All initial and subsequent training will be documented on the proper forms found in the County's Injury and Illness Prevention Program. The documentation will include a brief description of the training, date, name, and signature.

IV. Program Evaluation

The Human Resources Department - Risk Management Division will evaluate and update the Hazard Communication RCP annually in partnership with department safety coordinators.

Attachment A Definitions

Common Name

Any designation or identification such as code name, code number trade name, brand name or generic name used to identify a substance other than by its chemical name.

Container

Any bag, barrel, bottle, box, can, cylinder, drum, reaction vessel, storage tank, tank truck, or the like that contains a hazardous substance. For purposes of this program, pipes or piping systems are not considered to be containers.

Exposure or Exposed

Any situation arising from work operation where an employee may ingest, inhale, absorb through the skin or eyes, or otherwise come into contact with a hazardous substance.

Hazard Warning

Any words, pictures, symbols, or combination thereof appearing on a label or other appropriate form of warning which convey the health hazards and physical hazards of a substance in the container.

Hazardous Substances

Any substance with a potential to cause a physical or health hazard.

Health Hazard

Any substance in which acute or chronic health effects may occur in the exposed employees. These include substances, which are carcinogens, reproductive toxins, irritants, corrosives, and sensitizers.

Identity

The common or chemical name indicated on the Material Safety Data Sheet (SDS) for the substance.

Label

Any written, printed, or graphic material displayed on or affixed to containers of hazardous substances.

Material Safety Data Sheet (SDS)

Written or printed material provided by the manufacturer concerning a hazardous substance.

NFPA

The National Fire Protection Association.

Secondary Container

Any container other than the one produced by the manufacturer.

Attachment B
Example of a Chemical Inventory

Chemical Name	Manufacturer	Amount	Comments
33 glazing	DAP	1 X 32 fl. oz.	
3M electrical 4-way	3M Electronic Products	1 X 10.75 oz. aerosol	part no. 1605
3M scotch grip 1357	3M Ind. Tape and Spec.	1 X 32 fl. oz.	adhesive; part no. 62-1357-6530-3
acetylene (dissolved) cylinders	Sierra Airgas	4 X 125 cf cylinders	
acetylene cylinders	Sierra Airgas	4 X 7 cf; 5 X 125 cf	(916)454-9353
acrylastic 510	Davlin Coatings	1 X 5 gal.	prop 65
Aerokroil	Kano Labs.	2 X 10 oz. aerosol	(615)833-4101
airco nozzle dip	Airco	1 X 16 fl. oz.	part no. 0-108-16
allo cutting lubricant	Pathlord, Ltd.	1 X 500 g	
ammonia inhalants	Zee Medical	1 package	part no. 2601
argon cylinder	Sierra Airgas	1 X 250 cf cylinder	
argon/CO2 cylinder	Sierra Airgas	1 X 250 cf cylinder	
bacharach fyrite solution (red for CO2)	Bacharach	1 X 2 oz.	(412)963-2000
basalite concrete mix	Union Camp Corporation	3 X 80 pounds	
betco pH 7 neutral cleaner	Betco	1 X 1 gal.	
bleach (All Pure Chemical brand)	All Pure Chemical	1 X 1 gal.	
bleach (Lucky brand)	Nat'l Procurement and Logistics	1 X 1 gal.	5.25% sodium hypochlorite
boraxo TMT	Dial	2 X 5 pounds	part no. 2561
bostik never seez	Bostik	1 X 8 oz.	(580)777-0100
bostik RTV silicone sealant	Bostik	6 X 10.3 fl. oz.	used throughout
brake kleener	Curtis Industries	1 X 19.75 oz. aerosol	part no. 83997
brazo welding/brazing flux	All-State Welding Products	1 X 1 pound	(800)638-1647
butyl rubber caulk	Sherwin-Williams	4 X 10.5 fl. oz.	
calgon c-3 refrigeration oil	Calgon	1 X 1 gal.	part no. 43031
calgon c-4 refrigeration oil	Calgon	2 X 1 gal.	part no. 43041
chemsearch gex (lubricant)	Chemsearch	1 X 14 oz. aerosol	(800)527-9921; flammable
chemsearch hy-zinc	Chemsearch	9 X 16 oz. aerosol	(800)527-9921
citrachief cleaner	Apache Enterprises	1 X 1 gal.	alkaline; (916)422-1118
CO (90.8 ppm) balance nitrogen cylinder	Sierra Airgas	1 X 250 cf cylinder	
coil rite	Stewart Hall	1 X 1 gal.	non-acid cleaner



County of El Dorado, California

Regulatory Compliance Program No. 14 Hot Work

I. Purpose

This document establishes the Hot Work Operations regulatory compliance program (RCP) for all employees of the County of El Dorado (County) as per CCR Title 8 Section 4848. The purpose of this program is to protect employees from injury and County buildings from damage associated with hot work. All hot work must be accomplished in accordance with this written RCP; the County's safe work practices for hot work; and the manufacturers' recommended safety precautions for the equipment used in welding, cutting, grinding, or brazing processes.

II. Procedures and Requirements

Each department/division with workers covered by this RCP is responsible for the following:

A. Training and Authorization

- a. No employee will be allowed to perform hot work operations unless he/she has been trained and authorized to do so.
- b. All training must be documented.

B. Approved Equipment

Only approved equipment (e.g., torches, manifolds, regulators, valves, etc.) may be used. Approved equipment is defined as unmodified equipment as received from the manufacturer and used as intended and designed.

C. Hot Work Permits

Hot work may be performed without a permit in the following locations:

- a. Facility Management shops,
- b. Blacksmith shop,
- c. Machine shops,
- d. Fabrication shop,
- e. Fleet shops, and
- f. Maintenance shops.

Only a hot work supervisor may approve the use of hot work in a location other than the pre-approved locations listed above. This is done by completing the Hot Work Permit found in Attachment A. The completed hot work permit must remain at the site until the project is complete and the permit is closed. Departments are to maintain permits for two years.

D. Worksite Hazard Assessment and Mitigation

1. The hot work supervisor will determine combustible materials and hazardous areas present or likely to be present at the proposed work location. The supervisor will reduce or abate the hazardous condition(s) with one of the following methods:
 - a. Have the work moved to a location free from dangerous combustibles,

- b. If the work cannot be moved, have the combustibles moved to a safe distance from the work (at least 35 feet) or have the combustibles properly shielded, or
 - c. Schedule hot work operations at a time when combustibles are absent or can be moved from the work area.
 2. The following restrictions apply to performing hot work in a permanent building or structure:
 - a. A hot work permit is required;
 - b. Nearby smoke alarms may be disabled prior to beginning work. If smoke alarms are disabled, affected employees must be notified of the exact location and duration of the work;
 - c. Disabled smoke alarms must be reactivated immediately after completion of the work; and
 - d. When work is complete, affected employees must be notified that the work is complete and alarms have been reactivated.
 3. Brazing, cutting, or welding is permitted only in areas that are, or have been made, fire safe. Namely:
 - a. If combustible materials (e.g., paper, wood shavings and textiles) are on the floor, the floor must be swept clean for a radius of 35 feet. Combustible floors will be kept wet, covered with damp sand, or otherwise protected.
 - b. Where there are cracks or openings in the floor, walls, open doorways or windows exist and they which cannot be closed or covered, precautions will be taken so that no readily combustible materials on the floor below will be exposed to sparks which potentially could drop through the floor or other openings.
 - c. Ducts, fans, or conveyor systems that might carry sparks to distant combustibles or promote the migration of smoke and fume to occupied areas will be suitably protected or shut down. In the event that ducts, fans, or conveyor systems cannot be shut down or protected, portable welding exhaust systems that produce velocities of 100 fpm in the welding zone will be utilized.
 - d. If welding is to be done on a metal wall, partition, ceiling, or roof, precautions must be taken to prevent ignition of combustibles on the other side due to conduction or radiation, preferably by relocating combustibles.
 4. Brazing, cutting, and welding operations will be conducted and permitted only when the following protections are in place:
 - a. Personnel are properly outfitted with personal protective equipment;
 - b. Shielding is in place to keep others from viewing the arc (as required by the hot work supervisor); and
 - c. Adequate ventilation is in place and functioning to keep operators from inhaling toxic gases and fumes.

E. Fire Watch

1. Fire watchers are required whenever welding or cutting is performed in locations where a hot work permit is required.
2. Fire watchers must be trained in the use of fire extinguishing equipment. They will be familiar with means for sounding an alarm in the event of a fire. They must watch for fires in all exposed areas, sound the alarm if necessary, and attempt to extinguish fires only when within the capability of the equipment available. A fire watch will be maintained for at least 30 minutes after completion of work.
3. Suitable fire extinguishing equipment must be maintained nearby and ready for use while brazing, welding, and cutting are being performed and during fire watch activities.

III. Program Evaluation

The Human Resources Department - Risk Management Division will evaluate and update the Hot Work RCP annually in partnership with department safety coordinators.

**Attachment A
Hot Work Permit**

1. Hot Work Supervisor Name:	2. Date and Time of Work:	3. Have emergency fire response procedures been reviewed? <input type="checkbox"/> yes <input type="checkbox"/> no
4. Is a confined space permit required? If so, complete and provide a copy to Risk Management. <input type="checkbox"/> yes <input type="checkbox"/> no	5. Is Lockout/Tagout required? <input type="checkbox"/> yes <input type="checkbox"/> no	6. Hot Work Equipment to be used:
7. Location and equipment to be worked on:		
8. Reason for completing this Hot Work Permit (check all that apply): <input type="checkbox"/> Combustible materials in the work area <input type="checkbox"/> Work area has potential for flammable vapors <input type="checkbox"/> Work area has potential for an oxygen-enriched atmosphere <input type="checkbox"/> Work will not be done in a permanent building		
9. Fire Prevention Procedures to be used during hot work:		
Yes/No <input type="checkbox"/> <input type="checkbox"/> Lockout/Tagout <input type="checkbox"/> <input type="checkbox"/> Test for flammable vapors with gas detector <input type="checkbox"/> <input type="checkbox"/> Erect fire-resistant barriers <input type="checkbox"/> <input type="checkbox"/> Place fire extinguishers around work site <input type="checkbox"/> <input type="checkbox"/> Wet down floor <input type="checkbox"/> <input type="checkbox"/> Cover floor with wet sand <input type="checkbox"/> <input type="checkbox"/> Portable welding ventilation <input type="checkbox"/> <input type="checkbox"/> Drums filled with wet sand <input type="checkbox"/> <input type="checkbox"/> Drums filled with water <input type="checkbox"/> <input type="checkbox"/> Fire watch	Yes/No <input type="checkbox"/> <input type="checkbox"/> Confined Space Entry Procedure <input type="checkbox"/> <input type="checkbox"/> Displace pipeline/tank with water <input type="checkbox"/> <input type="checkbox"/> Ventilate area to control flammable vapors <input type="checkbox"/> <input type="checkbox"/> Clear work area of combustibles <input type="checkbox"/> <input type="checkbox"/> Place water hoses around work site <input type="checkbox"/> <input type="checkbox"/> Other (list below)	
10. Persons Conducting Hot Work:		
Name and Department _____		
Name and Department _____		
Name and Department _____		
Fire Watch, Name/Department _____		
Fire Watch, Name/Department _____		
11. Authorizing Hot Work Supervisor:		
Name _____ Signature _____		
Date: _____		
12. Fire Watch has been maintained for 30 minutes after completion of hot work. All ignition sources have been extinguished. This permit is closed.		
Date and Time: _____		
Fire Watch Name(s): _____		
Signature(s): _____		



County of El Dorado, California

Regulatory Compliance Program No. 15 Lead Exposure Control

I. Purpose

In accordance with California Code of Regulations (CCR) Title 8, Sections 1532.1 and 5198, this regulatory compliance program (RCP) provides procedures to minimize occupational exposure to lead. It is the intent of the County of El Dorado (County) to maintain work environments that control all worker exposures to less than the permissible exposure limit.

This RCP applies to all County employees, volunteers, and students (workers) who may be exposed to lead in the workplace, and specifically to workers at the following facilities:

The Firing Range located at 5941 Union Mine Road, El Dorado, CA is used by County Sheriff Deputies and includes:

- 1) A Pistol/Small-Bore Facility;
- 2) A Rifle Range;
- 3) A Wedge General Purpose Range; and
- 4) A Trap Range.

The Facilities Management Division includes paint, carpentry, and other trades shops which employ facility maintenance workers. Facility maintenance workers perform work in County-owned facilities throughout El Dorado County.

II. Procedures and Requirements

A. Exposure Assessment

Each operation with potential for worker exposure will be monitored to make an initial determination if workers are exposed to lead at or above the action level or permissible exposure limit. The initial determination will be based upon monitoring of a representative sample of workers exposed to the highest concentrations of lead. Surface wipe samples will be collected periodically in firing range facilities to verify that cleaning procedures are effective. Acceptable levels for lead dust are less than 400 micrograms per square foot for the range and 40 micrograms per square foot in the common areas behind the firing line. Workers will be notified in writing of the results of exposure monitoring that represents their exposure within five working days after the County's receipt of results. Perform personal monitoring for each type of worker task with a potential lead exposure in accordance with the sampling procedures and log in Attachment A.

1. Negative Initial Determination: If workers are exposed to airborne lead concentrations less than the action level, no further testing is required. Additional exposure monitoring is required if there are changes in production, equipment, process, control, or personnel that may result in new or increased worker exposures to lead.
2. Positive Initial Determination: If initial monitoring reveals worker exposure at or above the action level but no greater than the permissible exposure level, monitoring will be repeated at least every six months until two consecutive measurements taken seven days apart are at or below the action level.

3. Permissible Exposure Limit (PEL) Exceeded: If initial monitoring reveals worker exposure above the PEL, monitoring will be repeated quarterly until at least two consecutive measurements taken seven days apart are at or below the PEL.

B. Control Measures

1. Procedures for cleaning firing range areas are included in Attachment B. Procedures for building maintenance and renovation are included in Attachment C.
2. Signs will be posted in firing range areas stating the hazards of lead exposure and that there is a potential for exposure. Signs will be posted recommending washing face and hands after range use and advising "No Food, No Drinks, No Smoking, and No Tobacco Products".
3. Lead free frangible rounds will be used inside the live fire shoot house.
4. The bullet trap dust collection system must be operational at all times during operation of the enclosed range.
5. The mechanical ventilation system must be operational at all times during operation of the Mangan range. Proper operation of the Mangan ventilation system will be verified every 3 months.

C. Personal Protective Equipment

Respiratory protection will be provided if engineering and work practice controls are not sufficient to reduce exposures below the PEL, there are periods of unknown exposure while conducting assessment or a worker requests a respirator. If workers are exposed to lead above the PEL or the possibility of skin or eye irritation exists, appropriate protective work clothing and equipment will be provided. Protective equipment may include but is not limited to coveralls, gloves, hats, shoes, shoe covers, face shields, and eye protection. Protective clothing and equipment will be handled, cleaned, laundered, disposed of, and replaced as needed to contain and control exposure to lead.

D. Medical Surveillance

The County will provide medical surveillance for workers who are exposed at or above the action level for more than 30 days in any 12 consecutive months. All medical examinations will be conducted under the supervision of a licensed physician, in compliance with California Occupational Safety and Health Administration (Cal/OSHA) requirements, at no cost to the worker and according to the following schedule.

1. Blood lead and zinc protoporphyrin sampling and analysis shall be offered every six months. If blood lead level is at or above 40 mg/100g of whole blood, follow-up testing will be offered within two weeks of the employee's receipt of their results. Blood sampling and analysis will be offered every two months until two consecutive samples indicate blood lead level is below 40 mg/100g of whole blood.
2. Annual medical exams will be offered to workers whose blood test, conducted any time during the preceding 12 months, indicated a blood lead level at or above 40 mg/100g of whole blood.

3. Workers with a blood lead level at or above 40 mg/100g of whole blood will be notified in writing with in five working days after the County's receipt of biological monitoring results.

Workers with a blood lead level at or above 50 mg/100g of whole blood will be temporarily removed from work involving lead exposure until a medical determination that the worker is no longer at increased risk of health impairment due to exposure to lead and blood lead level is at or below 40 mg/100g of whole blood. Blood tests will be offered weekly during periods of medical removal.

Action Level - An eight hour time weighted exposure of 30 micrograms of airborne lead per cubic meter of air.

PEL - An eight hour time weighted exposure of 50 micrograms of airborne lead per cubic meter of air.

III. Training

Employees and supervisors who conduct lead related construction, renovation, or maintenance work in public buildings must be trained by a provider accredited and certified by the California Department of Health Services. Potentially affected workers will be provided initial training prior to assignment of job duties. Refresher training will be provided annually for workers who are subject to lead exposure at or above the action level or who have the possibility of skin or eye irritation due to lead exposure. Other workers with potential for exposure to lead will be provided training which includes an explanation of:

- A. Workplace lead regulations and specific operations that could result in exposure
- B. Permissible exposure limit and action level for lead
- C. Health effects of lead and medical monitoring requirements including information on chelating agents
- D. Job specific work practices, cleaning procedures, and use of engineering controls
- E. Selection, use, fitting, and limitations of respirators and personal protective equipment
- F. Contents of the County's Lead Exposure Control Program
- G. Proper disposal of contaminated material
- H. Employee rights to obtain exposure and medical records

IV. Recordkeeping

The County maintains records of all exposure monitoring activities including negative exposure assessments. All records shall be made available upon request to affected workers, former workers, or their designated representatives. The records will be maintained for at least 40 years or for the duration of employment plus 20 years, whichever is longer. These records include the following:

- A. Exposure monitoring data and information pertaining to variable worksite conditions will be documented on the log provided in Attachment A.
- B. Medical surveillance records including worker medical history and medical examination results will be maintained at the facility conducting the medical

monitoring. Results of biological monitoring will be maintained in the County's non-industrial medical files.

- C. Medical removal information for a worker due to exposure to lead will be documented in the County's non-industrial medical files. This information will include each date a worker was removed, date the worker returned to duty, the cause of removal, and statements explaining how the removal was handled.
- D. Objective exposure data can be obtained from material testing or industry-wide studies and may include information that documents a particular product, material, procedure, operation, or activity cannot release lead dust or fumes above the action level. Objective data used to assess exposure will be documented in the Human Resources Department - Risk Management Division's (Risk Management) material testing inventory.

V. Program Evaluation

Risk Management will evaluate and update the Lead Exposure Control RCP annually in partnership with department safety coordinators.

**Attachment A
Air Monitoring Procedures – Lead Exposure**

Lead — NIOSH 7082, 7105, and 7300

NIOSH Methods 7082, 7105, and 7300 include elemental analysis and are not compound specific. Portions of a sample can be analyzed separately for additional elements for sampling efficiency. Each of these methods offers a different analysis method.

NIOSH 7082: The working range is 0.05 to >1 mg/m³ for a 200-liter air sample. The method is applicable to elemental lead, including Pb fume, and all other aerosols containing lead. This is an elemental analysis, not compound specific. Aliquots of the samples can be analyzed separately for additional elements.

NIOSH 7105: The working range is 0.002 to >1 mg/m³ for a 200-liter air sample. If high concentrations are expected, the samples should be analyzed by AAS-GF. The method is applicable to elemental lead, including Pb fume, and all other aerosols containing lead. This is an elemental analysis, not compound specific. Aliquots of the samples can be analyzed separately for additional elements.

NIOSH 7300: The working range is 0.005 to 2.0 mg/m³ for each element in a 500-liter air sample. This is simultaneous elemental analysis, not compound specific.

Required Equipment:

1. An **air sampling pump** capable of sampling at the recommended flow rate with the sampling medium in line, such as:
 - SKC **Universal Sampler**
 - SKC **AirChek® 2000 Sampler**
 - SKC **AirChek XR5000 Series Sampler**
 - SKC **AirChek 52 Sampler**
2. An **air flow calibrator**, such as:
 - **Defender Primary Standard Calibrator** Cat. No. 717 Series
3. SKC **Preloaded Filter Cassette** Cat. No. 225-3-01
4. SKC **Filter Cassette Holder** with flexible tubing Cat. No. 225-1

Optional Equipment:

1. SKC **Cassette Shrink Bands** Cat. No. 225-25

SKC Sample Setup Guides:

1. Sampling Train — Filters and Cyclones, 1166
2. Calibrating a Pump Using an Electronic Calibrator, 1366

TWA	
Flow Rate	1000 to 4000 ml/min
Sample Time	varies*
Air Volume	varies*
NIOSH REL	0.05 mg/m ³
<i>(NIOSH Manual of Analytical Methods [NMAM], Fourth Edition, 3/15/03)</i>	
<i>* Refer to method for detail.</i>	

Sampling and Analysis:

1. To set up a filter cassette sampling train, prepare a loaded filter cassette, seal it with a shrink band (optional), insert the filter cassette into the filter cassette holder with the cassette inlet facing down, and remove the inlet and outlet plugs. Connect the fitting on the end of the rubber tubing of the filter cassette holder to the filter cassette outlet. With the flexible tubing provided, connect the filter cassette holder to the pump

inlet. Request SKC Sample Setup Guide 1166 for more information on preparing filter sampling trains.

2. For calibrating the pump, use the sampling train described above and connect the inlet of the filter cassette to the calibrator with flexible tubing. Calibrate the pump flow rate to the rate specified in the method. When calibration has been completed, remove the filter cassette, reinsert the plugs, and save the filter cassette for recalibration at the end of sampling. Request SKC Sample Setup Guide 1366 for more information on calibrating a pump.

3. For sampling, set up a sampling train as above except use a new filter cassette and do not remove the inlet plug on the filter cassette inlet until ready to sample. The inlet of the filter cassette should be facing down. Attach the cassette holder clip to a worker's collar and the pump to the worker's belt. Remove the filter cassette inlet plug and turn on the pump.

4. Sample at an accurately known flow rate for the recommended period of time.

5. At the end of the sampling period, turn off the pump and note the ending time. Cap the inlet and outlet of the cassette with the plugs provided and record any pertinent sampling information.

6. Calibrate the pump with the representative sampling media in line to verify that the flow has not changed by more than 5%.

7. Submit field blanks from the same lot number as the sample filters. Field blanks should be subjected to exactly the same handling as the samples (load, seal, and transport) except that no air is drawn through them.

8. Pack sample filters, field blanks, and all pertinent information securely for shipment to a laboratory for analysis.

Analyzing Method:

- NIOSH 7082:** Atomic absorption spectroscopy - flame (AAS-F)
NIOSH 7105: Atomic absorption spectroscopy - graphite furnace (AAS-GF)
NIOSH 7300: Inductively coupled plasma - atomic emission spectroscopy (ICP-AES)

Copyright 1992 - 2013

Attachment B
Firing Range – Lead Cleaning Guidelines

Enclosed firing ranges require frequent cleaning. Walls, floors, ceilings, and bullet traps must be cleaned regularly to prevent lead dust from becoming an airborne inhalation hazard to people using the range. It is essential to use appropriate methods to clean the firing range.

Cleaning Guidelines

1. Vacuuming is the preferred method for cleaning work areas. Shoveling, wet sweeping, or brushing may be used only when vacuuming or an equally effective method has been found ineffective.
2. Use a vacuum cleaner equipped with a high efficiency particulate air (HEPA) filter to remove lead-contaminated dust.
3. Compressed air may not be used to clean surfaces that may be contaminated with lead.
4. Wear appropriate work clothing, gloves, shoes, and an approved respirator if the need for respiratory protection is indicated by exposure monitoring.

Indoor and Semi-Enclosed Firing Ranges

1. Wear disposable "Tyvek" suit and gloves. A respirator with HEPA filters is required, unless exposure assessment of cleaning methods has documented that respiratory protection is not necessary.
2. Use a HEPA vacuum to clean the floor and walls.
3. After vacuuming, use a pressure washer to spray down floor and walls. Start at the firing line and work toward the bullet trap. Use a squeegee to push excess water toward bullet trap.

Brass Casings and Bullet Traps

1. Wear disposable gloves when collecting brass casings. Do not dry sweep. Store brass casings in a covered metal container.
2. Empty buckets containing lead fragments into approved metal containers wearing the same personal protective equipment used to clean the firing range.
3. Mining of rubber bullet traps will be performed by a qualified contractor only.

Common Areas

1. Wear disposable gloves.
2. Wipe all horizontal surfaces using wet cloths.
3. Bag wipes for proper disposal as contaminated waste.
4. Use a disposable "Swiffer" type dust mop or HEPA vacuum to clean the floor.

Waste Disposal

1. Store lead fragments, dust, vacuum filters and contaminated cleaning wipes, mops and personal protective equipment in accordance with the California Department of Toxic Substances Control regulations for disposal by a contractor approved by Risk Management.
2. Brass shell casings will be stored in closed containers for recycling by and approved contractor.

Attachment C
Facilities Maintenance – Lead Paint Guidelines

Interior paints and primers manufactured prior to 1978 often contain lead. Industrial and exterior paints and coatings are not regulated and must be considered suspect for containing lead. Disturbance of surfaces coated with materials containing lead may create an airborne inhalation hazard for workers.

It is essential to use appropriate methods when conducting building renovation and maintenance activities.

Renovation and Maintenance Guidelines

1. Buildings constructed prior to 1978 and all exterior and industrial coated surfaces must be tested for lead content prior to conducting any work in which painted or coated surfaces will be demolished, sanded, scraped, cut, drilled, welded, blasted, heated, or treated in any manner which generates airborne dust or fumes.
2. Initial screening of surfaces shall use bulk sampling and will include each unique surface that may contain lead. Sampling will be conducted by County staff or contract personnel trained in lead sampling procedures. Samples will be analyzed for any detectable amount of lead by a qualified laboratory.
3. Risk Management staff will receive and compile lead testing data into a County-wide inventory. Copies of the laboratory reports must be forwarded to Risk Management to assure accuracy of the lead materials inventory.
4. Persons responsible for sampling will notify the County representative overseeing in-house or contract work of all lead testing results.
5. If no lead is detected, no further action is necessary. County personnel can perform renovation and maintenance work as needed.
6. If lead is detected, work must be performed by a qualified contractor or qualified County workers. County workers must follow a work plan and use approved work practices.
7. A Cal/OSHA pre-job notification is required for disturbance of more than 100 square or lineal feet of material containing 0.5% lead or greater.



County of El Dorado, California

Regulatory Compliance Program No. 16 Office Safety

I. Purpose

To assure compliance with the California Code of Regulations, (CCR) Title 8, Section 1509, this regulatory compliance program (RCP) provides guidance to office managers and staff on the elements of safe office work and applies to all County of El Dorado (County) employees who work in an office environment. An office, like any other work environment, presents potential health and safety hazards. However, most of these hazards may be minimized or eliminated by designing jobs and workplaces properly, and by taking into account differences among tasks and individuals.

II. Responsibilities

A. Department directors or their designees are responsible for ensuring their employees are familiar with the Office Safety RCP.

B. Managers/Supervisors

Managers and supervisors are responsible for ensuring office equipment is in safe working condition, providing adequate storage for office supplies and for training employees. In accordance with the County's Injury and Illness Prevention Plan, they are also responsible for conducting and documenting regular worksite inspections (Attachment A), training employees, and following up on safety concerns.

C. Department Safety Coordinators

Each department safety coordinator (DSC) is responsible for conducting and documenting regular worksite inspections (Attachment A) in partnership with managers and supervisors.

D. Office Staff

Office staff is responsible for maintaining a neat and sanitary office environment and for reporting all safety issues immediately to their supervisor. It is not their responsibility to repair any office equipment or systems. They are also expected to participate in safety training and drills.

III. Procedures

A. General Electrical Safety

1. Electric cords should be examined on a routine basis for frayed and exposed wiring. Particular attention should be paid to connections behind furniture since filing cabinets and bookcases may be pushed tightly against outlets, severely bending the cord at the plug. Electrical appliances must be approved and used in accordance with Underwriters Laboratory (UL) or other recognized national testing authority requirements.
2. Use of Extension Cords
 - a. Extension cords may only be used temporarily and in situations where fixed wiring is not feasible.

- b. Extension cords must be kept in good repair; free from defects in their insulation; and not kinked, knotted, abraded, or cut.
- c. Extension cords must be placed so they do not present a tripping or slipping hazard.
- d. Extension cords must not be placed through doorways having doors that can be closed, thereby damaging the cord.
- e. All extension cords must be of the grounded type (three prongs).

B. Housekeeping

- 1. Good housekeeping is an essential element of accident prevention in offices. Poor housekeeping may lead to fires, injuries to personnel, or unhealthy working conditions. Falls and mishaps caused by dropping heavy cartons or other office equipment and supplies could also be a source of serious injuries to personnel.
- 2. Passageways and aisles in offices should be clearly defined and kept free and clear of obstructions. Proper layout, spacing, and arrangement of equipment and furniture are essential.
- 3. Chairs, filing cabinets, bookcases, and desks must be replaced or repaired if they become damaged. Filing cabinet and desk drawers should always be kept closed when not in use. Heavy files should be placed in the bottom file drawers.
- 4. Materials stored within supply rooms and cabinets must be neatly stacked and readily reached by adequate aisles. Care should be taken to stack materials so they will not topple over. Under no circumstances may materials be stacked within 18 inches of fire sprinkler heads. Materials must not be stored so that they project into aisles or passageways in a manner that could cause persons to trip or hinder emergency evacuation.
- 5. Electrical panels must not be blocked. They must have at least 18 inches of clearance on both sides and 36 inches in front of panel.

C. Ergonomics

- 1. Complaints concerning musculoskeletal problems are frequently heard from computer operators. The most common complaints are related to the neck, shoulders, and back. Other concerns are the arms and hands and occasionally the legs. The key to comfort is maintaining the body in a relaxed, natural position. The ideal work position is to have the arms hanging relaxed from the shoulders. If a keyboard is used, arms should be bent at right angles at the elbow, with the hands held in a straight line with forearms and elbows close to the body. The head should be in line with the body and slightly forward. For more information on ergonomics, refer to Regulatory Compliance Program No. 9 (Ergonomic Program). Common factors which have been identified and associated with increased risk of musculoskeletal problems include:
 - a. Design of the workstation
 - b. Nature of the task

- c. Repetitiveness of the job
- d. Degree of postural constraint
- e. Work pace
- f. Work/Rest schedules
- g. Personal attributes of individual workers

2. Chairs

The chair is usually the most important piece of furniture that affects user comfort in the office. An ergonomically sound chair includes five means of adjustment - seat pan tilt, backrest angle, seat pan depth, seat height, and backrest height. Operators can then vary the chair adjustments according to the task and comfort. Chairs should have five wheels, and be adjusted for comfort so the back is supported and that the seat pan is at a height where the thighs are horizontal and feet are flat on the floor.

3. Working Height

The work surface height should fit the task and allow work to be performed with arms low and close to the body in relation to the task. Sit/Stand work stations allow for maximum flexibility for work stations with multiple users.

4. Work/Rest Schedules

Stress and fatigue may be minimized by designing work flow so that tasks requiring concentrated work at the terminal are alternated with non-computer based tasks throughout the workday. Also, short breaks (i.e., 3 to 5 minutes) should be taken at least once each hour when involved in continuous work at the computer.

5. Other Solutions

Additional measures that will aid in reducing discomfort while working with computers include:

- a. Change position, stand up, or stretch whenever you start to feel tired.
- b. Use a soft touch on the keyboard and keep your shoulders, hands, and fingers relaxed.
- c. Use a document holder, positioned at about the same height and distance as the display screen.
- d. Rest your eyes by occasionally looking off into the distance, blinking, or closing them.

D. Office Lighting

Different tasks require different levels of lighting. For example, areas in which intricate work is performed require greater illumination than warehouses. Lighting needs vary from time to time and person to person as well. One approach is to use adjustable task lighting that can provide needed illumination without increasing general lighting.

The Board of Supervisors Policy A-18, Energy Conservation Policy, states the maximum illumination levels for County of El Dorado offices to be 50 foot candles. The minimum recommended illumination levels in an office setting are 20 foot candles. Offices may regulate their lighting to the preferences and comfort of those working in the area, as long as the illumination levels remain between 20-50 foot candles.

E. Waste Disposal

Whenever feasible, cardboard, paper, plastic, and metals should be recycled. Office personnel should carefully handle and properly dispose of hazardous trash, such as broken glass. A waste receptacle containing broken glass or other hazardous materials should be labeled to warn maintenance personnel of the potential hazard. Whenever possible, put broken glass in a hard-walled container and sealed with packing tape. Alkaline batteries, rechargeable batteries, and fluorescent light tubes must be disposed of properly as universal waste. For more information on proper disposal, including needle (sharps) disposal, contact the Human Resources Department - Risk Management Division (Risk Management) at 530-621-5565.

F. Hazard Communication

Each office employee must be made aware of all hazardous materials (e.g., chemicals) they may contact in their work area. For more information, refer to Regulatory Compliance Program No. 13 (Hazard Communication Program).

G. Emergency Action Plans

Emergency Action Plans are developed to control unplanned events and minimize the effects. Through careful pre-planning, establishment of Emergency Action Teams, training and drills, employees, and visitors can be safeguarded and the potential for damage to County assets is minimized. Emergency Action Team Members (e.g., supervisors, safety coordinators, and key assigned members) must be trained annually. All facilities must have annual drills to assess the effectiveness of the Emergency Action Plan. All employees are expected to participate in the drills. For more information, refer to Regulatory Compliance Program No. 8 (Emergency Action Plans). Emergency Action Plans typically include:

1. Exits routes, meeting areas, and employee accounting systems;
2. Emergency evacuation triggers, incident command, and notification of emergency services; and
3. Facility security.

H. Fire Extinguishers

Staff must be informed regarding the locations and classifications of portable fire extinguishers. Only staff trained at the County in the proper use of fire extinguishers should attempt to use one. If you use a fire extinguisher for any reason, it must be reported to Facilities management so it can be replaced with a charged extinguisher. It is also recommended that staff notify the fire department after using a fire extinguisher to put out a fire of any size, so fire personnel can inspect the facility and make sure the fire is completely extinguished. See Regulatory Compliance Program No. 10 (Fire Prevention Program) for more information.

I. Preventing Slips, Trips, and Falls

Slips, trips, and falls are a leading cause of injuries in any workplace and these types of injuries are easily prevented. Simple steps, like good housekeeping and being aware of surroundings, can help reduce the chances of staff becoming injured by a slip, trip, or fall. Spills should be cleaned up immediately. Handrails should also be used consistently on stairs.

J. Safe Office Attire

Wear loose, comfortable clothing that best fits the job task and working environment, unless doing so would increase the potential for injury (e.g., neckties, long hair, or loose sleeves around rotating parts). Whenever possible, avoid open-toed shoes and sandals. This type of footwear is not allowed where material handling is conducted. Wear comfortable footwear with a good sole to reduce leg and back strain, and to help prevent slips and falls.

K. Back Injury Prevention

Most back injuries are cumulative in nature. They may be caused by a prior injury flaring up, continued use of a heavy tool in the same position, or if a great deal of time is spent in the same position. Remember that most back injuries can be attributed to poor posture, poor body mechanics, poor work habits, stressful living, loss of flexibility, and/or poor conditioning. Most back injuries are avoidable if employees make the correct lifting choices. By focusing on strength, flexibility, and overall quality of life, staff can eliminate or minimize back injuries. Employees are encouraged to exercise, eat right, and stretch as often as possible to help prevent injuries, and to minimize recovery time due to injuries.

L. Electronic Office Equipment Hazards

1. Unsafe/Non-Approved Equipment

All poorly maintained or unsafe, poor quality, non-rated (i.e., UL listed) coffee makers, radios, lamps, etc. may not be used in County facilities. Such appliances can develop electrical shorts and create a fire and/or shock hazards. Equipment and cords should be inspected regularly and only a qualified individual should make repairs.

2. Live Parts Unguarded

Wall receptacles should be designed and installed so that no current-carrying parts will be exposed. All receptacle cover plates should be kept tight to eliminate the possibility of shock. All broken or cracked cover plates, as well as any unsafe electrical conditions, should be reported to Facilities management immediately.

3. Working on "Live Equipment"

Disconnect electrical equipment before cleaning, adjusting, or applying flammable solutions. If a guard is removed to clean or repair parts, replace it before testing the equipment and returning the equipment to service. Only trained personnel should attempt to repair any equipment.

4. Electrical Panel Doors

If an electrical malfunction should occur, the panel door and anything else in front of the door will become very hot. Electrical panel doors should always be kept closed to prevent "electrical flashover" in the event of an electrical malfunction, and nothing can be stored within 36" of the panels. All breakers within the panels should be clearly labeled too.

5. Office Equipment

It is important that all staff understand how to properly operate electronic office equipment. Reading and following the instructions is essential, but so is communicating restrictions. In particular, all staff must understand the appropriate response when a piece of equipment malfunctions. For instance, when paper jams in a photocopier, reaching into a copier can result in burns or even electrocution.

Only trained staff should attempt to unjam the equipment. Certain materials, such as plastic transparency sheets, should not be used in some copiers. At the end of the day, be sure to power down all electrical equipment. The names/phone numbers of repair or service providers should be posted prominently near the copier, fax, or other equipment. When in doubt, contact the vendor or repair professional for assistance.

IV. Program Evaluation

Risk Management will evaluate and update the Office Safety RCP annually in partnership with DSCs.

**Attachment A
Office Safety Inspection Checklist**

This checklist is intended as a guide to assist employees in conducting periodic safety and health inspections of their work areas. Questions which receive a "NO" answer require corrective action. For questions or assistance with resolving problems, please contact Risk Management at 530-621-5565.

Location: _____

Inspector Name: _____ Inspection Date: _____

Work Environment			
Yes	No	N/A	
<input type="radio"/>	<input type="radio"/>	<input type="radio"/>	Are all work areas clean, sanitary, and orderly?
<input type="radio"/>	<input type="radio"/>	<input type="radio"/>	Is there adequate lighting?
Walking / Working Surfaces			
Yes	No	N/A	
<input type="radio"/>	<input type="radio"/>	<input type="radio"/>	Are aisles and passages free of stored material that may present trip hazards?
<input type="radio"/>	<input type="radio"/>	<input type="radio"/>	Are tile floors in places like kitchens and bathrooms free of water and slippery substances?
<input type="radio"/>	<input type="radio"/>	<input type="radio"/>	Are carpet and throw rugs free of tears or trip hazards?
<input type="radio"/>	<input type="radio"/>	<input type="radio"/>	Are hand rails provided on all fixed stairways?
<input type="radio"/>	<input type="radio"/>	<input type="radio"/>	Are treads provided with anti-slip surfaces?
<input type="radio"/>	<input type="radio"/>	<input type="radio"/>	Are stepladders or stools provided for reaching overhead storage areas and are materials stored safely?
<input type="radio"/>	<input type="radio"/>	<input type="radio"/>	Are file drawers kept closed when not in use?
<input type="radio"/>	<input type="radio"/>	<input type="radio"/>	Is furniture free of any unsafe defects?
<input type="radio"/>	<input type="radio"/>	<input type="radio"/>	Are heating and air conditioning vents clear of obstructions?
Emergency Information (Postings)			
Yes	No	N/A	
<input type="radio"/>	<input type="radio"/>	<input type="radio"/>	Are employees trained on emergency procedures?
<input type="radio"/>	<input type="radio"/>	<input type="radio"/>	Are fire evacuation procedures/diagrams posted?
<input type="radio"/>	<input type="radio"/>	<input type="radio"/>	Are the Cal/OSHA poster and other required posters displayed conspicuously?
<input type="radio"/>	<input type="radio"/>	<input type="radio"/>	Is a copy of the facility emergency action plan available on site?
<input type="radio"/>	<input type="radio"/>	<input type="radio"/>	Are safety hazard warning signs/caution signs provided to warn employees of pertinent hazards?
Fire Prevention			
Yes	No	N/A	
<input type="radio"/>	<input type="radio"/>	<input type="radio"/>	Are portable fire extinguishers distributed properly (less than 75 feet travel distance for combustibles and 50 feet for flammables)?
<input type="radio"/>	<input type="radio"/>	<input type="radio"/>	Are employees trained on the use of portable fire extinguishers?
<input type="radio"/>	<input type="radio"/>	<input type="radio"/>	Are portable fire extinguishers visually inspected monthly and serviced annually?
<input type="radio"/>	<input type="radio"/>	<input type="radio"/>	Are areas around portable fire extinguishers free of obstructions and properly
<input type="radio"/>	<input type="radio"/>	<input type="radio"/>	Is heat-producing equipment used in a well ventilated area?
<input type="radio"/>	<input type="radio"/>	<input type="radio"/>	Are fire alarm pull stations clearly marked and unobstructed?
<input type="radio"/>	<input type="radio"/>	<input type="radio"/>	Are proper clearances maintained below sprinkler heads (i.e., 18" clear)?

Emergency Exits			
Yes	No	N/A	
<input type="radio"/>	<input type="radio"/>	<input type="radio"/>	Are doors, passageways or stairways that are neither exits nor access to exits and which could be mistaken for exits, appropriately marked "NOT AN EXIT," "TO BASEMENT," "STOREROOM," etc?
<input type="radio"/>	<input type="radio"/>	<input type="radio"/>	Are a sufficient number of exits provided?
<input type="radio"/>	<input type="radio"/>	<input type="radio"/>	Are exits kept free of obstructions or locking devices which could impede immediate escape?
<input type="radio"/>	<input type="radio"/>	<input type="radio"/>	Are exits properly marked and illuminated?
<input type="radio"/>	<input type="radio"/>	<input type="radio"/>	Are the directions to exits, when not immediately apparent, marked with visible signs?
Electrical Systems			
Yes	No	N/A	
<input type="radio"/>	<input type="radio"/>	<input type="radio"/>	Are all cord and cable connections intact and secure?
<input type="radio"/>	<input type="radio"/>	<input type="radio"/>	Are electrical outlets free of overloads?
<input type="radio"/>	<input type="radio"/>	<input type="radio"/>	Is fixed wiring used instead of flexible/extension cords?
<input type="radio"/>	<input type="radio"/>	<input type="radio"/>	Is the area around electrical panels and breakers free of obstructions?
<input type="radio"/>	<input type="radio"/>	<input type="radio"/>	Are high-voltage electrical service rooms kept locked?
<input type="radio"/>	<input type="radio"/>	<input type="radio"/>	Are electrical cords routed such that they are free of sharp objects, clearly visible, in good condition and grounded?
<input type="radio"/>	<input type="radio"/>	<input type="radio"/>	Are electrical appliances approved (Underwriters Laboratory, Inc. (UL), etc)?
<input type="radio"/>	<input type="radio"/>	<input type="radio"/>	Are space heaters located away from combustibles and properly ventilated?
Material Storage			
Yes	No	N/A	
<input type="radio"/>	<input type="radio"/>	<input type="radio"/>	Are storage racks and shelves capable of supporting the intended load and materials stored safely?
<input type="radio"/>	<input type="radio"/>	<input type="radio"/>	Are storage racks secured from falling?
<input type="radio"/>	<input type="radio"/>	<input type="radio"/>	Is office equipment stored in a stable manner, not capable of falling?



County of El Dorado, California

Regulatory Compliance Program No. 17 Respiratory Protection Program

I. Purpose

This regulatory compliance program (RCP) serves as the County of El Dorado's (County) Respiratory Protection Program (RPP). Its primary objective is to protect employees against occupational diseases caused by breathing air contaminated with harmful dusts, fogs, fumes, mists, gases, smokes, sprays, or vapors. This RCP provides guidance to managers and staff on the County's Respiratory Protection Program. It applies to all employees required to use respiratory protection, as well as to all employees whose use of respiratory protection is voluntary, in order to assure compliance with the California Code of Regulations, Title 8, Sections 5144 (8CCR5144) and 3204 (8CCR3204). Definitions of the terms used in this RCP are found in Attachment A.

II. Responsibilities

Department directors or their designees will:

- A. Ensure that the written RPP is implemented throughout their departments;
- B. Coordinate with the Human Resources Department - Risk Management Division (Risk Management) to study worksite-specific procedures, operations, facilities, and equipment to determine employee exposure to harmful dusts, fogs, fumes, mists, gases, smokes, sprays, or vapors, as needed;
- C. Whenever practical, use engineering and/or administrative controls to reduce employee exposure to atmospheric contamination;
- D. When engineering and administrative controls are not sufficient, provide employees with appropriate respiratory protection equipment, training, medical evaluations, and annual fit testing at no cost to the employees;
- E. Implement specific worksite procedures describing when and how respirators will be used during routine work activities, infrequent activities, and reasonably foreseeable emergencies such as spill response, rescue, or escape situations;
- F. Make all reasonable efforts to provide fit testing, training, and medical evaluations during normal working hours;
- G. Provide a copy of 8CCR5144 Attachment D to all employees who are not required to use respiratory protection, but who choose to do so voluntarily, and also obtain employees' signatures on the statement that the employees have read and understand Attachment D;
- H. Evaluate the program regularly to ensure that procedures are followed, respirator use is monitored, and respirators continue to provide adequate protection when job conditions change; and
- I. Maintain records of the following according to the County's Records Retention policy:
 - a. Fit testing (including completed Voluntary Respirator Use Information Sheets, Attachment D to section 5144); and
 - b. Monthly inspection record for emergency use respirators.

Supervisors will:

- A. Monitor compliance with this plan by employees who have a potential for occupational exposure;
- B. Ensure that new employees are properly trained;
- C. Ensure that all employees using County provided respiratory protection attend annual training sessions; and
- D. Ensure respiratory protection equipment is available in accessible locations, used by personnel when appropriate, and stored properly when not in use.

Employees who wear or may wear a respirator will:

- A. Actively participate in all training, medical evaluations, and annual fit testing;
- B. Be responsible for inspecting the equipment prior to each use;
- C. Perform user seal checks, both positive and negative pressure, each time the respirator is put on per 8CCR5144 or manufacturer's instructions, (Attachment B);
- D. Clean the respirator after each use;
- E. Properly store the equipment;
- F. Report all problems to supervisor immediately; and
- G. Read and understand Attachment D from 8CCR5144 on voluntary use and return a signed copy to their supervisor.

Risk Management will:

- A. Oversee the development and updating of the RCP;
- B. Provide technical support for all departments who participate in this program;
- C. Assist in the study of specific operations, facilities, and equipment to determine employee exposure to harmful dusts, fogs, fumes, mists, gases, smokes, sprays, or vapors, as needed;
- D. Assist in respiratory protection equipment selection;
- E. Support departments in their efforts to provide fit-testing to all employees using County-provided respiratory protection equipment, whether use is voluntary or required;
- F. Provide training on the care and use of respiratory protection equipment;
- G. Facilitate the required medical evaluations; and
- H. Maintain records of medical evaluations, though not the medical evaluations themselves, which are maintained by the medical evaluator. Records of medical evaluations must be retained and made available in accordance with 8CCR3204 and the County's records retention policy;
- I. Maintain records of the written respiratory protection program according to the County's Records Retention policy.

III. Procedures

A. Selection of Respirators

1. General Requirements
2. The department head or designee, with the assistance of Risk Management, will select and provide an appropriate respirator based on the respiratory hazard(s) the employee is exposed to in the workplace along with other user factors that affect respirator performance and reliability as described in 8CCR5144 (d). A variety of respirator models and sizes will be provided to ensure that the respirator is acceptable to and correctly fits the user.
3. The respirator and all components used will be NIOSH (National Institute for Occupational Safety and Health)-certified and used in compliance with the conditions of its certifications.
4. Respiratory hazards in the workplace will be identified and evaluated by the department head or designee. This evaluation will include, but is not limited to, a reasonable estimate of employee exposures to respiratory hazard(s) as well as identification of the known or suspected contaminant's chemical state and physical form. If these determinations cannot be made, then the atmosphere is to be considered immediately dangerous to life and health (IDLH).
5. Selection of Respirators for IDLH atmospheres.
6. All oxygen-deficient atmospheres will be considered IDLH.
7. The department will provide a full facepiece, pressure-demand, self-contained breathing apparatus (SCBA), certified by NIOSH for a minimum service life of thirty minutes, or a combination full facepiece, pressure-demand, supplied-air respirator (SAR) with auxiliary self-contained air supply for IDLH atmospheres.
8. Compressed breathing air must be of highest purity and meet at least the requirements for Grade D breathing air described in American National Standard Institute (ANSI)/Compressed Gas Association Commodity Specification for Air, G-7.1-1989.
9. Respirators provided only for escape from IDLH atmospheres will be NIOSH certified for escape from the atmosphere in which they will be used.
10. Selection of respirators for atmospheres that are not IDLH
11. The department will provide a respirator that is adequate to protect the health of the employee and ensure compliance with all other California Occupational Health and Safety Administration (Cal/OSHA) statutory and regulatory requirements, both under routine and reasonably foreseeable emergency situations.
12. The respirator selected will be appropriate for the chemical state and physical form of the contaminant.
13. For protection against gases and vapors, the department will provide an atmosphere-supplying respirator, or an air-purifying respirator, provided that the respirator is equipped with an end-of-service-life indicator (ESLI) certified by NIOSH for the contaminant(s). If there is no ESLI appropriate for conditions in the workplace, the

department will implement a change schedule for canisters and cartridges that is based on objective information or data that will ensure that canisters and cartridges are changed before the end of their service life. The department will have standard operating procedures for the information and data relied upon and the basis for the canister and cartridge change schedule and the basis for reliance on the data.

14. For protection against particulates, the department will provide:

- i. An atmosphere-supplying respirator;
- ii. An air-purifying respirator equipped with a filter certified by NIOSH as a high efficiency particulate air (HEPA) filter; or
- iii. An air-purifying respirator equipped with a filter certified for particulates by NIOSH.
- iv. For contaminants consisting primarily of particles with mass median aerodynamic diameters (MMAD) of at least 2 micrometers, an air-purifying respirator equipped with any filter certified by NIOSH will be provided

B. Medical Evaluations

1. Prior to fit testing, prior to requiring the employee to use a respirator in the workplace, or prior to the voluntary use of County provided respiratory protection equipment, the department will arrange for a medical evaluation through Risk Management. The medical evaluation will be in accordance with the procedures outlined in 8CCR5144 to determine the employee's ability to use a respirator. The department may discontinue an employee's medical evaluations when the employee is no longer required to use a respirator.
2. After the initial medical evaluation, Risk Management will arrange for additional medical evaluations that comply with the requirements of 8CCR5144 if:
 - a. An employee reports medical signs or symptoms that are related to ability to use a respirator;
 - b. A physician or other licensed healthcare professional (PLHCP), supervisor, and/or Risk Management informs the department that an employee needs to be re-evaluated;
 - c. Information from the respiratory protection program, including observations made during fit testing and program evaluation, indicates a need for employee reevaluation; or
 - d. If a change occurs in workplace conditions (e.g., physical work effort, protective clothing, or temperature) that may result in a substantial increase in the physiological burden placed on an employee

C. Fit Testing

1. The department will ensure that employees using a tight-fitting facepiece respirator pass an appropriate OSHA-accepted qualitative fit test (QLFT) or quantitative fit test (QNFT) as outlined in Attachment C.

2. Fit testing will occur prior to use of the respirator, and annually thereafter, and whenever a different respirator facepiece (size, style, model, or make) is used, or whenever the employee reports, or a supervisor, PLHCP, or program administrator makes visual observations of changes in the employee's physical condition that could affect respirator fit. Such conditions include, but are not limited to, facial scarring, dental changes, cosmetic surgery, or an obvious change in body weight. Fit test results will be recorded using Attachment D.

D. Procedures for Proper Use

1. Routine Situations

- a. Employees will not be allowed to wear respirators with tight-fitting facepieces if they have facial hair (e.g., stubble, bangs), absence of normally worn dentures, facial deformities (e.g., scars, deep skin creases, prominent cheekbones), or other facial features that interfere with the facepiece seal or valve function. Jewelry or headgear that projects under the facepiece seal is also not allowed.
- b. If corrective glasses or other personal protective equipment are worn, they should not interfere with the seal of the facepiece to the face. Full facepiece respirators can be provided with corrective glasses since corrective lenses can be mounted inside a full facepiece respirator.
- c. Contact lenses can be worn with any type of respirator. While conditions requiring use of a respirator may be hazardous to both contact lens wearers and to people who do not, contact lens wearers should be aware that certain conditions may make it necessary to avoid wearing their contact lenses. In particular, the use of contact lenses is not recommended in dusty atmospheres while wearing a half-mask facepiece. Each situation should be carefully investigated and the employee should always inform his/her supervisor if contact lenses are in use. Situations in which to avoid the use of contacts may include:
 - Exposure to chemical fumes and vapors;
 - Areas where potential for chemical splash exists;
 - Areas where particulate matter or dust is in the atmosphere;
 - Exposure to extremes of infrared rays;
 - Intense heat;
 - Dry atmosphere;
 - Flying particles; and
 - Areas where caustic substances are handled, particularly those substances used or stored under pressure.
 - A seal check will be performed every time a tight-fitting respirator is donned. (Attachment B).

2. Infrequent Situations

Each employee will leave the area where respirators are required for any of the

following reasons:

- To replace filters or cartridges;
- When a smell or taste of a chemical is detected inside the respirator;
- When a change in breathing resistance is noticed;
- To adjust a respirator; or
- To wash face or respirator.

3. Emergency Situations

Each employee will leave the area where respirators are required for any of the following reasons:

- If the employee becomes ill;
- If the employee experiences dizziness, nausea, weakness, breathing difficulty, coughing, sneezing, vomiting, fever, or chills.

4. Potential IDLH Situations

Departments exposed to potential IDLH situations will prepare department specific procedures for routine, infrequent, and emergency situations involving use of SCBA's and SAR's.

E. Maintenance and Care

The department will provide for the cleaning and disinfecting, storage, inspection, and repair of respirators used by employees. Proper maintenance includes disassembling of all parts, discarding or repairing defective parts, washing components as per manufacturer's instructions, and reassembly, including installation of new parts as necessary. For most respirators, washing in warm water with mild detergent, rinsing in clean, warm, preferably running water, draining, air or hand drying with lint-free cloths, reassembling with new components as necessary and testing for proper function is sufficient. The department supervisors will ensure that all filters, cartridges, and canisters used in the workplace are labeled and color-coded with the NIOSH approval label, and that the label is not removed and remains legible at all times

F. Voluntary Use

Before the voluntary use of County-provided respirators is approved by the department in accordance with this RPP, the employee will:

1. Submit to a medical evaluation;
2. Receive initial training in the proper use, care, and limitations of the selected respirator; and
3. Obtain a successful fit test for those types of respirators to be worn by that employee.

IV. Training

Training for all employees using County provided respiratory protection, whether voluntary or required use, must be effective, comprehensive, and understandable. The training must recur annually, and more often, if necessary. The basic information on respirators must be provided to employees who wear respirators voluntarily when not required to do so by the County. The department will ensure that each employee can demonstrate knowledge of at least the following:

- A. Why the respirator is necessary, including the nature of the respiratory hazards in the workplace;
- B. How improper fit, usage, or maintenance can compromise the protective effect of the respirator;
- C. The limitations and capabilities of the respirator;
- D. How to use the respirator effectively in emergency situations, including situations in which the respirator malfunctions;
- E. How to inspect, put on and remove (don and doff), use, and check the seals of the respirator;
- F. How to clean, repair, and store the respirator;
- G. How to use a respirator in an emergency situation;
- H. What to do when a respirator fails;
- I. How to recognize medical signs and symptoms that may limit or prevent the effective use of respirators; and
- J. The general requirements of 8CCR5144.

V. Recordkeeping

Written RCP: Risk Management will update and maintain a current copy as needed to reflect those changes in workplace conditions that affect respirator use. This RPP will be reviewed at least every three years and the review will be documented.

Fit test records: Departments will retain fit test records until the next fit test is administered.

Employee training records: Departments will retain for the duration of employment plus three years.

Medical evaluations: The medical provider will retain these records, including written recommendations, for the duration of employees' employment plus thirty years.

VI. Program Evaluation

Departments and Risk Management will evaluate the effectiveness of the RPP by performing the following steps:

- A. Checking results of fit-tests and health provider evaluations;
- B. Talking with employees who wear respirators about their respirators – how they fit, do they think they are adequately protecting them, do they notice any odors while wearing them, etc.;

- C. Periodically checking employee job duties for changes in chemical exposure;
- D. Periodically checking maintenance and storage of respirators; and
- E. Periodically checking how employees use their respirators.

Attachment A Definitions

Air-purifying Respirator

A respirator with an air-purifying filter, cartridge, or canister that removes specific air contaminants by passing ambient air through the air-purifying element.

Assigned Protection Factor (APF)

The workplace level of respiratory protection that a respirator or class of respirators is expected to provide to employees when the employer implements a continuing, effective respiratory protection program as specified by 8CCR5144.

Atmosphere-supplying Respirator

A respirator that supplies the respirator user with breathing air from a source independent of the ambient atmosphere, and includes supplied-air respirators (SARs) and self-contained breathing apparatus (SCBA) units.

Canister or Cartridge

A container with a filter, sorbent, or catalyst, or combination of these items, which removes specific contaminants from the air passed through the container.

Demand Respirator

An atmosphere-supplying respirator that admits breathing air to the facepiece only when a negative pressure is created inside the facepiece by inhalation.

Emergency Situation

Any occurrence such as, but not limited to, equipment failure, rupture of containers, or failure of control equipment that may or does result in an uncontrolled significant release of an airborne contaminant.

Employee Exposure

Exposure to a concentration of an airborne contaminant that would occur if the employee were not using respiratory protection.

End-of-service-life Indicator (ESLI)

A system that warns the respirator user of the approach of the end of adequate respiratory protection, for example, that the sorbent is approaching saturation or is no longer effective.

Escape-only Respirator

A respirator intended to be used only for emergency exit.

Filter or Air Purifying Element

A component used in respirators to remove solid or liquid aerosols from the inspired air.

Filtering Facepiece (dust mask)

A negative pressure particulate respirator with a filter as an integral part of the facepiece or with the entire facepiece composed of the filtering medium.

Fit Factor

A quantitative estimate of the fit of a particular respirator to a specific individual, and typically estimates the ratio of the concentration of a substance in ambient air to its concentration inside the respirator when worn.

Fit Test

The use of a protocol to qualitatively or quantitatively evaluate the fit of a respirator on an individual. (See also Qualitative fit test QLFT and Quantitative fit test QNFT.)

Helmet

A rigid respiratory inlet covering that also provides head protection against impact and penetration.

High Efficiency Particulate Air (HEPA) Filter

A filter that is at least 99.97% efficient in removing monodisperse particles of 0.3 micrometers in diameter. The equivalent NIOSH 42 CFR 84 particulate filters are the N100, R100, and P100 filters.

Hood

A respiratory inlet covering that completely covers the head and neck and may also cover portions of the shoulders and torso.

Immediately Dangerous to Life or Health (IDLH)

An atmosphere that poses an immediate threat to life, would cause irreversible adverse health effects, or would impair an individual's ability to escape from a dangerous atmosphere.

Loose-Fitting Facepiece

A respiratory inlet covering that is designed to form a partial seal with the face.

Maximum Use Concentration (MUC)

The maximum atmospheric concentration of a hazardous substance from which an employee can be expected to be protected when wearing a respirator, and is determined by the assigned protection factor of the respirator or class of respirators and the exposure limit of the hazardous substance. The MUC can be determined mathematically by multiplying the assigned protection factor specified for a respirator by the required OSHA permissible exposure limit, short-term exposure limit, or ceiling limit. When no OSHA exposure limit is available for a hazardous substance, an employer must determine an MUC on the basis of relevant available information and informed professional judgment.

Negative Pressure Respirator (tight fitting)

A respirator in which the air pressure inside the facepiece is negative during inhalation with respect to the ambient air pressure outside the respirator.

Oxygen Deficient Atmosphere

An atmosphere with an oxygen content below 19.5% by volume.

Physician or Other Licensed Health Care Professional (PLHCP)

An individual whose legally permitted scope or practice (i.e., license, registration, or certification) allows him or her to independently provide, or be delegated the responsibility to provide, some or all of the health care services required by §5144(e).

Positive Pressure Respirator

A respirator in which the pressure inside the respiratory inlet covering exceeds the ambient air pressure outside the respirator.

Powered air-purifying Respirator (PAPR)

An air-purifying respirator that uses a blower to force the ambient air through air-purifying elements to the inlet covering.

Pressure Demand Respirator

A positive pressure atmosphere-supplying respirator that admits breathing air to the facepiece when the positive pressure is reduced inside the facepiece by inhalation.

Qualitative Fit Test (QLFT)

A pass/fail fit test to assess the adequacy of respirator fit that relies on the individual's response to the test agent.

Quantitative Fit Test (QNFT)

An assessment of the adequacy of respirator fit by numerically measuring the amount of leakage into the respirator.

Respiratory Inlet Covering

That portion of a respirator that forms the protective barrier between the user's respiratory tract and an air-purifying device or breathing air source, or both. It may be a facepiece, helmet, hood, suit, or a mouthpiece respirator with nose clamp.

Self-contained Breathing Apparatus (SCBA)

An atmosphere-supplying respirator for which the breathing air source is designed to be carried by the user.

Service Life

The period of time that a respirator, filter or sorbent, or other respiratory equipment provides adequate protection to the wearer.

Supplied-air Respirator (SAR) or Airline Respirator

An atmosphere-supplying respirator for which the source of breathing air is not designed to be carried by the user.

Tight-fitting Face piece

A respiratory inlet covering that forms a complete seal with the face.

User Seal Check

An action conducted by the respirator user to determine if the respirator is properly seated to the face.

Attachment B Seal Check Procedures

A seal check is required each time a respirator is worn, prior to entering the respirator use area. The purpose of a seal check is to make sure the respirator (which has been previously fit tested) is properly positioned to prevent leakage during use and to detect functional problems.

The procedure below has two parts; a positive pressure check and a negative pressure check. Both checks must be completed each time the respirator is worn. The checks are simple and should only take a few seconds to perform.

If the respirator does not pass both seal checks it is not functioning properly and the employee should notify his/her supervisor for further instruction.

Positive Pressure Check:

1. Remove exhalation valve cover, if removable.
2. Cover the exhalation valve completely with a palm of a hand while exhaling gently to inflate the facepiece slightly.
3. The respirator facepiece should remain inflated (indicating a build-up of positive pressure and no outward leakage).
 - If no leakage is detected, replace the exhalation cover (if removed), and proceed to conduct the negative pressure check.
 - If leakage is detected, reposition the respirator (after removal and inspection), and try the positive pressure check again.

Negative Pressure Check

1. Completely cover the inhalation opening(s) on the cartridges or canister with palm(s) of hand(s) while inhaling gently to collapse the facepiece slightly. If palms of hands are ineffective, filter seals (if available) or thin rubber gloves may be used.
2. Once the facepiece is collapsed, do not exhale for ten seconds while keeping the inhalation openings covered.
3. The facepiece should remain slightly collapsed (indicating negative pressure and no inward leakage).
 - If no leakage is detected, the tightness of the facepiece is considered adequate, the procedure is completed, and the respirator may be worn.
 - If leakage is detected, reposition the respirator (after removal and inspection) and repeat both the positive and negative seal checks.
4. If it is not possible to obtain a leak-free fit, it is necessary to try other sizes and styles of respirators.

Attachment C
Synopsis of County Fit Testing Procedures

QUALITATIVE FIT TESTS PROCEDURES

A. SOLUTION PREPARATION:

1. Unscrew the solution well and squeeze bulb of the nebulizer marked #1 Sensitivity Test Solution from the top portion and pour one teaspoon of the sensitivity test solution into the solution well.
2. Unscrew the solution well and squeeze bulb of the nebulizer marked #2 Fit Test Solution from the top portion and pour one teaspoonful of the fit test solution into the solution well.

B. SENSITIVITY TEST: With Nebulizer #1

This qualitative test is done to assure that the person being fit tested can detect the taste of the test solution at very low levels. The sensitivity is a very dilute version of the fit test solution. The subject should not consume anything orally for at least 15 minutes before the test.

1. Put hood on subject without wearing the respirator. Position hood with about six inches between subjects face and hood window.
2. Instruct subject to breathe through his or her mouth and notify you when he or she detects the bitter or sweet taste of the solution.
3. Remove vent plug and nozzle plug. Insert nebulizer through hole in window. Inject 10 squeezes or until the subject is able to taste compound, fully collapsing bulb on each squeeze.
4. Note the number of squeezes when the subject tastes the compound, since this number will be repeated during the actual fit test.

C. FIT TEST: With Nebulizer #2

1. Have subject don (put on) respirator and perform user seal check.
2. Wear respirator in uncontaminated area for a few minutes to make sure it is comfortable. Put on and position hood.
3. Put Nebulizer #2 through hole in hood window. Inject aerosol using same number of squeezes noted during the sensitivity testing.
4. After aerosol is injected, ask subject to perform following exercises, each for 60 seconds:
 - Normal Breathing (Standing upright)
 - Deep Breathing
 - Turning Head Side to Side, breathing at each shoulder
 - Move Head up and Down
 - Speak out Loud the "Rainbow Passage"

- Bend at Waist
 - Normal Breathing (while standing upright)
5. Replenish the aerosol concentration every 30 seconds using one half of the original number of squeezes.
 6. If entire test is completed without the subject detecting the taste, the test is successful and fit is deemed adequate.
 7. If subject exhibits difficulty in breathing during the tests, he or she will be referred to a physician or other licensed health care professional to determine whether the subject can wear a respirator while performing his or her duties.
 8. Record the test subject's name, respirator type and size, and date tested in a log.

**Attachment D
Respirator Fit Record**

Employee Information

Employee Name: _____

Department: _____ Supervisor: _____

Job Title: _____ Date of Fit Test: _____

Fit Test Information

Conditions observed at the time of fit test that could affect the respirator fit:

Glasses Facial Scar	Y / N Y / N	Additional Notes:
Clean Shaven	Y / N	
1-2 Day Growth	Y / N	
2+ Day Growth	Y / N	
Mustache	Y / N	
Does subject wear dentures?	Y / N	
If yes, are dentures present for fit test?	Y / N	

Respirator Type (Make/Model/Size)	
Testing Method	
Positive Pressure Fit Check	___ Pass ___ Fail
Negative Pressure Fit Check	___ Pass ___ Fail
Normal Breathing	___ Pass ___ Fail
Deep Breathing	___ Pass ___ Fail
Head Turn Side to Side	___ Pass ___ Fail
Head Moving Up and Down	___ Pass ___ Fail
Talking (Rainbow Passage)	___ Pass ___ Fail
Grimace	___ Pass ___ Fail
Bending Over	___ Pass ___ Fail
Normal Breathing	___ Pass ___ Fail

Based on information provided on this form, I certify that the employee named on this form can wear the respiratory protective equipment listed above.

Name of Person Administering Test: _____

Date of Administration: _____

Signature of Person Administering Test: _____



County of El Dorado, California

Regulatory Compliance Program No. 18 Trenching and Excavation Safety

I. Purpose

The objective of the Trenching and Excavation Safety Program (TESP) is to establish requirements for practices and procedures to protect employees when working in trenches and excavations. To assure compliance with the California Code of Regulations, including Title 8, §§ 1539-1542, this regulatory compliance program (RCP) provides guidance to managers, supervisors, and employees of the County of El Dorado (County) required to work in and/or around trenches and excavations.

II. Responsibilities

A. Department and/or division managers are responsible for:

1. Implementing the TESP throughout their departments;
2. Requesting help from Human Resources Department - Risk Management Division (Risk Management) staff to study specific operations, facilities, and equipment to determine employee exposure as needed;
3. Using engineering and/or administrative controls to reduce exposure to excavation hazards as required;
4. Implementing specific worksite procedures for the use of protective devices in accordance with this TESP;
5. Providing access to the regulations to all employees who are subject to the TESP;
6. Assuring that soil conditions are evaluated by a competent person before the start of work, daily, and throughout the job as conditions change; and
7. Maintaining records of the excavation checklist for a minimum of three (3) years.

B. Competent persons are responsible for:

1. Knowledge of the provisions pertaining to excavations, trenches, and earthwork;
2. Knowledge of soil analysis as related to excavations, trenches, and earthwork;
3. Knowledge of the use of protective systems;
4. Implementation of prompt corrective action on the job as conditions warrant;
5. Recognition of the potential and testing for hazardous atmospheres; and
6. Inspection of trenches and excavations before the start of work, daily, and throughout the day as conditions change.

C. Supervisors are responsible for:

1. Implementing the TESP within their work group;
2. Assuring access to protective devices as deemed necessary by the competent person;
3. Assuring that soil classification is performed;
4. Assisting in selection of protective equipment;

5. Conducting evaluations of the workplace to ensure that the written TESP is being properly implemented;
 6. Monitoring employees to ensure that they are using proper protective devices when necessary;
 7. Assuring proper documentation of inspections (Attachment A); and
 8. Assuring that training on trenching and excavation safety is provided to all exposed employees.
- D. Site supervisors/lead workers are responsible for:
1. Implementing TESP at the site;
 2. Assuring that soil classification is performed;
 3. Assuring appropriate protective devices are utilized according to design;
 4. Assuring that an "excavation competent person" is designated; and
 5. Assisting in providing training on trenching and excavationsafety.
- E. Excavation competent persons are responsible for:
1. Identifying existing and predictable hazards in the surroundings or working conditions which are unsanitary, hazardous, or dangerous to employees;
 2. Taking prompt corrective measures to eliminate them;
 3. Knowing excavation safety standards including soil classification;
 4. Knowing the proper use of protective systems and trench safety equipment; and
 5. Documenting their experience and training.
- F. Employees are responsible for:
1. Working in compliance with the TESP; and
 2. Never entering an excavation meeting the scope of this program until authorized by the competent person.
- G. Risk Management is responsible for :
1. Assisting in atmospheric testing and equipment selection, as needed;
 2. Assisting in protection equipment selection;
 3. Providing onsite evaluation to monitor use of safe work practices and procedures; and
 4. Reviewing and updating the TESP.

III. Procedures

A. Utilities

Utilities must be located at least two days prior to excavation. Excavations must not endanger the underground installations or the employees engaged in the work. Utilities left in place should be protected by barricades, shoring, suspension, or other means as

necessary to protect employees. In the event that County personnel discover or cause damage to subsurface installations, site personnel will immediately call emergency services (911), the owner of the installation, and County Risk Management.

B. Public Access

Excavations must be isolated from public access by substantial physical barrier. Barricades, lighting, and posting shall be installed as needed prior to the start of excavation operations. All temporary excavations shall be backfilled as soon as possible.

Guardrails, fences, or barricades should be installed around excavations adjacent to walkways, roads, paths, or other traffic areas. Use of barricade tape alone is not a sufficient method of isolation when the excavation is unattended. Warning lights or other illumination shall be used as necessary for the safety of the public at night.

Wells, holes, pits, and similar excavations must be effectively barricaded and/or covered and posted if unattended. Walkways or bridges used by the general public, employees, or equipment to cross excavations must be equipped with standard guardrails with the vertical height of the top rail within the range of 42 to 45 inches.

C. Surface Encumbrances

All equipment, materials, supplies, buildings, roadways, trees, utility vaults, boulders, etc. that could present a hazard to employees working in the excavation must be removed or supported as necessary to protect employees.

D. Soil Classification

The competent person in charge of the excavation is responsible for determining the soil type. All previously disturbed soil is automatically considered Type C soil. Soil may be classified as Type C by default and no additional tests are required. To classify a soil as Type B the competent person shall use a visual test coupled with one or more manual tests as described in Attachment B.

E. Protective Systems

Each employee required to work in an excavation of five (5) feet deep or more must be protected from cave-ins by shoring and/or sloping. Excavations of less than five (5) feet in depth are excluded from this requirement only if they are in solid rock or a competent person has inspected and finds no indication of a potential cave-in. If there is a possibility of soil movement, protective systems are required for trenches and excavation of less than five (5) feet. Acceptable protective methods include sloping, benching, shielding, and shoring. Excavations under the base of the footing for a foundation or wall, or greater than twenty (20) feet in depth, require support systems designed by a registered professional engineer.

Sidewalks, pavement, utility vaults, or other similar structures shall not be undermined unless a support system or another method of protection is provided to protect employees from possible collapse. Sloping or benching are often preferred methods of protection; however, shoring or shielding can be used when the location of the excavation makes sloping or benching to the allowable angle impractical. See Attachment C for commonly used examples of sloping and benching protective systems. For detailed information refer to Requirements for Protective Systems in Title 8, Section 1541.1 of the California Code of

Regulations (T8 CCR 1541.1), including Appendices A through F.

Sloping

Maximum allowable slopes for excavations of less than twenty (20) feet are based on soil type and angle to the horizontal are as follows:

- Stable Rock can have vertical walls with an angle of 90-degrees.
- Type A soil must have walls sloped to a maximum angle of 53-degrees (0.75:1 slope) from horizontal in all directions.
- Type B soil must have walls sloped to a maximum angle of 45-degrees (1:1 slope) from horizontal in all directions.
- Type C soil must have walls sloped to a maximum angle of 34-degrees (1.5:1 slope) from horizontal in all directions.
- (See Attachment C, Figures 1 & 2 for examples).

Shielding

Trench boxes or trench shields are intended to protect workers from cave-ins and similar incidents. The trench shield is lowered into the excavation and workers may then enter only the protected area within the shield. When shielding is used in conjunction with sloping, the shielding must extend a minimum of 18 inches above the top vertical side. (See Attachment C, Figure 4 for examples).

On vertical cut trenches the shielding must extend to at least the top of the excavation. As much as two feet of earth material can extend below the shielding, only if the shield is designed to resist the forces calculated for the full depth of the trench, and there are no indications while the trench is open of a possible loss of soil from behind or below the bottom of the shield.

F. Access and Egress

Structural ramps that are used solely by employees as a means of access or egress from excavations shall be designed by a competent person. Structural ramps used for access or egress of equipment shall be designed by a competent person qualified in structural design and shall be constructed in accordance with the design.

Means of safe egress from trench excavations such as a stairway, ladder, or ramp shall be located in trench excavations that are four (4) feet or more in depth at a frequency that requires no more than twenty-five (25) feet of lateral travel for all employees.

G. Adjacent Structures

Where the stability of adjoining buildings, walls, sidewalks, or other structures are endangered by excavation operations, support systems such as shoring, bracing, or underpinning shall be provided. Undermining the surface of adjacent structures without an engineered support system is prohibited.

H. Subsurface Installations

Hand excavation only is required within two (2) feet of subsurface installations in order to determine the exact location of the installation before using any power-operated or power-

driven excavating or boring equipment, except for the removal of any existing pavement if there are no subsurface installations contained in the pavement.

I. High Priority Subsurface Installations

When the excavation is proposed within ten (10) feet of a high priority subsurface installation, an onsite meeting is required between the excavator and the subsurface installation owner/operator's representative at a mutually agreed upon time to determine the action or activities required to verify the location of such installations. High priority subsurface installations include high pressure natural gas lines, petroleum pipelines, pressurized sewage pipelines, conductors or cables that have a potential to ground of 60,000 volts or more, or pipelines that are potentially hazardous to employees, or the public, if damaged.

J. Loose Rock or Soil

Employees shall be protected from loose rock or soil that could pose a hazard by falling or rolling from the excavation face. Such protection shall consist of scaling to remove loose material and/or installation of protective barricades at necessary intervals along the face to stop and contain falling material. Other means that provide equivalent protection are also acceptable.

Employees shall be protected from excavated materials or equipment that could pose a hazard by falling or rolling into excavations. Protection shall be provided by placing and keeping such materials or equipment at least two (2) feet from the edge of excavations or by the use of retaining devices that are sufficient to prevent materials or equipment from falling or rolling into excavations.

K. Hazardous Atmosphere

Where oxygen deficiency (atmospheres containing less than 19.5% oxygen) or a hazardous atmosphere exists or could reasonably be expected to exist, the atmosphere inside the excavation shall be tested before employees enter excavations greater than four (4) feet in depth. Atmospheric monitoring will be conducted in accordance with the County's Confined Space Entry Program, Regulatory Compliance Program No. 6. Adequate precautions shall be taken to prevent employee exposure to hazardous atmospheres including ventilation and/or respiratory protection. When a hazardous atmosphere exists or may be reasonably expected to develop, operations will be conducted as permit-required confined space entries in addition to compliance with excavation requirements.

L. Water Accumulation

Employees shall not work in excavations in which there is accumulated water or in excavations in which water is accumulating, unless adequate protective precautions are taken. The precautions may include support or shield systems, water removal procedures, or use of safety harness and lifeline. Water removal equipment and operations shall be monitored by a competent person.

M. Vehicle and Equipment Hazards

Employees exposed to vehicular traffic shall be provided with, and shall wear, warning vests or other suitable garments marked with or made of reflectorized or high-visibility material.

Employee shall not be permitted underneath loads handled by lifting or digging equipment. Employees shall be required to stand away from any vehicle being loaded or unloaded to avoid being struck by any spillage or falling materials.

Operators may remain in the cabs of vehicles being loaded or unloaded when the vehicles are equipped, in accordance with Title 8, Section 1591(e) of the California Code of Regulations, to provide adequate protection for the operator during loading and unloading operations.

When mobile equipment is operated adjacent to an excavation, or when such equipment is required to approach the edge of an excavation and the operator does not have a clear and direct view of the edge of the excavation, a warning system shall be utilized such as barricades, hand or mechanical signals or stop logs. If possible, the grade should be away from the excavation.

N. Inspections

Excavations, areas adjacent to excavations, and protective systems shall be inspected daily by a competent person for circumstances that could result in possible cave-ins, indications of failure of protective systems, hazardous atmospheres, or other hazardous conditions. An inspection shall be conducted by the competent person prior to the start of work and as needed throughout the shift.

Inspections shall also be made after every rain storm or other hazard increasing occurrence. These inspections are only required when employee exposure can be reasonably anticipated. Where the competent person finds evidence of a situation that could result in a possible cave-in, indications of failure of protective systems, hazardous atmospheres, or other hazardous conditions, exposed employees shall be removed from the hazardous area until the necessary precautions have been taken to ensure their safety.

O. Personal Protective Equipment

Employees who are working in or around excavations shall wear the following personal protective equipment at a minimum:

- ANSI 107 compliant Class 2 or higher high visibility clothing.
- ANSI Z-89 compliant hard hat.
- ANSI Z-87 compliant safety glasses.
- Approved work uniform.

IV. Training

Employees will be trained in the hazards of working in and around excavations prior to exposure and periodically if work practices change. All supervisors and site supervisors will be trained and qualified as excavation competent persons.

V. Recordkeeping

A. Written Program

Update and maintain TESP in accordance with applicable regulations and industry best practices.

B. Excavation Checklists and Inspections

Maintain records for three years.

C. Employee Training Records

Maintain records for duration of employment plus three years.

VI. Program Evaluation

Risk Management will evaluate and update the TESP annually in partnership with department safety coordinators.

**Attachment A
Daily Trench / Excavation Inspection Form**

In accordance with Cal/OSHA regulations, trenches/excavations are to be inspected for hazardous conditions prior to entry and continuously throughout the work by a competent person. The competent person must inspect the following items and sign that the inspection has been completed. Make comments as appropriate and retain inspection form on file for three years. If there is a deficiency, inform your supervisor immediately. Work is not to proceed until the hazardous condition is mitigated or controlled.

Project: _____ Department: _____

Date: _____ Time: _____ Weather: _____

Soil Type: _____ Trench Depth: _____ Length: _____ Width: _____

Type of Protective System: _____

Utilities	Yes	No	N/A	Comments
Utility companies contacted and/or utilities located.				
Exact location of utilities marked when near excavation.				
Prior to use of equipment, underground utilities have been located by hand digging.				
Underground installations protected, supported or removed when excavation is open.				
Excavation	Yes	No	N/A	Comments
Is excavation less than five feet in depth?				
Is there a potential for a cave-in? (If YES, excavation must be sloped, shored or shielded)				
Is excavation five feet or deeper than five feet in depth?				
Is sloping used as your protective system?				
Excavations, adjacent areas & protective systems inspected by Competent Person daily and before the start of work.				
Competent person has authority to remove workers from excavation immediately.				

Surface encumbrances supported or removed.				
Employees protected from loose rock or soil.				
Hard hats and safety glasses worn by all employees.				
Spoils, materials and equipment set back a minimum of two (2) feet from edge of excavation.				
Adequate barriers provided at all excavations, wells, pits, shafts, etc.				
Walkways and bridges over excavations six (6) feet or more in depth and more than thirty (30) inches wide equipped with guardrails.				
High visibility clothing worn by all employees.				
Employees prohibited from working or walking under suspended loads or booms.				
Employees required to stand away from vehicles being loaded or unloaded.				
Employees prohibited from working on faces of sloped or benched excavations above other employees.				
Warning system established and used when mobile equipment is operating near edge of excavation.				
Emergency Action Plan established and communicated to crew.				
Means of Access and Egress:	Yes	No	N/A	Comments
Travel distance to means of egress no greater than 25 feet in excavations four (4) feet or more in depth.				
Straight ladders used in excavations extend at least three (3) feet above the edge of trench				
Ramps being used by the employee access have been designed by competent person.				
Employees protected from cave-ins when entering or exiting the excavation.				
Wet Conditions	Yes	No	N/A	Comments
Precautions taken to protect employees from water accumulation.				
Water removal equipment monitored by competent person.				
Surface water or runoff controlled or diverted to prevent accumulation in excavation.				
Inspection made by competent person after each rainstorm or other hazard-increasing occurrence.				

Hazardous Atmosphere	Yes	No	N/A	Comments
Atmosphere tested when there is a possibility of oxygen deficiency or build-up of hazardous gases.				
a. Are there exposed sewer or natural gas lines in excavation?				
b. Is excavation near a landfill area, or are hazardous substances being stored close to the excavation?				
If you answered YES to A or B, then treat excavation as a confined space and refer to table below and RCP #6 (Confined Spaces).				
Oxygen between 19.5 % and 21%.				
Ventilation provided to prevent flammable gas build-up to 20% of lower explosive limit of the gas.				
Continuous testing conducted to ensure that atmosphere remains safe.				
Emergency response equipment readily available where a hazardous atmosphere could or does exist.				
Employees trained in the use of personal protective and emergency response equipment.				
Safety harness and life line individually attended when employees enter deep confined excavations.				
Support Systems	Yes	No	N/A	Comments
Materials and/or equipment for support systems selected based on soil analysis, trench depth, and expected loads.				
Materials and equipment used for protective systems inspected and in good condition.				
Materials and equipment not in good condition have been removed from service.				
Protective systems installed without exposing employees to the hazards of cave-ins, collapses, or threat of being struck by materials or equipment.				
Members of support system securely fastened to prevent failure.				
Support systems provided to ensure stability of adjacent structures, buildings, roadways, sidewalks, walls, etc.				
Excavations below the level of the base of a footing have been approved by a Registered Professional Engineer.				

Removal of support systems progresses from the bottom and members are released slowly so you can note any indication of possible failure.				
Backfilling progresses with removal of support system.				
Excavation of material to a level no greater than two (2) below the bottom of the support system and only if system is designed to support the loads calculated for the full depth.				
Shield system placed to prevent lateral movement.				
Employees are prohibited from remaining in shield system during vertical movement.				

TIME	REQUIRED TESTS OF AIR IN THE CONFINED SPACE						TIME	REQUIRED TESTS OF AIR IN THE CONFINED SPACE					
	LEL %	OXY %	H ₂ S PPM	CO PPM	OTHER ¹			LEL %	OXY %	H ₂ S PPM	CO PPM	OTHER	
					PPM	PPM						PPM	PPM
No entry when levels are: Call the SAFETY OFFICE	10	<19.5 >23.5	>10	>25				10	<19.5 >23.5	>10	>25		

Training	Yes	No	N/A	Comments
All employees have received excavation safety awareness training.				

Name of Competent Person
(print)

Signature of Competent Person

Date

Attachment B

Soil Classification Requirements

Definitions

Cemented soil

A soil in which the particles are held together by a chemical agent, such as calcium carbonate, such that a hand-size sample cannot be crushed into powder or individual soil particles by finger pressure.

Cohesive soil

Clay (fine grained soil), or soil with a high clay content, which has cohesive strength. Cohesive soil does not crumble, can be excavated with vertical side slopes, and is plastic when moist. Cohesive soil is hard to break up when dry, and exhibits significant cohesion when submerged.

Cohesive soils include clayey silt, sandy clay, silty clay, clay and organic clay. Dry soil: Soil that does not exhibit visible signs of moisture content.

Fissured soil

A soil material that has a tendency to break along definite planes of fracture with little resistance, or a material that exhibits open cracks, such as tension cracks, in an exposed surface.

Granular soil

A gravel, sand, or silt (coarse grained soil) with little or no clay content. Granular soil has no cohesive strength. Some moist granular soils exhibit apparent cohesion. Granular soil cannot be molded when moist and crumbles easily when dry.

Layered system

Two or more distinctly different soil or rock types arranged in layers. Micaceous seams or weakened planes in rock or shale are considered layered.

Moist soil

A condition in which a soil looks and feels damp. Moist cohesive soil can easily be shaped into a ball and rolled into small diameter threads before crumbling. Moist granular soil that contains some cohesive material will exhibit signs of cohesion between particles.

Plastic

A property of a soil which allows the soil to be deformed or molded without cracking, or appreciable volume change.

Saturated soil

A soil in which the voids are filled with water. Saturation does not require flow. Saturation, or near saturation, is necessary for the proper use of instruments such as a pocket penetrometer or shear vane.

Soil classification system

A method of categorizing soil and rock deposits in a hierarchy of Stable Rock, Type A, Type B, and Type C, in decreasing order of stability. The categories are determined based on an analysis of the properties and performance characteristics of the deposits and the characteristics of the deposits and the environmental conditions of exposure.

Stable rock

Natural solid mineral matter that can be excavated with vertical sides and remain intact while exposed.

Submerged soil

Soil which is underwater or is free seeping.

Type A soil

Cohesive soils with an unconfined, compressive strength of 1.5 tons per square foot (tsf) or greater. Examples of cohesive soils are as follows: clay, silty clay, sandy clay, clay loam and, in some cases, silty clay loam and sandy clay loam. Cemented soils such as caliche and hardpan are also considered Type A. However, no soil is Type A if:

- The soil is fissured; or
- The soil is subject to vibration from heavy traffic, pile driving, or similar effects; or
- The soil has been previously disturbed; or
- The soil is part of a sloped, layered system where the layers dip into the excavation on a slope of four horizontal to one vertical (4H:1V) or greater; or
- The material is subject to other factors that would require it to be classified as a less stable material.

Type B soil

- Cohesive soil with an unconfined compressive strength greater than 0.5 tsf but less than 1.5 tsf; or
- Granular cohesionless soils including: angular gravel (similar to crushed rock), silt, silt loam, sandy loam and, in some cases, silty clay loam and sandy clay loam; or
- Previously disturbed soils except those which would otherwise be classed as Type C soil; or
- Soil that meets the unconfined compressive strength or cementation requirements for Type A, but is fissured or subject to vibration; or
- Dry rock that is not stable; or
- Material that is part of a sloped, layered system where the layers dip into the excavation on a slope less steep than four horizontal to one vertical (4H:1V), but only if the material would otherwise be classified as Type B.

Type C soil

- Cohesive soil with an unconfined compressive strength of 0.5 tsf or less; or
- Granular soils including gravel, sand, and loamy sand; or
- Submerged soil or soil from which water is freely seeping; or
- Submerged rock that is not stable, or
- Material in a sloped, layered system where the layers dip into the excavation on a slope of four horizontal to one vertical (4H:1V) or steeper.

Unconfined compressive strength: The load per unit area at which a soil will fail in compression. It can be determined by laboratory testing, or estimated in the field using a pocket penetrometer, by thumb penetration tests, and other methods.

Wet soil: Soil that contains significantly more moisture than moist soil, but in such a range of values that cohesive material will slump or begin to flow when vibrated. Granular material that would exhibit cohesive properties when moist will lose those cohesive properties when wet.

Requirements

Classification of soil and rock deposits.

Each soil and rock deposit shall be classified by a competent person as Stable Rock, Type A, Type B, or Type C in accordance with the definitions set forth above.

Basis of classification

The classification of the deposits shall be made based on the results of at least one visual and at least one manual analysis. Such analyses shall be conducted by a competent person using tests

described in the acceptable visual and manual tests section below, or in other approved methods of soil classification and testing such as those adopted by the American Society for Testing Materials, or the U.S. Department of Agriculture textural classification system.

Visual and manual analyses

The visual and manual analyses, such as those noted as being acceptable in the visual and manual tests section of this appendix, shall be designed and conducted to provide sufficient quantitative and qualitative information as may be necessary to identify properly the properties, factors, and conditions affecting the classification of the deposits.

Layered systems

In a layered system, the system shall be classified in accordance with its weakest layer. However, each layer may be classified individually where a more stable layer lies under a less stable layer.

Reclassification

If, after classifying a deposit, the properties, factors, or conditions affecting its classification change in any way, the changes shall be evaluated by a competent person. The deposit shall be reclassified as necessary to reflect the changed circumstances.

Acceptable Visual and Manual Tests

Visual Tests

Visual analysis is conducted to determine qualitative information regarding the excavation site in general, the soil adjacent to the excavation, the soil forming the sides of the open excavation, and the soil taken as samples from excavated material.

- Observe samples of soil that are excavated and soil in the sides of the excavation. Estimate the range of particle sizes and the relative amounts of the particle sizes. Soil that is primarily composed of fine-grained material is cohesive material. Soil composed primarily of coarse-grained sand or gravel is granular material.
- Observe soil as it is excavated. Soil that remains in clumps when excavated is cohesive. Soil that breaks up easily and does not stay in clumps is granular.
- Observe the side of the opened excavation and the surface area adjacent to the excavation. Crack-like openings such as tension cracks could indicate fissured material. If chunks of soil spall off a vertical side, the soil could be fissured. Small spalls are evidence of moving ground and are indications of potentially hazardous situations.
- Observe the area adjacent to the excavation and the excavation itself for evidence of existing utility and other underground structures, and to identify previously disturbed soil.
- Observe the opened side of the excavation to identify layered systems. Examine layered systems to identify if the layers slope toward the excavation. Estimate the degree of slope of the layers.
- Observe the area adjacent to the excavation and the sides of the opened excavation for evidence of surface water, water seeping from the sides of the excavation, or the

location of the level of the water table.

- Observe the area adjacent to the excavation and the area within the excavation for sources of vibration that may affect the stability of the excavation face.

Manual tests

Manual analysis of soil samples is conducted to determine quantitative as well as qualitative properties of soil and to provide more information in order to classify soil properly.

- **PlastiCounty** - Mold a moist or wet sample of soil into a ball and attempt to roll it into threads as thin as 1/8-inch in diameter. Cohesive material can be successfully rolled into threads without crumbling. For example, if at least a two inch length of 1/8-inch thread can be held on one end without tearing, the soil is cohesive.
- **Dry Strength** - If the soil is dry and crumbles on its own or with moderate pressure into individual grains or fine powder, it is granular (any combination of gravel, sand, or silt). If the soil is dry and falls into clumps which break up into smaller clumps, but the smaller clumps can only be broken up with difficulty, it may be clay in any combination with gravel, sand or silt. If the dry soil breaks into clumps which do not break up into small clumps and which can only be broken with difficulty, and there is no visual indication the soil is fissured, the soil may be considered unfissured.
- **Thumb Penetration** - The thumb penetration test can be used to estimate the unconfined compressive strength of cohesive soils. Type A soils with an unconfined compressive strength of 1.5 tsf can be readily indented by the thumb; however, they can be penetrated by the thumb only with very great effort. Type C soils with an unconfined compressive strength of 0.5 tsf can be easily penetrated several inches by the thumb, and can be molded by light finger pressure. This test should be conducted on an undisturbed soil sample, such as a large clump of spoil, as soon as practicable after excavation to keep to a minimum the effects of exposure to drying influences (rain, flooding), the classification of the soil must be changed accordingly.
- **Other Strength Tests** - Estimates of unconfined compressive strength of soils can also be obtained by use of a pocket penetrometer or by using a hand-operated shearvane.
- **Drying Test** - The basic purpose of the drying test is to differentiate between cohesive material with fissures, unfissured cohesive material, and granular material. The procedure for the drying test involves drying a sample of soil that is approximately one inch thick and six inches in diameter until it is thoroughly dry.
 - If the sample develops cracks as it dries, significant fissures are indicated.
 - Samples that dry without cracking are to be broken by hand. If considerable force is necessary to break a sample, the soil has significant cohesive material content. The soil can be classified as an unfissured cohesive material and the unconfined compressive strength should be determined.
 - If a sample breaks easily by hand, it is either a fissured cohesive material or a granular material. To distinguish between the two, pulverize the dried clumps of the sample by hand or by stepping on them. If the clumps do not pulverize easily, the material is cohesive with fissures. If they pulverize easily into very small fragments, the material is granular.

Attachment C
Excavation Diagrams

Figure 1: Illustrations of simple slope trenching in A, B and C type soils

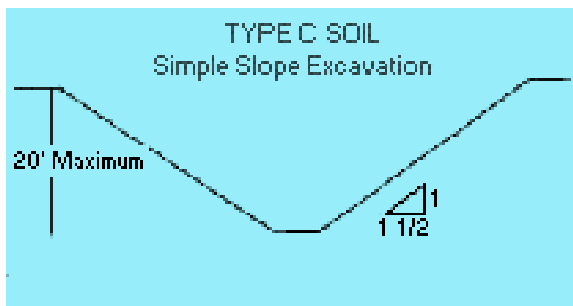
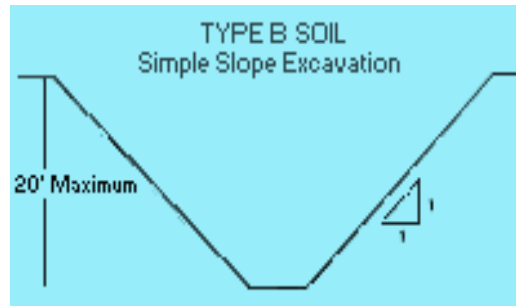
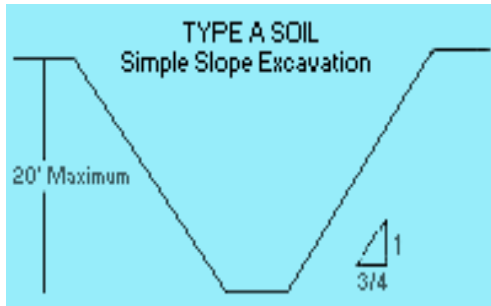

Figure 2: Illustrations of slope configurations in layered soils

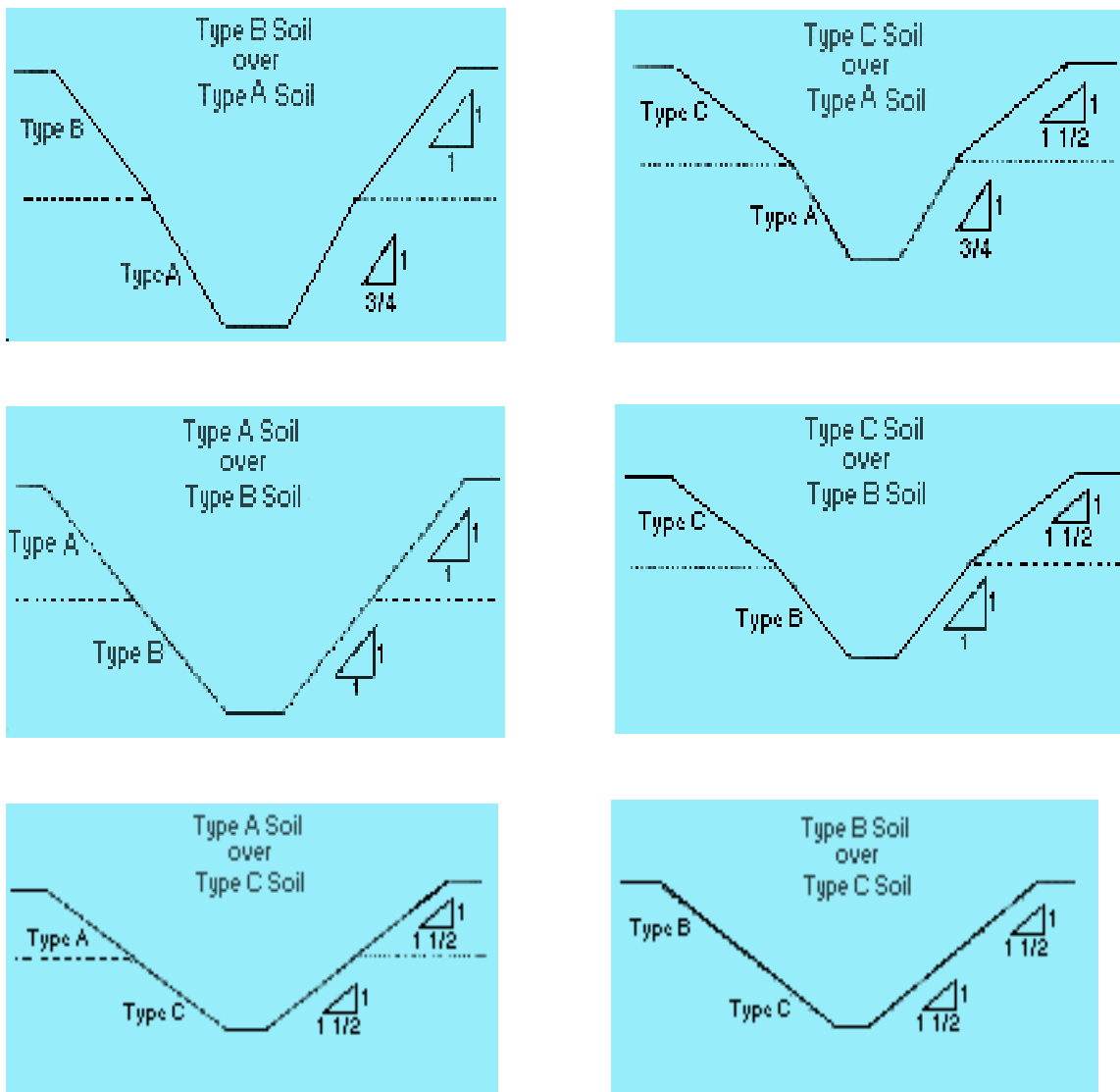

Figure 3: All benched excavations 20 feet or less in depth shall have a maximum allowable slope of 1:1. Benching is not allowed in type C soil.

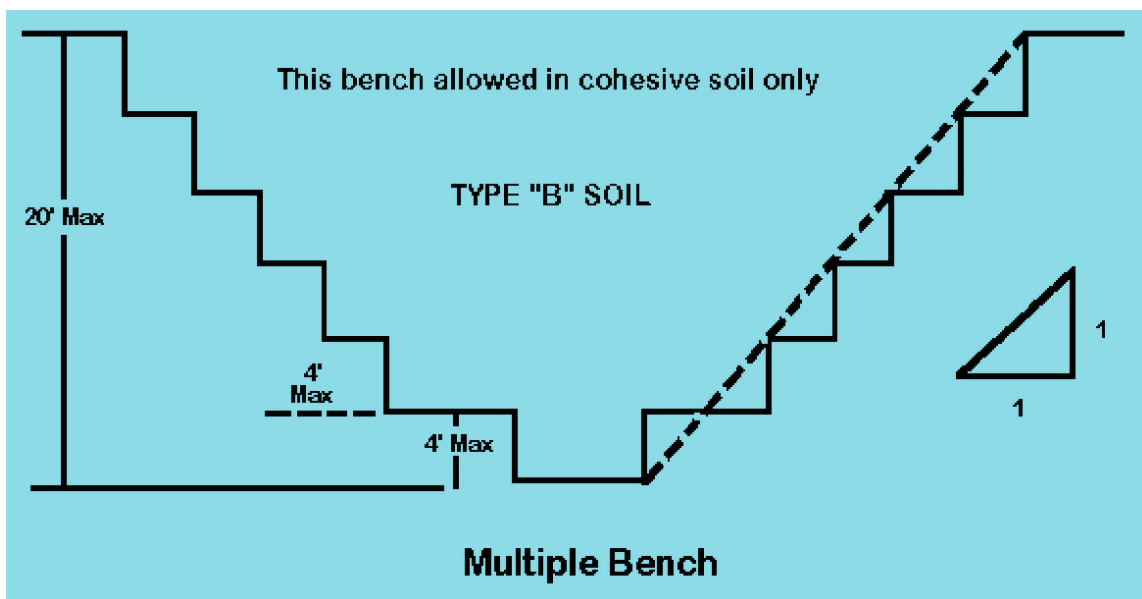
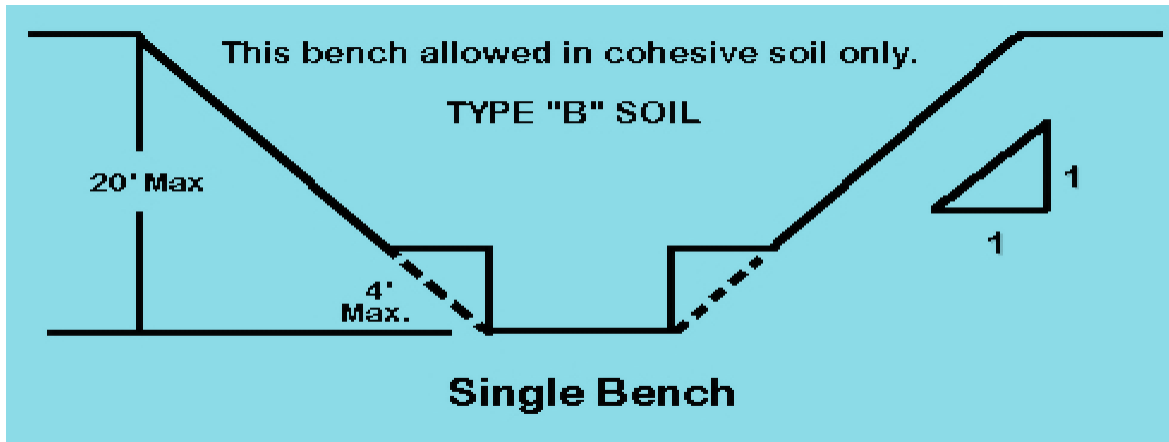

Figure 4: Illustrations of shielding systems in B and C type soils

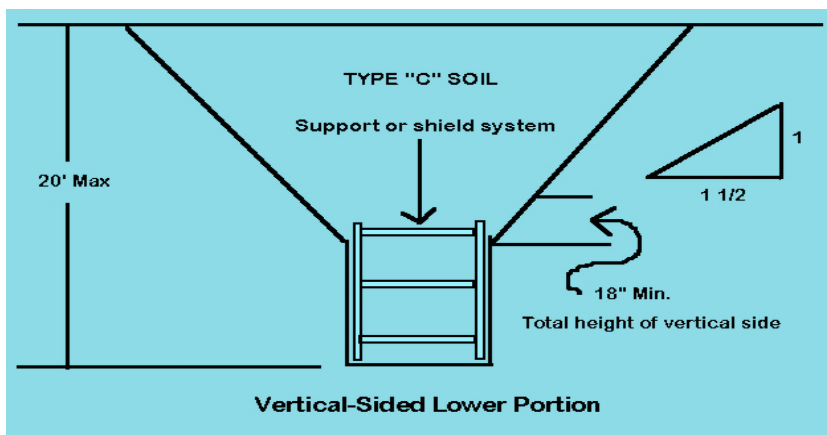
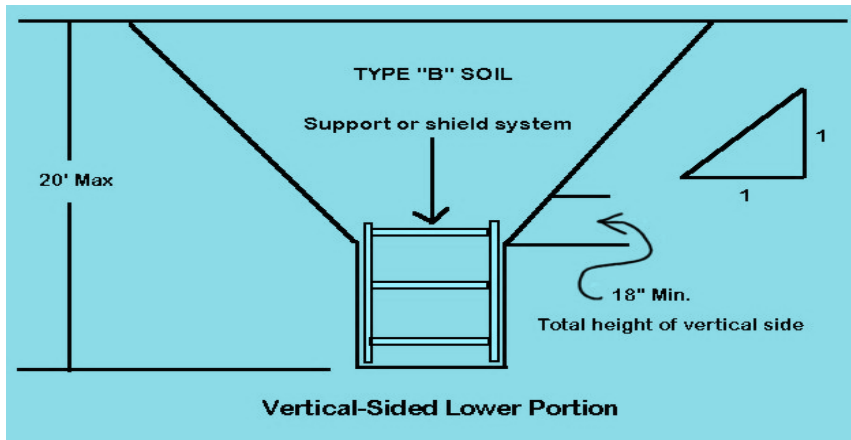
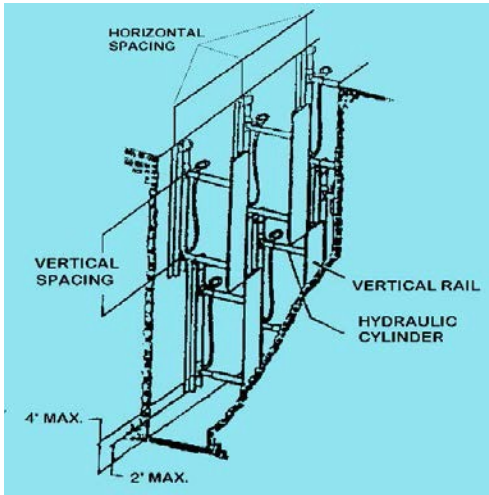
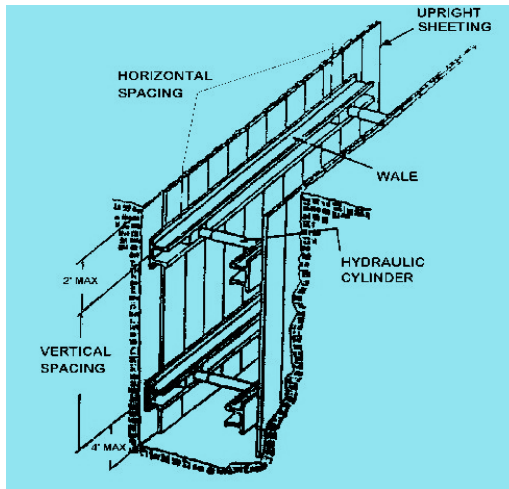

Figure 5: Illustrations of Aluminum hydraulic shoring systems



Vertical Stacked



Waler System