

# DIAMOND SPRINGS VILLAGE APARTMENTS

## CONCEPTUAL SITE PLAN

A PORTION OF THE SOUTH 1/2 OF SECTION 19 AND THE NORTH 1/2 OF SECTION 30, T10N, R11E, M2M.  
DIAMOND SPRINGS, EL DORADO COUNTY, CALIFORNIA  
OCTOBER, 2017 SCALE: 1" = 50'

SHEET	TITLE
AD.1	CONCEPTUAL SITE PLAN
AD.2	NEIGHBORHOOD PARCEL MAP
AD.3	VICINITY MAP
AT.1	1-BED FLOOR PLAN
AT.2	2-BED ELEVATIONS
AT.3	2-BED FLOOR/ROOF PLAN
AT.4	2-BED ELEVATIONS
AT.5	2-BED FLOOR/ROOF PLAN
AT.6	3-BED ELEVATIONS
AT.7	3-BED FLOOR/ROOF PLAN
AT.8	3-BED ELEVATIONS
AS.1	COMMUNITY FLOOR PLAN
AS.2	COMMUNITY ELEVATIONS

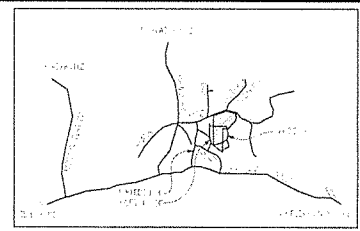

VICINITY MAP  
NO SCALE

PARKING REQUIRED				
No. UNITS	TYPE	RESIDENT	GUEST	REQUIRED
20	1-BRM	10	5	35
40	2-BRM	80	10	90
20	3-BRM	40	5	45
	OFFICE			4
60	MANAGE			174

PARKING PROVIDED	
STANDARD	122
COMPACT	61
COMPACT	7
MANAGE	12
TOTAL PROVIDED	182

MIN. PARKING SIZE	
STANDARD: 9' WIDE, 19' DEEP	
COMPACT: 9' WIDE, 10' DEEP	

BUILDING LEGEND	
COMMUNITY	
1-BEDROOM	
2-BEDROOM	
3-BEDROOM	
1-3-BEDROOM	

AREA CALCULATIONS	
AREA	50FT
CONDITIONED	78,401
PORCH/PATIO	5,859
STORAGE	3,624
LANDSCAPE	170
CURB AREA	132,294
SITE STORAGE	370

KEYNOTES	
1	12" DEEP, 96" WIDE, 40" HIGH SIGN
2	12" 6" REDWOOD FENCE TO REMAIN
3	PROPOSED 6" REDWOOD FENCE
4	18'-25" STORAGE SHED
5	PLAYGROUND CHILDREN AGES 2-12 (500 SF)
6	STEEL LAMP, NO FURNISH ALLOWED
7	PLAYGROUND CHILDREN AGES 13-17 (200 SF)

Exhibit F

PROJECT INFORMATION	
<b>OWNER / APPLICANT:</b> CONCEPT FOUNDATION 8603 GARDENIA LN, STE 324 ORANGE VILL, CA 92662 916-949-8883 CONTACT PERSON: SERGE OLESZAK	<b>GENERAL PLAN DESIGNATION:</b> MFA - MEDIUM DENSITY RESIDENTIAL MFR - MULTI-FAMILY RESIDENTIAL
<b>PLANNING &amp; ENGINEERING:</b> S20 PLANNING & ENGINEERING, INC. 140 LITTON DRIVE, SUITE 240 DREAS VALLEY, CA 95626 530-272-3641 CONTACT PERSON: MARTIN D. WOOD, P.L.S.	<b>FIRE PROTECTION:</b> EL DORADO COUNTY FIRE DISTRICT
<b>ARCHITECT:</b> JEALD & BOD, ARCHITECT CA LIC: C11902 916-223-9152	<b>WATER:</b> EL DORADO IRRIGATION DISTRICT
<b>ASSESSOR'S PARCEL:</b> 051-461-09	<b>ELECTRICAL &amp; GAS UTILITIES:</b> PACIFIC GAS & ELECTRIC
<b>LAND AREA:</b> 10.72 ACRES	<b>TELEPHONE:</b> AT&T
<b>ZONING:</b> DR	<b>SEWAGE DISPOSAL:</b> EL DORADO IRRIGATION DISTRICT
	<b>SCHOOL DISTRICT:</b> EL DORADO UNION

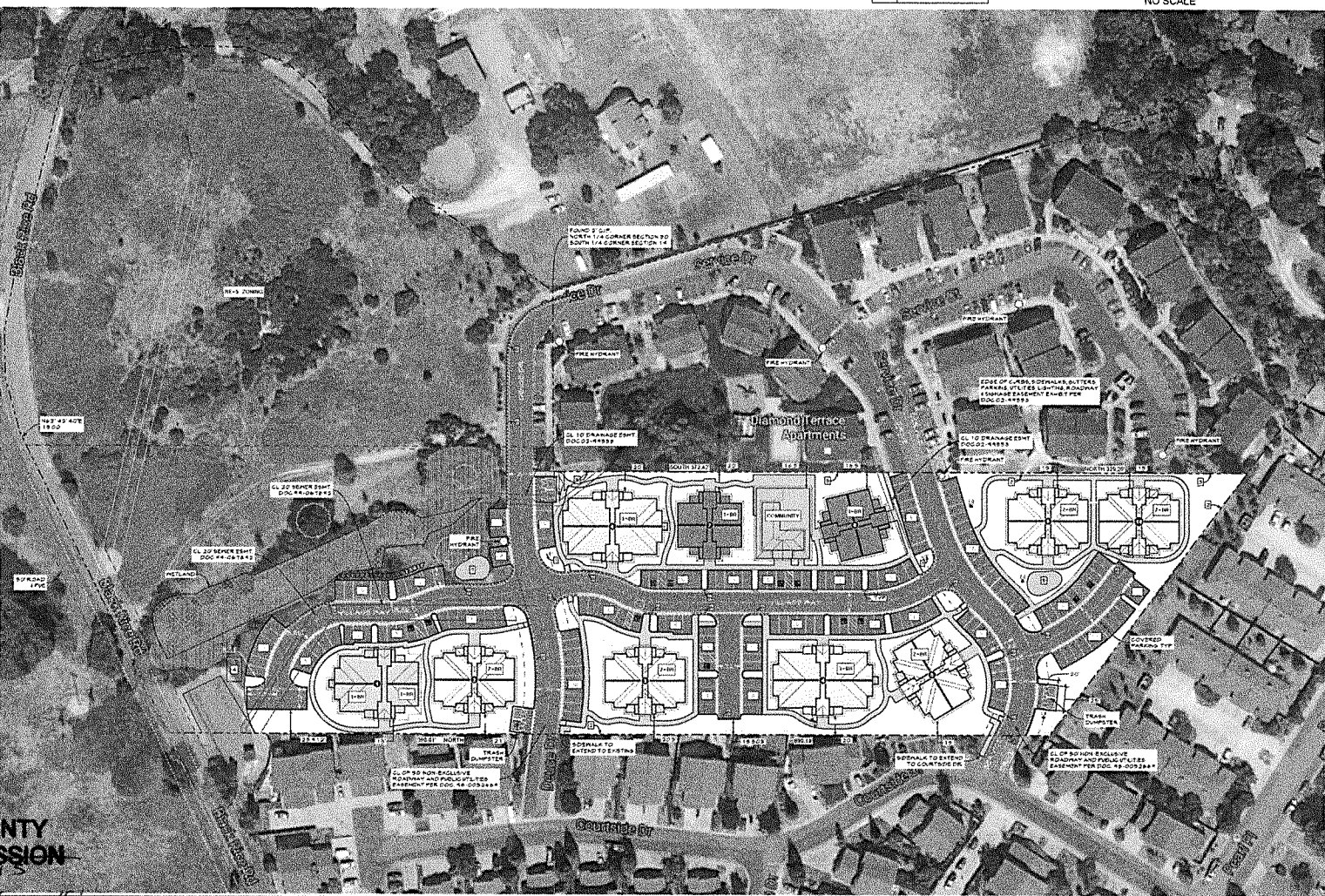

APPROVED  
EL DORADO COUNTY  
PLANNING COMMISSION  
Board of Supervisors

DATE: August 14, 2018

BY: *Roger Trond*  
EXECUTIVE SECRETARY

DIAMOND SPRINGS VILLAGE APARTMENTS  
CONCEPTUAL SITE

A0.1

EL DORADO COUNTY CALIFORNIA

# **DIAMOND SPRINGS VILLAGE APARTMENTS**

## **VICINITY MAP**

A PORTION OF THE SOUTH 1/2 OF SECTION 19 AND THE NORTH 1/2 OF SECTION 30, T10N, R11E, M2M.  
DIAMOND SPRINGS, EL DORADO COUNTY, CALIFORNIA  
OCTOBER, 2017 SCALE: 1" = 100'



DIAMOND SPRINGS VILLAGE APARTMENTS  
VICINITY MAP

A0.3

EL DORADO COUNTY

CALIFORNIA

DATE	NOV 14 2017
BY	...
FOR	...
PROJECT	DIAMOND SPRINGS VILLAGE APARTMENTS
SHEET NO.	...
TOTAL SHEETS	...

**DIAMOND SPRINGS VILLAGE APARTMENTS  
CONCEPTUAL SITE PLAN**

A PORTION OF THE SOUTH 1/2 OF SECTION 19 AND THE NORTH 1/2 OF SECTION 20, T10N, R11E, M2M,  
DIAMOND SPRINGS, EL DORADO COUNTY, CALIFORNIA  
MARCH, 2017 SCALE: N15



#	APN	Address	Owner
1	051-461-49-100	4541 April Ln Placerville, CA 95667	Ervin Scott and Ervin Garth B
2	051-461-22-100	6720 Easterly Ranch Rd Placerville, CA 95667	Nicolas Richard C and Nicolas Dorothy A
3	051-550-19-100	907 Black Rise Rd Placerville, CA 95667	Hansen Jerry Donohue Anne
4	051-550-33-100	900 Black Rise Rd, Placerville, CA 95667	Hansen Jerry S and Donohue Anne L
5	051-461-60-100	6035 Service Dr, Diamond Springs, CA 95619	DIAMOND TERRACE APARTMENTS
6	051-541-10-100	620 Pearl Pl, Diamond Springs, CA 95619	Link Allen and Link Keeley
7	051-541-09-100	626 Pearl Pl Diamond Springs, CA 95619	Link Allen and Link Keeley
8	051-541-08-100	634 Pearl Pl Diamond Springs, CA 95619	Leu Merlin R and Leu Ann L
9	051-541-07-100	642 Pearl Pl Diamond Springs, CA 95619	Weckworth Rodney R and Weckworth Helena J
10	051-670-05-100	3057 Courtside Dr, Diamond Springs, CA 95619	Barley William P Jr and Scharruhn Katharina
11	051-650-11-100		COURTSIDE MANOR HMOWNERS ASSOC
12	051-650-01-100	3041 Courtside Dr, Diamond Springs, CA 95619	Faria Tyler and Faria Kylie
13	051-650-02-100	3037 Courtside Dr, Diamond Springs, CA 95619	Nicolis Steven A and Nicolis Patricia C
14	051-650-03-100	3031 Courtside Dr, Diamond Springs, CA 95619	Fontaine Joshua D and Fontaine Volarie
15	051-650-04-100	3029 Courtside Dr, Diamond Springs, CA 95619	Cuevas Pedro and Cuevas Carmen Sanchez
16	051-650-05-100	3027 Courtside Dr, Diamond Springs, CA 95619	Richards Carson J and Willette Rayne B
17	051-650-06-100	3025 Courtside Dr, Diamond Springs, CA 95619	Turner Robert V
18	051-650-07-100	3023 Courtside Dr, Diamond Springs, CA 95619	Finley Honey and Finley Scott T
19	051-650-08-100	3021 Courtside Dr, Diamond Springs, CA 95619	Chiappone Thomas P and Chiappone Jennifer W
20	051-650-09-100	3019 Courtside Dr, Diamond Springs, CA 95619	Ivester Kimberly D and Ivester K D
21	051-650-10-100	3017 Courtside Dr, Diamond Springs, CA 95619	Hazlett Matthew D and Hazlett Tara D
22	051-670-05-100	3015 Courtside Dr, Diamond Springs, CA 95619	Minnick Larry S and Minnick Mary Anne
23	051-670-07-100	3013 Courtside Dr, Diamond Springs, CA 95619	James Robert B and James Mary R
24	051-670-08-100	3011 Courtside Dr, Diamond Springs, CA 95619	Ludwig Vicki Ann and Ludwig V
25	051-670-09-100	3009 Courtside Dr, Diamond Springs, CA 95619	Kaur Inderjit
26	051-670-51-100	3007 Courtside Dr, Diamond Springs, CA 95619	Chima Balkar S and Chima Ranjit K
27	051-670-52-100	3005 Courtside Dr, Diamond Springs, CA 95619	Keller Karen L
28	051-670-53-100	3003 Courtside Dr, Diamond Springs, CA 95619	Odlin David H
29	051-670-54-100	3001 Courtside Dr, Diamond Springs, CA 95619	Signor Benjamin J
30	051-670-55-100	2999 Courtside Dr, Diamond Springs, CA 95619	Elder Michael and Elder Sara



DIAMOND SPRINGS VILLAGE APARTMENTS  
NEIGHBORHOOD PARCEL MAP

EL DORADO COUNTY  
CALIFORNIA

A0.2

SQUARE FOOTAGE

UNFURNISHED - 6165 SF

FURNISHED - 6600 SF

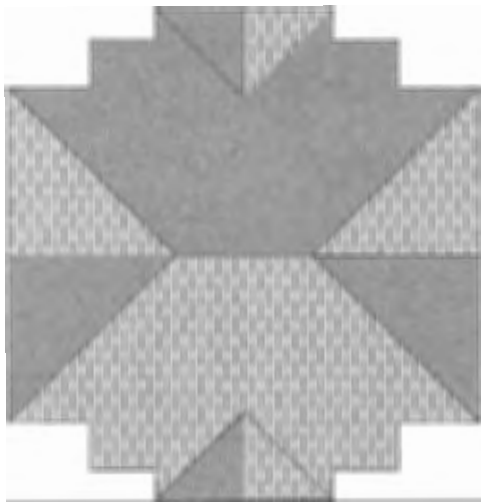

ROOF PLAN  
1/8" = 1'-0"

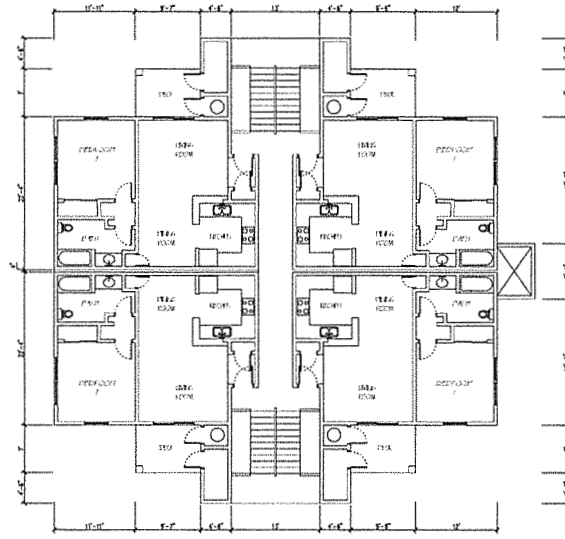

SECOND FLOOR PLAN  
1/8" = 1'-0"

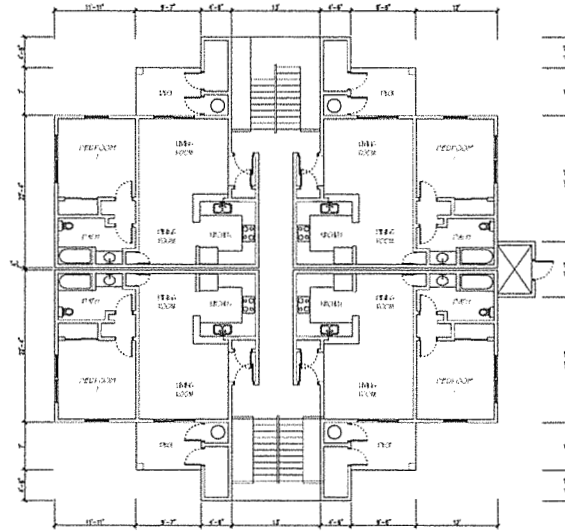

FIRST FLOOR PLAN  
1/8" = 1'-0"

SHEET <b>A1.1</b>	EL DORADO COUNTY	DIAMOND SPRINGS VILLAGE APARTMENTS FLOOR PLAN/ROOF PLAN 1 BEDROOM		NO. REVISIONS	DATE	DESIGNED BY DRAWN BY
		CALIFORNIA				PROJ. NO. 201714 DWG. SEC. 047 - SHMP DATE SEE DWG. STAMP

- TYPICAL EXTERIOR FINISHES**
1. GOMP ROOFING
  2. STUCCO WALL FINISH
  3. STONE VENER ACCENTS
  4. VINYL FRAME WINDOWS AND SLIDING DOORS
  5. COMPOSITE ENTRY DOORS
  6. FIBER CEMENT TRIMS AND FASCIAS
  7. METAL GUTTERS AND DOWNSPOUTS
  8. METAL HANDRAILS AND GUARDRAILS
  9. STEEL FRAME STAIRS / CONCRETE TREADS



FRONT ELEVATION



SIDE ELEVATION



REAR ELEVATION



OTHER SIDE ELEVATION

SHEET <b>A1.2</b>	<b>DIAMOND SPRINGS VILLAGE APARTMENTS</b> ARCHITECTURAL ELEVATIONS 1 BEDROOM-ELEVATIONS	NO. OF PAGES	DATE	DESIGNED BY FRANK LOR
				PROJECT NO. NC 201214
				DATE OF DRAWING DATE: SEE DAY STAMP

SQUARE FOOTAGE

1886-72A - 922 SF

DECK/PATIO - 400 SF

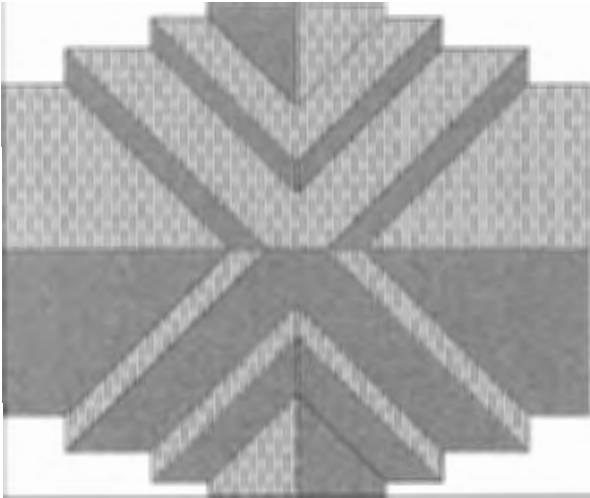

ROOF PLAN  
1/8" = 1'-0"

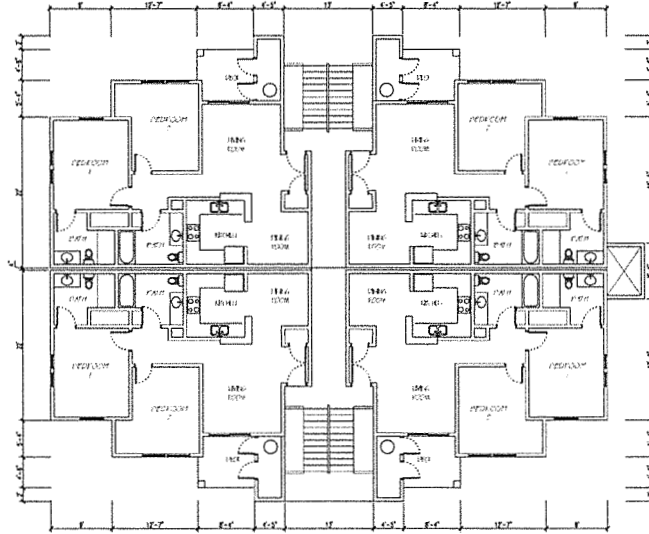

SECOND FLOOR PLAN  
1/8" = 1'-0"

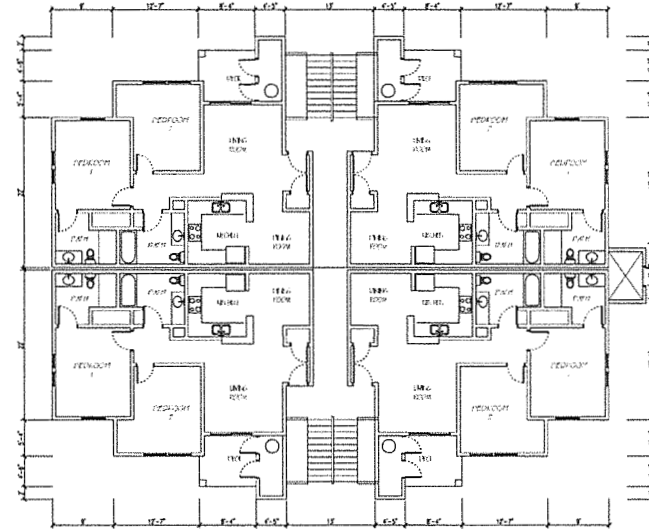

FIRST FLOOR PLAN  
1/8" = 1'-0"

DESIGNED BY	DATE
DRAWN BY	
PROJ. NO. 20214	
DWG. SET DAY STAMP	
DATE SET DAY STAMP	

NO. REVISIONS	DATE

**DIAMOND SPRINGS VILLAGE APARTMENTS**  
**FLOOR PLAN/ROOF PLAN**  
 2 BEDROOM  
 CALIFORNIA  
 EL DORADO COUNTY

SHEET  
**A2.1**

- TYPICAL EXTERIOR FINISHES**
1. COMP ROOFING
  2. STUCCO WALL FINISH
  3. STONE VENEER ACCENTS
  4. VINYL FRAME WINDOWS AND SLIDING DOORS
  5. COMPOSITE ENTRY DOORS
  6. FIBER CEMENT TRIMS AND FASCIAS
  7. METAL GUTTERS AND DOWNSPOUTS
  8. METAL HANDRAILS AND GUARDRAILS
  9. STEEL FRAME STAIRS / CONCRETE TREADS



2 STORY ELEVATION 1

1/24/14



2 STORY ELEVATION 2

1/24/14



2 STORY ELEVATION 3

1/24/14



2 STORY ELEVATION 4

1/24/14

SHEET	A2.2		NO. REVISIONS		DATE	DESIGNER: JMW
						DRAWN: LDK
						PROJ. NO: 201214
						CWG: JET
						DATE: SEE INT. STAMP
						SCALE: PER DRAWING
						2 BEDROOM-ELEVATIONS
						DIAMOND SPRINGS VILLAGE APARTMENTS
						ARCHITECTURAL ELEVATIONS

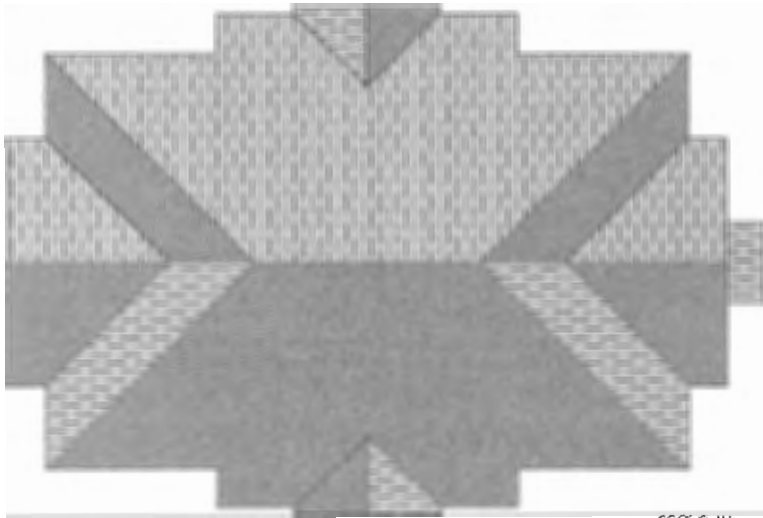

ROOF PLAN  
1/8" = 1'-0"

SQUARE FOOTAGE

1 UNIT - AREA (GROSS) - 1234 SF

RENT/FAMILY - 60 SF

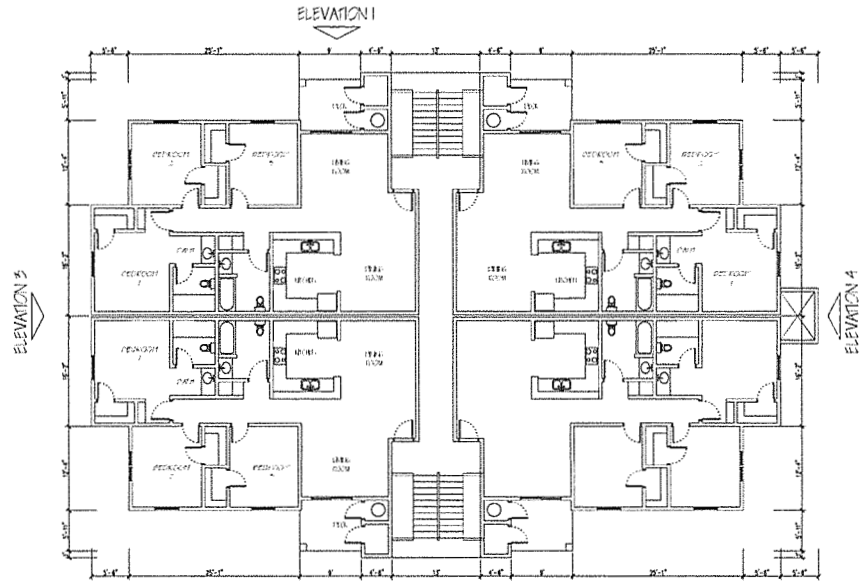

SECOND FLOOR PLAN  
1/8" = 1'-0"

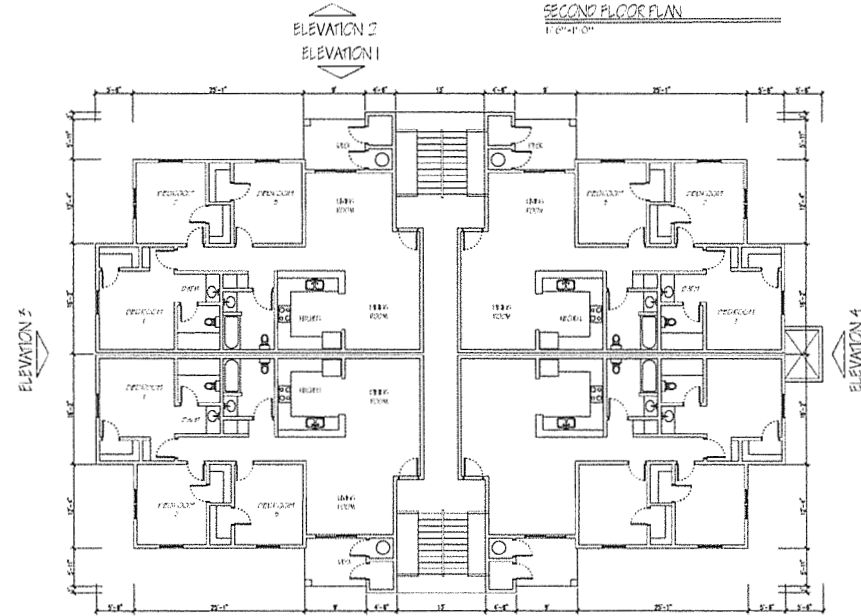

FIRST FLOOR PLAN  
1/8" = 1'-0"

DESIGNED BY FRANKLIN	DATE	NO. REVISIONS	DATE	PROJECT DIAMOND SPRINGS VILLAGE APARTMENTS	CITY CALIFORNIA
PROJECT DIAMOND SPRINGS VILLAGE APARTMENTS					
DIAMOND SPRINGS VILLAGE APARTMENTS FLOOR PLAN/ROOF PLAN			FL DORADO COUNTY 3 BEDROOM		
SHEET A3.7					



- TYPICAL EXTERIOR FINISHES**
1. COMP ROOFING
  2. STUCCO WALL FINISH
  3. STONE VENEER ACCENTS
  4. VINYL FRAME WINDOWS AND SLIDING DOORS
  5. COMPOSITE ENTRY DOORS
  6. FIBER CEMENT TRIMS AND FASCIAS
  7. METAL GUTTERS AND DOWNSPOUTS
  8. METAL HANDRAILS AND GUARDRAILS
  9. STEEL FRAME STAIRS / CONCRETE TREADS

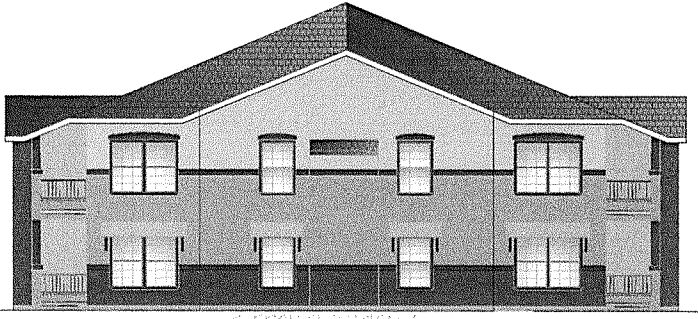

0-2 FRONT ELEVATION 1  
11/1/19



0-2 FRONT ELEVATION 2  
11/1/19



0-2 FRONT ELEVATION 3  
11/1/19



0-2 FRONT ELEVATION 4  
11/1/19

NO.	FIGURE NO.	DATE	REVISION

DESIGNED BY: [blank]  
 DRAWN BY: [blank]  
 PICAL NO: 201914  
 DWG. SEE DWG. STAMP  
 DATE: SEE DWG. STAMP

**DIAMOND SPRINGS VILLAGE APARTMENTS**  
**ARCHITECTURAL ELEVATIONS**  
 3 BEDROOM-ELEVATIONS

SCALE: AS SHOWN  
 CALIFORNIA ARCHITECTS ASSOCIATION  
 REGISTERED ARCHITECT

SHEET  
**A3.2**

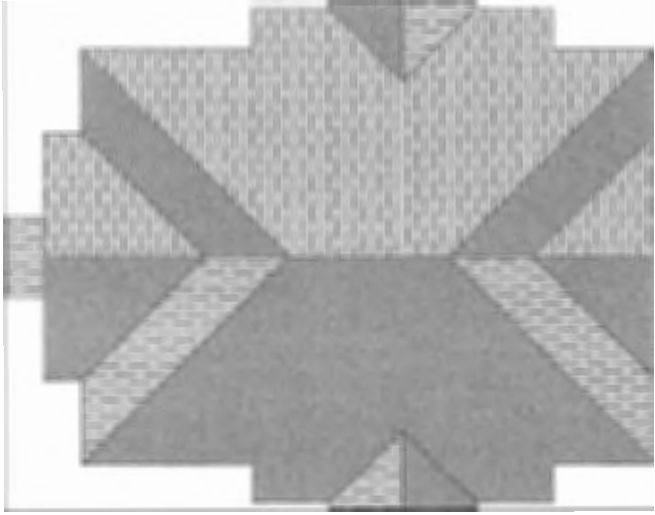

ROOF PLAN  
17'-0" x 47'-0"

SQUARE FOOTAGE

- LIVING AREA (1 BED) - 1274 SF
- LIVING AREA (2 BED) - 1034 SF
- DECK/PATIO (1 BED) - 60 SF
- DECK/PATIO (2 BED) - 60 SF

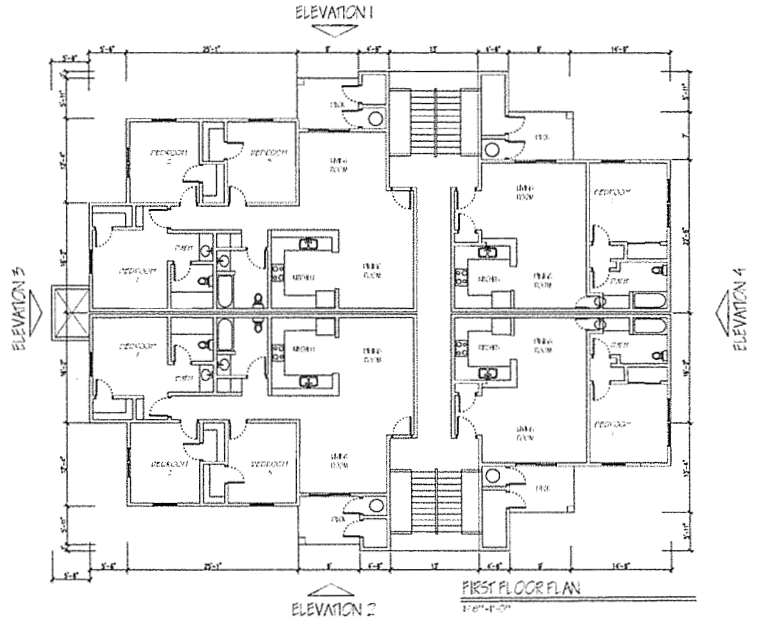
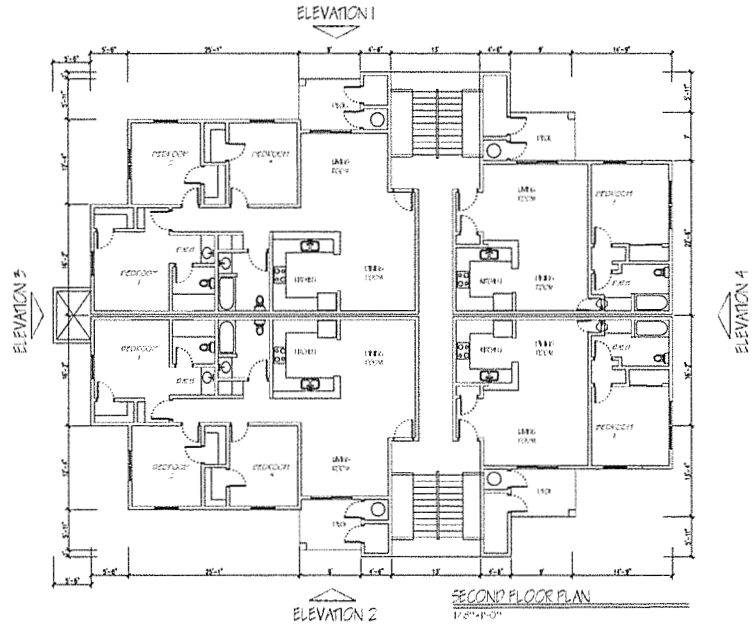

SHEET	DIAMOND SPRINGS VILLAGE APARTMENTS		DESIGNED BY	DATE
	FLOOR PLAN/ROOF PLAN		PREPARED BY	
A4.1	1 BEDROOM/1.5 BEDROOM		PROJ. NO. 221214	
	FL DOMINGO COUNTY, CALIFORNIA		DATE SEE DATE STAMP	
			DATE SEE DATE STAMP	

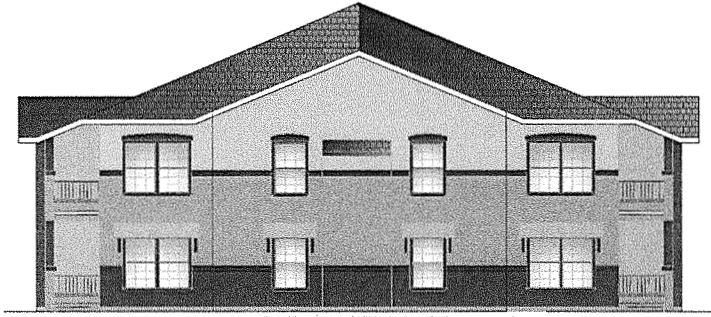

1 BEDROOM/2 BATH ELEVATION 1  
1/27/14



1 BEDROOM/2 BATH ELEVATION 1  
1/27/14



1 BEDROOM/2 BATH ELEVATION 2  
1/27/14



1 BEDROOM/2 BATH ELEVATION 2  
1/27/14

DESIGNED BY DWAYNE MOY	DATE
PROJECT NO. 131114	NO. REVISIONS
DWG. SET DATE 1/27/14	DATE

**DIAMOND SPRINGS VILLAGE APARTMENTS**  
**ARCHITECTURAL ELEVATIONS**  
 1 BEDROOM/2 BATH ELEVATIONS

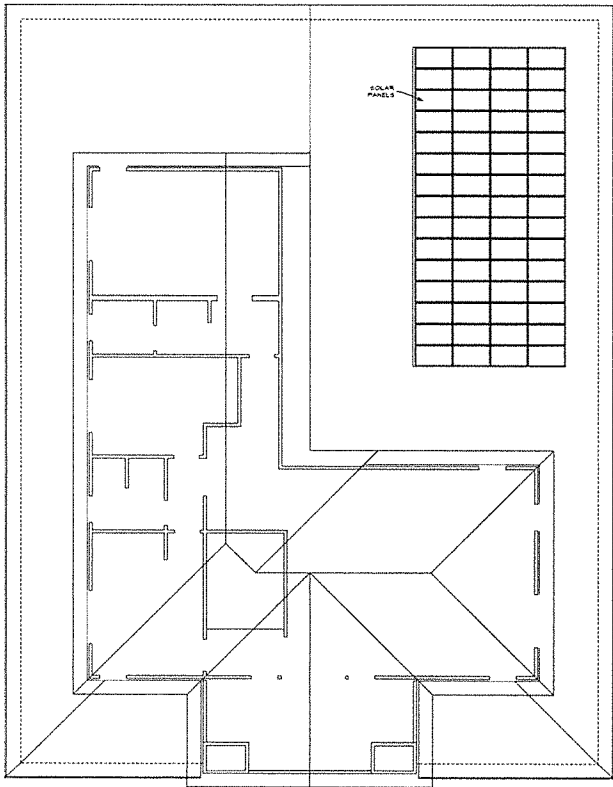

**C** ROOF PLAN  
SCALE: 1/4" = 1'-0"

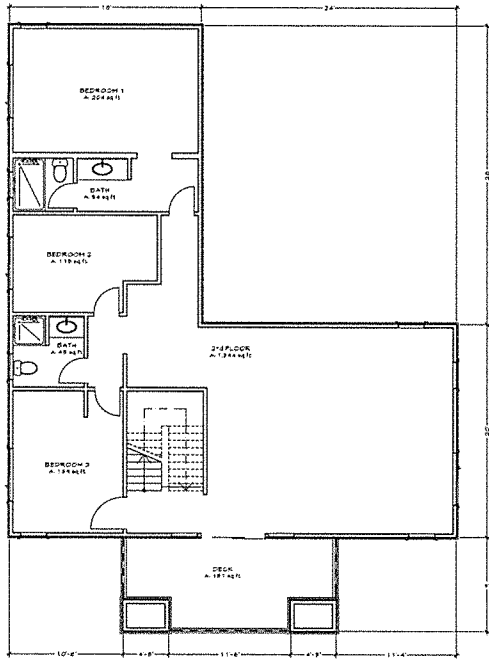

**B** SECOND FLOOR PLAN  
SCALE: 1/8" = 1'-0"

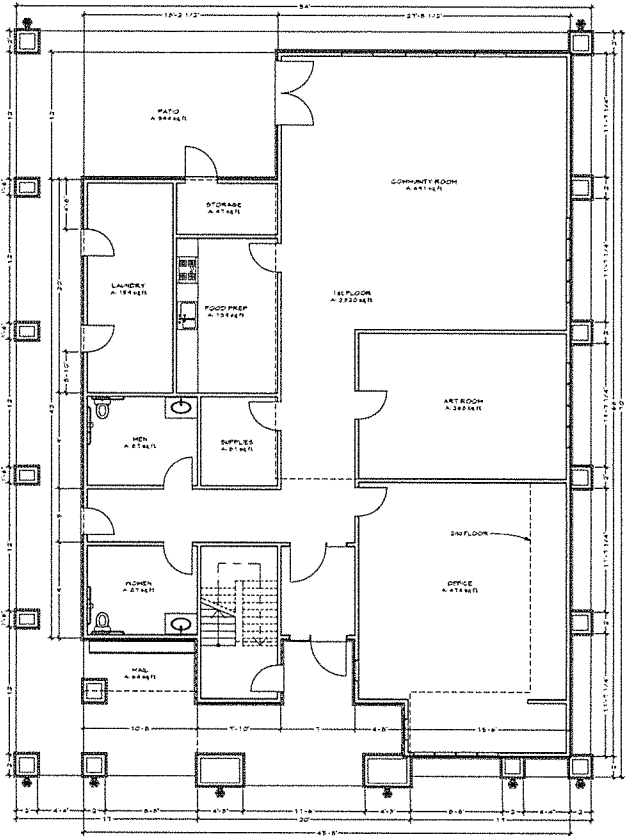

**A** FIRST FLOOR PLAN  
SCALE: 1/8" = 1'-0"

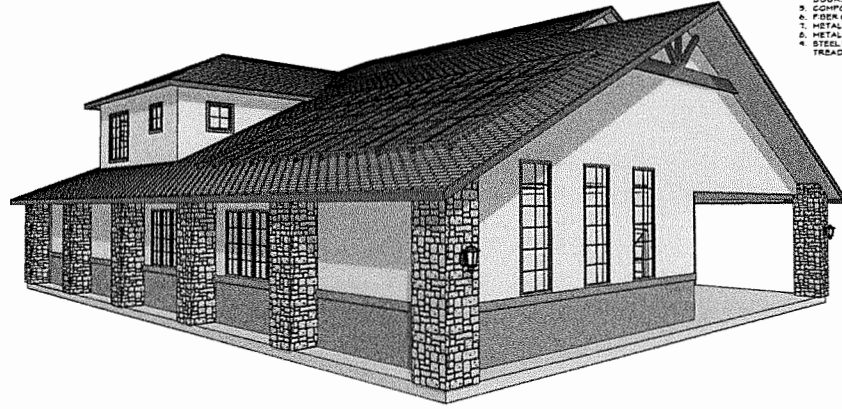
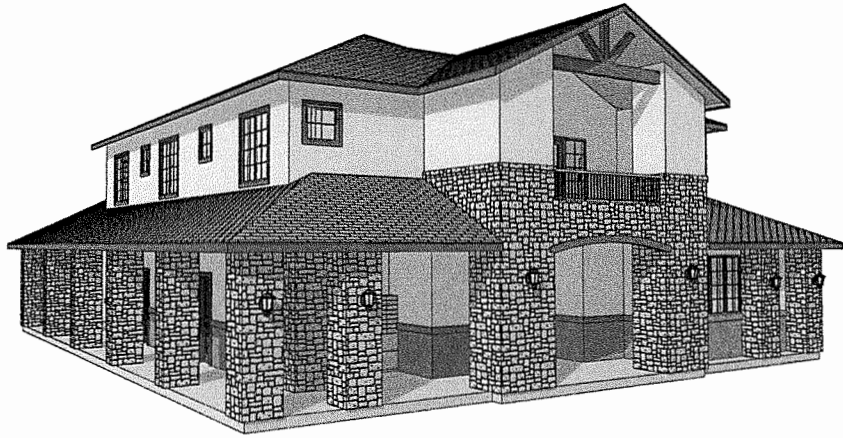

- TYPICAL EXTERIOR FINISHES**
1. GOMF ROOFING
  2. STUCCO WALL FINISH
  3. STONE VENEER ACCENTS
  4. VINYL FRAME WINDOWS AND SLIDING DOORS
  5. COMPOSITE ENTRY DOORS
  6. FIBER CEMENT TRIMS AND FASCIAS
  7. METAL HANDLES AND DOWNSPOUTS
  8. STEEL FRAME STAIRS / CONCRETE TREADS

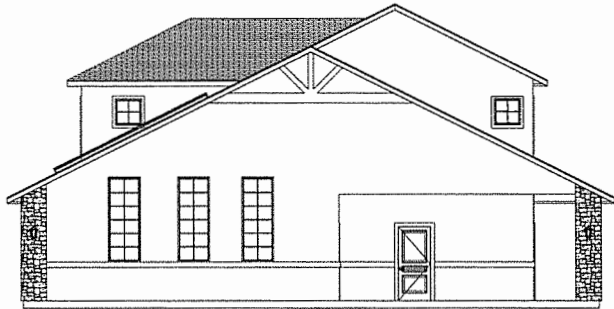

**D REAR ELEVATION**  
SCALE: 1/8" = 1'-0"

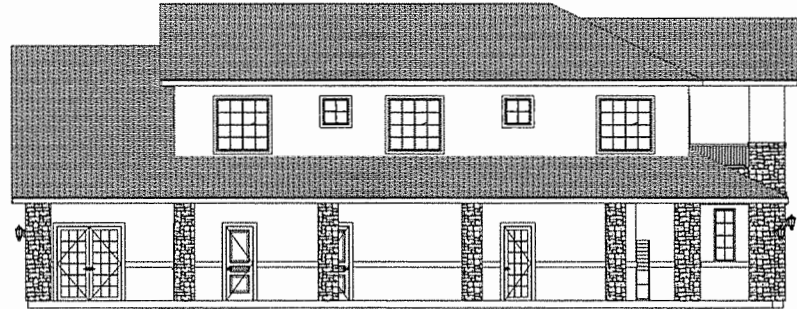

**C LEFT ELEVATION**  
SCALE: 1/8" = 1'-0"



**B FRONT ELEVATION**  
SCALE: 1/8" = 1'-0"



**A RIGHT ELEVATION**  
SCALE: 1/8" = 1'-0"

**DIAMOND SPRINGS VILLAGE APARTMENTS**  
**EXTERIOR ELEVATIONS**

EL DORADO COUNTY

CALIFORNIA

# EL DORADO COUNTY APARTMENTS PRELIMINARY UTILITY PLAN

**LEGEND:**

- PROPOSED FENCE
- - - - - EXISTING FENCE
- - - - - EXISTING FENCE TO REMAIN
- - - - - EXISTING JOINT TRENCH (A)
- - - - - EXISTING WATER
- - - - - EXISTING SEWER
- - - - - EXISTING OVERHEAD WIPES
- - - - - PROPOSED JOINT TRENCH (A)
- - - - - PROPOSED WATER
- - - - - PROPOSED SEWER
- - - - - PROPOSED STORM LINE
- - - - - PROPOSED WATER SERVICE
- - - - - PROPOSED SEWER SERVICE
- - - - - PROPOSED FIRE HYDRANT
- - - - - PROPOSED MANHOLE

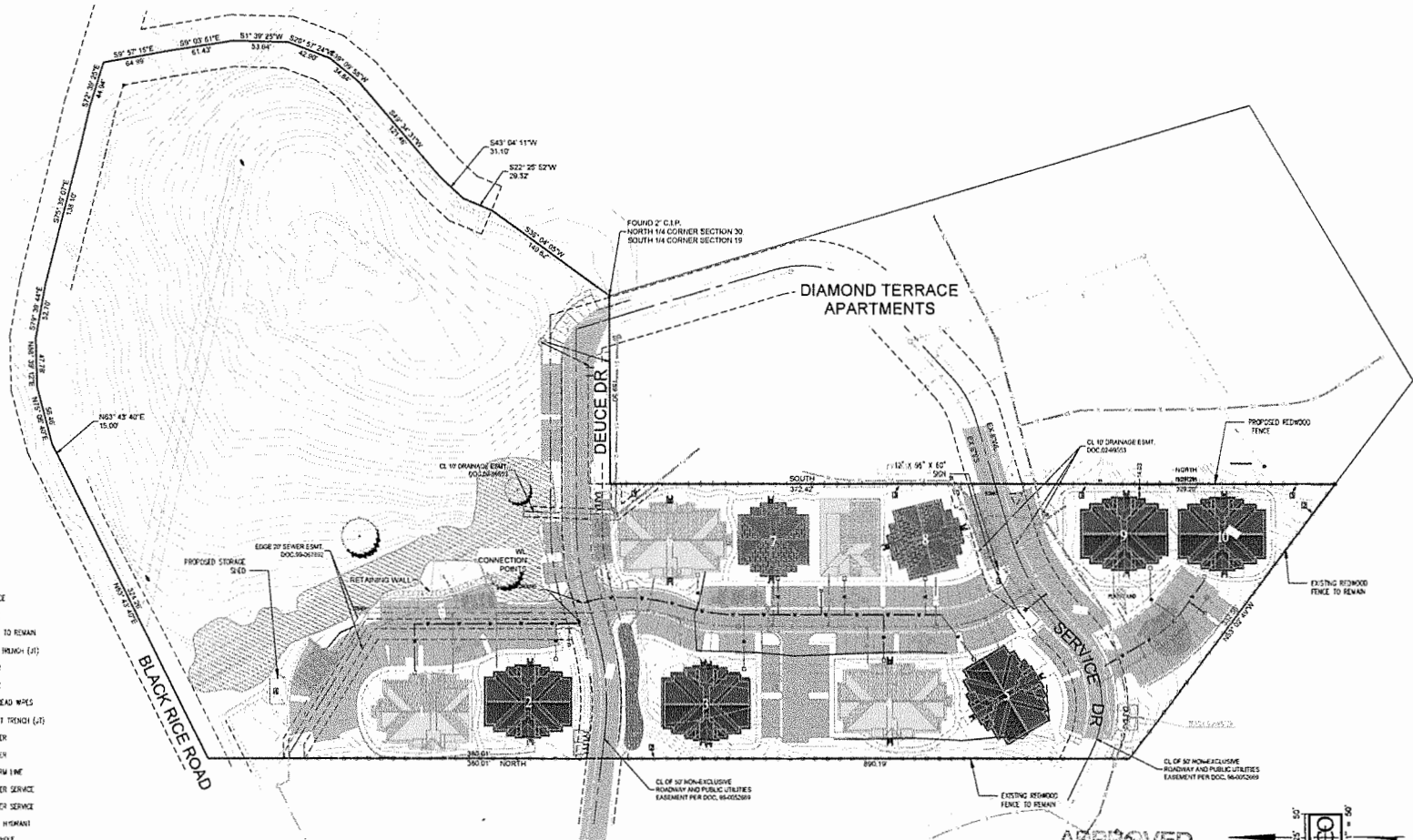

COURTSIDE MANOR  
TOWNHOMES

**Exhibit G**

**APPROVED**  
**EL DORADO COUNTY**  
**PLANNING COMMISSION**  
*Board of Supervisors*

DATE *August 14, 2018*

BY *Roger Trout*  
EXECUTIVE SECRETARY

	DESIGNED: MW	DATE	NO. REVISIONS	CALIFORNIA
	DOWN: JOW			
	PREL. NO. 201214			
	DWG. SEE DAY STAMP			
	DATE: SEE DWG STAMP			

1010 N. GATEWAY  
 SUITE 200  
 EL DORADO, CA 95762  
 TEL: (916) 428-1100  
 FAX: (916) 428-1101  
 WWW.SEO-CA.COM

SEO

CIVIL PLANNING  
 SURVEYING  
 ENGINEERING  
 & SURVEYING

# DIAMOND SPRINGS VILLAGE APARTMENTS

DIAMOND SPRINGS, EL DORADO COUNTY, CALIFORNIA

WATER BUDGET CALCULATIONS	
REFERENCE EVAPOTRANSPIRATION = 47.3 INCHES PER YEAR (CANNING STATION)	
MAWA = $(47.3)(1.02)(1.25) = 60.1$ INCHES PER YEAR	
ETWU = $(60.1)(0.85) = 51.1$ INCHES PER YEAR	
LOW PLANTS = $(51.1)(0.15) = 7.7$ INCHES PER YEAR	
HIGH PLANTS = $(51.1)(0.35) = 17.9$ INCHES PER YEAR	
TOTAL ETWU = $7.7 + 17.9 = 25.6$ INCHES PER YEAR	
ETWU - MAWA = $51.1 - 60.1 = -9.0$ INCHES PER YEAR	

PLANT LEGEND					
SYM	BOTANICAL/COMMON NAME	SIZE	QTY	WATER USE	HT/WD
	TREES CERCIS CANADENSIS 'OAKLEAF' / EASTERN REDBUD FRUIT TREES (APPLE, GRAPEFRUIT, LEMON, ORANGE)	15 GAL	41	LOW	18x18'
	QUERCUS WILZINGERI / INTERIOR LIVE OAK	24" BOX	20	LOW	25x35'
	ACER RUBRUM / RED MAPLE	15 GAL	20	LOW	32x30'
	SHRUBS / GROUND COVER ARCTOSTAPHYLOS 'EMERALD CARPET' / AMANITA OSTIA LADINENSIS / INCHONIA SPOT ROCK ROSE DIETES VEGETA / PORTNIGHT LILY MYRTUS COMMUNIS 'COMPACTA' / COMPACT MYRTLE MULLENBERGIA RHODIOPHYLLA / RED PINE GRASS HARMERIA GULF STREAM COMPACT HEAVENLY BAMBOO ROSMARINUS OFFICINALIS / TUSCAN BLUE ROSEMARY STIPA TERRESTRIS / MEXICAN FEATHER GRASS	5 GAL 5 GAL 1 GAL 5 GAL 5 GAL 1 GAL 1 GAL 1 GAL	- - - - - - - -	LOW LOW LOW LOW LOW LOW LOW LOW	- 4x4' 30x24" 3x3' 4x4' 30x30" 5x7' 30x24"

- ### PLANTING NOTES
- PLANTING SHALL CONFORM TO EL DORADO COUNTY REQUIREMENTS FOR LANDSCAPE SITE DEVELOPMENT.
  - PROVIDE MINIMUM SLOPE OF 1% FOR POSITIVE DRAINAGE AWAY FROM CENTER IN ALL PLANTED AREAS.
  - THE PLANT QUANTITIES SHOWN ON THE DRAWINGS ARE INFORMATIONAL ONLY. THE CONTRACTOR IS RESPONSIBLE FOR FINAL QUANTITIES REQUIRED TO COMPLETE THE WORK. IN CASE OF DISCREPANCY, THE PLAN SHALL GOVERN.
  - ALL TREES SHALL BE PLANTED A MINIMUM OF 5' FROM UNDERGROUND UTILITIES.
  - ALL EXISTING TREES SHALL BE PROTECTED FROM DAMAGE OR INJURY. NO PARKING OR STACKING OF CONSTRUCTION MATERIAL IS ALLOWED WITHIN THE DRIFLINE OF AN EXISTING TREE.
  - IMMEDIATELY AFTER AWARD OF CONTRACT, THE CONTRACTOR SHALL NOTIFY THE LANDSCAPE ARCHITECT IF SPECIFIED PLANT MATERIAL IS AVAILABLE FROM COMMERCIAL NURSERIES. IN THE EVENT THAT A PLANT IS NOT AVAILABLE, THE LANDSCAPE ARCHITECT WILL PROVIDE ALTERNATE PLANT MATERIAL SELECTIONS. SUCH CHANGES WILL NOT ALTER THE CONTRACTOR'S ORIGINAL BID PRICE UNLESS A CREDIT IS DUE TO THE OWNER.
  - THE CONTRACTOR SHALL ENSURE THAT ALL EXCAVATED PLANT PITS HAVE POSITIVE DRAINAGE. PLANT PITS SHALL BE FULLY FILLED WITH WATER AND SHALL DRAIN WITHIN ONE (1) HOUR OF FILLING. THE CONTRACTOR SHALL EXCAVATE THROUGH ANY IMPERVIOUS LAYER IF ENCOUNTERED.
  - ALL PLANT MATERIAL SHALL COMPLY WITH ANSI Z601 STANDARD FOR NURSERY STOCK.
  - ROOT BARRIERS SHALL BE PROVIDED FOR ALL TREES WITHIN ANY PLANTING AREAS THAT ARE LESS THAN 10' WIDE.
  - ALL PLANTER AREAS SHALL RECEIVE A 3" LAYER OF BARK MULCH.
  - THE CONTRACTOR SHALL PROVIDE A SOILS REPORT PREPARED BY A QUALIFIED SOILS SPECIALIST AND SUBMIT TO THE OWNER FOR FINAL APPROVAL. SOILS SAMPLES SHALL BE COLLECTED AFTER POSITIVE GRADING OPERATIONS AND PRIOR TO THE INSTALLATION OF PLANT MATERIAL. SOIL SAMPLES SHALL BE SUFFICIENTLY NUMEROUS TO ACCOUNT FOR ANY SOIL VARIATIONS THAT MAY BE PRESENT ON THE SITE. THE FOLLOWING MINIMUM ITEMS SHALL BE INCLUDED IN THE ANALYSIS:
    - INfiltration RATE.
    - SOIL TEXTURE.
    - CATION EXCHANGE CAPACITY.
    - SOIL FERTILITY INCLUDING TESTS FOR NITROGEN, POTASSIUM, PHOSPHORUS, PH. ORGANIC MATTER AND SPECIFIC CONDUCTANCE (E.C.).
  - PRIOR TO PLANTING, SOIL AMENDMENTS SHALL BE ADDED PER RECOMMENDATIONS OF THE SOILS REPORT. SOIL AMENDMENTS SHOWN ON THE PLANS ARE TO BE USED FOR BIDDING PURPOSES ONLY. THE RESULTS OF THE SOILS TESTS THE CONTRACTOR PERFORMS SHALL DETERMINE ACTUAL AMENDMENTS. FAILURE TO PERFORM SOILS ANALYSIS AND REQUIRE SOILS AMENDMENTS WILL BE AT THE RISK OF THE CONTRACTOR. CONTRACTOR WILL BE REQUIRED TO REMOVE AND REPLACE ANY PLANT MATERIAL, BANK, ETC. INSTALLED PRIOR TO SOIL AMENDMENTS (AT CONTRACTOR'S EXPENSE) TO ALLOW FOR INSTALLATION OF REQUIRED AMENDMENTS.

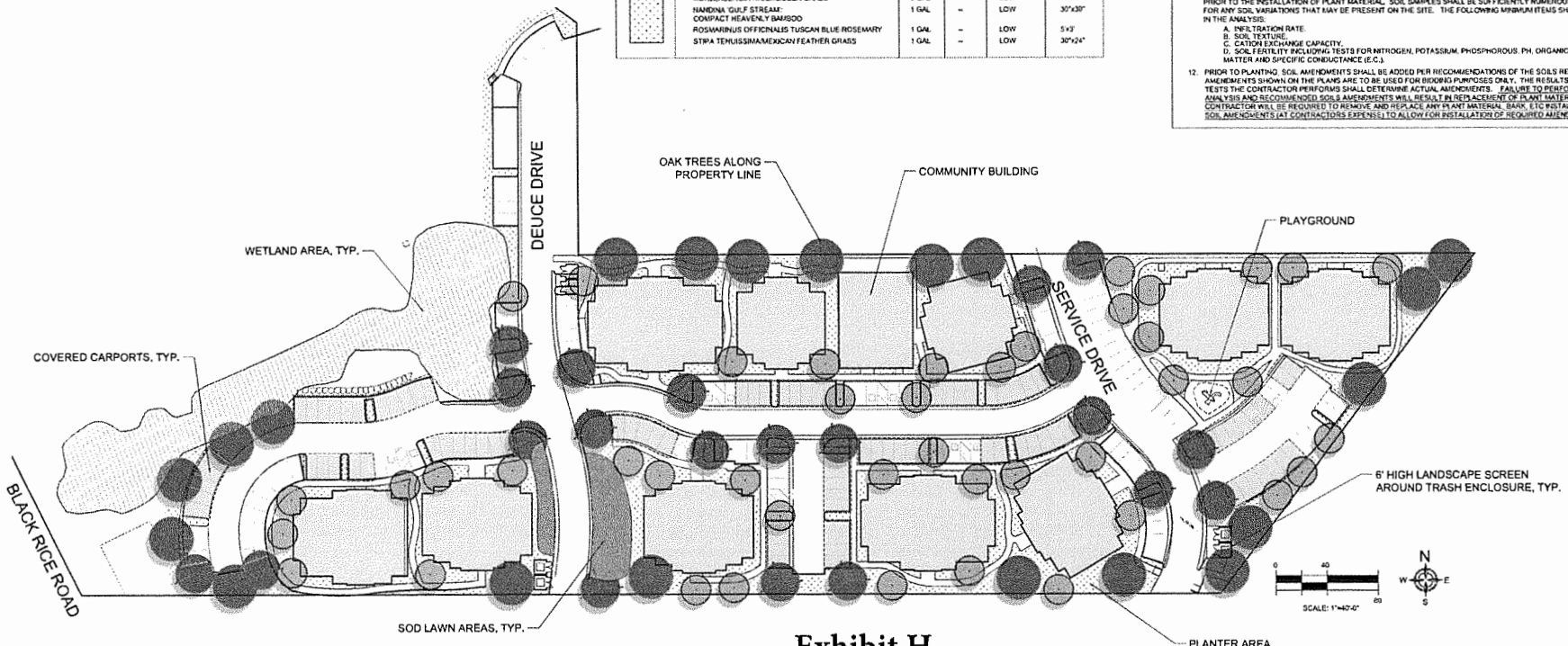

Exhibit H

PRELIMINARY LANDSCAPE PLAN  
MARCH 21, 2017

APPROVED  
EL DORADO COUNTY  
PLANNING COMMISSION  
Board of Supervisors  
DATE August 14, 2018  
BY Roger Vent/Cmt  
EXECUTIVE SECRETARY



SHEET  
L1  
OF  
TOTAL  
1

© MSLA, Project No. 1711817, Diamond Springs, 4411 Lakeview Dr., El Dorado, CA 95623, 2017, 03/21/17

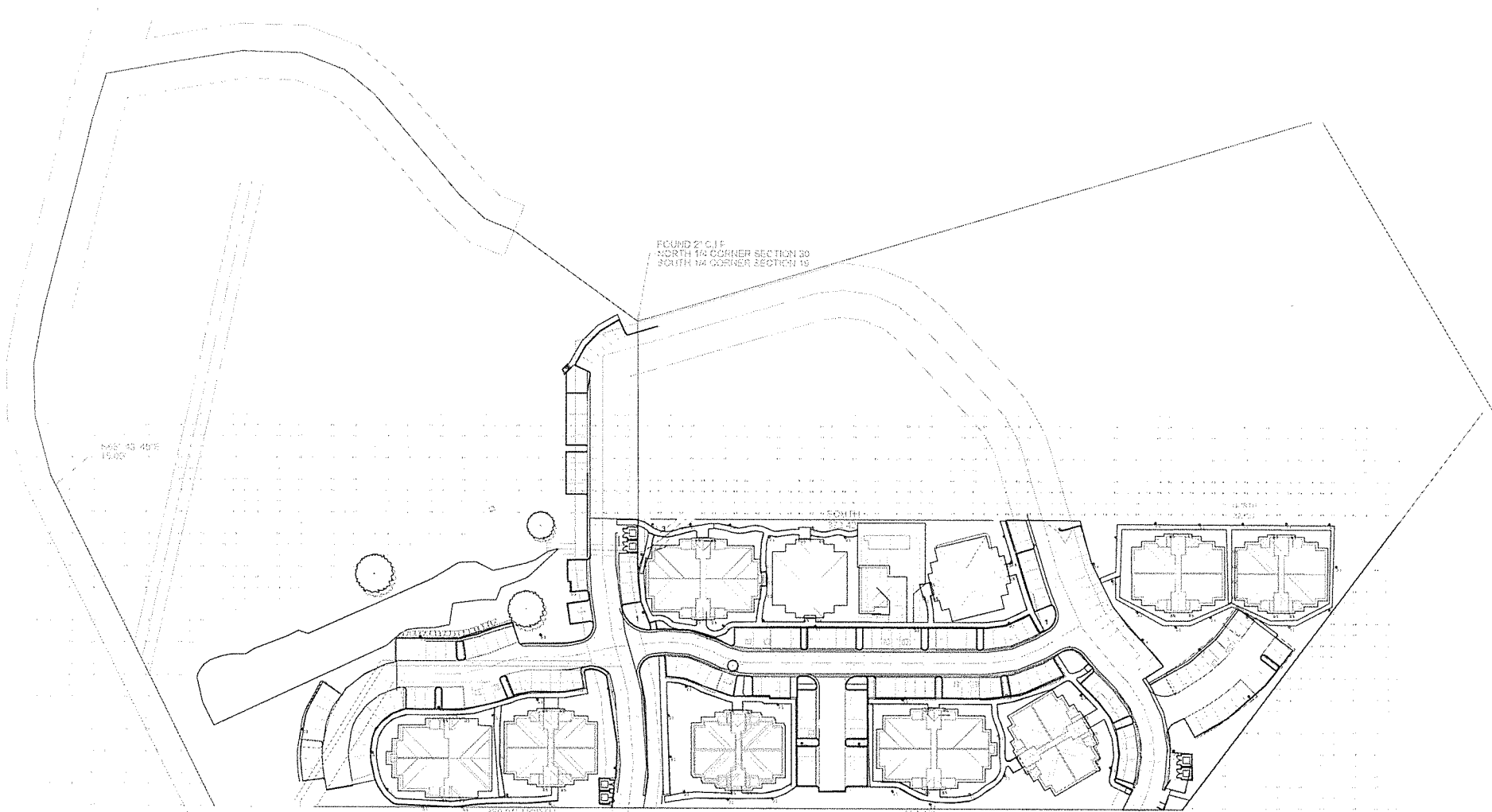

# Exhibit I

APPROVED  
 EL DORADO COUNTY  
~~PLANNING COMMISSION~~  
 Board of Supervisors  
 DATE *August 14, 2018*  
 BY *Roger [Signature]*  
 EXECUTIVE SECRETARY

NO.	DESCRIPTION	DATE	BY
1	PREPARED	8/14/18	[Signature]
2	REVIEWED	8/14/18	[Signature]
3	APPROVED	8/14/18	[Signature]



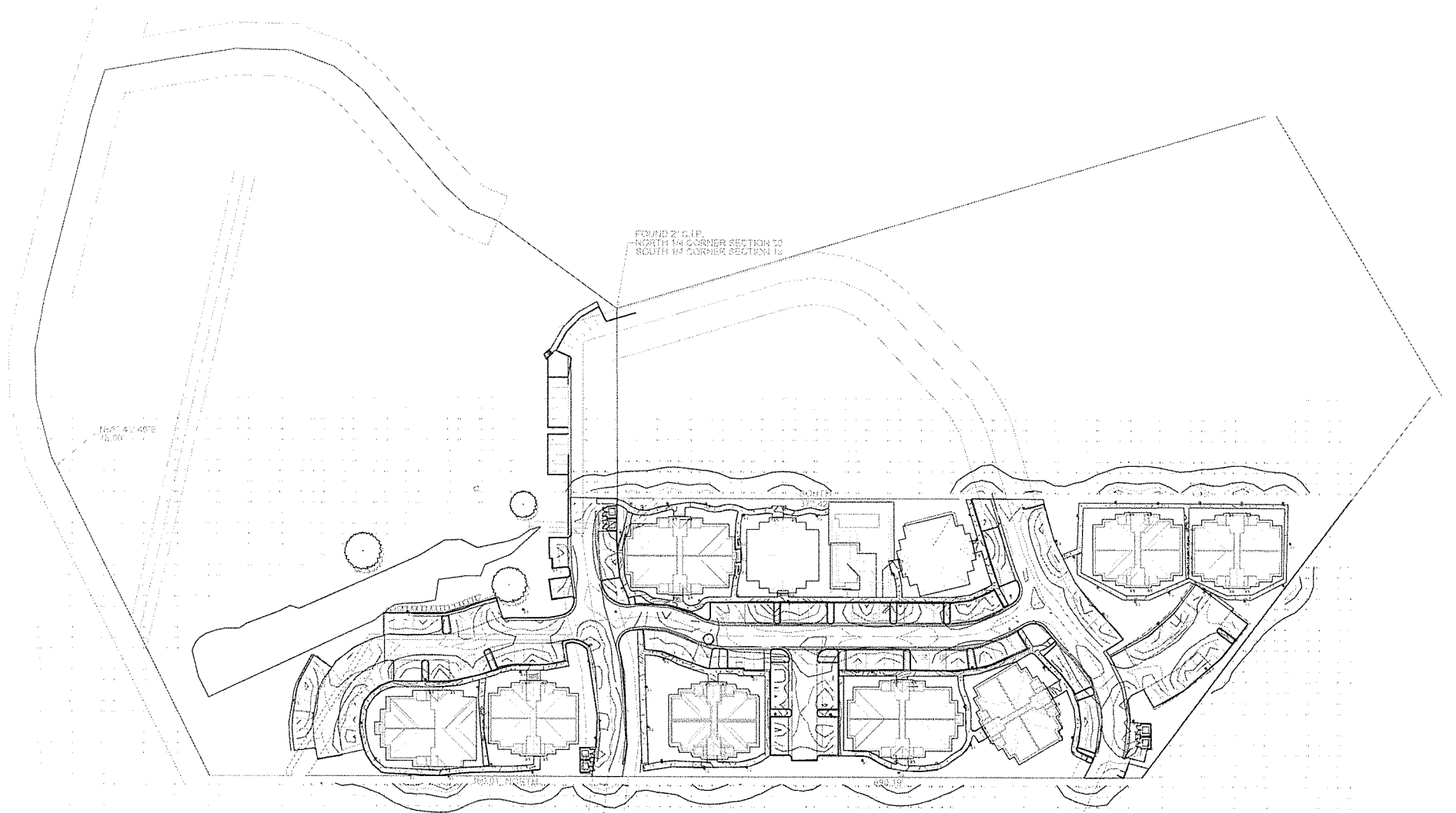

FOUND 21 C.I.P.  
 NORTH 1/4 CORNER SECTION 70  
 SOUTH 1/4 CORNER SECTION 70

145° 41' 40\"/>

PROJECT INFORMATION

PROJECT NO.	DATE	DESCRIPTION

REVISIONS

NO.	DATE	DESCRIPTION

## DESCRIPTION

The Aspen 1900-OA bollard features a sleek, contemporary aesthetic and low glare fixed optics. Lamp source selections include LED, incandescent PAR lamps or low voltage MR16 halogen lamps. Luminaires with a halogen source are available with an integral or remote 12V transformer option. Our patented LumaLevel™ leveling system provides quick installation, easy adjustment, secure mounting and protection from vibration. Aspen bollards are available in two standard heights of 24" [610mm] and 30" [762mm].

Catalog #		Type
Project		
Comments		Date
Prepared by		

## SPECIFICATION FEATURES

### Material

Mounting base and housing are precision-machined from corrosion-resistant 6061-T6 aluminum billet and extrusion.

### Finish

Fixture and mounting base are double protected by a RoHS compliant chemical film undercoating and polyester powdercoat paint finish, surpassing the rigorous demands of the outdoor environment. Fixture housing is available in a variety of standard colors. Mounting base is painted black.

### Lens

Lens is machined from solid U.V. stabilized clear acrylic and is designed to produce maximum

light output with low brightness.

### Adjustable Mounting Base

Machined 6061-T6 aluminum mounting base assembly is equipped with the patented LumaLevel™ leveling system that includes mounting chassis, 70 shore neoprene base pad, stainless steel hardware and 3/4" conduit entry. The LumaLevel™ leveling system provides quick installation, easy adjustment, secure mounting and protection from vibration.

### Anchor Bolts & Template

Three (3) 3/8" x 12" galvanized anchor bolts and a galvanized steel anchor bolt template are standard. Anchor bolts and template are available to ship in advance of fixture for rough-in purposes (specify option -LAB and order anchor bolts/template kit separately).

### Hardware

Stainless steel hardware is standard to provide maximum corrosion-resistance.

### Socket

PAR20: Ceramic socket with 250° C Teflon® coated lead wires and medium base. 50MR16: Ceramic socket with 250° C Teflon® coated lead wires and GU5.3 bi-pin base.

### Electrical

20LED: 120-277VAC, 50/60Hz, rated for -40°C to +40°C [-40°F to 104°F] operation temperature. 50MR16: 12V transformer required (not included). Remote transformer is available from Lumière as an accessory - see the Accessories & Technical Data section of this catalog for details. 50MR16: XXX/12V includes integral electronic transformer - must specify voltage.

### LED

LED light engine with integrated driver. Includes four (4) field-adjustable, pushbutton activated light level selections: 100%, 80%, 55%, or 18%. Available in 2700K, 3000K, 3500K and 4000K color temperatures at 80 CRI. Dimming: 120V Phase dimming at highest (100%) light level. 120-277V universal 0-10V dimming available at 100%, 80% and 55% light levels.

### Lamp

Halogen or Incandescent lamp options available. Lamps not included. Soraa lamp compatible.

### Warranty

Lumière warrants its fixtures against defects in materials & workmanship for three (3) years for halogen and incandescent or five (5) years for LED. Auxiliary equipment such as transformers, ballasts and lamps carry the original manufacturer's warranty.

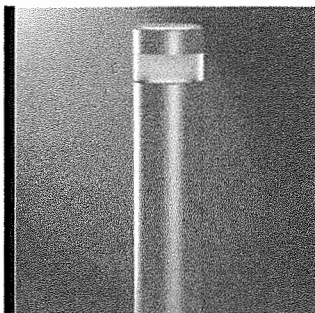

## ASPEN 1900-OA LED Halogen Incandescent

APPLICATIONS:  
OPEN APERTURE BOLLARD  
ACCENT MARKER



### CERTIFICATION DATA

UL and cUL Wet Location Listed  
LM79 / LM80 Compliant  
ROHS Compliant  
IP66 Ingressed Protection Rated

### TECHNICAL DATA

20W LED, L70/60,000 hours  
40°C Maximum Temperature Rating  
50W (max.) MR16  
Halogen | Low Voltage | Line Voltage  
50W (max.) PAR20  
Incandescent | Line Voltage

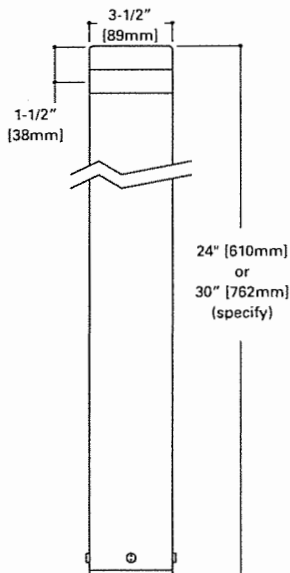

## ORDERING INFORMATION

Sample Number: 1900-OA-24-50MR16-120/12-BZ-LAB

Series	Height	Source	Voltage	Finish	Options
1900-OA=Aspen Bollard Open Aperture	24=24" Nominal Height 30=30" Nominal Height	LED 20LED2715=20W LED, 2700K, 80CRI 20LED3015=20W LED, 3000K, 80CRI 20LED3515=20W LED, 3500K, 80CRI 20LED4015=20W LED, 4000K, 80CRI Halogen 50MR16=50W Max Halogen MR16, GU5.3 Base Incandescent 50PAR20=50W Max Halogen PAR20, Medium Base	LED UNV =120-277V (50-60Hz) Halogen (12V remote transformer) 12=12V Fixture (Remote Transformer Required - Order Separately) Halogen (integral transformer) 120/12=120V to 12V Integral Transformer 277/12=277V to 12V Integral Transformer Incandescent 120=120V	Painted BK=Black BZ=Bronze CS=City Silver VE=Verde WT=White	LAB=Less Anchor Bolts & Template (Requires Anchor Kit Be Ordered Separately)

**ACCESSORIES**

Anchor Bolts & Templates
7048PK= Anchor Bolt/Template Kit for 24" & 30" Aspen Bollards

**PHOTOMETRY**

**LUMENS - CRI/CCT TABLE**

CCT (K) / Color	CRI Minimum [Typical]	Light Level	Nominal Watts @ 120V [277V]	Delivered Lumens	lm/W
4000	80 [83] R9	100%	16.9 [19.6]	237	14.0
		80%	12.8 [14.6]	195	15.5
		55%	8.6 [10.1]	142	16.5
		18%	3.8 [4.4]	57	15.0

All specifications subject to tolerance of +/- 10%

**CCT MULTIPLIER TABLE**

CCT(K) / COLOR	MULTIPLIER
2700K	0.922
3000K	0.953
3500K	0.992
4000K	1.000

Note: Multiplier can be used to calculate Lumens and footcandle (FC) values.

**LUMEN MAINTENANCE**

Ambient Temperature	TM-21 Lumen Maintenance (72,000 Hours)	TM-21 Reported L70(10k) (Hours)
25°C	> 85%	> 60,000
40°C		

**ISO-FOOTCANDLE PLOTS - 24" MOUNTING HEIGHT**

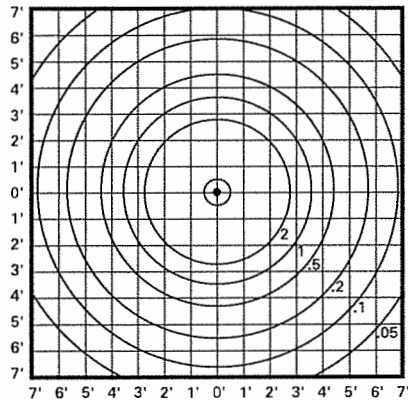

FILE NAME: 1900-OA-24-20LED4015-UNV-BK.ies  
 LAMP: LED MODULE -TLM-R20A-A124015, 4000K  
 LUMENS: 1280 (module lumens)  
 WATTS: 15.7  
 TEST NO: P189461

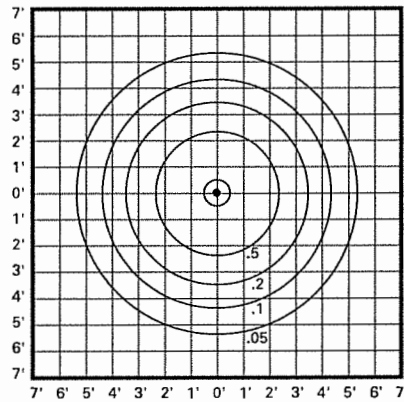

FILE NAME: 1900-OA-24-50PAR20-120-BK.ies  
 LAMP: INCANDESCENT 50W PAR20 - 10°  
 LUMENS: 530  
 WATTS: 50  
 TEST NO: P189462

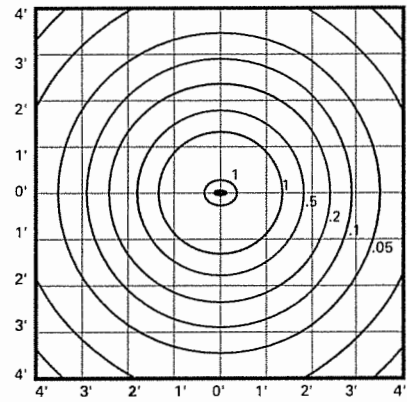

FILE NAME: 1900-OA-24-50MR16.ies  
 LAMP: HALOGEN 50W MR16 - 10°  
 LUMENS: 950  
 WATTS: 50  
 TEST NO: ITL52169

**TECHNICAL NOTES AND FORMULAS**

- Beam diameter is to 50% of maximum footcandles, rounded to the nearest half-foot.
- Footcandle values are initial. Apply appropriate light loss factors where necessary.
- The fixture body must be removed from the base to adjusting light level or relamp. Do not try to remove top cap or optical lens.

## DESCRIPTION

The geometric form of MESA LED luminaire allows it to adapt to either contemporary or traditional architectural settings. Available in single or twin pole mount configurations with optional wall mounting capability, the MESA LED luminaire's mounting options allow for harmonized site design whether at the entryway or in the parking lot. UL/cUL listed for use in wet locations.

Catalog #		Type	
Project		Date	
Comments			
Prepared by			

## SPECIFICATION FEATURES

### Construction

**HOUSING:** Die-cast aluminum main housing and spider mount base maintain a minimum 0.125 wall thickness. Integral aluminum heat sink provides superior thermal heat transfer in +40°C ambient environments. **DOOR ASSEMBLY:** Top mounted, heavy wall, die-cast aluminum door maintains a nominal 0.125 thickness. Door includes a self-retaining interior hinge. **GASKET:** Continuous silicone gasket provided to seal housing door assembly and optic tray. **LENS:** Downlight lens is LED board integrated acrylic over-optics, each individually sealed for IP66 rating. **HARDWARE:** Four inset fasteners on underside of housing provide access to luminaire interior. Concealed, stainless steel four bar hinge lock allows door to lock in the open position.

### Optics

Choice of twelve patented, high-efficiency AccuLED Optic™ technology manufactured from injection-molded acrylic. Optics are precisely designed to shape the light output, maximizing efficiency and application spacing. AccuLED Optic technology, creates consistent distributions with the

scalability to meet customized application requirements. Offered Standard in 4000K (+/- 275K) CCT and minimum 70 CRI. Optional 3000K CCT, 5000K CCT and 5700K CCT. For the ultimate level of spill light control, an optional house-side shield accessory can be field or factory installed. The house-side shield is designed to seamlessly integrate with the SL2, SL3 or SL4 optics. LightBAR optic tray is removable and able to rotate 360° in 90° increments for specific placement of the distribution relative to fixture.

### Electrical

LED drivers mount to die-cast aluminum back housing for optimal heat sinking, operation efficacy, and prolonged life. Standard drivers feature electronic universal voltage (120-277V 50/60Hz), 347V 60Hz or 480V 60Hz operation, greater than 0.9 power factor, less than 20% harmonic distortion, and is suitable for operation in -40°C to 40°C ambient environments. All fixtures are shipped standard with 10kV/10kA common – and differential – mode surge protection. LightBARs feature and IP66 enclosure rating and maintain greater than 95% lumen maintenance at 60,000 hours per

IESNA TM-21. Occupancy sensor and dimming options available.

### Mounting

Fitter assembly mounts over 3" O.D. tenon and is secured via three concealed stainless steel set screws. Design of fitter provides seamless transition to 4" round poles. Additional mounting accessories include a dual fixture post mounting arm and wall mount arm.

### Finish

Housing is finished in five-stage super TGIC polyester powder coat paint, 2.5 mil nominal thickness for superior protection against fade and wear. LightBAR™ cover plates are standard white and may be specified to match finish of luminaire housing. Standard colors include black, bronze, grey, white, dark platinum and graphite metallic. RAL and custom color matches available. Consult Outdoor Architectural Colors brochure for a complete selection.

### Warranty

Five-year warranty.

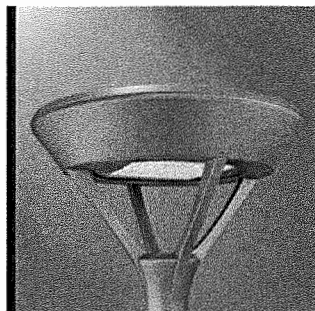

## MSA MESA LED

1-6 LightBARs  
Solid State LED

DECORATIVE LUMINAIRE

## DIMENSIONS

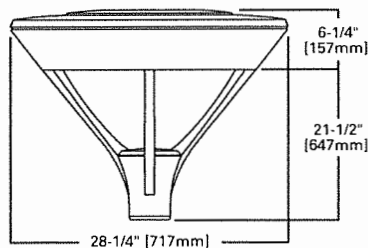

## MOUNTING ACCESSORIES

### WALL MOUNT ARM

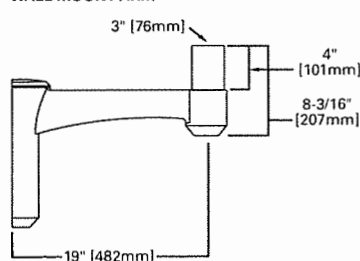

### DUAL MOUNT ARM (EPA 1.36)

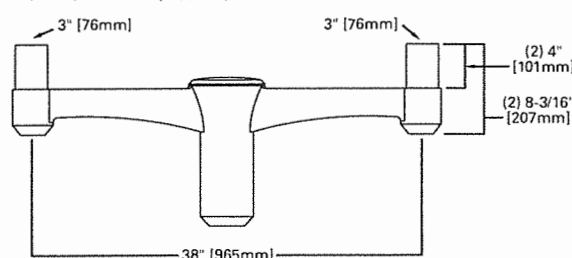

## CERTIFICATION DATA

UL/cUL Listed  
ISO 9001  
IP66 LightBARs  
LM79 / LM80 Compliant  
2G Vibration Tested

## ENERGY DATA

Electronic LED Driver  
>0.9 Power Factor  
<20% Total Harmonic Distortion  
120-277V/50 & 60Hz, 347V/60Hz,  
480V/60Hz  
-40°C Minimum Temperature  
40°C Ambient Temperature Rating

## EPA

Effective Projected Area: (Sq. Ft.)  
Single Mount 1.1

## SHIPPING DATA

Approximate Net Weight:  
50 lbs. (22.7 kgs.)

POWER AND LUMENS BY BAR COUNT (21 LED LIGHTBARS)

Number of LightBARs	E01	E02	E03	E04	E05	E06	
Drive Current	350mA Drive Current						
Power (Watts)	25W	52W	75W	97W	127W	150W	
Current @ 120V (A)	0.22	0.44	0.63	0.82	1.07	1.26	
Current @ 277V (A)	0.10	0.20	0.28	0.36	0.48	0.56	
Power (Watts)	31W	58W	82W	99W	132W	159W	
Current @ 347V (A)	0.11	0.19	0.28	0.29	0.39	0.48	
Current @ 480V (A)	0.09	0.15	0.20	0.21	0.30	0.36	
T2	Lumens	2,460	4,920	7,379	9,839	12,299	14,759
	BUG Rating	B1-U0-G1	B2-U0-G2	B2-U0-G2	B3-U0-G3	B3-U0-G3	B3-U0-G3
T3	Lumens	2,485	4,970	7,456	9,941	12,426	14,911
	BUG Rating	B1-U0-G1	B2-U0-G2	B2-U0-G2	B3-U0-G3	B3-U0-G3	B3-U0-G3
T4	Lumens	2,423	4,845	7,268	9,690	12,113	14,535
	BUG Rating	B1-U0-G1	B1-U0-G2	B1-U0-G2	B2-U0-G2	B2-U0-G3	B2-U0-G3
5MQ	Lumens	2,615	5,230	7,844	10,459	13,074	15,689
	BUG Rating	B2-U0-G1	B3-U0-G1	B3-U0-G1	B3-U0-G2	B4-U0-G2	B4-U0-G2
5WQ	Lumens	2,604	5,207	7,811	10,415	13,018	15,622
	BUG Rating	B2-U0-G1	B3-U0-G1	B3-U0-G2	B4-U0-G2	B4-U0-G2	B4-U0-G2
5XQ	Lumens	2,603	5,206	7,809	10,412	13,015	15,618
	BUG Rating	B2-U0-G1	B3-U0-G2	B3-U0-G2	B4-U0-G3	B4-U0-G3	B4-U0-G3
SL2	Lumens	2,445	4,891	7,336	9,781	12,226	14,672
	BUG Rating	B1-U0-G1	B1-U0-G1	B2-U0-G2	B2-U0-G2	B2-U0-G2	B3-U0-G3
SL3	Lumens	2,461	4,921	7,382	9,842	12,303	14,763
	BUG Rating	B1-U0-G1	B1-U0-G2	B2-U0-G2	B2-U0-G2	B2-U0-G2	B3-U0-G3
SL4	Lumens	2,376	4,752	7,128	9,504	11,880	14,256
	BUG Rating	B1-U0-G1	B1-U0-G2	B1-U0-G2	B2-U0-G2	B2-U0-G3	B2-U0-G3
RW	Lumens	2,398	4,796	7,194	9,591	11,989	14,387
	BUG Rating	B1-U0-G1	B2-U0-G2	B3-U0-G3	B3-U0-G3	B3-U0-G3	B4-U0-G4
SLL/SLR	Lumens	2,227	4,453	6,680	8,906	11,133	13,360
	BUG Rating	B1-U1-G1	B1-U1-G2	B1-U1-G3	B1-U1-G3	B2-U2-G3	B2-U2-G4

LUMEN MAINTENANCE

Ambient Temperature	25,000 Hours*	50,000 Hours*	60,000 Hours*	100,000 Hours	Theoretical L70 (Hours)
25°C	> 99%	> 97%	> 96%	> 93%	> 450,000
40°C	> 98%	> 97%	> 96%	> 92%	> 425,000
50°C	> 97%	> 96%	> 95%	> 91%	> 400,000

\* Per IESNA TM-21 data.

LUMEN MULTIPLIER

Ambient Temperature	Lumen Multiplier
10°C	1.02
15°C	1.01
25°C	1.00
40°C	0.99
50°C	0.96

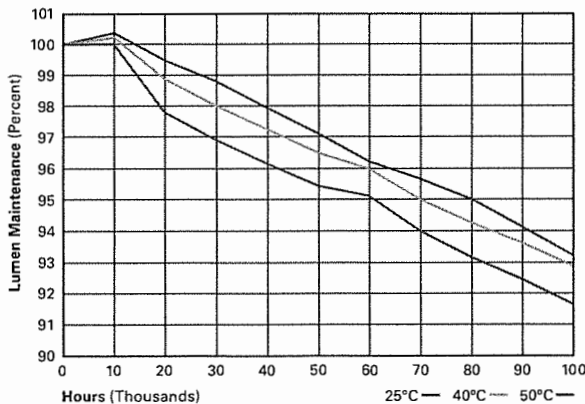

POWER AND LUMENS BY BAR COUNT (7 LED LIGHTBARS)

Number of LightBARS		F01	F02	F03	F04	F05	F06
Drive Current		1A Drive Current					
Power (Watts)		26W	55W	78W	102W	133W	157W
Current @ 120V (A)		0.22	0.46	0.66	0.86	1.12	1.31
Current @ 277V (A)		0.10	0.21	0.29	0.37	0.50	0.58
Power (Watts)		32W	60W	85W	105W	137W	164W
Current @ 347V (A)		0.11	0.19	0.28	0.30	0.41	0.49
Current @ 480V (A)		0.09	0.15	0.21	0.22	0.31	0.37
T2	Lumens	2,031	4,061	6,092	8,122	10,153	12,184
	BUG Rating	B1-U0-G1	B1-U0-G1	B2-U0-G2	B2-U0-G2	B3-U0-G3	B3-U0-G3
T3	Lumens	2,052	4,103	6,155	8,206	10,258	12,310
	BUG Rating	B1-U0-G1	B2-U0-G2	B2-U0-G2	B3-U0-G3	B3-U0-G3	B3-U0-G3
T4	Lumens	2,000	4,000	6,000	7,999	9,999	11,999
	BUG Rating	B1-U0-G1	B1-U0-G1	B1-U0-G2	B1-U0-G2	B2-U0-G2	B2-U0-G3
5MQ	Lumens	2,159	4,317	6,476	8,634	10,793	12,951
	BUG Rating	B1-U0-G1	B2-U0-G1	B3-U0-G1	B3-U0-G2	B3-U0-G2	B4-U0-G2
5WQ	Lumens	2,149	4,299	6,448	8,597	10,747	12,896
	BUG Rating	B2-U0-G1	B3-U0-G1	B3-U0-G2	B3-U0-G2	B4-U0-G2	B4-U0-G2
5XQ	Lumens	2,149	4,298	6,446	8,595	10,744	12,893
	BUG Rating	B2-U0-G1	B3-U0-G2	B3-U0-G2	B3-U0-G3	B4-U0-G3	B4-U0-G3
SL2	Lumens	2,019	4,037	6,056	8,075	10,093	12,112
	BUG Rating	B1-U0-G1	B1-U0-G1	B1-U0-G2	B2-U0-G2	B2-U0-G2	B2-U0-G2
SL3	Lumens	2,031	4,062	6,094	8,125	10,156	12,187
	BUG Rating	B1-U0-G1	B1-U0-G1	B1-U0-G2	B2-U0-G2	B2-U0-G2	B2-U0-G2
SL4	Lumens	1,961	3,923	5,884	7,846	9,807	11,769
	BUG Rating	B1-U0-G1	B1-U0-G1	B1-U0-G2	B1-U0-G2	B2-U0-G2	B2-U0-G3
RW	Lumens	1,980	3,959	5,939	7,918	9,898	11,877
	BUG Rating	B1-U0-G1	B2-U0-G2	B3-U0-G3	B3-U0-G3	B3-U0-G3	B3-U0-G3
SLL/SLR	Lumens	1,838	3,676	5,514	7,352	9,191	11,029
	BUG Rating	B0-U1-G1	B1-U1-G2	B1-U1-G2	B1-U1-G3	B1-U1-G3	B2-U2-G3

LUMEN MAINTENANCE

Ambient Temperature	25,000 Hours*	50,000 Hours*	60,000 Hours*	100,000 Hours	Theoretical L70 (Hours)
25°C	> 99%	> 97%	> 96%	> 93%	> 450,000
40°C	> 98%	> 97%	> 96%	> 92%	> 425,000
50°C	> 97%	> 96%	> 95%	> 91%	> 400,000

\* Per IESNA TM-21 data.

LUMEN MULTIPLIER

Ambient Temperature	Lumen Multiplier
10°C	1.02
15°C	1.01
25°C	1.00
40°C	0.99
50°C	0.96

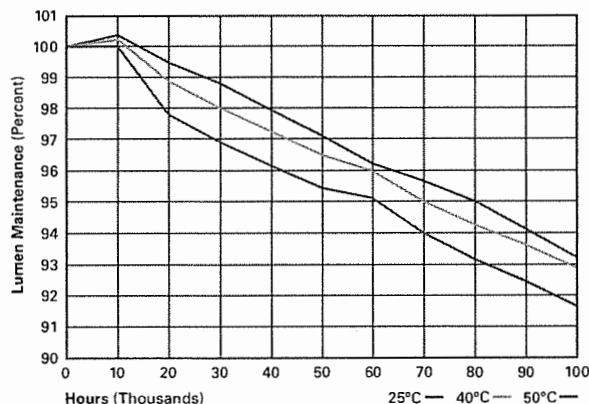

## ORDERING INFORMATION

Sample Number: MSA-E06-LED-E1-T3-GM

Product Family	Number of LightBARs <sup>1,2</sup>	Lamp Type	Voltage	Distribution	Color <sup>5</sup>
MSA=Mesa	E01=(1) 21 LED LightBAR <sup>3</sup> E02=(2) 21 LED LightBARs E03=(3) 21 LED LightBARs E04=(4) 21 LED LightBARs E05=(5) 21 LED LightBARs E06=(6) 21 LED LightBARs F01=(1) 7 LED LightBAR <sup>3</sup> F02=(2) 7 LED LightBARs F03=(3) 7 LED LightBARs F04=(4) 7 LED LightBARs F05=(5) 7 LED LightBARs F06=(6) 7 LED LightBARs	LED=Solid State Light Emitting Diodes	E1=Electronic (120-277V) 347=347V 480=480V <sup>4</sup>	T2=Type II T3=Type III T4=Type IV SL2=Type II w/Spill Control SL3=Type III w/Spill Control SL4=Type IV w/Spill Control RW=Rectangular Wide SMQ=Type V Square Medium 5WQ=Type V Square Wide 5XQ=Type V Square Extra Wide SLL=90° Spill Light Eliminator Left SLR=90° Spill Light Eliminator Right	AP=Grey BZ=Bronze BK=Black DP=Dark Platinum GM=Graphite Metallic WH=White
Options (Add as Suffix)				Accessories (Order Separately) <sup>11</sup>	
PC=Button Type Photocontrol (Specify Voltage) R=NEMA Twistlock Photocontrol Receptacle 2L=Two Circuits <sup>5</sup> LCF=LightBAR Cover Plate Matches Housing Finish 7030=70 CRI / 3000K CCT <sup>7</sup> 7050=70 CRI / 5000K CCT <sup>7</sup> 7060=70 CRI / 5700K CCT <sup>7</sup> 8030=80 CRI / 3000K CCT <sup>7</sup> ICB=Integral Cold Weather Battery Pack (Specify 120 or 277V) <sup>8</sup> DIMRF-LW=LumaWatt Wireless Sensor, Wide Lens for 8' - 16' Mounting Height <sup>9</sup> DIMRF-LN=LumaWatt Wireless Sensor, Narrow Lens for 16' - 40' Mounting Height <sup>9</sup> HSS=Factory Installed House Side Shield <sup>10</sup>				VA6028-XX=Dual Mount Arm (EPA 1.38) VA6029-XX=Wall Mount Arm OA/RA1016=NEMA Photocontrol - Multi-Tap OA/RA1027=NEMA Photocontrol - 480V OA/RA1201=NEMA Photocontrol - 347V MA1253=10kV Circuit Module Replacement LB/HSS-21=Field Installed House Side Shield for "E" LightBARs <sup>10,12</sup> LB/HSS-07=Field Installed House Side Shield for "F" LightBARs <sup>10,12</sup>	

## NOTES:

- Standard 4000K CCT and nominal 70 CRI.
- 21 LED LightBAR powered at 350mA, 7 LED LightBAR powered at 1A.
- Streetside orientation 90° to LightBAR.
- Only for use with 480V Wye systems. Per NEC, not for use with ungrounded systems, impedance grounded systems or corner grounded systems (commonly known as Three Phase Three Wire Delta, Three Phase High Leg Delta and Three Phase Corner Grounded Delta systems).
- Cutsum and RAL color matching available upon request. Consult your lighting representative at Eaton for more information.
- Low-level output varies by bar count. Consult factory. Not available with 347V or 480V. Requires quantity two or more LightBARs.
- Consult factory for lead times and lumen multiplier.
- Available with E01-E04 or F01-F04 configurations only. Specify 120V or 277V. LED cold weather integral battery pack is rated for minimum operating temperature -40°F (-20°C). Operates one LightBAR for 90-minutes. Not available in all configuration, consult factory. Rated for use in 25°C ambient.
- LumaWatt wireless sensors are factory installed and require network components RF-EM-1, RF-GW-1 and RF-ROUT-1 in appropriate quantities. See [www.eaton.com/lighting](http://www.eaton.com/lighting) for LumaWatt application information.
- Only for use with SL2, SL3 and SL4 distributions.
- Replace XX with color designation.
- One required for each LightBAR.

Type S5

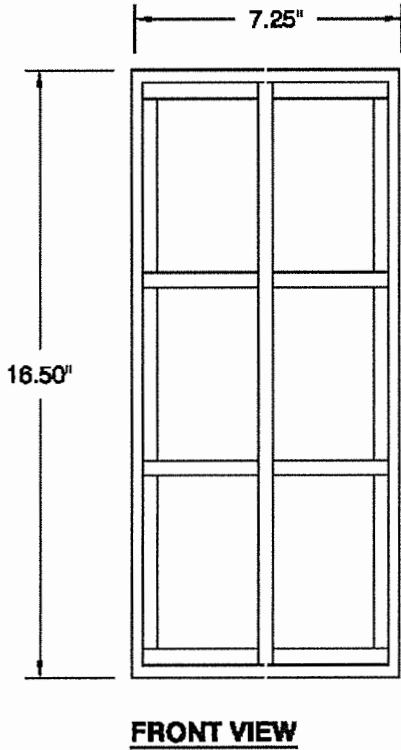
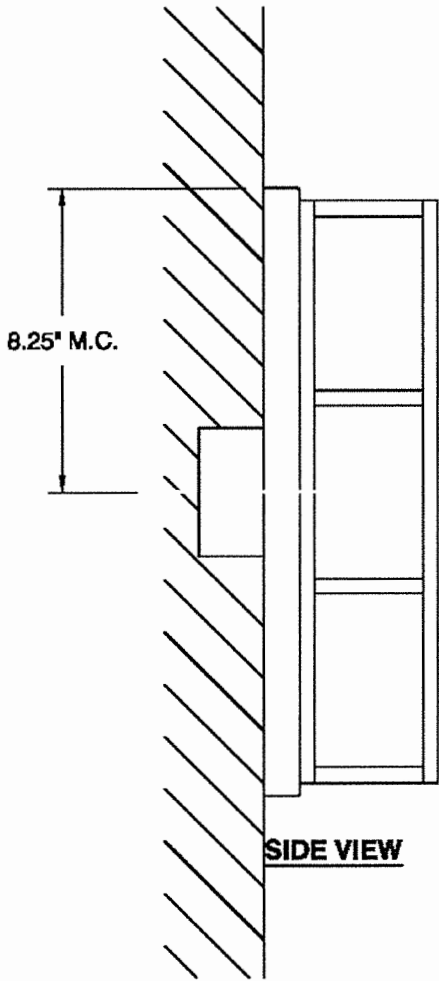
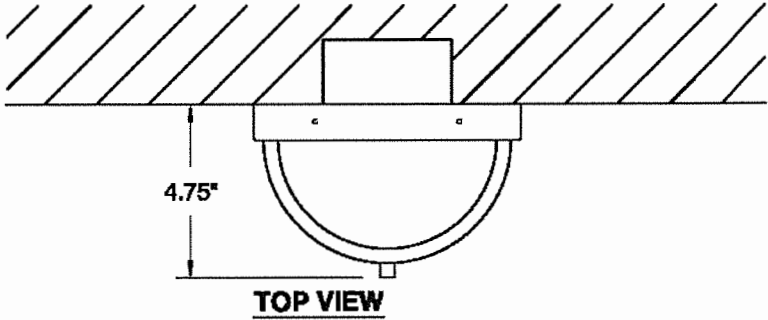

**LEDA outdoor**  
 120v **3-712-224**  
 277v **37-712-224**

OXYGEN LIGHTING ©

**LAMPING**

- o (1x) 10.1w LED Array
- o 3000k, 350mA
- o Initial Lumens: 1460 lm
- o Delivered Lumens: 684 lm
- o CRI >80
- o Color Consistency: 3 Step MacAdams Ellipse

**METAL FINISHES**

- (All finishes polyester powdercoat)
- o **22** - Oiled Bronze
  - o **24** - Satin Nickel

**DIMENSIONS**

- o 7.25" (w) x 16.50" (h)
- o 4.75" (ext.)

**INSTALLATION**

- o 4" Octagonal J-Box
- o ETL WET Listed (Installer must provide a bead of caulk between fixture housing and mounting surface)
- o Wall mount
- o Conforms to UL STD 1598
- o Certified CAN/CSA STD C22.2 No. 250.0

**SPECIAL NOTE**

- o Add caulking around fixture base at the wall to prevent water from entering fixture.

**DIFFUSER**

- o 2 - Matte White Acrylic

**INPUT VOLTAGE**

- o 120v OR 277v 50/60Hz

**DRIVER (Dimmable)**

- o (1x) 0-10v & Reverse Phase Dimming Constant Current, 12w, 350mA

Sample Catalog Number



Series #	Diffuser	Finish	Catalog Number
3-712	- 2	24	= 3-712-224

**oxygen**

**OXYGEN LIGHTING**  
 201 RAILHEAD RD, FORT WORTH, TX 76106  
 TEL. (877) 607-0202 FAX (877) 607-0203  
 WWW.OXYGENLIGHTING.COM

PROJECT: \_\_\_\_\_  
 DATE: \_\_\_\_\_



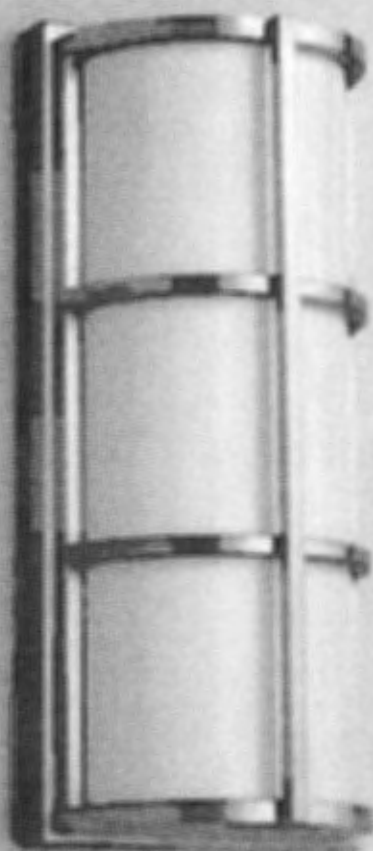

**KHA SLIM 8'2"**

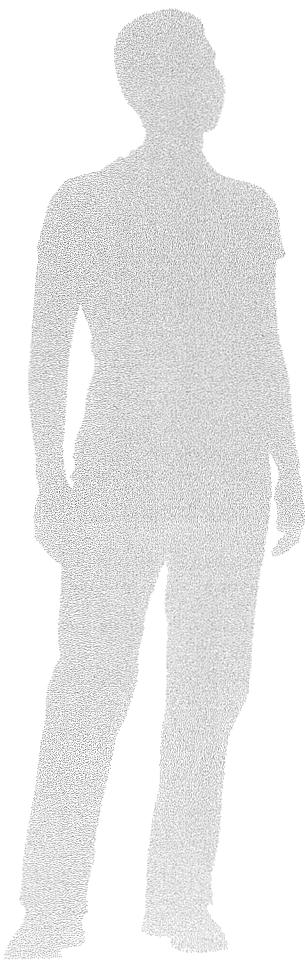

KHA SLIM 8'2"



# KHA SLIM 8' 2"



## KHA SLIM 8'2" CFL

TEXTURED BLACK

STAINLESS STEEL

IRON GRAY

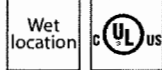

Double reflector optical system for downward light distribution below horizontal and zero upward light pollution. High efficiency comfortable glare free light is provided through indirect light distribution and the upper faceted reflector. The high performance reflector system is designed to provide an efficient light distribution based on height and area to be illuminated.

-Imax 2 x 80°.

-"Body and top manufactured in AISI 316 stainless steel for marine applications, or extruded

-aluminium finished polyester painted Iron grey or Textured black.

-UV stabilised high-tech technopolymer impact resistant lamp cover (PC-HT).

-Reflector in high purity aluminium provides comfortable low glare light control and avoids back reflection onto lamp for improved longevity.

-Technopolymer control gear housing.

-Complete with PA66 IP68 plug for fast easy electrical connection, suitable for 3 x 2,5 mm2 cable ø 9-14 mm.

-Electronic control gear for 120-277 V, 50/60 Hz supply.

-Anti-ageing silicone gaskets.

-Stainless steel external screws."

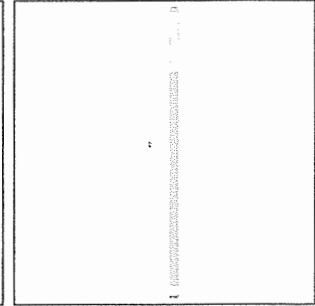
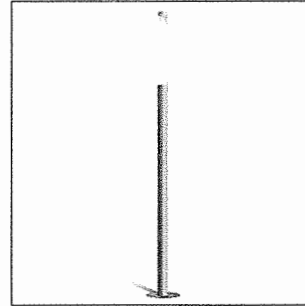

SOCKET	POWER (W)	FINISH	IP	KELVIN	OPTIC TYPE	OPTIC BEAM	DELIVERED LUMENS (L90)	LIFETIME	CULUS	UL	VOLTAGE	CODE
<b>COMPACT FLUORESCENT 120 V</b>												
2G11	1x24/55 W	IRON GRAY	IP 66	-	C/EW	-	-	-	*	-	-	<b>076338</b>
2G11	1x24/55 W	STAINLESS STEEL	IP 66	-	C/EW	-	-	-	*	-	-	<b>076340</b>
2G11	1x24/55 W	TEXTURED BLACK	IP 66	-	C/EW	-	-	-	*	-	-	<b>076406</b>
<b>COMPACT FLUORESCENT 277 V</b>												
2G11	1x24/55 W	IRON GRAY	IP 66	-	C/EW	-	-	-	*	-	-	<b>076342</b>
2G11	1x24/55 W	STAINLESS STEEL	IP 66	-	C/EW	-	-	-	*	-	-	<b>076344</b>
2G11	1x24/55 W	TEXTURED BLACK	IP 66	-	C/EW	-	-	-	*	-	-	<b>076408</b>

## KHA SLIM 8'2" LED

TEXTURED BLACK

STAINLESS STEEL

IRON GRAY



Body and top manufactured in AISI 316 stainless steel for marine applications, or extruded aluminium finished polyester painted Iron grey or Textured black.

-Double reflector optical system for downward light distribution below horizontal and zero upward light pollution. High efficiency comfortable glare free light is provided through indirect light distribution and the upper faceted reflector. The high performance reflector system is designed to provide an efficient light distribution based on height and area to be illuminated.

-Imax 2 x 80°.

-Integral driver and available in 3000, 4000 or 5000 degrees kelvin.

-UV stabilised high-tech technopolymer impact resistant lamp cover (PC-HT).

-Reflector in high purity aluminium provides comfortable low glare light control and avoids back reflection onto lamp for improved longevity.

-Technopolymer control gear housing.

-Complete with PA66 IP68 plug for fast easy electrical connection, suitable for 3 x 2,5 mm2 cable ø 9-14 mm.

-Electronic control gear for 120-277 V, 50/60 Hz supply.

-Anti-ageing silicone gaskets.

-Stainless steel external screws."

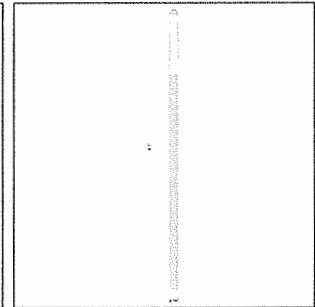
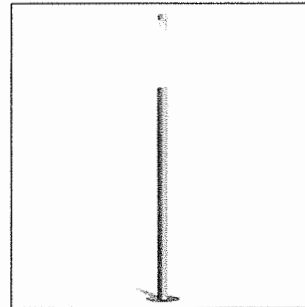

SOCKET	POWER (W)	FINISH	IP	KELVIN	OPTIC TYPE	OPTIC BEAM	DELIVERED LUMENS (L90)	LIFETIME	CULUS	UL	VOLTAGE	CODE
<b>HIGH POWER LEDS 120/277 V</b>												
LED	57 W	IRON GRAY	IP 66	3000	C/EW	-	2290 lm	-	-	-	Y	<b>076434</b>
LED	57 W	IRON GRAY	IP 66	4000	C/EW	-	2595 lm	-	-	-	Y	<b>076437</b>
LED	57 W	STAINLESS STEEL	IP 66	3000	C/EW	-	2290 lm	-	-	-	Y	<b>076435</b>
LED	57 W	STAINLESS STEEL	IP 66	4000	C/EW	-	2595 lm	-	-	-	Y	<b>076438</b>
LED	57 W	TEXTURED BLACK	IP 66	3000	C/EW	-	2290 lm	-	-	-	Y	<b>076433</b>
LED	57 W	TEXTURED BLACK	IP 66	4000	C/EW	-	2595 lm	-	-	-	Y	<b>076436</b>

## OPTIONAL ACCESSORIES

DESCRIPTION	FINISH	CODE
<b>KHA SLIM 8'2"</b> A0372 Anchor rods for in-ground concrete mounting stainless steel plate with galvanised steel rods (TYCO11 SLIM/FL only).	-	<b>14071320</b>

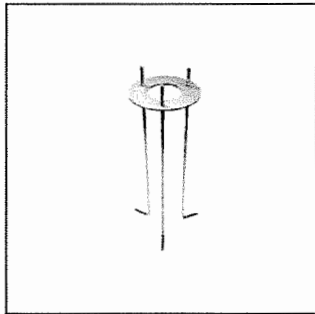

14071320

**ARBORIST REPORT  
TREE INVENTORY SUPPLEMENT  
and  
IMPACT ASSESSMENT**

**DIAMOND SPRINGS VILLAGE APARTMENTS  
PROJECT SITE  
6035 Service Drive, Diamond Springs  
County of El Dorado, California**

Prepared for:

Sergei Oleshko  
CoreCare Foundation  
8863 Greenback Lane, Suite 324  
Orangevale, California 95662

Prepared by:

Edwin E. Stirtz  
International Society of Arboriculture  
Certified Arborist WE-0510A  
ISA Tree Risk Assessment Qualified  
Member, American Society of Consulting Arborists

Acorn Arboricultural Services, Inc.  
P.O. Box 401  
Roseville, California 95678

May 2, 2018

APPROVED  
EL DORADO COUNTY  
~~PLANNING COMMISSION~~  
Board of Supervisors  
DATE: August 14, 2018

Exhibit N

BY: Roger Trent/Cret  
EXECUTIVE SECRETARY

**TABLE OF CONTENTS**

COPYRIGHT STATEMENT ..... i

QUALIFICATION STATEMENT ..... ii

INTRODUCTION ..... 1

SCOPE OF INVENTORY EFFORT ..... 1

METHODOLOGY ..... 1

SUMMARY OF INVENTORY EFFORT ..... 2

Recommended Removals..... 3

REVIEW OF ARBORIST’S REPORT (DATED APRIL 18, 2017) ..... 3

ADDITIONAL COMMENTS ON ARBORIST’S REPORT (DATED APRIL 18, 2017)..... 4

COMMENTS AND ARBORISTS’ DISCLAIMER ..... 4

ASSUMPTIONS AND LIMITING CONDITIONS ..... 6

DEFINITIONS..... 8

TREE CONDITION RATING CRITERIA..... 9

APPENDICES:

- A. Tree Inventory Supplement (sorted by tree number)
- B. Tree Inventory Exhibits (Black Rice Road only)

## **COPYRIGHT STATEMENT**

This consultant's report, dated May 2, 2018, is for the exclusive and confidential use of CoreCare Foundation concerning potential development of the Diamond Springs Village Apartments Project Site, located at 6035 Service Drive, in Diamond Springs, California. Any use of this report, the accompanying appendices, or portions thereof, other than for project review and approval by appropriate governmental authorities, shall be subject to and require the written permission of Acorn Arboricultural Services. Unauthorized modification, distribution and/or use of this report, including the data or portions thereof contained within the accompanying appendices, is strictly prohibited.

## **QUALIFICATION STATEMENT**

Acorn Arboricultural Services, Inc. is a fully insured, Roseville-based arboriculture consulting firm founded by its Principal, Jay Bate. Edwin E. Stirtz is an ISA Certified Arborist and a member of the American Society of Consulting Arborists and International Society of Arboriculture. Mr. Stirtz possesses in excess of 30 years of experience in horticulture and arboriculture, both maintenance and construction, and has spent the last 23 years as a consulting and preservation specialist in the Sacramento and surrounding regions.



## **INTRODUCTION**

Acorn Arboricultural Services is pleased to present this Arborist Report, Tree Inventory Supplement and Impact assessment for the trees located within and/or overhanging the Diamond Springs Village Apartments Project Site, located at 6035 Service Drive in Diamond Springs, California. This Arborist Report, Tree Inventory Supplement, and Impact Assessment has been prepared for the CoreCare Foundation in an effort to provide a guide to aid in the development of this site. The Tree Inventory Supplement documents tree data obtained by Edwin E. Stirtz, ISA Certified Arborist WE-0510A, at the time of field reconnaissance and inventory efforts on May 1, 2018 for trees located on Black Rice Road. An Oak Tree Survey, Preservation & Replacement Plan prepared by Natural Investigations Company and dated April 2017 was provided to evaluate for comparison to The County of El Dorado's revised Oak Resource Management Plan (ORMP) and Oak Resource Conservation Ordinance (ORCO), which was adopted on October 24, 2017. The Natural Investigations Replacement Plan was prepared prior to the implementation of the new ordinance and Core Care Foundation has requested a review of the Replacement Plan for consistency with the revised ordinance and how the revised ORMP/ORCO may impact it.

## **SCOPE OF INVENTORY EFFORT**

A tree inventory was performed on the project site in April 2017. This report documents data collected on additional trees along Black Rice Road (between Wimbledon Drive and Highway 49. Oak trees along this section 5 inches (10 inches for multi-stem trees) or more measured at 54 inches above ground level (diameter at standard height/DSH) were included in the inventory effort. Non-oak trees were noted on the Tree Inventory Field Exhibit, but not tagged or inventoried. There are various small trees (<5 inches) and shrubs along this section which were not tagged or included within this inventory.

## **METHODOLOGY**

During field reconnaissance and inventory efforts on May 1, 2018, Edwin E. Stirtz of Acorn Arboricultural Services conducted a visual review from ground level of the trees within and/or overhanging Black Rice Road. The proposed improvements to this area include widening the road from 20 feet to 24 feet and adding a 6-foot wide sidewalk along the south side of this road. The trees which met the defined criteria were identified in the field by affixing pre-stamped, round, aluminum number tags to the tree trunks. The tree numbers utilized in this report and accompanying Tree Inventory Supplement correspond to the tree tags which were affixed to the trees in the field, and those tree numbers or grouping of numbers have been digitized on an aerial Tree Inventory Field Exhibit to document the trees general locations.

At the time of field identification and inventory efforts specific data was gathered for each tagged tree including the tree’s species, diameter measured at breast height (“DBH”) and dripline radius (“DLR”). Utilizing this data the tree’s overall structural condition and vigor were separately assessed ranging from “excellent”<sup>1</sup> to “poor” based upon the observed characteristics noted within the tree and the Arborist’s best professional judgment. Ratings are subjective and are dependent upon both the structure and vigor of the tree. The vigor rating considers factors such as foliage size, color and density; the amount of deadwood within the canopy; bud viability; evidence of reaction growth; and the presence or evidence of stress, disease, nutrient deficiency and insect infestation. The structural rating reflects the root crown/collar, trunk and branch configurations; canopy balance; the presence of included bark, weak crotches and other structural defects and decay and the potential for structural failure. Finally, notable characteristics were documented and recommendations on a tree-by-tree basis were made which logically followed the observed characteristics noted within the trees at the time of the field inventory effort. These recommendations and maintenance specifications are based on the typical requirements for the age and species of each tree as well as the condition of the tree in terms of a normal shape and structure for the species.

**SUMMARY OF INVENTORY EFFORT**

Field reconnaissance and inventory efforts found 11 trees measuring 5 inches in diameter and larger measured at breast height within and/or overhanging the proposed project area. Composition of the 11 inventoried trees includes the following species and accompanying aggregate diameter inches:

SPECIES DIVERSIFICATION			
Interior Live Oak	=	9 trees	(158 aggregate diameter inches)
Blue Oak	=	2 tree	(49 aggregate diameter inches)
<b>TOTAL</b>	=	<b>11 trees</b>	<b>(207 aggregate diameter inches)</b>

---

<sup>1</sup> It is rare that a tree qualifies in an “excellent” category, and it should be noted that there were no trees observed within the project area which fell within the criteria of an “excellent” or “good” rating. A complete description of the definitions and ratings utilized in this report and accompany inventory summary are found on pages 8-9.

**Recommended Removals**

At this time, one individual tree has been recommended for removal from the proposed project area due to the nature and extent of defects, compromised health, and/or structural instability noted at the time of field inventory efforts. For reference, the tree which has been recommended for removal due to the severity of noted defects, compromised health, and/or structural instability is highlighted in green within the accompanying Tree Inventory Summary and briefly summarized as follows:

TREE #	COMMON NAME	SPECIES	MULTI-STEMS (inches)	TOTAL DBH (inches)	DLR (feet)	CONDITIONAL ASSESSMENT		PRIORITY
						STRUCTURE	VIGOR	
774	Interior Live Oak	<i>(Quercus wislizeni)</i>	13,14	27	16	Poor	Poor	1

It is important to note that under the revised ORMP/ORCO, only Valley Oaks (*Quercus lobata*) need to be mitigated for this project type. Therefore, the removal recommended above does not require mitigation. There may be other inventoried trees along Black Rice Road that require removal to implement the proposed widening and improvements. Since none of the trees in the Supplemental Tree Inventory are Valley Oaks, none should require mitigation should they need to be removed. This statement does not apply to the original Tree Inventory performed in April 2017 where Valley Oaks were inventoried.

**REVIEW OF NATURAL INVESTIGATIONS REPLACEMENT PLAN (DATED APRIL 18, 2017)**

An Oak Tree Survey, Preservation and Replacement Plan prepared by Natural Investigations Co. dated April 18, 2017 concluded that the project site is "...dominated by annual grassland habitats. Remnants of mixed oak-conifer woodlands and a small riparian corridor and associated wetlands are interspersed within the grasslands." It also concluded that "The percentage of oak species in the canopy is greater than the 10% threshold to define it as oak woodland; thus the woodland is an oak woodland as defined by County regulations."

The author stated that "the Property is subject to Canopy Retention and Replacement because the Property is greater than 1 acre and it contains more than 1 percent oak canopy cover." The calculated area of oak canopy to be removed was 0.110 acres, approximately 10% of the total oak canopy. The 90% retention standard was met.

The revision to the El Dorado County Oak Resource Management Plan (ORMP) and Oak Resource Conservation Ordinance (ORCO; adopted October 24, 2017) does not change the original impact assessment. Since the canopy impacts are to Valley Oak trees the mitigation requirement of 22 new oak trees is still mandated by the ordinance.

**ADDITIONAL COMMENTS ON ARBORIST'S REPORT (DATED APRIL 18, 2017)**

The report correctly states that Tree 78 is a Heritage tree (as defined by the ORMP/ORCO). The current condition of this tree is summarized below:

TREE #	COMMON NAME	SPECIES	TOTAL DBH (inches)	DLR (feet)	CONDITIONAL ASSESSMENT					
					ROOT CROWN	TRUNK	LIMBS	FOLIAGE	STRUCTURE	VIGOR
78	Valley Oak	<i>(Quercus lobata)</i>	46	50	Fair	Poor	Poor to fair	Dormant	Poor	Fair

Should the tree be retained, we recommend that additional examination of the tree take place prior to development. This should include an aerial inspection, decay inspection, and root crown inspection. Trees in this condition may be suited for intensive preservation efforts such as cabling, canopy reduction, and cleaning. Risk to humans may be mitigated by restricting access under it. Should the client decide to remove this tree, it meets the El Dorado County ORMP/ORCO criteria of “dead, dying or diseased” and should be exempt from mitigation requirements.

All recommendations are based on the current, applicable American National Standards Institute Standards (ANSI) for tree care activities (ANSI A300 (Part 1) – 2017) and all work performed under these specifications shall comply with the ANSI A300 standards and the International Society of Arboriculture Best Management Practices for pruning. All tree maintenance activities shall comply with ANSI Z133-2012 Safety requirements for Arboricultural Operations.

**SUMMARY**

No new mitigation required for Black Rice Road widening. No change in previous mitigation for on-site Oak Woodland/Individual Oak Impacts, 22 trees (based on 0.110 ac impact per Natural Investigations) which = \$3,366.00 (\$153 per/inch) or \$911 using the acreage replacement calculation.

**COMMENTS AND ARBORISTS' DISCLAIMER**

The County of El Dorado regulates the removal of “protected trees” and prior to any tree removal it should be determined which if any trees proposed for removal require a tree permit which may then be obtained from the County.

Please bear in mind that implementation of the recommendations provided within this report will help to reduce risk associated with trees however, implementation of any

recommendations should not be viewed as a guarantee or warranty against the trees' ultimate demise and/or failure in the future. Arborists are tree specialists who use their education, knowledge, training and experience to examine trees, recommend measures to enhance the beauty and health of the trees and *attempt to reduce the risk of living near trees*. Arborists cannot detect every condition that could possibly lead to the structural failure of a tree. There are some inherent risks with trees that cannot be predicted with any degree of certainty, even by a skilled and experienced arborist. Individuals who choose to live in treed areas accept a certain level of risk from unpredictable tree related hazards such as toppling in storms and limbs falling that may damage property at some time in the future. Since trees are living organisms their structure and vigor constantly change over time, and they are not immune to changes in site conditions or seasonal variations in the weather. Further, conditions are often hidden within the tree and/or below ground. Arborists and other tree care professionals cannot guarantee that a tree will be healthy and/or safe under all circumstances or for a specific period of time. Likewise remedial treatments cannot be guaranteed. Trees can be managed but they cannot be controlled. To develop land and live near trees is to accept some degree of risk and the only way to eliminate all risk associated with trees would be to eliminate all of the trees. Acorn Arboricultural Services cannot predict acts of nature including, without limitation, storms of sufficient strength which can even take down a tree with a structurally sound and vigorous appearance.

Finally, the trees included in the Diamond Springs Village Apartments Project Site should be regularly monitored on an annual basis as well as after significant storm events. As trees age, the likelihood of failure of branches or entire trees increases and occasional pruning, fertilization, mulch, pest management, replanting and/or irrigation may be required and annual inspections can often identify these items prior to a significant. Therefore, *the future management plan must include an annual inspection* by a qualified ISA Certified Arborist to keep abreast of the trees' changing condition(s) and to assess the trees' ongoing structural integrity and potential for hazard in a developed environment.

Thank you for allowing Acorn Arboricultural Services to assist you with this tree inventory and maintenance specification. Please feel free to give me a call if you have any questions or require additional information and/or clarification.

Sincerely,

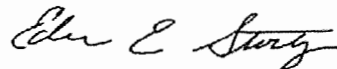

Edwin E. Stirtz  
International Society of Arboriculture  
Certified Arborist WE-0510A  
ISA Tree Risk Assessment Qualified  
Member, American Society of Consulting Arborists

### **ASSUMPTIONS AND LIMITING CONDITIONS**

1. Any legal description provided to the consultant is assumed to be correct. Any titles and ownership to any property are assumed to be good and marketable. No responsibility is assumed for matters legal in character. Any and all property is appraised or evaluated as though free and clear, under responsible ownership and competent management.
2. It is assumed that any property is not in violation of any applicable codes, ordinances, statutes, or other governmental regulations.
3. Care has been taken to obtain all information from reliable sources. All data has been verified insofar as possible; however, the consultant can neither guarantee nor be responsible for the accuracy of information provided by others.
4. The consultant shall not be required to give a deposition and/or attend court by reason of this report unless subsequent contractual arrangements are made for in advance, including payment of an additional fee for such services according to our standard fee schedule, adjusted yearly, and terms of the subsequent contract of engagement.
5. Loss or alteration of any part of this report invalidates the entire report. Ownership of any documents produced passes to the Client only when all fees have been paid.
6. Possession of this report or a copy thereof does not imply right of publication or use for any purpose by any other than the person to whom it is addressed, without the prior expressed written or verbal consent of the consultant.
7. Neither all nor any part of the contents of this report, nor copy thereof, shall be conveyed by anyone, including the client, to the public through advertising, public relations, news, sales, or other media, without the prior expressed written or verbal consent of the consultant, particularly as to value conclusions, identity of the consultant, or any reference to any professional society or institute or to any initialed designation conferred upon the consultant as stated in his qualifications.
8. This report and any values expressed herein represent the opinion of the consultant and the consultant's fee is in no way contingent upon the reporting of a specified value, a stipulated result, the occurrence of a subsequent event, nor upon any finding to be reported.
9. Sketches, diagrams, graphs, drawings and photographs within this report are intended as visual aids and are not necessarily to scale and should not be construed as engineering or architectural reports or surveys. The reproduction of information generated by other consultants is for coordination and ease of

reference. Inclusion of such information does not constitute a representation by the consultant as to the sufficiency or accuracy of the information.

10. Unless expressed otherwise: 1) information contained in this report covers only those items that were examined and reflects the condition of those items at the time of inspection; and 2) the inspection is limited to visual examination of accessible items without laboratory analysis, dissection, excavation, probing or coring, unless otherwise stated.
11. There is no warranty or guarantee, expressed or implied, that problems or deficiencies of the plants or property in question may not arise in the future.
12. This report is based on the observations and opinions of Edwin E. Stirtz, and does not provide guarantees regarding the future performance, health, vigor, structural stability or safety of the plants described herein. Neither this author nor Acom Arboricultural Services has assumed any responsibility for liability associated with the trees on or adjacent to this Project Site, their future demise and/or any damage which may result therefrom.
13. The information contained within this report is true to the best of the author's knowledge and experience as of the date it was prepared; however, certain conditions may exist which only a comprehensive, scientific, investigation might reveal which should be performed by other consulting professionals.
14. The legal description, dimensions, and areas herein are assumed to be correct. No responsibility is assumed for matters that are legal in nature.
15. Any changes to an established tree's environment can cause its decline, death and/or structural failure.

## **DEFINITIONS**

Tree Number:	Corresponds to aluminum tag attached to the tree.
Species Identification:	Scientific and common species name.
Diameter (“DSH”):	This is the trunk diameter measured at standard height (industry standard 4.5 feet above ground level).
Dripline radius (“DLR”):	A radius equal to the horizontal distance from the trunk of the tree to the end of the farthest most branch tip prior to any cutting. When depicted on a map, the dripline will appear as an irregularly shaped circle that follows the contour of the tree’s branches as seen from overhead.
Protected Zone:	A circle equal to the largest radius of a protected tree’s dripline plus 1 foot.
Root Crown:	Assessment of the root crown/collar area located at the base of the trunk of the tree at soil level.
Trunk:	Assessment of the tree’s main trunk from ground level generally to the point of the primary crotch structure.
Limbs:	Assessment of both smaller and larger branching, generally from primary crotch structure to branch tips.
Foliage:	Tree’s leaves.
Overall Condition:	Describes overall condition of the tree in terms of structure and vigor.
Recommendation:	Pre-development recommendations based upon observed characteristics noted at the time of the field inventory effort.
Obscured:	Occasionally some portion of the tree may be obscured from visual inspection due to the presence of dense vegetation which, during the course of inspection for the arborist report, prevented a complete evaluation of the tree. In these cases, if the tree is to be retained on site the vegetation should be removed to allow for a complete assessment of the tree prior to making final decisions regarding the suitability for retention.



**TREE CONDITION RATING CRITERIA**

RATING TERM	ROOT CROWN	TRUNK	LIMBS	FOLIAGE	STRUCTURE	VIGOR
Good	No apparent injuries, decay, cavities or evidence of hollowing; no anchoring roots exposed; no indications of infestation or disease	No apparent injuries, decay, cavities or evidence of hollowing; no codominant attachments or multiple trunk attachments are observed; no indications of infestation or disease	No apparent injuries, decay, cavities or evidence of hollowing; below average amount of dead limbs or twigs; no major limb failures or included bark; callus growth is vigorous	Leaf size, color and density are typical for the species; buds are normal in size, viable, abundant and uniform throughout the canopy; annual seasonal growth increments are average or above average; no insect or disease infestations/ infections evident	No apparent structural defects; no weak crotches; no excessively weighted branches and no significant cavities or decay	Tree appears healthy and has little or no significant deadwood; foliage is normal and healthy
Fair	Small to moderate injuries, decay, cavities or hollowing may be evident but are not currently affecting the overall structure; some evidence of infestation or disease may be present but is not currently affecting the tree's structure	Small to moderate injuries, decay, cavities or hollowing may be evident; codominant branching or multiple trunk attachments or minor bark inclusion may be observed; some infestation or disease may be present but not currently affecting the tree's structure	Small to moderate injuries, decay or cavities may be present; average or above average dead limbs or twigs may be present; some limb failures or bark inclusion observed; callus growth is average	Leaf size, color and density are typical or slightly below typical for the species; buds are normal or slightly sparse with potentially varied viability, abundance and distribution throughout the canopy; annual seasonal growth increments are average or slightly below average; minor insect or disease infestation/infection may be present	Minor structural problems such as weak crotches, minor wounds and/or cavities or moderate amount of excessive weight; non-critical structural defects which can be mitigated through pruning, cabling or bracing	Tree appears stressed or partially damaged; minimal vegetative growth since previous season; moderate amount of deadwood, abnormal foliage and minor lesions or cambium dieback
Poor	Moderate to severe injuries, decay, cavities or hollowing may be evident and are affecting the overall structure; presence of infestation or disease may be significant and affecting the tree's structure	Moderate to severe injuries, decay, cavities or hollowing may be evident and are affecting the tree's structure; presence of infestation or disease may be significant and affecting the tree's structure	Severe injuries, decay or cavities may be present; major deadwood, twig dieback, limb failures or bark inclusion observed; callus growth is below average	Leaf size, color and density are obviously abnormal; buds are obviously abnormal or absent; annual seasonal growth is well below average for the species; insect or disease problems may be severe	Obvious major structural problems which cannot be corrected with mitigation; potential for major limb, trunk or root system failure is high; significant decay or dieback may be present	Tree health is declining; no new vegetative growth; large amounts of deadwood; foliage is severely abnormal

The ratings "good to fair" and "fair to poor" are used to describe trees that fall between the described major categories and have elements of both

Tree Inventory Supplement  
 Core Care Foundation  
 Diamond Springs Village Apartments  
 Co. of El Dorado, CA

TREE #	COMMON NAME	SPECIES	MULTI-STEMS (inches)	TOTAL DBH INCHES	DLR (ft=0)	CONDITIONAL ASSESSMENT						NOTABLE CHARACTERISTICS	MAINTENANCE RECOMMENDATIONS
						RT CR	TRUNK	LIMBS	FOLIAGE	STRUCTURE	VIGOR		
768	Interior Live Oak	( <i>Quercus wislizeni</i> )	5,6,7	18	12	Poor-fair	Poor-fair	Poor-fair	Fair	Poor-fair	Fair	Callousing basal trunk cavity, partial stem fai	None at this time
769	Interior Live Oak	( <i>Quercus wislizeni</i> )	8,8	16	13	Poor-fair	Poor-fair	Fair	Fair	Poor-fair	Fair	Forks 1' above grade w/ weak attachments.	None at this time
770	Interior Live Oak	( <i>Quercus wislizeni</i> )	4,4,6	14	7	Fair	Fair	Fair	Fair	Fair	Fair	Slightly above average amount of deadwood	None at this time
771	Interior Live Oak	( <i>Quercus wislizeni</i> )	3,4,5,6,7	27	10	Poor-fair	Poor-fair	Fair	Fair	Poor-fair	Fair	Weak attachments; one-sided to the South	None at this time
772	Blue Oak	( <i>Quercus douglasii</i> )	5,6,7,7	25	12	Poor-fair	Poor-fair	Poor-fair	Fair	Poor	Fair	Callousing basal trunk wounds, moderate de	None at this time
773	Blue Oak	( <i>Quercus douglasii</i> )	3,5,4,6,6	24	15	Poor-fair	Poor-fair	Poor-fair	Fair	Poor-fair	Fair	Fork at grade to 1' above grade. Out of balan	None at this time
774	Interior Live Oak	( <i>Quercus wislizeni</i> )	13,14	27	16	Poor-fair	Poor-fair	Poor-fair	Poor	Poor	Poor	85% dead	Recommend removal due to nature and extent of noted defects.
775	Interior Live Oak	( <i>Quercus wislizeni</i> )	7,7,12	26	12	Poor-fair	Poor-fair	Fair	Fair	Poor-fair	Fair	Minor decay on S side; weak attachments, sl	None at this time
776	Interior Live Oak	( <i>Quercus wislizeni</i> )		11	13	Fair	Fair	Fair	Fair	Fair	Fair		None at this time
777	Interior Live Oak	( <i>Quercus wislizeni</i> )	6,6	12	17	Poor-fair	poor	Poor-fair	Fair	Fair	Fair		None at this time
778	Interior Live Oak	( <i>Quercus wislizeni</i> )		7	12	Fair	Fair	Fair	Fair	Fair	Fair	Slightly above average amount of deadwood	None at this time

TOTAL INVENTORIED TREES = 11 trees (207 aggregate diameter inches)
TOTAL RECOMMENDED REMOVALS = 1 tree (27 aggregate diameter inches)

# Core Care: Diamond Springs Village Apartments Black Rice Rd. Improvements Impact Assessment Tree Inventory Supplement-Field Exhibit

774 dead  
PP 16"  
BO 4"  
773  
PP 18"  
BO 5"  
BO 3"  
ILO 5.6"  
PP 7"  
BB 7"  
CB  
ILO 1 2"  
769  
768  
775  
BO 1"  
778  
777  
pp 12"  
PP 17"  
776  
PP 20"

- Key
- BB=Black brush
  - BO=Blue oak
  - CB=Coyote brush
  - ILO=Interior live oak
  - MM=Manzanita
  - MZ=Manzanita
  - PP=Ponderosa Pine

MZ  
BO 1"  
BO 17"  
PP 15"  
775  
ILO 5.7"BO 15"

Google Earth

Prepared by Acorn Arboricultural Services Inc.  
May 1, 2018

2018

