

# Revision to Ridgeview Village Unit No.9 Tentative Subdivision Map/TM08-1477-R

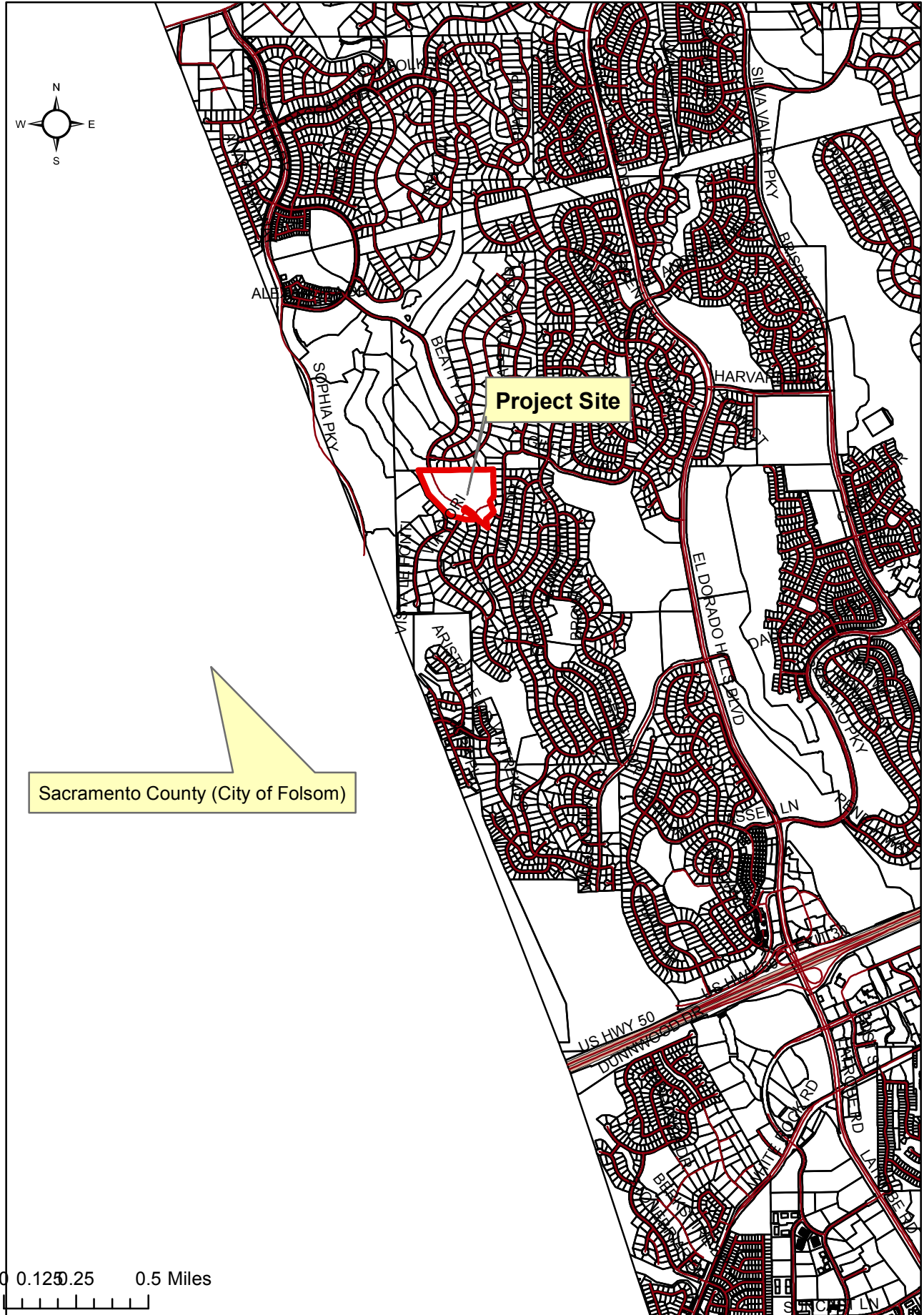

**Exhibit A: Location Map**

POR. SEC. 34, T.10N., R.8E., M.D.M.

120:01

Bk 124 Pg 11

1" equals 200'



THIS MAP IS NOT A SURVEY, it is prepared by the El Dorado Co. Assessor's office for assessment purposes only. Area calculations and characteristics are not guaranteed. Users should verify items such as dimensions and acreage.

Acreages Are Estimates

Rev. July 12, 2006

Assessor's Map Bk. 120, Pg. 01  
County of El Dorado, CA  
19-1507 D 2 of 59

EXHIBIT B

# Revision to Ridgeview Village Unit No.9 Tentative Subdivision Map/TM08-1477-R

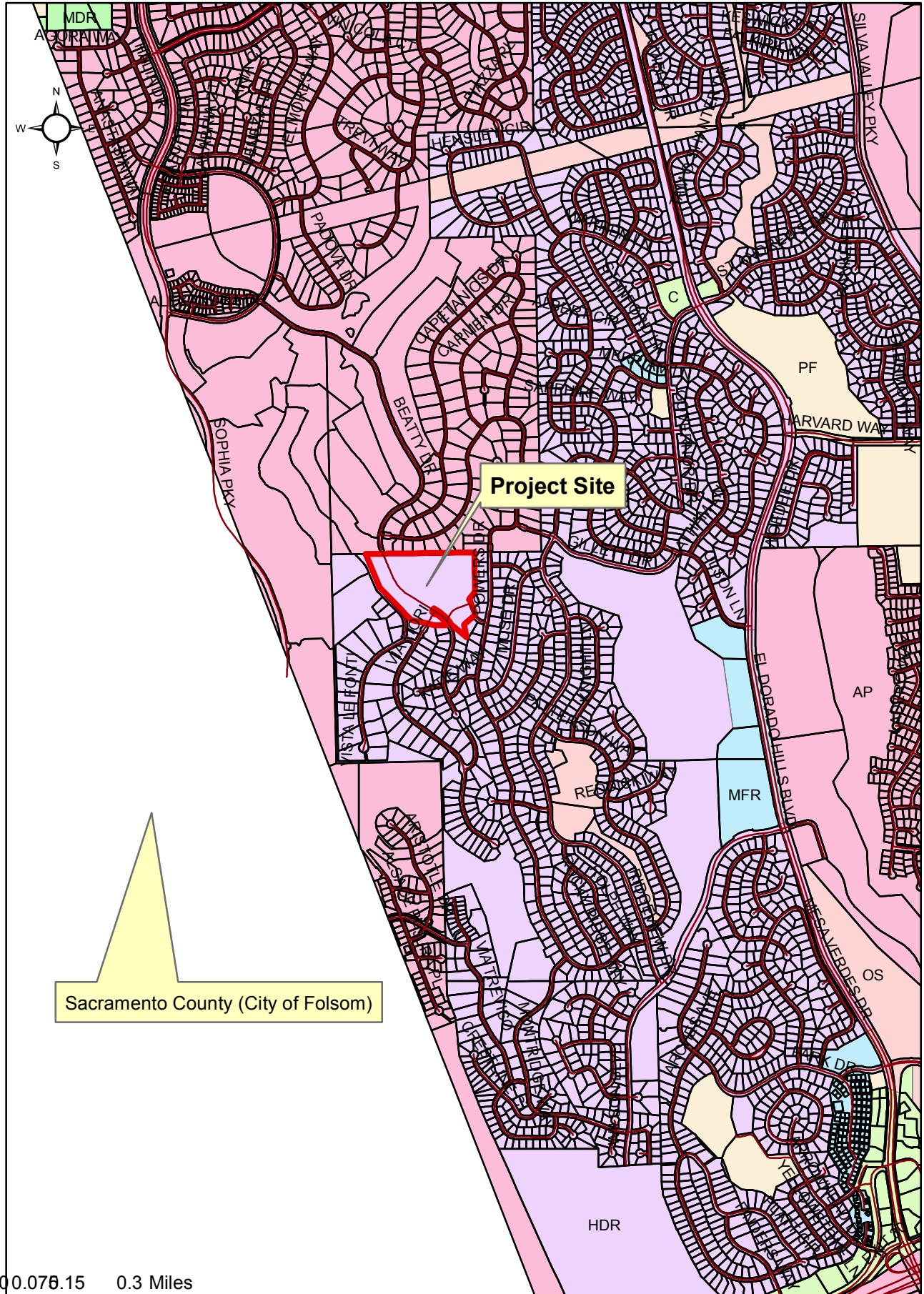

**Exhibit C: General Plan Land Use Map**



# Revision to Ridgeview Village Unit No.9 Tentative Subdivision Map/TM08-1477-R

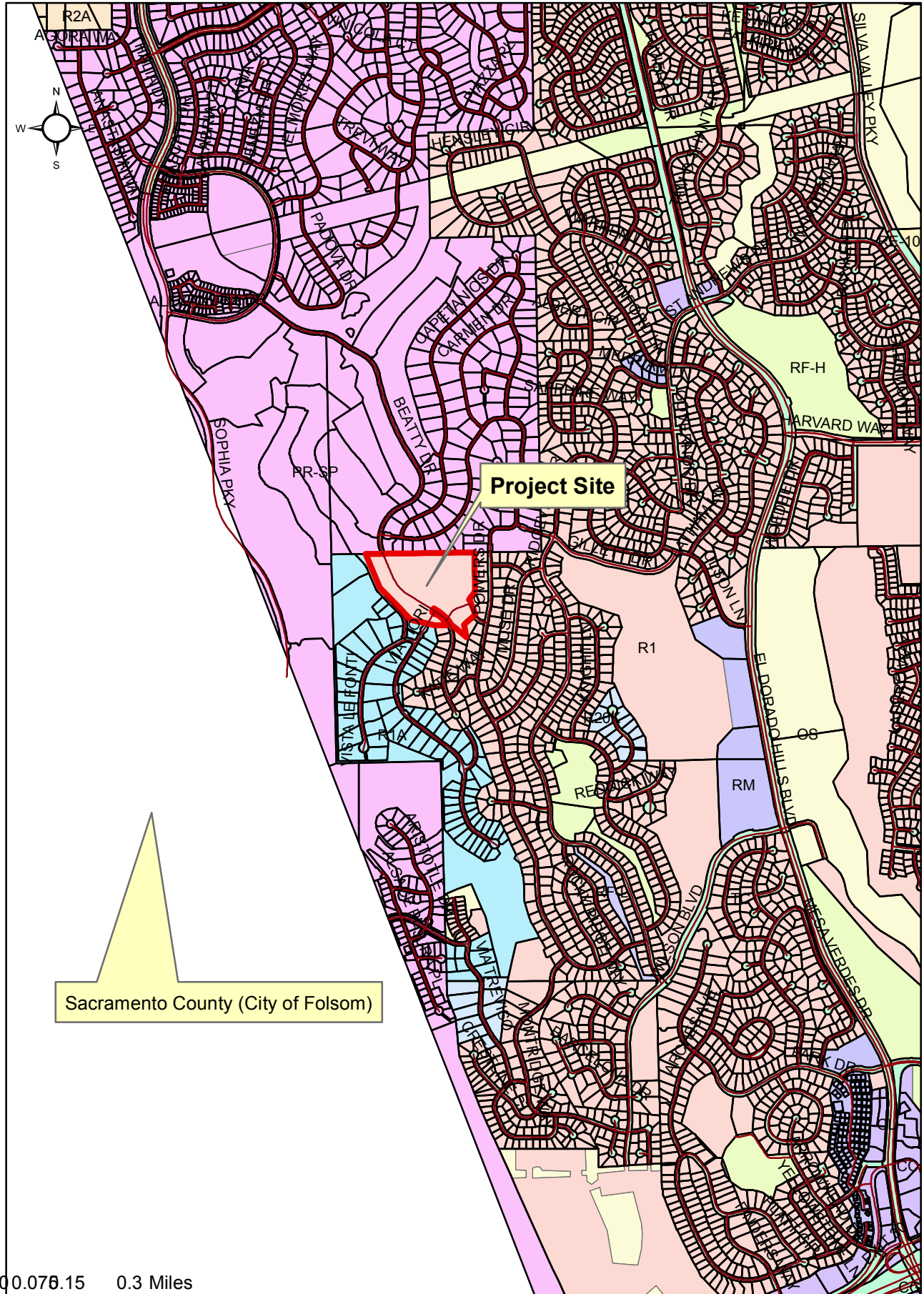

Sacramento County (City of Folsom)

**Exhibit D: Zone Map**



Z88 75

TM88-1125

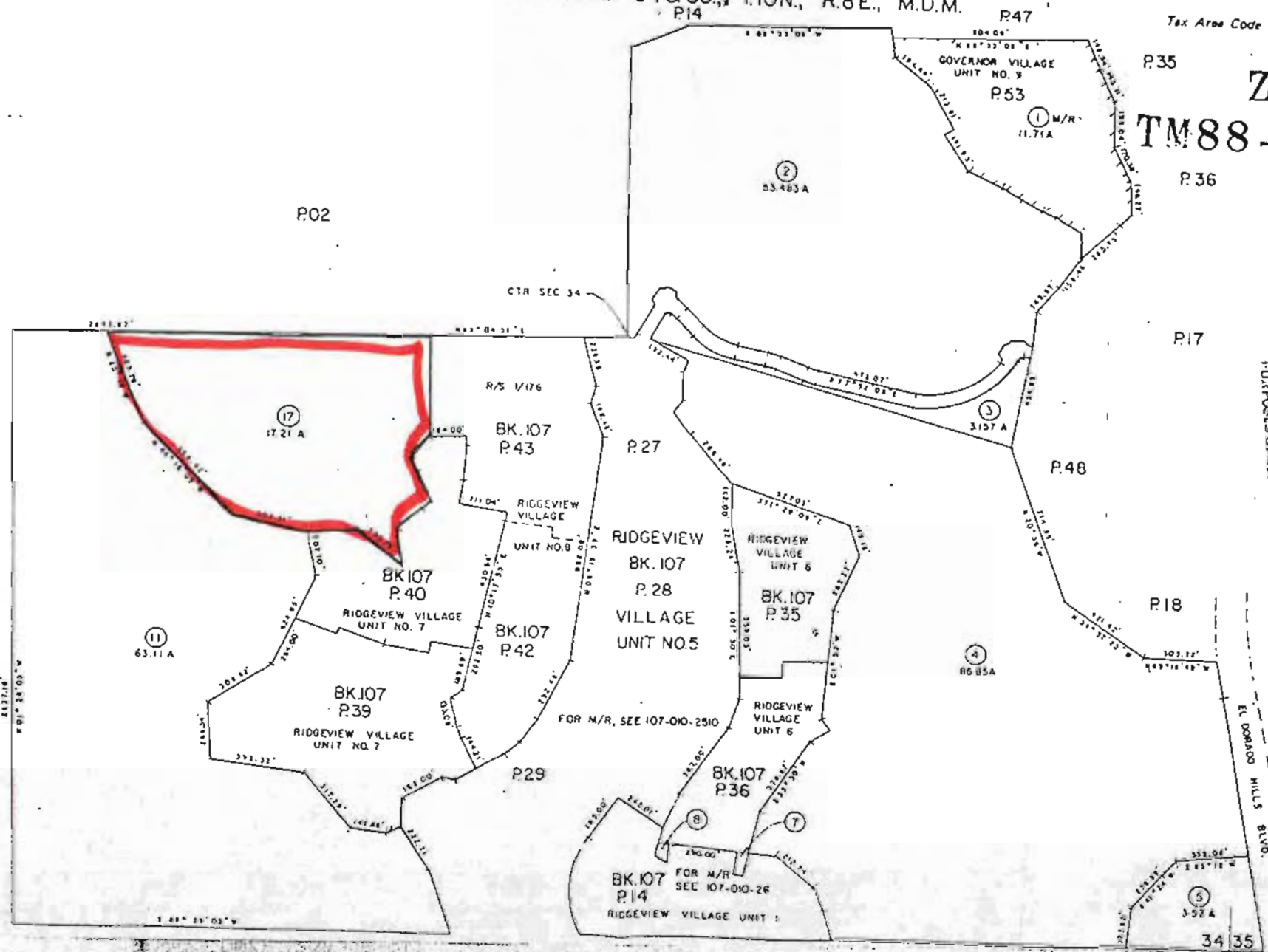

THIS MAP IS NOT A SURVEY.  
 IT IS PREPARED BY THE E.  
 DORADO CO. ASSESSOR'S  
 OFFICE FOR ASSESSMENT  
 PURPOSES ONLY.

BK.67

P02

EXHIBIT E

EXHIBIT E

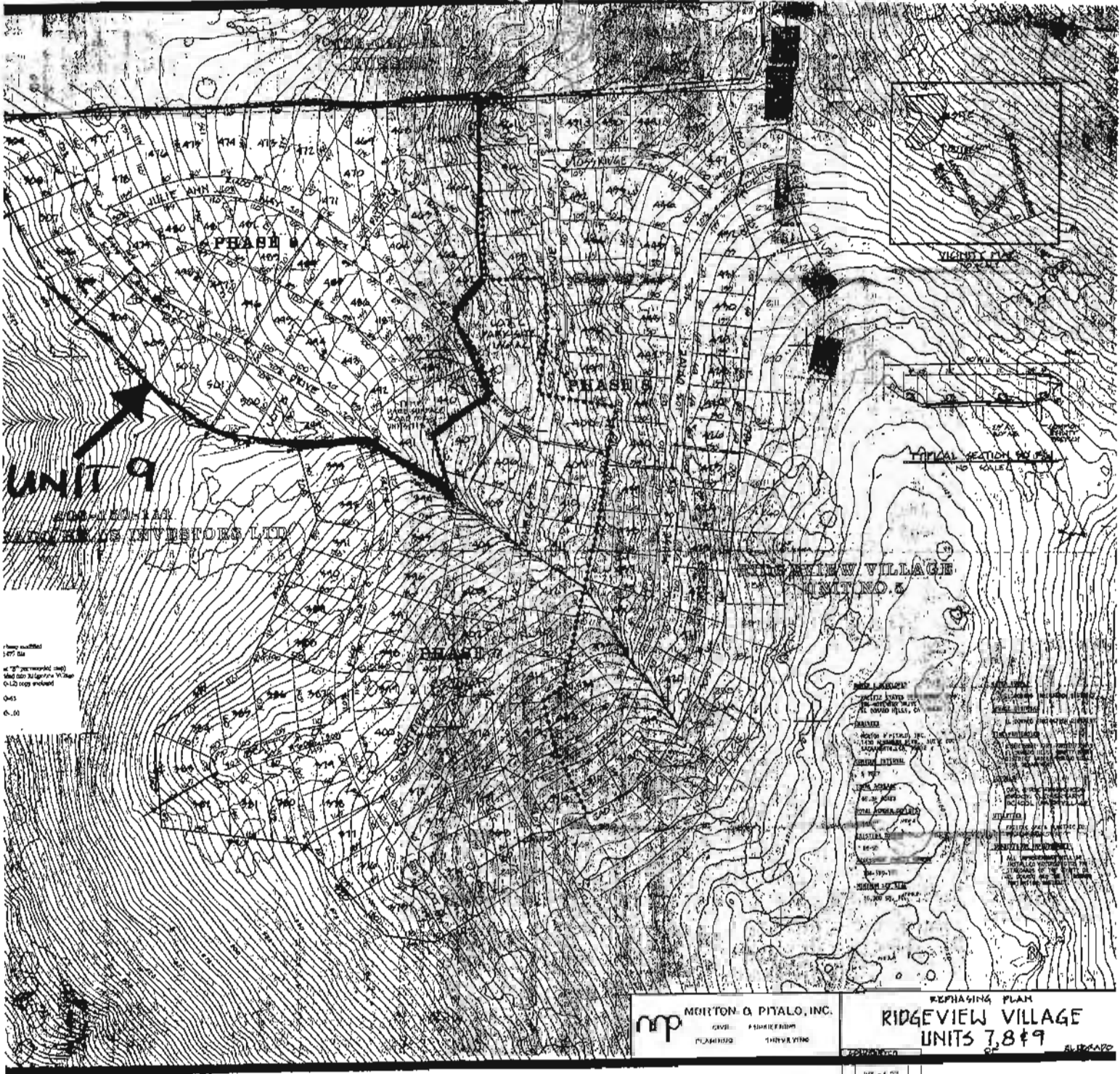

1. Survey conducted  
 1977 Data  
 at 1" horizontal scale  
 and 20' vertical scale  
 (1:20000) (1:20000)  
 0-12' slope indicated  
 0-12'  
 6.00

**m p** MORTON & PITALO, INC.  
 CIVIL ENGINEERING  
 PLANNING SURVEYING

REPHASING PLAN  
**RIDGEVIEW VILLAGE**  
**UNITS 7, 8 & 9**

MAY - 1 2011  
 MORTON & PITALO, INC.



# TENTATIVE MAP

## RIDGEVIEW VILLAGE UNIT 9

### SECTION 34, T.10 N., R.8 E., M.D.M.

COUNTY OF EL DORADO

JULY, 2013

STATE OF CALIFORNIA

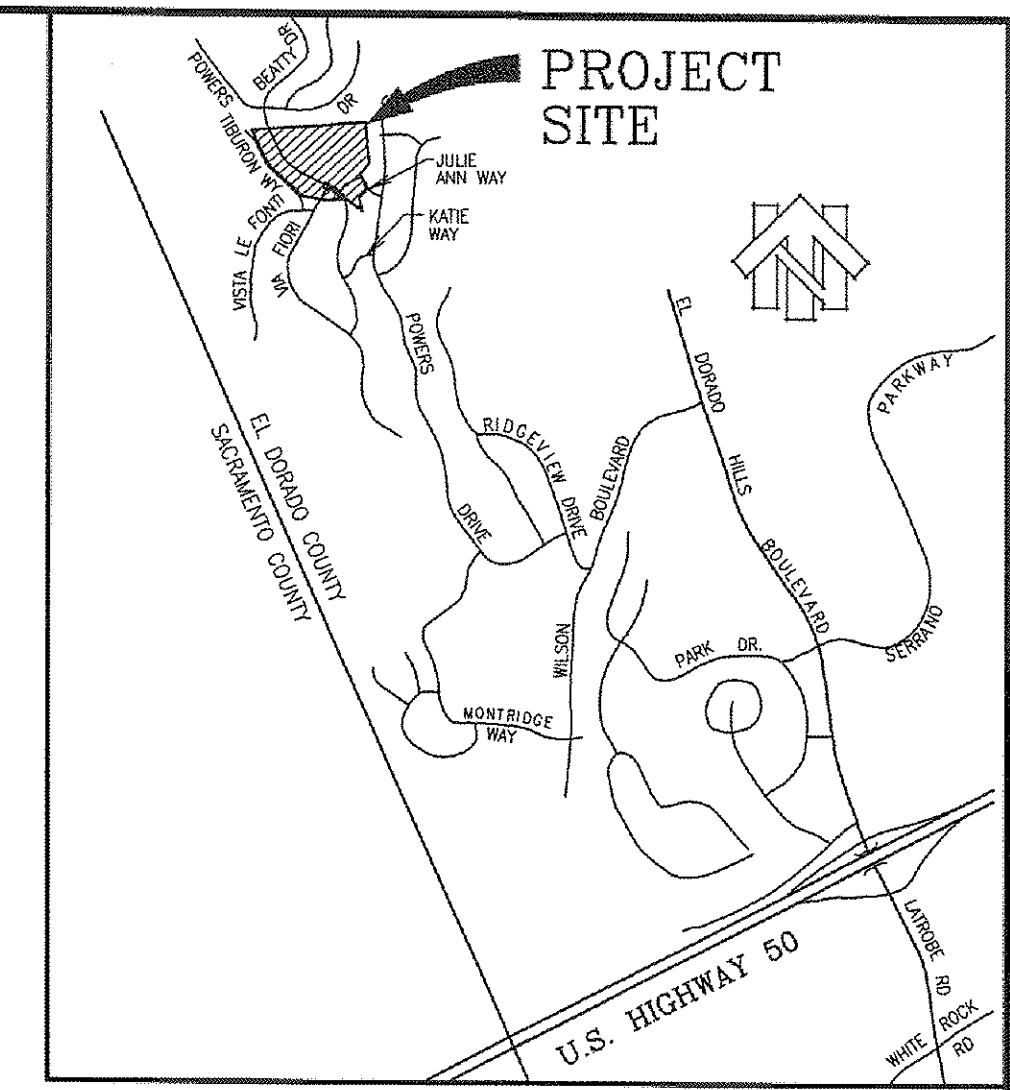

VICINITY MAP  
NOT TO SCALE

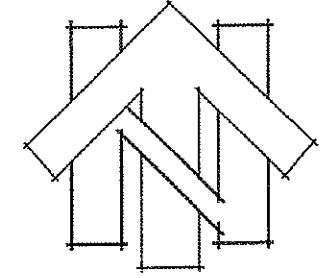

SCALE: 1" = 60'

**OWNER OF RECORD**

PACIFIC STATES DEVELOPMENT  
991 GOVERNOR DRIVE, STE. 103  
EL DORADO HILLS CA 95762

**APPLICANT**

PACIFIC STATES DEVELOPMENT  
991 GOVERNOR DRIVE, STE. 103  
EL DORADO HILLS CA 95762

**ENGINEER**

CTA Engineering - Surveying  
2333 Moorpark Circle  
Rancho Cordova CA 95772  
(916) 438-9700  
CIVIL ENGINEER No. 10000

**MAP SCALE**

1" = 60'

**CONTOUR INTERVAL**

CONTOUR INTERVAL = 1 FOOT

**SOURCE OF TOPOGRAPHY**

(AERIAL PHOTOGRAPHY/TOPOGRAPHIC SURVEY)

**SECTION, TOWNSHIP & RANGE**

SECTIONS 34, T.10N., R.8E., M.D.M.

**ASSESSOR'S PARCEL NUMBER**

A.P.N. 120-010-01

**PROPOSED ZONING**

R1

**TOTAL AREA**

22.4 ACRES

**TOTAL NO. of LOTS**

44 SINGLE FAMILY LOTS

**MINIMUM LOT AREA**

12,889 SQUARE FEET

**WATER SUPPLY and SEWAGE DISPOSAL**

WATER - EL DORADO IRRIGATION DISTRICT  
SEWER - EL DORADO IRRIGATION DISTRICT

**PROPOSED STRUCTURAL FIRE PROTECTION**

EL DORADO HILLS COUNTY WATER DISTRICT

**PHASING PLAN NOTICE**

THE SUBDIVIDER MAY FILE MULTIPLE FINAL MAPS FOR THIS PROJECT. THE SUBDIVIDER SHALL NOT BE REQUIRED TO DEFINE THE NUMBER OR CONFIGURATION OF THE PROPOSED MULTIPLE FINAL MAPS. (PER THE SUBDIVISION MAP ACT, SECTION 66456.1)

**ENGINEER'S CERTIFICATE**

I HEREBY CERTIFY THAT TO THE BEST OF MY KNOWLEDGE THE LAND DEVELOPMENT KNOWN AS "RIDGEVIEW VILLAGE UNIT 9" HAS BEEN DESIGNED IN ACCORDANCE WITH THE REGULATIONS AND GUIDELINES ESTABLISHED BY THE COUNTY OF EL DORADO.

*Olga Sciorelli*  
OLGA SCIORELLI P.E. 71204  
DATE: 7/8/13



- LEGEND:**
- PROPOSED FIRE HYDRANT
  - EXISTING WETLANDS
  - ISOLATED SEEPS (NON-JURISDICTIONAL)
  - SUBDIVISION BOUNDARY
  - RIGHT OF WAY LINE
  - LOT LINE
  - SETBACK LINE
  - NON BUILDING SETBACK
  - INTERMITTENT DRAINAGE

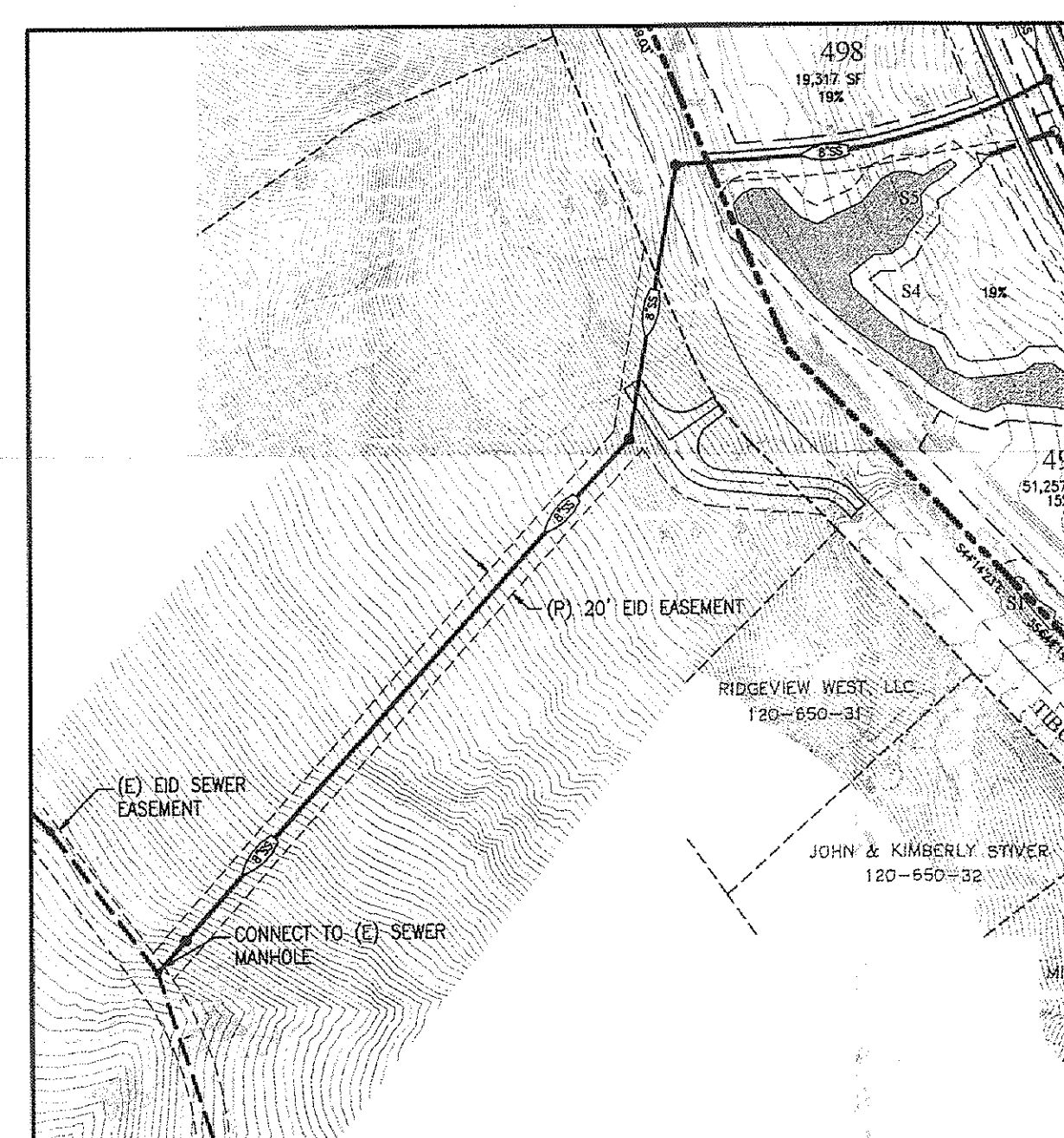

OFFSITE SEWER EXHIBIT  
SCALE: 1"=100'

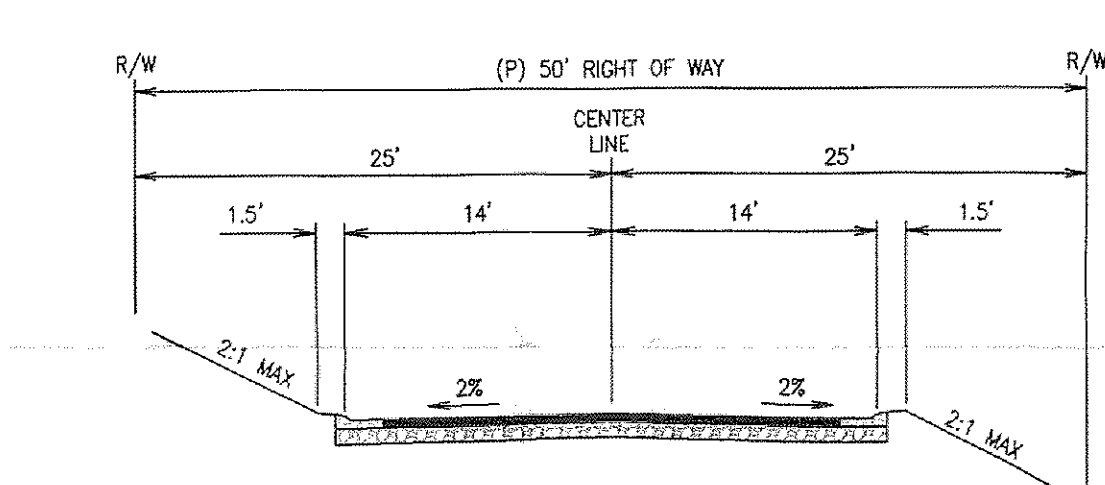

A & B COURT  
SCALE: 1"=10'

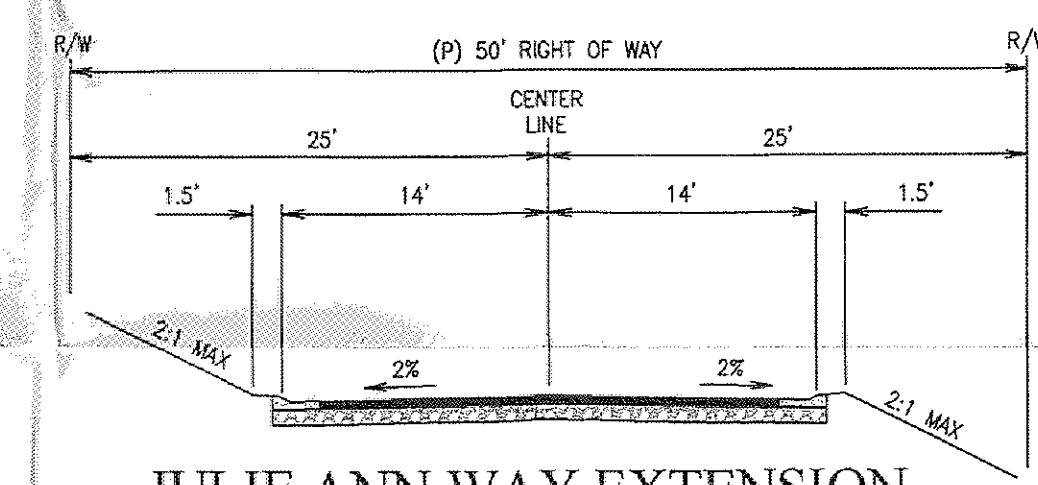

JULIE ANN WAY EXTENSION  
SCALE: 1"=10'

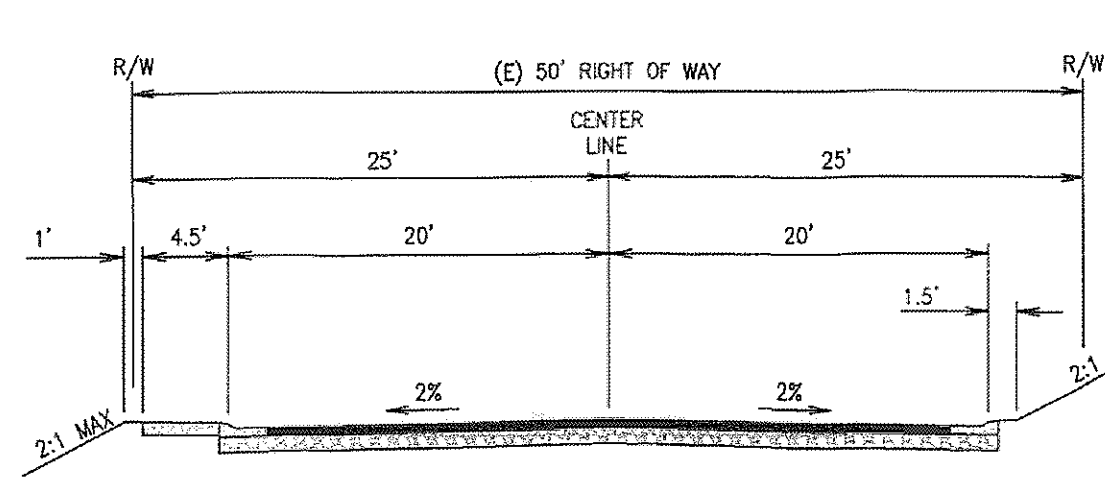

BEATTY DRIVE IMPROVEMENTS  
SCALE: 1"=100'

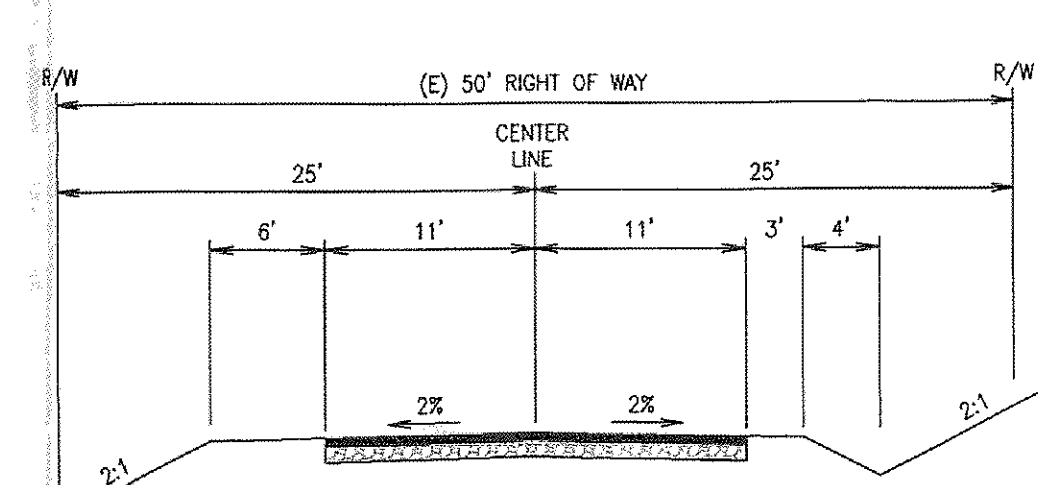

(E) BEATTY DRIVE  
SCALE: 1"=100'

EXHIBIT F

**GROSS AND NET\* LOT AREAS**

Lot No.	Gross Area (S.F.)	Net Area (S.F.)	Lot No.	Gross Area (S.F.)	Net Area (S.F.)
496	20,970	16,491	473	21,051	14,195
497	18,056	13,474	474	39,072	18,305
498	19,317	12,703	475	34,406	14,101
499	51,257	19,875	476	17,521	11,529
500	14,304	9,911	477	18,908	13,775
501	16,084	11,549	478	14,663	10,134
502	19,563	14,449	479	12,004	7,872
503	21,147	9,269	480	13,565	9,114
504	16,192	8,202	481	18,866	13,521
505	17,950	10,156	482	14,773	9,023
			483	18,866	13,521
			484	26,326	19,886
			485	13,299	9,602
			486	13,187	8,544
			487	12,950	8,736
			488	12,873	7,579
			489	20,262	13,593
			490	21,008	13,605
			491	19,296	13,605
			492	21,491	14,844
			493	12,289	7,804
			494	15,227	10,156
			495	23,230	15,177
			496	20,970	16,491
			497	18,056	13,474
			498	19,317	12,703
			499	51,257	19,875
			500	14,304	9,911
			501	16,084	11,549
			502	19,563	14,449
			503	21,147	9,269
			504	16,192	8,202
			505	17,950	10,156

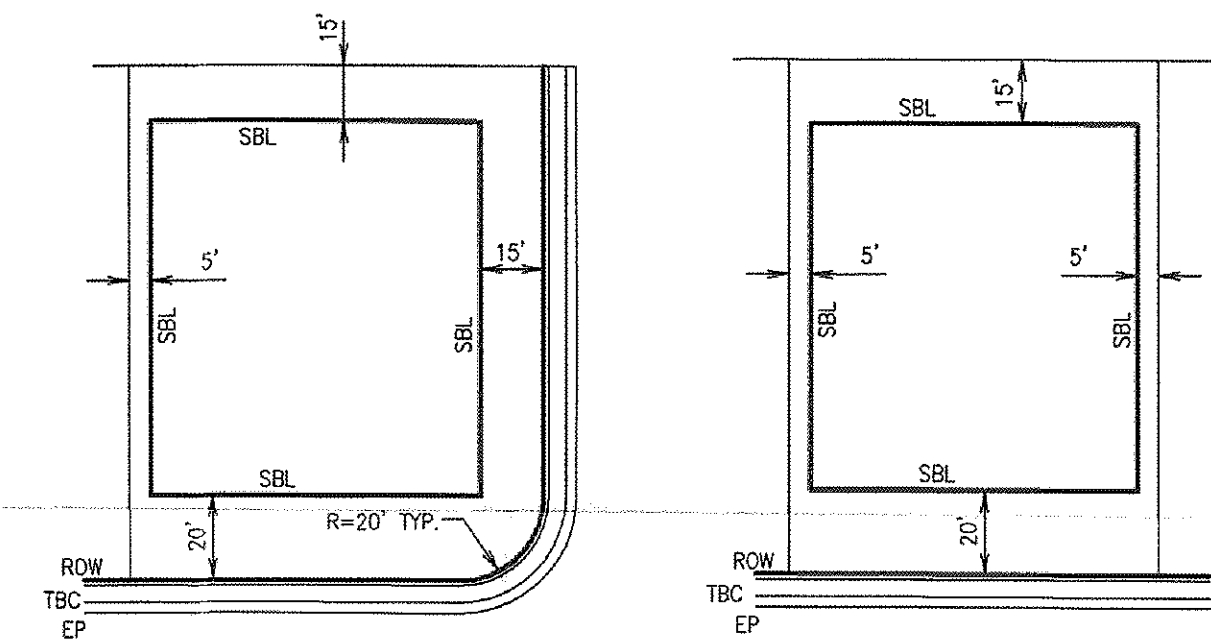

TYPICAL BUILDING SETBACKS  
ONE-FAMILY RESIDENTIAL (R1)

APPROVED  
EL DORADO COUNTY  
PLANNING COMMISSION  
DATE: July 11, 2013  
BY: Rose Neudorfer  
EXECUTIVE SECRETARY  
TMS-1477

PLANNING COMMISSION: \_\_\_\_\_  
APPROVAL/DENIAL DATE: \_\_\_\_\_  
BOARD OF SUPERVISORS: \_\_\_\_\_  
APPROVAL/DENIAL DATE: \_\_\_\_\_

\* NET AREA OF THE LOT EXCLUDES NON-BUILDABLE AREAS SUCH AS BUILDING SETBACKS, BASEMENTS, AND SLOPES ABOVE 30%.



# Revision to Ridgeview Village Unit No.9 Tentative Subdivision Map/TM08-1477-R

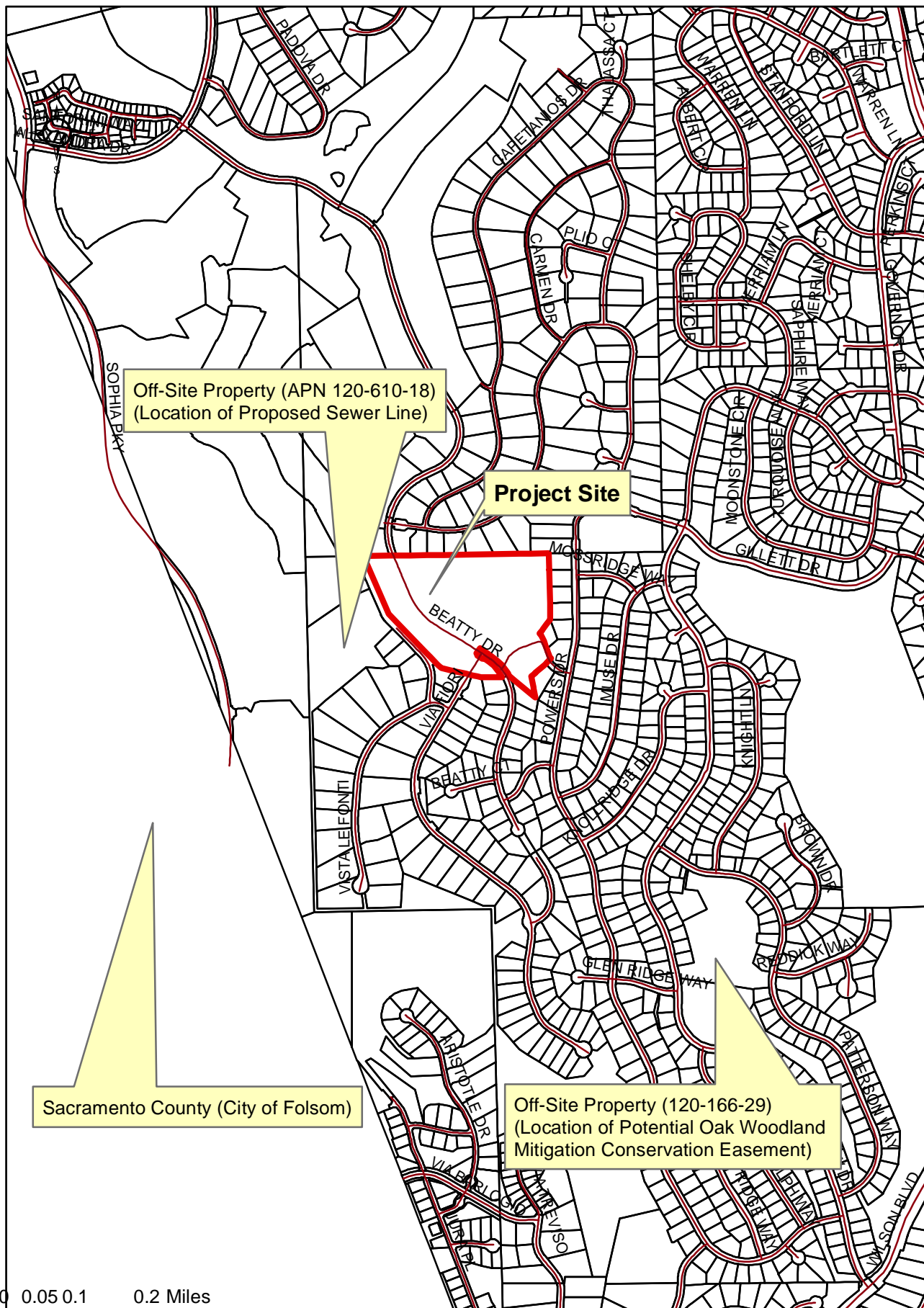

**Exhibit G: Map of Off-Site Properties**



# Revision to Ridgeview Village Unit No.9 Tentative Subdivision Map/TM08-1477-R

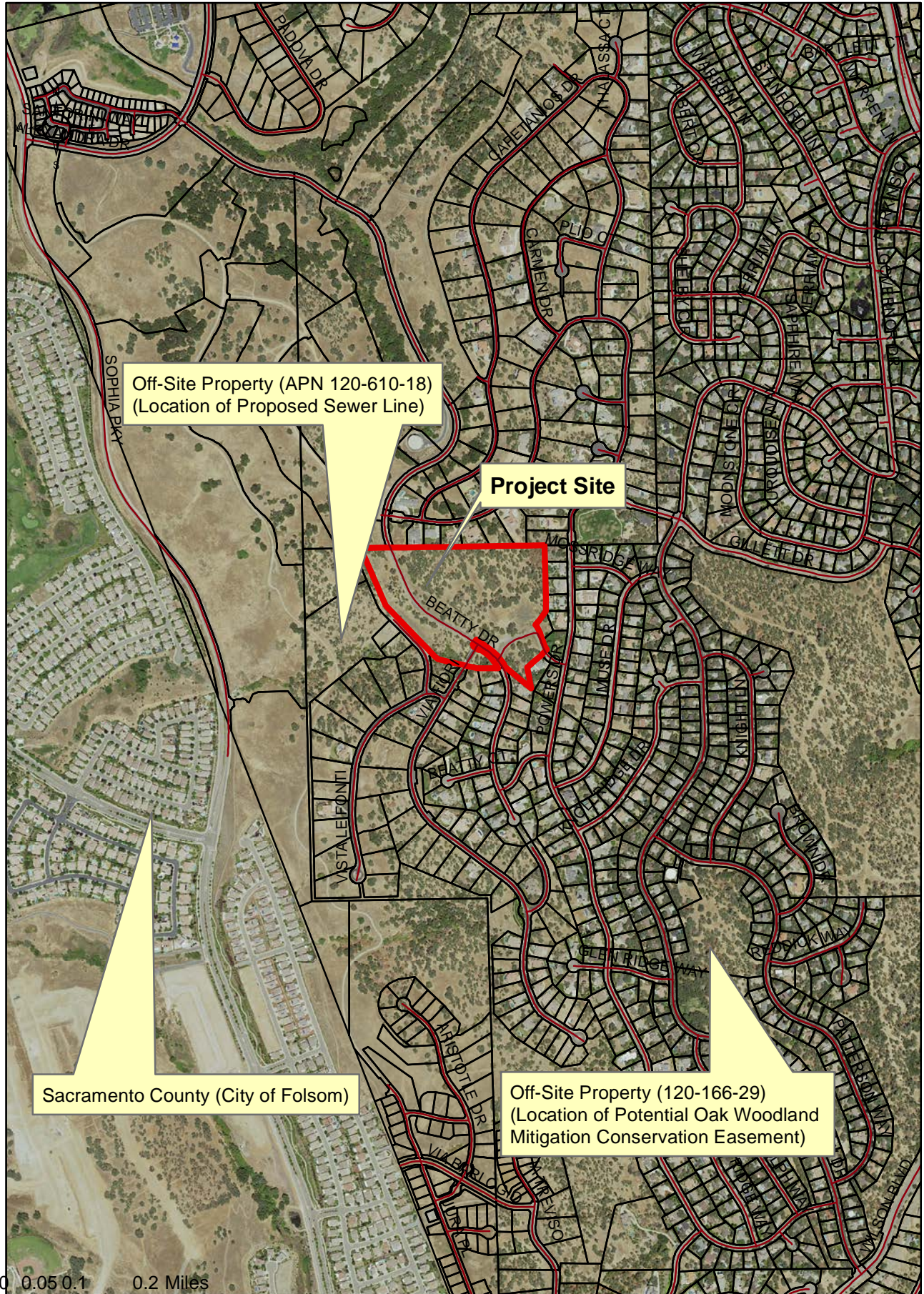

**Map of Off-Site Properties (Aerial)**



# RIDGEVIEW VILLAGE UNIT 9 PHASE 0

## PROPOSED PHASING PLAN

EL DORADO HILLS, CALIFORNIA  
 SCALE: 1"=100' FEBRUARY, 2018

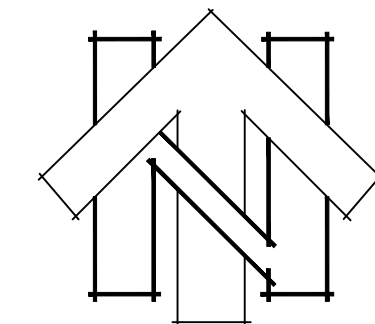

0 30' 60' 120'  
 SCALE: 1" = 60'

### LEGEND:

- SUBDIVISION BOUNDARY
- LOT LINE
- PHASE LINE

PHASE	LOT COUNT
①	23
②	21

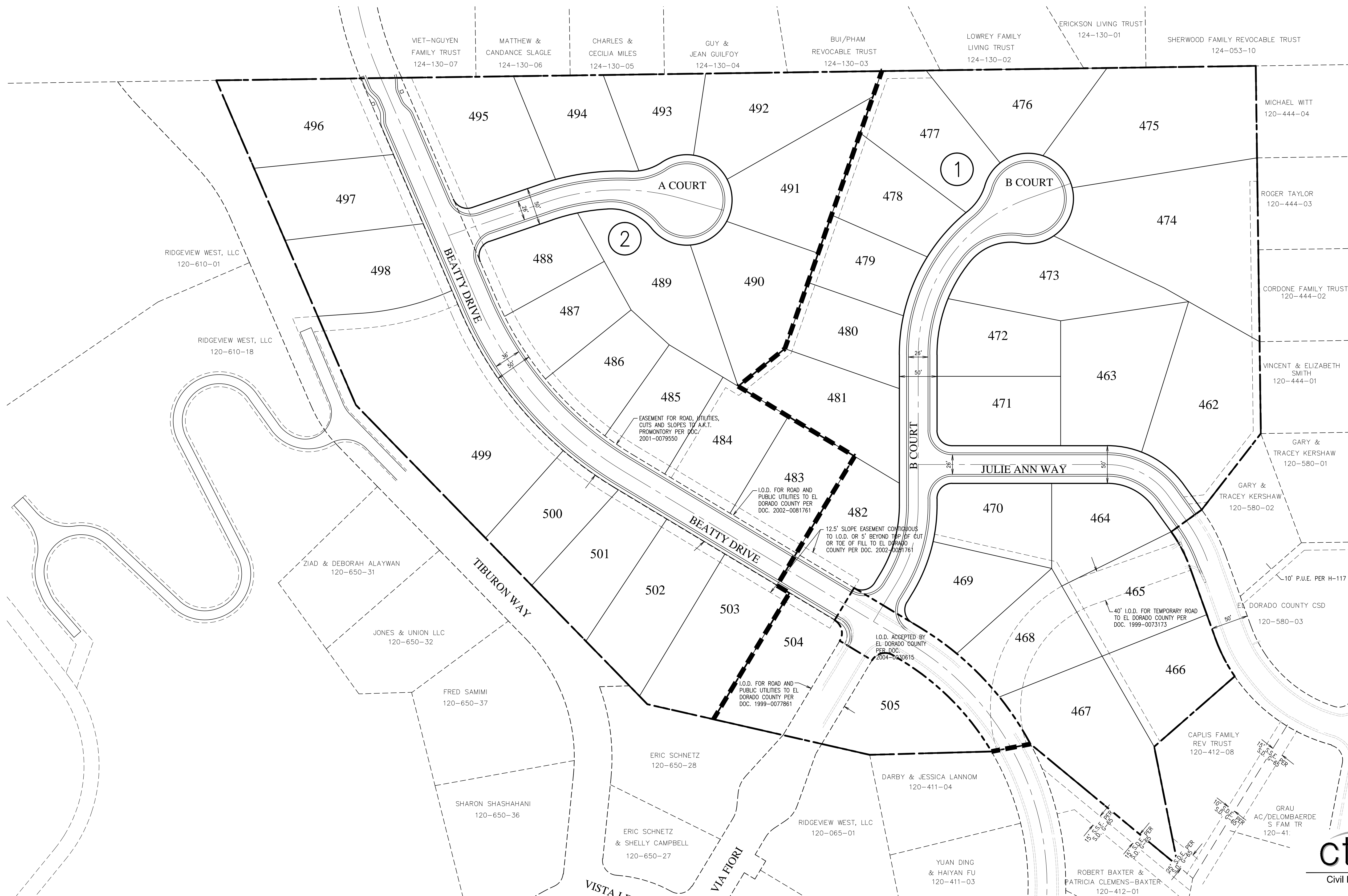

**cta** Engineering & Surveying  
 Civil Engineering ■ Land Surveying ■ Land Planning  
 3233 Monier Circle, Rancho Cordova, CA 95742  
 T (916) 638-5919 ■ F (916) 638-2479 ■ www.ctaes.net



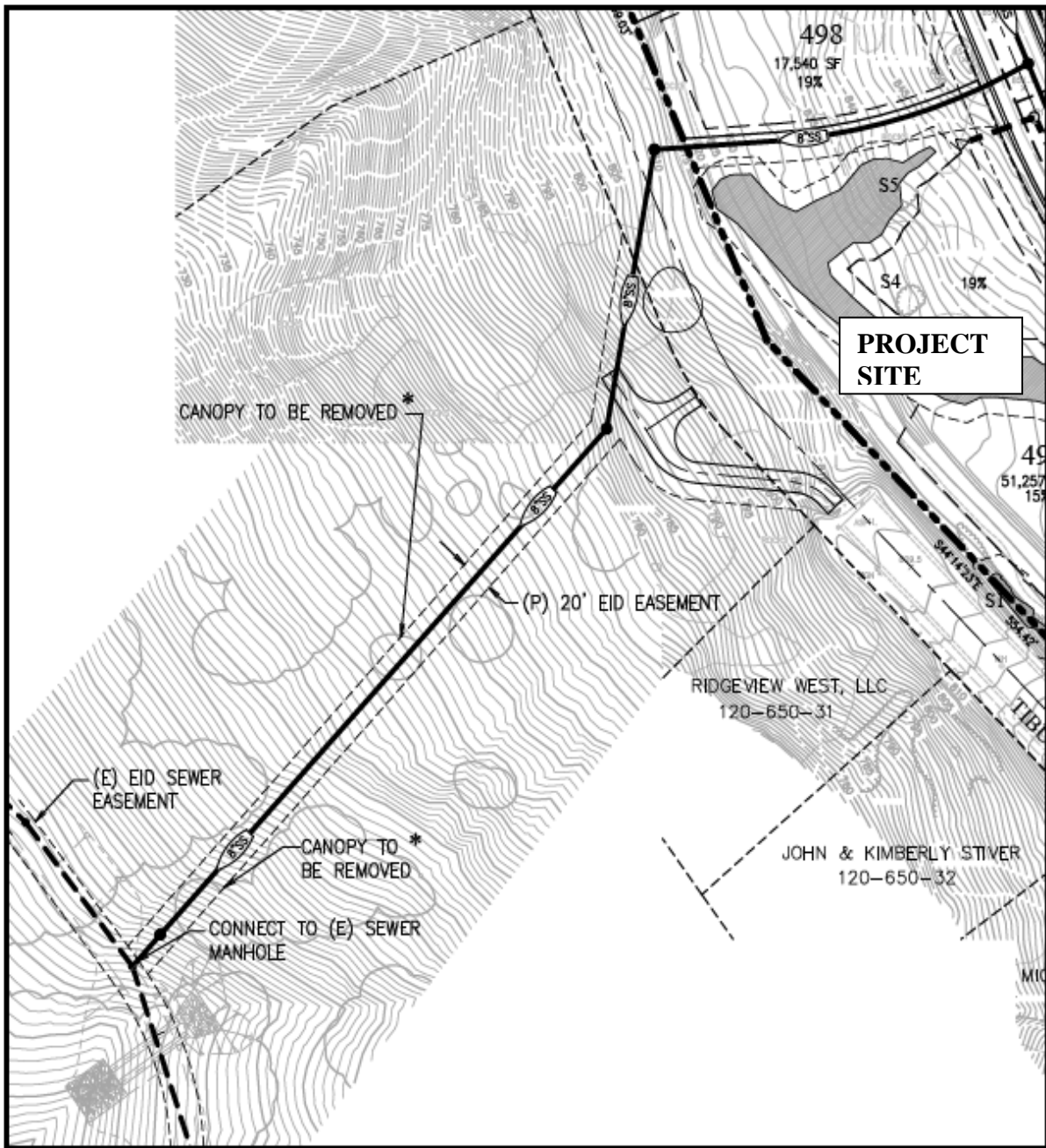

\* INCLUDED INTO REMOVAL CALCULATIONS. SEE TREE PRESERVATION PLAN.

## OFFSITE SEWER EXHIBIT

SCALE: 1"=100'

EXHIBIT I: Approved Off-Site Sewer Line for Ridgeview Village Unit No.9 (TM08-1477)



**FIGURE B-1**  
**RIDGEVIEW VILLAGE UNIT 9**  
**EL DORADO COUNTY, CALIFORNIA**  
 SCALE: 1"=60'  
 JULY 2017



- LEGEND**
- EXISTING SEWER
  - PROPOSED SEWER
  - NODE POINT
  - PROPOSED PIPE DATA
  - BOUNDARY LINE
  - PROPERTY LINE
  - PLUMBED SEWER SERVICE

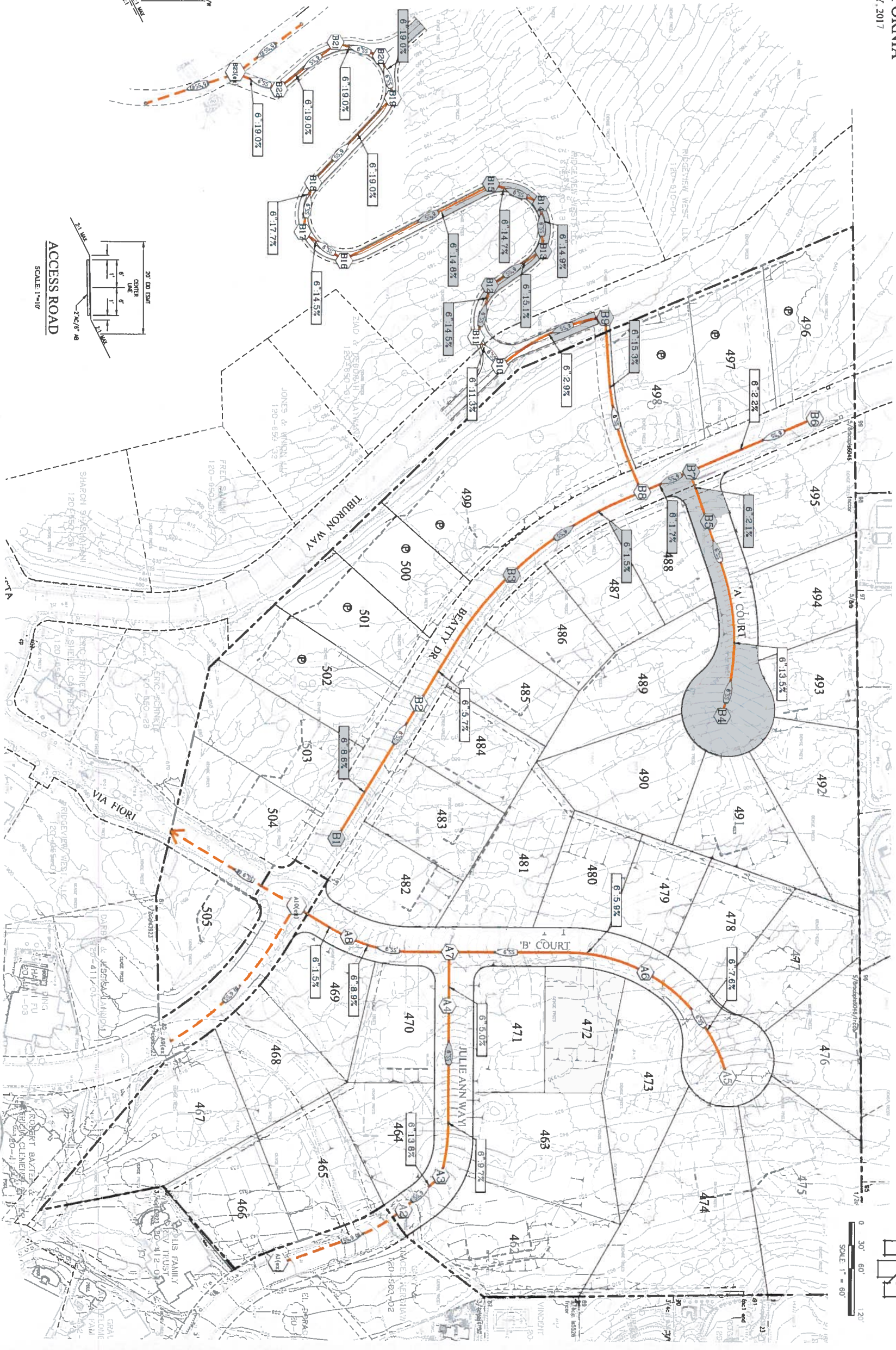
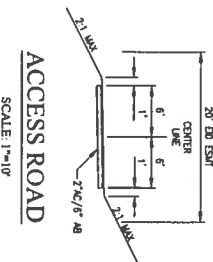
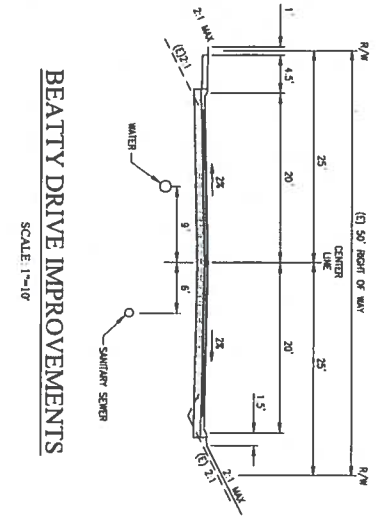
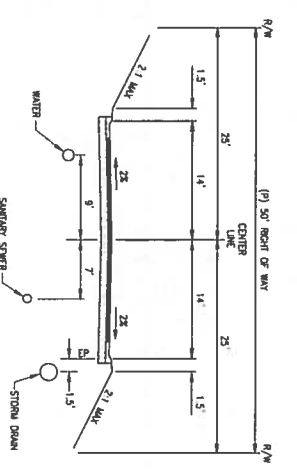
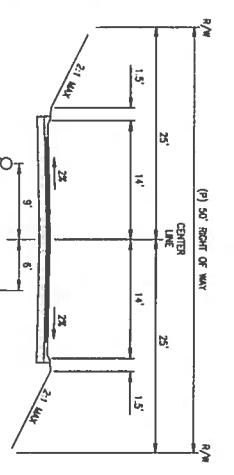

0 30' 60' 120'  
 SCALE: 1" = 60'



# RIDGEVIEW UNIT 9

## OFFSITE SEWER THROUGH VILLADORO HOA LOT B

EL DORADO HILLS, CALIFORNIA

SCALE: 1"=50'

OCTOBER, 2017

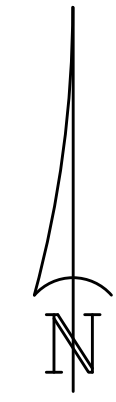

0 25' 50' 100'  
SCALE: 1" = 50'

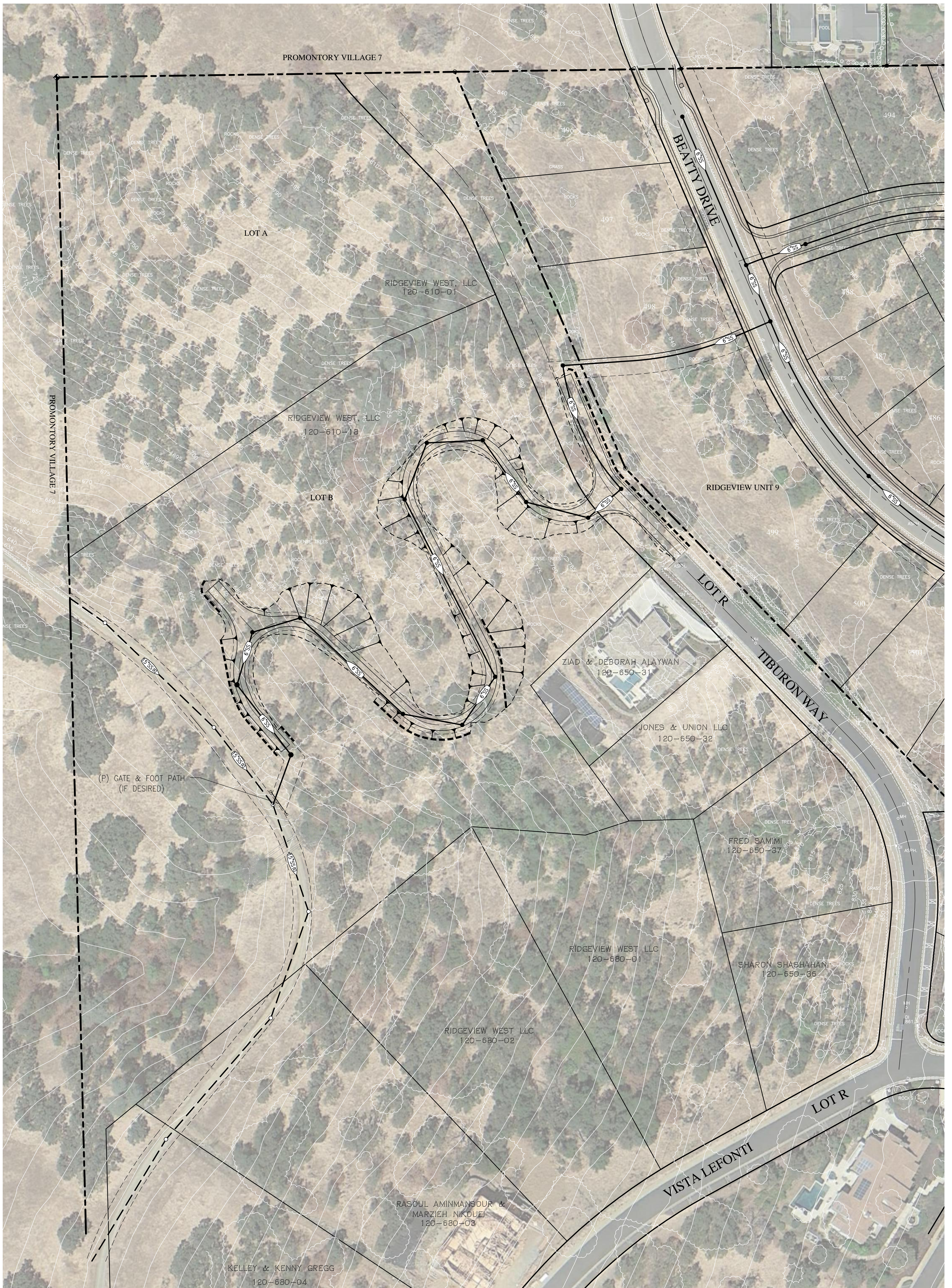

**cta** Engineering & Surveying

Civil Engineering ■ Land Surveying ■ Land Planning  
3233 Monier Circle, Rancho Cordova, CA 95742  
T (916) 638-0919 ■ F (916) 638-2479 ■ www.ctaes.net



## MODIFICATION OF AGREEMENT REGARDING EASEMENTS

Reference is made to the Agreement Regarding Easements entered into on September 9, 2014, by and between the Ridgeview West Owners Association, (hereinafter RW HOA), and Pacific States Development Corporation, (hereinafter PSDC), a copy of said Agreement is attached hereto and incorporated herein by reference.

WHEREAS, the sewer line alignment depicted in Exhibit "C" of the above described Agreement is being modified pursuant to a request by the El Dorado Irrigation District, (hereinafter EID), in order to lessen the slope of its sewer line grade; and

WHEREAS, CTA Engineering and Surveying, the civil engineer for PSDC, has prepared a revised alignment of the sewer line as depicted on Figure B-1; and

WHEREAS, at the October 10, 2017 RW HOA meeting and subsequent discussions between the parties, PSDC has agreed to include certain conditions to the Agreement Regarding Easements at the request of the RW HOA, as more particularly described in 2 below;

NOW THEREFORE, the parties agree as follows:

1. The revised Figure B-1- revised 2017 shall be the new sewer alignment crossing RW HOA property, and shall be substituted to replace the prior alignment in Exhibit "C";
2. Upon the recordation of the Ridgeview Village Unit No. 9 subdivision map, and construction of the improvements for said subdivision the following items requested by RW HOA shall be included and performed:
  - a. The EID easement roadway shall be constructed using decomposed granite with an all weather surface binding agent;



b. Gates at both ends of the easement shall be constructed with access provided to EID, and HOA members only. Said gates shall be six(6) foot high single swing black ornamental iron, with smooth top rails and shall be placed at the locations shown on Figure B-1. Further said gates shall provide for a pedestrian opening for access by HOA members, and further boulders shall be placed on either side of said fences to prevent unwanted access and trespassing. Said gates shall be maintained by a Home Owners Association to be formed for the Ridgeview Village Unit No. 9 subdivision,(the RV9 HOA)

c. The covenants, conditions and restrictions (CC&R's) for Ridgeview Village Unit No. 9, shall contain a provision requiring the placement of black, six (6) foot ornamental iron fencing, with smooth top rails along the rear property line of the lots in Ridgeview Village Unit No. 9 backing up and above Tiburon Way or any future extension of Tiburon Way.

All remaining terms and conditions of the September 9, 2014 Agreement Regarding Easements shall remain the same and in full force and effect.

DATE: 5/9/2018

RIDGEVIEW WEST OWNERS ASSOCIATION (RW HOA)

By Julia R. Wright  
Its Treasurer

DATE: 5-7-2018

PACIFIC STATES DEVELOPMENT CORPORATION

By Gillian J. Fisher  
Its President

# FIGURE B-1

RIDGEVIEW VILLAGE UNIT 9  
EL DORADO COUNTY, CALIFORNIA  
JULY, 2017  
SCALE: 1"=60'

- LEGEND**
- EXISTING SEWER
  - PROPOSED SEWER
  - MANHOLE POINT
  - PROPOSED PIPE DIA.
  - ROUNDERMAN PROPERTY LINE
  - ROUNDING SEWER MANHOLE

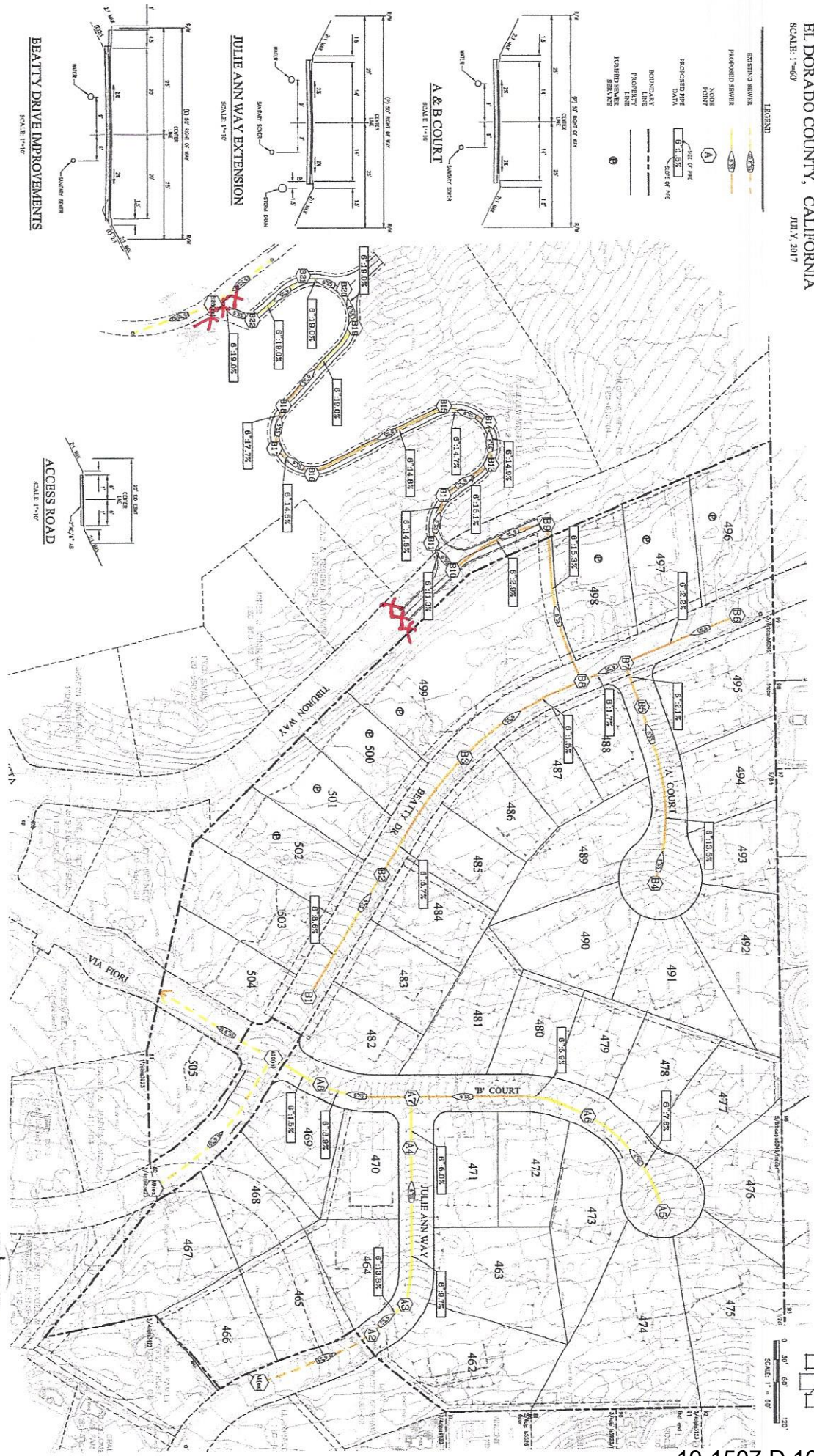

*XXX - location of gates*



**cta** Engineering & Surveying  
Civil Engineering • Land Surveying • Land Planning  
3233 Niles Circle, Reno, California, CA 95742  
916.782.1500 • 916.782.1501 • www.cta-engineering.com



# TREE PRESERVATION PLAN

# RIDGEVIEW VILLAGE UNIT 9

## SECTION 34, T.10 N., R.8 E., M.D.M.

### NOTES

- TOTAL SITE AREA = 22.4 AC  
TOTAL SITE CANOPY = 14,37 AC. (64.4% OF PROJECT SITE)  
TREES EXCLUDED FROM CALCULATION = 0.08 AC  
ALLOWABLE REMOVAL UNDER OPTION "A" = 30% (EXISTING CANOPY) = 4.29 AC  
TOTAL REMOVAL PER PLAN = 4.29 AC  
14.198 AC EXCLUDE DEAD, DISEASED AND NON-OAK CANOPY AREA  
TOTAL HEALTHY OAK CANOPY LOSS = 4.29 AC.  
MITIGATION AREA REQUIRED = 4.29 AC.
- THE PROJECT PROPONENT SHALL COMPLY WITH THE PROVISIONS OF POLICY 7.4.4.4 BY MEETING THE RETENTION REQUIREMENTS AND 1:1 REPLACEMENT RATIO OF OPTION A, PROVIDING ON- OR OFF-SITE MITIGATION AS ESTABLISHED IN GP POLICY 7.4.4.4. AND ITS INTERIM GUIDELINES.
- GRANTING OF ANY REQUIRED EASEMENTS SHALL BE REQUIRED AS A CONDITION OF APPROVAL OF ALL DISCRETIONARY PERMITS FOR WHICH THESE PROVISIONS APPLY, AND SHALL BE COMPLETED PRIOR TO ISSUANCE OF A GRADING OR BUILDING PERMIT, FILING OF A PARCEL OR FINAL MAP, OR OTHERWISE COMMENCING WITH THE PROJECT.
- THE MITIGATION MAY BE PHASED TO REFLECT THE TIMING OF THE TREE CANOPY REMOVAL SUCH AS REMOVAL ASSOCIATED WITH STREET AND INFRASTRUCTURE GRADING AND GRADING ASSOCIATED WITH CONSTRUCTION OF SINGLE FAMILY DWELLINGS AND ACCESSORY STRUCTURES.
- THE PROJECT IMPACTS WILL RESULT IN THE FOLLOWING MITIGATION ALLOCATION:  
OPTION A REMOVAL (ROADS & GRADING)..... 1.28 (BY DEVELOPER)  
OPTION A REMOVAL (LOTS ONLY)..... 3.01 AC (BY LOT OWNER)  
TOTAL REMOVAL..... 4.29 AC
- THE DEVELOPER RESERVES THE RIGHT TO CHANGE THE ALLOCATION ABOVE AS LONG AS OVERALL OAK CANOPY REMOVAL DO NOT EXCEED ALLOWED REMOVAL FOR THE PROJECT UNDER OPTION "A" (4.29 AC).
- CANOPY REMOVAL UNDER OPTION "A" (1:1 RATIO) ALLOWS FOR REMOVAL OF THE CANOPY ON INDIVIDUAL RESIDENTIAL LOTS IN AN AMOUNT SPECIFIED IN THE TABLE BELOW.
- NO CANOPY SHALL BE REMOVED BY INDIVIDUAL LOT OWNERS IN EXCESS OF THAT SPECIFIED IN THE TABLE BELOW UNDER OPTION "A". THE DEVELOPER RESERVE A RIGHT TO CHANGE THAT ALLOCATIONS AS LONG AS OVERALL OAK CANOPY REMOVAL DO NOT EXCEED ALLOWED REMOVAL FOR THE PROJECT UNDER OPTION "A" OF GP POLICY 7.4.4.4.
- THE ARBORIST MAY REQUIRE THE REMOVAL OF ADDITIONAL TREES IF HE WARRANTS THEM TO BE A HAZARD WITHIN OR OUTSIDE OF THE CONSTRUCTION LIMITS AND/OR BUILDING SITES. THESE TREES ARE NOT SUBJECT TO REPLACEMENT STANDARDS PER INTERIM GUIDELINES APPROVED FOR POLICY 7.4.4.4. IF THE ARBORIST FINDS THEM DEAD, DISEASED OR DYING.
- TREE PROTECTION FENCING SHALL BE PLACED AFTER COMPLETION OF TREE REMOVAL OPERATIONS AND PRIOR TO CLEARING AND GRUBBING.
- OPTION B IS NOT AVAILABLE AT THE TIME OF PREPARATION OF THIS MAP. IN AN EVENT PAYMENT OF FEE IN LIEU OF CANOPY REPLACEMENT BECOMES AVAILABLE, THE APPLICANT RESERVES THE RIGHT TO CHANGE HIS MITIGATION OPTION IN COMPLIANCE WITH ADOPTED ZONING ORDINANCE.

COUNTY OF EL DORADO

APRIL 2013

STATE OF CALIFORNIA

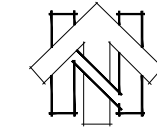

SCALE: 1" = 60'

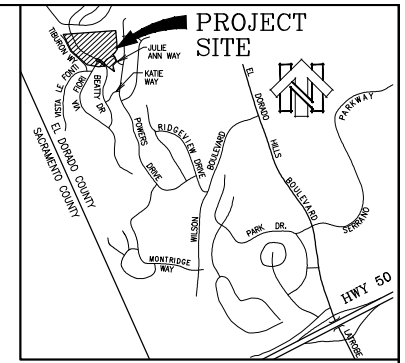

VICINITY MAP  
NOT TO SCALE

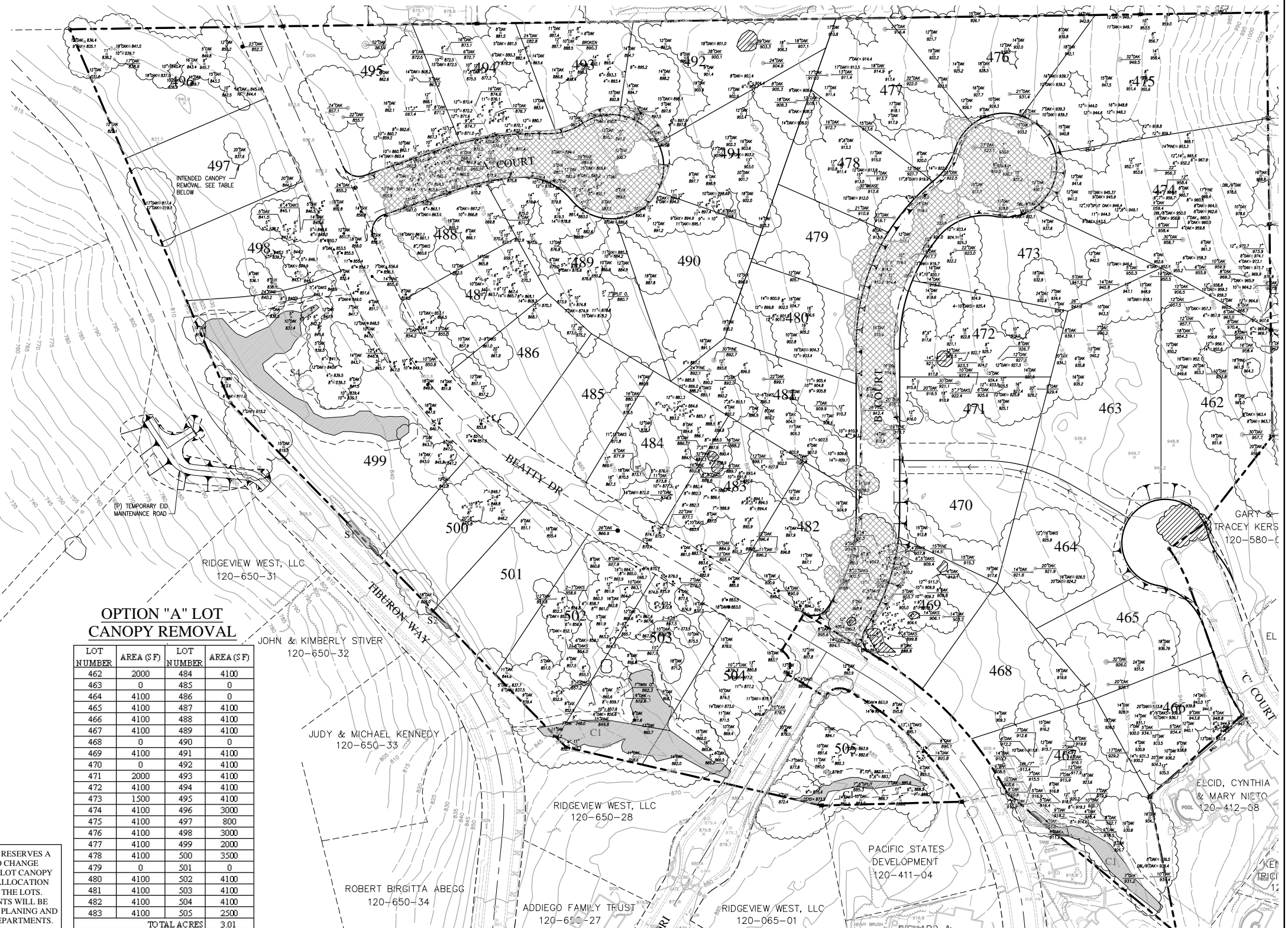

### OAK WOODLAND CONSERVATION EASEMENT

APN: 120-166-29

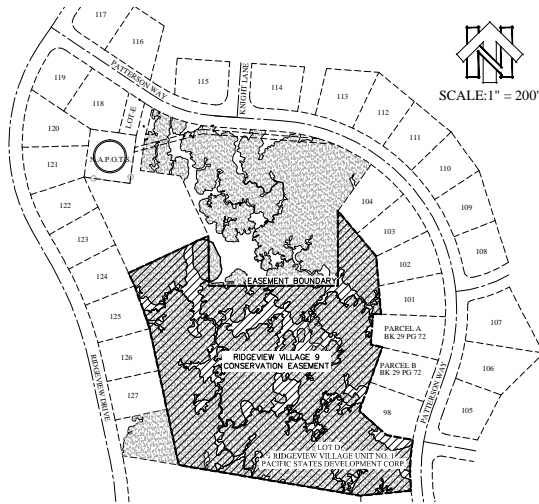

SCALE: 1" = 200'

### OPTION "A" LOT CANOPY REMOVAL

LOT NUMBER	AREA (\$F)	LOT NUMBER	AREA (\$F)
462	2000	484	4100
463	0	485	0
464	4100	486	0
465	4100	487	4100
466	4100	488	4100
467	4100	489	4100
468	0	490	0
469	4100	491	4100
470	0	492	4100
471	2000	493	4100
472	4100	494	4100
473	1500	495	4100
474	4100	496	3000
475	4100	497	800
476	4100	498	3000
477	4100	499	2000
478	4100	500	3500
479	0	501	0
480	4100	502	4100
481	4100	503	4100
482	4100	504	4100
483	4100	505	2500
TOTAL ACRES		3.01	

### NOTES

- OAK WOODLAND CANOPY REMOVED PER OPTION A = 4.29 AC
- CONSERVATION EASEMENT AREA = 5.7 AC
- OAK WOODLAND CANOPY WITHIN EASEMENT AREA = 4.75 AC (AS OF MARCH 2012).
- SURPLUS CANOPY AVAILABLE FOR FUTURE MITIGATION = 0.46 AC

### LEGEND

- TREE CANOPY TO BE REMOVED FOR ROAD INFRASTRUCTURE
- EXISTING WETLANDS
- DAYLIGHT LINE
- RW
- LOT LINE
- PROPERTY LINE
- DEAD/DISEASED & NON-OAK TREES EXCLUDED FROM CANOPY ANALYSES AND MITIGATION

DEVELOPER RESERVES A RIGHT TO CHANGE INDIVIDUAL LOT CANOPY REMOVAL ALLOCATION BETWEEN THE LOTS. AMENDMENTS WILL BE PROVIDED TO PLANING AND BUILDING DEPARTMENTS.

EXHIBIT L

CTA Engineering +Surveying  
3233 Monser Circle  
Rancho Cordova, CA 95742  
(916) 638-0919  
(916) 638-2479 Fax





California Tree and Landscape Consulting, Inc.

*asca*  
AMERICAN SOCIETY of  
CONSULTING ARBORISTS



## Arborist Report

**February 28, 2018**

Pacific States Development  
991 Governor Drive, Suite 103  
El Dorado Hills, CA 95762

Attention: Tom Cassera, CTA Engineering and Surveying  
William J. Fisher, President

**Work location**  
**Ridgeview Village Unit 9**  
**El Dorado Hills, CA 95762**

**Arborist Report for Oak Woodland Resources**

**Prepared by:**  
**Gordon Mann, Consulting Arborist**

**EXHIBIT M**

2018 MAR - 7 PM 4: 55  
RECEIVED  
PLANNING DEPARTMENT



## **Arborist Disclosure Statement**

Arborists are tree specialists who use their education, knowledge, training and experience to examine trees, recommend measures to enhance the beauty and health of trees, and attempt to reduce the risk of living near trees. Clients may choose to accept or disregard the recommendations of the arborist, or to seek additional advice.

Arborists cannot detect every condition that could possibly lead to the structural failure of a tree. Trees are living organisms that fail in ways we do not fully understand. Conditions are often hidden within trees and below ground. Arborists cannot guarantee that a tree will be healthy or safe under all circumstances, or for a specified period of time. Likewise, remedial treatments, like any medicine, cannot be guaranteed.

Treatment, pruning and removal of trees may involve considerations beyond the scope of the arborist's services such as property boundaries, property ownership, site lines, disputes between neighbors, and other issues. Arborists cannot take such considerations into account unless complete and accurate information is disclosed to the arborist. An arborist should then be expected to reasonably rely upon the completeness and accuracy of the information provided.

Trees can be managed, but they cannot be controlled. To live near trees is to accept some degree of risk. The only way to eliminate all risk associated with trees is to eliminate all trees.

### **Assignment**

The subject site is an approximately 22.4 acre open site surrounded by developed homes, and an approximately 1.2 acre offsite sanitary sewer/access road. The site is divided into two parts, the home development, and the access road for the offsite sewer connection. The client contacted our office and requested we provide the information required to satisfy the County of El Dorado's Oak Woodland Resources, determining the oak woodland area, identifying all trees in the woodland area 24 inches in diameter and greater, all Heritage Trees 36 inches in diameter and greater, and any individual oak trees 6 inches and greater located outside of the woodland designation for mitigation for tree removal based on the County ORMP Oak Resources requirements and Ordinance No. 5061. This report is the result of onsite inspections performed on December 7, 2017, January 10, 14, 16, and 18, 2018, and the use of aerial imagery. The proposed Oak Conservation Easement was re-inspected on February 28, 2018.

This report is based on the current proposal under the new County ORMP ordinance and mitigation requirements. Nothing significantly has changed with the site, and the proposed mitigation is intended to meet the County Requirements for Oak Resource Conservation.

### **Assignment limits**

All the trees were observed while standing on the ground. Data collected is limited to a visual ground inspection. The aerial image was provided by CTA Engineering and Surveying. Ground inspections and measurements were used to insure the accuracy of the inspection data.



### **Current Existing Tree Status (general)**

The site is northeast orientation above Beatty Drive, and a slight slope facing southwest for the home sites, and a steeper slope below Beatty Drive past Tiburon Way, and facing southwest for the sewer connection. The development is required to comply with the El Dorado County ORMP Oak Resources requirements and Ordinance No. 5061.

The site is mostly Blue Oaks, *Quercus douglasii*, and some Interior Live Oak, *Quercus wislizenii*. There were a total of 39 trees found to be 24 inches in diameter and greater on both areas of the project. There were 27 trees found to be 24 inches diameter and greater on the housing portion of the project, with 3 trees found to be Heritage Trees, 36 inches in diameter and greater. Of the 3 Heritage Trees, 2 were found to be in Poor condition and would not require mitigation, and 1 is dead and would not require mitigation.

There were 12 trees 24 inches and greater found in the sewer connection portion of the project, and no trees 36 inches in diameter or greater.

The entire 22.4 acre housing portion of the project area, less existing asphalt streets Via Fiori, 0.16 acre, Beatty, 1.11 acre, and the Connector, 0.47 acre, equaling 1.74 acres of roads. The area found to be Oak Woodland is 20.66 acres. There are 3.64 acres of undisturbed area proposed in Phase 1, and 3.77 acres of undisturbed area proposed in Phase 2 for a total of 7.41 acres of undisturbed area. The total Oak woodland being impacted is determined to be 20.66 acres. Subtracting 7.41 undisturbed acres equals 13.25 acres of impacted oak woodland required for mitigation.

The mitigation ratio is determined by the amount of existing Oak Woodland canopy being impacted. A total of 13.25 acres of the 20.66 acres equals 64% of the Oak Woodland being impacted. The mitigation ratio for El Dorado County ORMP is:

Percent of Oak Woodland Impact	Oak Woodland Mitigation Ratio
0-50%	1:1
50.1 – 75%	1.5:1
75.1-100%	2:1

The proposed oak woodland impact falls into the impact range of 50.1 - 75%. The percent woodland removal/impact requires a 1.5:1 mitigation ratio. 1.5 ratio X 13.25 impacted acres = 19.875 total acres required for Oak Mitigation.

The client is proposing a 9-acre offsite conservation easement. The remaining 10.875 acres will require mitigation at the cost of \$8,285.00 per acre, for a total mitigation fee of \$90,099.38. If the Oak Conservation Easement is not used, the total mitigation fee would be \$164,664.40.

The final mitigation calculation is the impact to Heritage trees. Three trees 36 inches and greater are considered Heritage Trees and were found in the housing portion of the project. One Heritage Tree, #917, is 39 inches diameter, and in poor condition. The tree is growing in an area outside of a housing lot and not proposed for disturbance. It would not require mitigation if removed. Another Heritage Tree, #909, is 37 inches in diameter, and in poor condition. The tree is growing in an area



outside of a housing lot and not proposed for disturbance. It would not require mitigation if removed. Both trees #909 and #917 could be pruned with reducing the size and leverage of branches, and removal of decayed branches, and managed as a smaller tree. A third Heritage Tree, #164 using the old tag number is dead. Tree #164 is dead and should be removed or reduced and managed for a habitat tree. Development is proposed in this area. Mitigation not required for this tree.

The proposed 9-acre Oak Conservation Easement is a sloped parcel adjacent to the rear yards of single family homes and Ridgeview Park. The site is an Oak Woodland with a mix of oak species, buckeye, and pine. During the recent visit, the amount of natural oak tree regeneration was limited.

### **Technical Recommendations**

It is recommended that all tree care follow specifications written in accordance with ANSI A-300 standards. Pruning of the trees should be performed in the outer edge of the canopy to reduce leverage and end weights and allow the center of the canopies to grow and fill in with foliage. It is also recommended that when root pruning, the smallest size roots as possible be pruned, cuts be performed with handsaws, loppers, or chainsaws appropriate for the size of the root being cut. The roots should be exposed by excavating prior to cutting. Roots should be pruned prior to root removal within the tree protection area to limit the damage and tearing of roots back towards the tree. Root pruning should be overseen by a qualified arborist.

Tree planting should follow the specifications included in Appendix A.

### **General Tree Care and Maintenance**

The appendix information is given so that an onsite landscape manager can properly take care of the retained trees, and newly planted trees. Established native oak trees do not like to have the base of the trunk or their roots and the surrounding soil disturbed or tampered with. Applying or having unintentional landscape water in the root zone can cause catastrophic and negative affects to most species of native oak trees. Newly planted oak trees do need their root balls watered until established and then may need supplemental watering during extended periods of dry or hot weather. It is, therefore, recommended that the landscape be designed using drought tolerant plants that will require little to no watering after establishment. Irrigation should be delivered using an on-surface drip type system that does not require trenching around the oak trees to install. The plants should be spaced at least 6 feet away from the trunk of native oak trees, and the drainage from irrigation should be managed so water does not flow to the trunks of the oak trees. Trees that are growing in high use areas should be inspected by a qualified arborist for tree risk on a routine basis, the frequency depending on site use and tree condition.

### **Observations**

The site was inspected on December 7, 2017, January 10, 14, 16, and 18, 2018. All trees were inspected for diameter, and those trees that were 24 inches diameter or greater were measured with a diameter tape, assessed for condition, the number of stems present, and notes explaining the tree condition were recorded. A total of 39 trees were found to be 24 inches diameter or greater, and 3 of those trees were found to be 36 inches in diameter or greater and considered Heritage Trees. The data is provided on the attached Ridgeview Village Unit 9 Oak Woodland Tree List.



The tree condition rating is a combination of vigor, structure, trunk, branches, trunk flare, live tissue, and defects and decay or pests. It is described in % and range term. The rating scale is:

<u>Range</u>	<u># Rating</u>	<u>Description</u>
Excellent	81-100	Found to have none to few defects or decay, and high vigor
Good	61-80	Found to have few defects or decay, and above average vigor
Fair	41-60	Found to have mitigatable defects, limited decay, and average vigor
Poor	21-40	Found to have significant defects, decay, and lower vigor
Very poor	120	Found to have significant defects, decay, and low declining vigor
Dead	0	Found to be dead

Plus and minus symbols are included in the rating range to show the position of the % rating in the range.

The oak canopy area was calculated by CTA Engineering and Surveying using aerial imagery calculating the area of the site considered Oak Woodland. The field inspection confirmed the location of the canopy as shown on the aerial image.

DBH is the industry standard for measuring trunk diameter. For trees with straight trunks and normal taper, the measurement is taken at 4.5 feet above grade. When a swollen area, flare from branching, multiple stems, or other abnormal growth is present, the measurement is taken at the most appropriate location for determining the reasonable trunk diameter, and the height of the measurement is listed. The initial measurements were taken with a Biltmore Stick. For all trees close to 24 inches diameter or greater, a second more accurate measurement was taken with a diameter tape.

The proposed development is 22.4 acres, less the 1.74 acres of asphalt roads. The total Oak Woodland was found to be 20.66 acres. There are 3.64 acres of undisturbed area proposed in Phase 1, and 3.77 acres of undisturbed area proposed in Phase 2 for a total of 7.41 acres of undisturbed area. The total Oak woodland being impacted is determined to be 20.66 acres. Subtracting 7.41 undisturbed acres equals 13.25 acres of impacted oak woodland required for mitigation. The canopy shown on the aerial image was confirmed during the field visits to be an accurate representation.

The proposed 9 acre Oak Conservation Easement was re-visited on Wednesday, February 28, 2018. The site is an open space area behind single-family home rear yards, and adjacent to Ridgeview Park. There is one entry into the park from Patterson Way. There were Valley Oak, Interior Live Oak and Blue Oak on the site, along with California Buckeye and Gray Pine. The site has experienced some previous disturbance as there is a 10' water easement and a road leading to a El dorado Hills County Water District water storage tank.

**Other testing or examination:**

No additional testing or examination was requested at the time of the inspection or found necessary.



**Discussion:**

The site is an oak woodland area with some existing asphalt streets. The site is bordered on the upper 3 sides by existing home developments. The fourth lower side is the proposed sewer connection area on a steep downward slope below the proposed homes.

The Oak Woodland required for mitigation is 13.25 acres with a mitigation ratio of 1.5. The total Oak Woodland acreage required for mitigation is 19.875 acres. A 9-acre Oak Conservation Easement is proposed towards the required mitigation, and a remaining 10.875 acres is required for mitigation. At a fee rate of \$8,285.00 per acres, the total mitigation fee will be \$90,099.38. If the 9-acre Oak Conservation Easement is not provided, the total mitigation fee for 19.875 acres will be \$164,664.40.

The mitigation proposed will meet the required mitigation based on the El Dorado County ORMP Oak Resources requirements and Ordinance No. 5061.

The proposed 9-acre Oak Conservation Easement had limited oak regeneration, and would benefit from some oak planting in a sequential manner, adding a small amount of new trees over the next six years, by planting 25 to 50 trees per year every other year for three cycles.

**Conclusion:**

There are 13.25 of the 20.66 acres Oak Woodland area being impacted. The percent woodland removal/impact requires a 1.5:1 mitigation ratio. The 1.5 ratio X 13.25 impacted acres = 19.875 total acres required for Oak Mitigation.

The client is proposing a 9-acre offsite conservation easement. The remaining 10.875 acres will require mitigation at the cost of \$8,285.00 per acre, for a total mitigation fee of \$90,099.38.

There were no Heritage Trees in fair or good condition impacted by the proposed development, and the total calculated mitigation fee after the 9 acres Oak Conservation Easement is \$90,099.38. The mitigation proposed will meet the required mitigation based on the El Dorado County ORMP Oak Resources requirements and Ordinance No. 5061.

Please contact Gordon Mann, of California Tree and Landscape Consulting, Inc., if there are any questions about this report.

Disclaimer: Gordon Mann, has analyzed the situation, applied the proper method(s) utilized within the profession, and performed a reasonableness test to support the project tree related decisions. I, nor the employees or subcontractors of California Tree and Landscape Consulting, Inc., may be held liable for the misuse or misinterpretation of this report. As the author of this report, I do hereby certify that all the statements of fact in this report are true, complete, and correct to the best of my knowledge and belief, and that they are made in good faith.



Respectfully submitted,



Gordon Mann  
ASCA Registered Consulting Arborist #480  
ISA Certified Arborist WE- 0151AM  
ISA TRAQ Qualified Tree Risk Assessor  
California Tree and Landscape Consulting, Inc.  
[Gordon@caltlc.com](mailto:Gordon@caltlc.com)  
650-740-3461

Attachments:

- Appendix A Tree Planting Specifications
- Appendix B Nursery Stock and Tree Planting
- Appendix C Tree Protection
- Appendix D Avoiding Damage During Construction
- Resume for Gordon Mann
- Ridgeview Village Unit 9 Oak Woodland Tree List
- Ridgeview Unit 9 ORMP Analysis Image



Images



Google Earth

feet

1000

Heritage Trees # 164, 909, & 917



Appendix A  
Tree Planting Specifications

Trees shall be free of major injury such as scrapes that remove greater than 20% of the bark circumference, a broken central leader, or constrictions from staking or support. The graft, if present, shall be consistent for the production of the cultivar or species. The trunk flare shall be at grade, not buried by soil, and adventitious roots shall not be growing from above the trunk flare.

The tree shall not be root bound in the container, and the trunk diameter relative to the container sizes, within the limits of American National Standards Institute (ANSI) Z-60 Nursery Standards.

Prior to acceptance, upon delivery, trees may be pulled from the container, so the rootball can be inspected for compliance with the specifications. An agreed upon maximum percent of trees may be checked for compliance. The nursery should provide post delivery care specifications to keep the trees in optimum condition until planting.

Tree Planting

**1.0 INSPECT THE TREE**

- 1.1 Carefully remove the soil at the top of the container to locate the trunk flare. Check for girdling roots and damage to the root system and lower trunk.
- 1.2 Until a relationship is established with the supplying nursery, randomly select an acceptable sample for the delivery. Inspect the root system by taking the rootball out of the container, and remove all the soil from the root system. Inspect the inner roots to verify that the roots were properly pruned when moved from the initial container to the next larger size. Keep the root system moist during the check. If the roots were properly pruned during container transfer, and the roots have been kept moist, the tree can be planted as a bare root tree.
- 1.3 If the trees are acceptable, each tree shall be removed from the container prior to digging the hole, and the depth of the rootball from the trunk flare to the bottom of the rootball shall be measured. This measurement, less 1" is the depth the pedestal in the center of the planting hole shall be excavated to.

**2.0 DIG THE HOLE**

- 2.1 Shave and discard grass and weeds from the planting site.
- 2.2 The hole should be a minimum 3 times the diameter of the container diameter.
  - 2.2.1 Square containers shall be dug with a circular hole 3 times the container measurement.
- 2.3 Dig the hole, leaving an undisturbed pedestal in the center that the root ball will be set on.
- 2.4 The pedestal shall be excavated to the depth measurement determined above

**3.0 ROOT BALL PREPARATION**

- 3.1 Loosen and straighten outside and bottom roots prior to placing the rootball on the pedestal. The trunk flare (the point where the trunk meets the roots) should be 1" above ground level.
- 3.2 Winding and girdling roots shall be pruned to either the point they are perpendicular to the root ball, or a point where they can be straightened and placed perpendicular to the rootball.
- 3.3 Keep the roots moist during this process so they do not dry out.

**4.0 BACKFILL**

- 4.1 Hold the tree so the trunk and central leader are in a straight upright position.
- 4.2 Backfill soil with the soil you removed around the base of the pedestal and rootball no higher than 2/3, so the tree stands in the upright position
- 4.3 Tamp the soil to remove air gaps, or fill with water and allow soil to settle and drain. Continue to fill the entire hole with existing soil in layers and tamping, up to finished grade. Backfill soil shall not be placed on top of the rootball.
- 4.4 Build a berm at the outside edge of the rootball. The berm shall be a minimum 3 inches high and wide.
- 4.5 Cover the remainder of the backfill soil outside the berm with a set level of mulch (2 to 4 inches deep).



## **5.0 STAKING**

- 5.1 Remove the nursery stake (the thin stake tied to the trunk) that is secured to the tree.
- 5.2 Install the appropriate number of stakes – for example, two stakes on the windward and leeward side of the tree, set at least 2 feet into the native soil outside the rootball.
- 5.2.1 If the area is exceptionally windy, high traffic, or when specified, install 3 or 4 stakes spaced evenly around the circumference, outside the rootball.
- 5.3 One tie per stake shall be placed at the lowest point on the trunk where the tree crown stands upright. Ties shall be placed using a “figure 8” crossing pattern wrapped around the trunk and firmly tied or attached to the stake.
- 5.3.1 Ties shall be loose enough so the tree crown moves up to 3 times the trunk diameter in the wind, and taut enough that the trunk does not rub the stakes during movement.
- 5.4 The stakes shall be cut off above the tie point so branches do not rub the stake above the tie point.
- 5.5 Check the stakes and ties periodically, removing them when the tree is able to stand on its own.
- 5.6 If a leader that should be vertical is drooping, the leader may be temporarily straightened using a bamboo or small diameter wood splint approximately 25% longer than the drooping section of stem, tied to the stem at the top and bottom of the splint to hold the stem vertical. The splint shall be removed prior to girdling or constricting the stem, and may be re-installed as necessary.

## **6.0 MULCH**

- 6.1 Apply a set depth (2 to 4 inches) of wood chips or other organic mulch over the planting hole excavated soil.
- 6.2 Mulch may be placed inside the berm and shall be kept at least 4” away from the trunk flare.
- 6.3 The soil area of the planting hole shall be kept clear of grass and landscape plantings.

## **7.0 WATER/IRRIGATION**

- 7.1 Apply water using a low pressure application, i.e.: trickle from a hose, soaker hose, or bubbler.
- 7.2 Use low water volume to apply the water. Add water long enough to saturate the rootball and planting area.
- 7.2.1 Lawn sprinklers shall not be considered an acceptable method of applying irrigation to newly planted trees.
- 7.3 The initial watering frequency shall be checked by monitoring the soil moisture. Based on the temperature and humidity, learn how long the soil retains the moisture.
- 7.4 After the soil is below field capacity, and before it dries out, repeat the watering process, every so determined days.
- 7.4.1 As the weather and seasons change, the irrigation frequency may change. This will be evaluated by checking soil moisture following water application.
- 7.4.1.1 For example: you may learn irrigation should be applied twice a week during the fall, except in cool or rainy weather. Irrigation may need to be applied every two days during hot dry summer periods.
- 7.5 Irrigation shall be continued for the first three years after planting.
- 7.5.1 Avoiding drying out the rootball and adjacent soil is critical for tree growth and establishment.

## **8.0 PROTECT THE TRUNK**

- 8.1 Avoid damage from mowers and string trimmers to the tender bark of the young tree.
- 8.2 Maintain a clear area free of vegetation around the trunk in the berm or basin area.
- 8.3 Keep the set depth of mulch (2 to 4 inches) coverage of the area around the tree.
- 8.4 Retain temporary low branches along the trunk to shade and feed the trunk.

## **9.0 PRUNING NEWLY PLANTED TREES**

- 9.1 Broken and dead branches shall be pruned.
- 9.2 A central leader shall be identified and retained if present. If co-dominant leaders are present, they shall be pruned to be shorter than the central leader by 20%.
- 9.3 All low temporary branches on the lower trunk shall be retained, and if needed shortened for clearance.



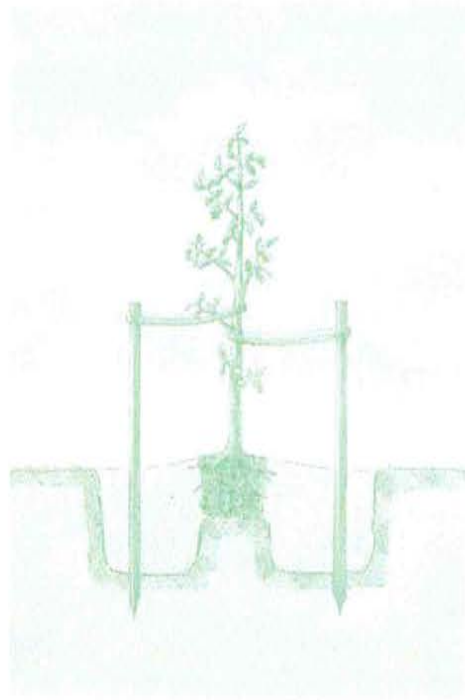

Detail for #1, #5 and #15 container planting stock

#### 10. FUTURE CARE

10.1 During subsequent years, the berm should be enlarged or removed to in order to provide water to the increasing root growth. The watering area should target new root growth and projected root growth.

10.2 Pruning should retain a dominant central leader; and retain low temporary branches until trunk bark hardens or remove before branch diameter becomes too large.

### Appendix B

#### Nursery Stock and Tree Planting

##### Nursery Stock purchase

Trees purchased for the subject project shall be the Genus, species, and cultivar specified in the purchase documents. Trees shall be grown to be free of bound root systems caused by winding roots or kinked roots from a previous smaller container. As trees are moved to larger containers, circling roots shall be either pruned to a point where they can grow straight, straightened in the new container, or removed. Kinked roots shall be pruned to a point where they will grow straight outward or downward.

The trunk and branches shall be of a structure where a central leader is defined, or the central leader can be easily selected. The competing leaders have a smaller diameter, and can be pruned shorter.



## Appendix C

### Tree Protection

The edge of the tree canopy outside of the construction area shall be fenced off with construction fencing, either temporary orange fence or chain link fence. The fence shall be placed as far from the trees as possible, targeting outside the dripline. If the fence cannot be placed outside of the dripline, the project arborist shall determine if the distance is acceptable or some other soil protection is necessary. A certified arborist must approve the placement of the tree fence. The fence will be marked with weather appropriate signage clearly stating the area as "Protected! Do not enter! Tree preservation zone." Sign(s) will be placed on every face or direction of fence line.

No storage of supplies or materials, parking, or other construction activity shall occur within the fenced area. If a construction activity is required within the construction area, specific specifications and mitigation shall be written to cover the work, and the fencing may be entered during the necessary construction activity, then the fencing shall be replaced after the activity is completed for the day.

The construction protection shall remain in place until the project is completed, including landscape activities. Landscape activities shall have specifications that protect the trees during the landscape activities.

Any bare soil around protected trees should be covered with a 4-inch layer of mulch consisting of ground-up tree parts.

If the protected trees appear to show signs of yellowing leaves, dead leaves, or other abnormal appearance, contact the project arborist for inspection and mitigation.

### Long Term Landscape Maintenance Plan and Specifications

#### General

This plan and specifications are intended to promote the optimum landscape growth and lifespan. Individual tree planting in specific sites in the parking lot are intended to provide a large shade canopy over time covering 50% or greater of the parking lot. The border and natural screening plantings are overplanted and intended to fill the space initially, and have the weaker trees removed over time, to create the space and site resources necessary for the remaining trees. Trees initially will be planted on approximate 10 foot centers, with the long term spacing to be approximately 20 foot centers. As trees are thinned, they may be transplanted or removed, as best suited to the remaining trees on the site.

These trees shall be pruned to establish a central leader, to provide the best structure by managing size relationships between parent and subordinate trunk and branches, and to encourage growth into a large shade canopy. These trees shall not be topped or rounded over. Trees may have competing leaders headed back to promote the strong central leader necessary to eliminate co-dominant stems and weak branching.

#### Design Intent

The trees planted around the perimeter and alongside the sidewalk or street are intended to replicate natural areas and to screen the project and adjacent properties. The native oaks shall be more tightly spaced at planting and thinned over time to promote the growth of the final or climax trees on the site. The thinning for spacing shall be performed as the trees get larger and their crowns begin to overlap. When the desired tree crowns are being impacted by an adjacent tree, the adjacent tree should either be pruned or removed, to provide the optimum screening while enhancing the desired tree growth. Pruning shall retain a dominant central leader and for decurrent tree structures, remove competing leaders, and maintain the appropriate size relationships between parent and subordinate trunk and branches.

#### Pruning Small Trees

Branches are to be pruned by either reduction, thinning, or raising cuts to achieve the appropriate clearance over the area. The smallest diameter branches should be removed, working from the branch tips towards the center, removing none to minimal interior foliage inside the final outward branch cut. Trees shall be cleaned to remove dead branches, weakly attached branches, and branches where significant damage has occurred by rubbing, animals, insects, or critical disease. All pruning cuts shall be made in accordance with American National Standards Institute (ANSI) A300 Part 1 Pruning Standards and International Society of Arboriculture (ISA) Best Management Practices for Pruning.



On trees up to six inches in diameter, all dead branches greater than one-half inch diameter shall be removed. All weakly attached branches and potential co-dominant branches shall either be reduced by at least 20% or be removed, as most appropriate for the long term structure of the tree. The weakest or most damaged branch of a pair or group of rubbing branches shall be shortened to avoid rubbing, or removed. All temporary branches along the trunk should be retained and shortened to obtain necessary clearance. When either temporary branches exceed one-inch diameter, or the trunk forms mature bark, the temporary branches should be removed.

Stakes shall be installed as necessary to support a straight growing tree, and reduce crooked growth caused by high wind. The trunk shall be supported at the lowest point to keep the crown supported straight, and the portions of the stake above the tie point cut off to avoid rubbing branches. After the tree becomes firmly rooted, and the stake is no longer necessary to support the tree, the stakes shall be removed.

Depending on the location and site needs, clearance should be performed by pruning the smallest branches inward from the branch tips until the permanent branches are in place. Clearance minimums should be set, for example: 7.5' over sidewalks, 10 feet over parking spaces, and 14.5 feet over truck traffic streets. Clearance pruning shall be carefully performed until the permanent branches are identified. Up to 25% of the total foliage on any tree should be the maximum removed during any planned pruning cycle. Follow-up pruning for structure or clearance on young trees can be performed at any time if pruning small amounts of foliage (up to 10%) and retaining the central leader and branch size relationships.

#### Pruning Large Trees

Branches are to be pruned by either reduction, thinning, or raising cuts to achieve the appropriate clearance over the area. The smallest diameter branches should be removed, working from the branch tips towards the center, removing none to minimal interior foliage inside the final outward branch cut. Trees shall be cleaned to remove dead branches, weakly attached branches, and branches where significant damage has occurred by rubbing, animals, insects, or critical disease. All pruning cuts shall be made in accordance with American National Standards Institute (ANSI) A300 Part 1 Pruning Standards and International Society of Arboriculture (ISA) Best Management Practices for Pruning.

On trees larger than six inches in diameter, all dead branches greater than one-inch diameter shall be removed. Long heavy branches that are either growing flat or bending down shall have approximately 15% of the end weight reduced, accomplished by a combination of pruning the downward growing branches, shortening long tips, and thinning endweights. If any structural issues are observed by the climber working in the tree, they shall notify the property manager immediately to discuss the tree's needs.

Depending on the location and site needs, clearance should be performed by pruning the smallest branches inward from the branch tips until the permanent branches are in place. Clearance minimums should be set, for example: 7.5' over sidewalks, 10 feet over parking spaces, and 14.5 feet over truck traffic streets. Clearance pruning shall be carefully performed until the permanent branches are identified. Up to 25% of the total foliage on any tree should be the maximum removed during any planned pruning cycle.

Any special site issues for utility clearance or conflicts with other objects shall be managed by early pruning to direct growth away from the target lines, overhead lights, flags, or buildings.

#### Thinning of Dense Planting

Many landscape plantings and natural landscape areas are over-planted by installing a greater number of plants at closer spacing than optimum for the full-sized plants. Over time, plants will grow into each other, the crowns will conflict, and the spacing will need to be corrected. Correct spacing is obtained by removing the least desirable plants to meet the final spacing target, within reasonable tolerances.

If conflicting plants are all healthy, it won't matter which plants are removed to achieve the spacing distances. Spaced thinning should be performed before the foliar crowns are intertwined or overlapping. The thinning may be performed over two or three cycles as the trees grow over time, depending on the density and desired final spacing.

The trees initially will be planted on approximate 10 foot centers, with the long term spacing to be approximately 20 foot centers. The healthiest and best specimens should be retained on site. As trees are thinned, they may be transplanted or removed, as best suits the remaining trees on the site.



## Appendix D

### Avoiding Tree Damage During Construction

#### *Information from the ISA*

As cities and suburbs expand, wooded lands are being developed into commercial and residential sites. Homes are constructed in the midst of trees to take advantage of the aesthetic and environmental value of the wooded lots. Wooded properties can be worth as much as 20 percent more than those without trees, and people value the opportunity to live among trees.

Unfortunately, the processes involved with construction can be deadly to nearby trees. Unless the damage is extreme, the trees may not die immediately but could decline over several years. With this delay in symptom development, you may not associate the loss of the tree with the construction.

It is possible to preserve trees on building sites if the right measures are taken. The most important step is to hire a professional arborist during the planning stage. An arborist can help you decide which trees can be saved and can work with the builder to protect the trees throughout each construction phase.

#### How Trees Are Damaged During Construction

**Physical Injury to Trunk and Crown.** Construction equipment can injure the aboveground portion of a tree by breaking branches, tearing the bark, and wounding the trunk. These injuries are permanent and, if extensive, can be fatal.

**Cutting of Roots.** The digging and trenching that are necessary to construct a house and install underground utilities will likely sever a portion of the roots of many trees in the area. It is easy to appreciate the potential for damage if you understand where roots grow. The roots of a tree are found mostly in the upper 6 to 24 inches of the soil. In a mature tree, the roots extend far from the trunk. In fact, roots typically are found growing a distance of one to three times the height of the tree. The amount of damage a tree can suffer from root loss depends, in part, on how close to the tree the cut is made. Severing one major root can cause the loss of 5 to 20 percent of the root system.

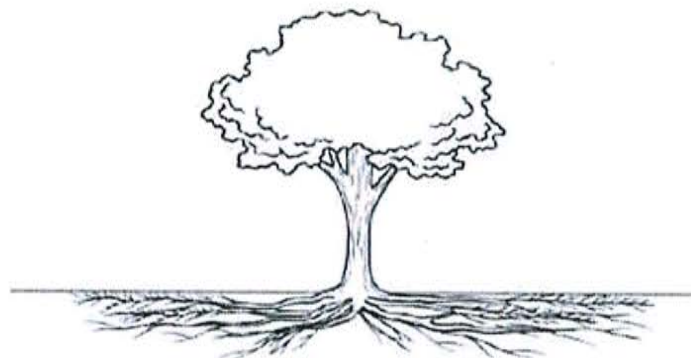

The roots of a tree extend far from the trunk and are found mostly in the upper 6 to 12 inches of soil.



Another problem that may result from root loss caused by digging and trenching is that the potential for the trees to fall over is increased. The roots play a critical role in anchoring a tree. If the major support roots are cut on one side of a tree, the tree may fall or blow over.

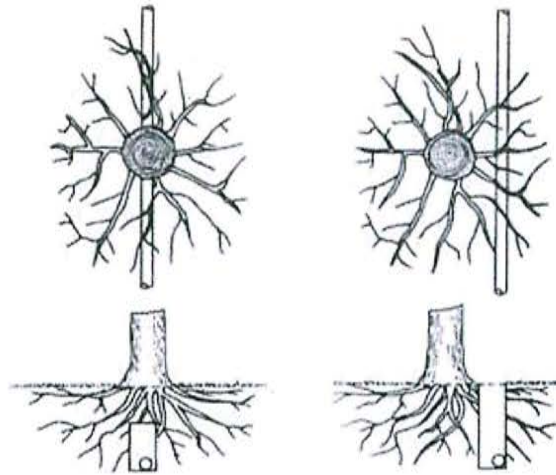

Less damage is done to tree roots if utilities are tunneled under a tree (right, top and bottom) rather than across the roots (left, top and bottom).

Less damage is done to tree roots if utilities are tunneled under a tree rather than across the roots.

**Soil Compaction.** An ideal soil for root growth and development is about 50 percent pore space. These pores—the spaces between soil particles—are filled with water and air. The heavy equipment used in construction compacts the soil and can dramatically reduce the amount of pore space. This compaction not only inhibits root growth and penetration but also decreases oxygen in the soil that is essential to the growth and function of the roots, and water infiltration.

**Smothering Roots by Adding Soil.** Most people are surprised to learn that 90 percent of the fine roots that absorb water and minerals are in the upper 6 to 12 inches of soil. Roots require space, air, and water. Roots grow best where these requirements are met, which is usually near the soil surface. Piling soil over the root system or increasing the grade smothers the roots. It takes only a few inches of added soil to kill a sensitive mature tree.

**Exposure to the Elements.** Trees in a forest grow as a community, protecting each other from the elements. The trees grow tall, with long, straight trunks and high canopies. Removing neighboring trees or opening the shared canopies of trees during construction exposes the remaining trees to sunlight and wind. The higher levels of sunlight may cause sunscald on the trunks and branches. Also, the remaining trees are more prone to breaking from wind or ice loading.

#### Getting Advice

Hire a professional arborist in the early planning stage. Many of the trees on your property may be saved if the proper steps are taken. Allow the arborist to meet with you and your building contractor.



Your arborist can assess the trees on your property, determine which are healthy and structurally sound, and suggest measures to preserve and protect them.

One of the first decisions is determining which trees are to be preserved and which should be removed. You must consider the species, size, maturity, location, and condition of each tree. The largest, most mature trees are not always the best choices to preserve. Younger, more vigorous trees usually can survive and adapt to the stresses of construction better. Try to maintain diversity of species and ages. Your arborist can advise you about which trees are more sensitive to compaction, grade changes, and root damage.

### Planning

Your arborist and builder should work together in planning the construction. The builder may need to be educated regarding the value of the trees on your property and the importance of saving them. Few builders are aware of the way trees' roots grow and what must be done to protect them.

Sometimes small changes in the placement or design of your house can make a great difference in whether a critical tree will survive. An alternative plan may be more friendly to the root system. For example, bridging over the roots may substitute for a conventional walkway. Because trenching near a tree for utility installation can be damaging, tunneling under the root system may be a good option.

### Erecting Barriers

Because our ability to repair construction damage to trees is limited, it is vital that trees be protected from injury. The single most important action you can take is to set up construction fences around all of the trees that are to remain. The fences should be placed as far out from the trunks of the trees as possible. As a general guideline, allow 1 foot of space from the trunk for each inch of trunk diameter. The intent is not merely to protect the aboveground portions of the trees but also the root systems. Remember that the root systems extend much farther than the drip lines of the trees.

Instruct construction personnel to keep the fenced area clear of building materials, waste, excess soil, and equipment. No digging, trenching, or other soil disturbance such as driving vehicles and equipment over the soil should be allowed in the fenced area.

Protective fences should be erected as far out from the trunks as possible in order to protect the root system prior to the commencement of any site work, including grading, demolition, and grubbing.

### Limiting Access

If at all possible, it is best to allow only one access route on and off the property. All contractors must be instructed where they are permitted to drive and park their vehicles. The construction access drive should be the route for utility wires; underground water, sewer, or storm drain lines; roadways; or the driveway.





Protective fences should be erected as far out from the trunks as possible in order to protect the root systems.

Specify storage areas for equipment, soil, and construction materials. Limit areas for burning (if permitted), cement wash-out pits, and construction work zones. These areas should be away from protected trees.

### Specifications

Specifications are to be put in writing. All of the measures intended to protect your trees must be written into the construction specifications. The written specifications should detail exactly what can and cannot be done to and around the trees. Each subcontractor must be made aware of the barriers, limitations, and specified work zones. It is a good idea to post signs as a reminder.

Fines and penalties for violations should be built into the specifications. Not too surprisingly, subcontractors are much more likely to adhere to the tree preservation clauses if their profit is at stake. The severity of the fines should be proportional to the potential damage to the trees and should increase for multiple infractions.

### Maintaining Good Communications

It is important to work together as a team. You may share clear objectives with your arborist and your builder, but one subcontractor can destroy your prudent efforts. Construction damage to trees is often irreversible.

Visit the site at least once a day if possible. Your vigilance will pay off as workers learn to take your wishes seriously. Take photos at every stage of construction. If any infraction of the specifications does occur, it will be important to prove liability.

### Final Stages

It is not unusual to go to great lengths to preserve trees during construction, only to have them injured during landscaping. Installing irrigation systems and roto-tilling planting beds are two ways the root systems of trees can be damaged. Remember also that small increases in grade (as little as 2 to 6 inches) that place additional soil over the roots can be devastating to your trees. ANSI A300



Standards Part 5 states that tree protection shall be in place for the landscape phase of the site development. Landscape tree protection may be different than other construction process tree protection, and a conference with the landscape contractor should be held prior to the commencement of the landscape work. Careful planning and communicating with landscape designers and contractors is just as important as avoiding tree damage during construction.

#### Post-Construction Tree Maintenance

Your trees may require several years to adjust to the injury and environmental changes that occur during construction. The better construction impacts are avoided, the less construction stress the trees will experience. Stressed trees are more prone to health problems such as disease and insect infestations. Talk to your arborist about continued maintenance for your trees. Continue to monitor your trees, and have them periodically evaluated for declining health or safety hazards.

Despite the best intentions and most stringent tree preservation measures, your trees still might be injured from the construction process. Your arborist can suggest remedial treatments to help reduce stress and improve the growing conditions around your trees. In addition, the International Society of Arboriculture offers a companion to this brochure titled "Treatment of Trees Damaged by Construction".

Edited from the 's tree protection guidelines





## California Tree and Landscape Consulting, Inc.

### GORDON MANN

#### EDUCATION AND QUALIFICATIONS

- |             |  |
|-------------|--|
| 1977        | Bachelor of Science, Forestry, University of Illinois, Champaign.                                  |
| 1982 - 1985 | Horticulture Courses, College of San Mateo, San Mateo.   |
| 1984        | Certified as an Arborist, WE-0151A, by the International Society of Arboriculture (ISA).           |
| 2004        | Certified as a Municipal Specialist, WE-0151AM, by the ISA.  |
| 2011        | Registered Consulting Arborist, #480, by the American Society of Consulting Arborists (ASCA).      |
| 2003        | Graduate of the ASCA Consulting Academy.   |
| 2006        | Certified as an Urban Forester, #127, by the California Urban Forests Council (CaUFC).             |
| 2011        | TRACE Tree Risk Assessment Certified, continued as an ISA Qualified Tree Risk Assessor (T.R.A.Q.). |

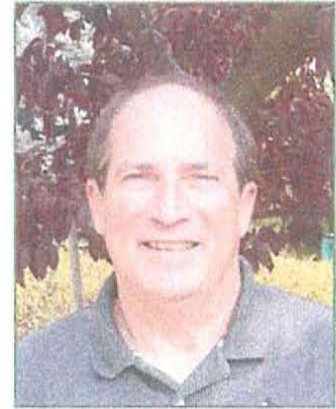

#### PROFESSIONAL EXPERIENCE

- 2016 – Present CALIFORNIA TREE AND LANDSCAPE CONSULTING, INC (CalTLC). President and Consulting Arborist.  
Auburn. Mr. Mann provides consultation to private and public clients in health and structure analysis, inventories, management planning for the care of trees, tree appraisal, risk assessment and management, and urban forest management plans.
- 1986 - Present MANN MADE RESOURCES. Owner and Consulting Arborist. Auburn.  
Mr. Mann provides consultation in municipal tree and risk management, public administration, and developing and marketing tree conservation products.
- 2015 – 2017 CITY OF RANCHO CORDOVA, CA. Contract City Arborist.  
Mr. Mann serves as the City's first arborist, developing the tree planting and tree maintenance programs, performing tree inspections, updating ordinances, providing public education, and creating a management plan,
- 1984 – 2007 CITY OF REDWOOD CITY, CA. City Arborist, Arborist, and Public Works Superintendent.  
Mr. Mann developed the Tree Preservation and Sidewalk Repair Program, supervised and managed the tree maintenance program, performed inspections and administered the Tree Preservation Ordinance. Additionally, he oversaw the following Public Works programs: Streets, Sidewalk, Traffic Signals and Streetlights, Parking Meters, Signs and Markings, and Trees.
- 1982 – 1984 CITY OF SAN MATEO, CA. Tree Maintenance Supervisor.  
For the City of San Mateo, Mr. Mann provided supervision and management of the tree maintenance program, and inspection and administration of the Heritage Tree Ordinance.
- 1977 – 1982 VILLAGE OF BROOKFIELD, IL. Village Forester.  
Mr. Mann provided inspection of tree contractors, tree inspections, managed the response to Dutch Elm Disease. He developed an in-house urban forestry program with leadworker, supervision, and management duties to complement the contract program.
- 1979 - Present INTERNATIONAL SOCIETY OF ARBORICULTURE. Member.  
●Board of Directors (2015 - Present)



- True Professional of Arboriculture Award (2011); In recognition of material and substantial contribution to the progress of arboriculture and having given unselfishly to support arboriculture.

- 1982 - Present WESTERN CHAPTER ISA (WCISA). Member.
- Chairman of the Student Committee (2014 - 2017)
  - Member of the Certification Committee (2007 - Present)
  - Chairman of the Municipal Committee (2009 - 2014) • Award of Merit (2016) In recognition of outstanding meritorious service in advancing the principles, ideals and practices of arboriculture.
  - Annual Conference Chair (2012)
  - Certification Proctor (2010 – Present)
  - President (1992 - 1993)
  - Award of Achievement and President's Award (1990)
- 1985 - Present CALIFORNIA URBAN FORESTS COUNCIL (CaUFC). Member; Board Member (2010 - Present)
- 1985 - Present SOCIETY OF MUNICIPAL ARBORISTS (SMA). Member. e Legacy Project of the Year (2015) o In recognition of outstanding meritorious service in advancing the principles, ideals and practices of arboriculture.
- Board Member (2005 - 2007)
- 2001 - Present AMERICAN SOCIETY OF CONSULTING ARBORISTS.  
Member. e Board of Directors (2006 - 2013)
- President (2012)
- 2001 - Present CAL FIRE. Advisory Position.
- Chairman of the California Urban Forestry Advisory Committee (2014 - 2017)
- 2007 – Present STANDARDS AMERICAN NATIONAL STANDARDS INSTITUTE (ANSI): A300 TREE MAINTENANCE COMMITTEE. SMA Representative and Alternate.
- Alternative Representative for SMA (2004 - 2007; 2012 - Present)
  - Representative for SMA (2007 - 2012)
- 2007 - Present SACRAMENTO TREE FOUNDATION. Member and Employee.
- Co-chair/member of the Technical Advisory Committee (2012 - Present)
  - Urban Forest Services Director (2007 - 2009) e Facilitator of the Regional Ordinance Committee (2007 - 2009)
  - 1988 - 1994 TREE CLIMBING COMPETITION.
    - Chairman for Northern California (1988 - 1992)
    - Chairperson for International (1991 - 1994)

#### PUBLICA TIONS AND LECTURES

Mr. Mann has authored numerous articles in newsletters and magazines such as Western Arborist, Arborist News, City Trees, Tree Care Industry Association, Utility Arborists Association, CityTrees, and Arborists Online, covering a range of topics on Urban Forestry, Tree Care, and Tree Management. He has developed and led the training for several programs with the California Arborist Association. Additionally, Mr. Mann regularly presents at numerous professional association meetings on urban tree management topics.



## **Assumptions and Limiting Conditions**

1. Consultant assumes that any legal description provided to Consultant is correct and that title to property is good and marketable. Consultant assumes no responsibility for legal matters. Consultant assumes all property appraised or evaluated is free and clear, and is under responsible ownership and competent management.
2. Consultant assumes that the property and its use do not violate applicable codes, ordinances, statutes or regulations.
3. Although Consultant has taken care to obtain all information from reliable sources and to verify the data insofar as possible, Consultant does not guarantee and is not responsible for the accuracy of information provided by others.
4. Client may not require Consultant to testify or attend court by reason of any report unless mutually satisfactory contractual arrangements are made, including payment of an additional fee for such Services as described in the Consulting Arborist Agreement.
5. Unless otherwise required by law, possession of this report does not imply right of publication or use for any purpose by any person other than the person to whom it is addressed, without the prior express written consent of the Consultant.
6. Unless otherwise required by law, no part of this report shall be conveyed by any person, including the Client, the public through advertising, public relations, news, sales or other media without the Consultant's prior express written consent.
7. This report and any values expressed herein represent the opinion of the Consultant, and the Consultant's fee is in no way contingent upon the reporting of a specific value, a stipulated result, the occurrence of a subsequent event or upon any finding to be reported.
8. Sketches, drawings and photographs in this report, being intended as visual aids, are not necessarily to scale and should not be construed as engineering or architectural reports or surveys. The reproduction of any information generated by architects, engineers or other consultants and any sketches, drawings or photographs is for the express purpose of coordination and ease of reference only. Inclusion of such information on any drawings or other documents does not constitute a representation by Consultant as to the sufficiency or accuracy of the information.
9. Unless otherwise agreed, (1) information contained in this report covers only the items examined and reflects the condition of those items at the time of inspection; and (2) the inspection is limited to visual examination of accessible items without dissection, excavation, probing or coring. Consultant makes no warranty or guarantee, express or implied that the problems or deficiencies of the plans or property in question may not arise in the future.
10. Loss or alteration of any part of this Agreement invalidates the entire report.



## **Certificate of Performance**

I, Gordon Mann, certify that:

I have personally inspected the trees and site referred to in this report, and have stated my findings accurately. The extent of the inspection is stated in the attached report under Assignment;

I have no current or prospective interest in the vegetation, or the property that is the subject of this report and have no personal interest or bias with respect to the parties involved;

The analysis, opinions and conclusions stated herein are my own and are based on current scientific procedures and facts;

My analysis, opinions, and conclusions were developed, and this report has been prepared according to commonly accepted arboricultural practices;

No one provided significant professional assistance to me, except as indicated within the report;

My compensation is not contingent upon the reporting of a predetermined conclusion that favors the cause of the client, or any other party, nor upon the results of the assignment, the attainment of stipulated results, or the occurrence of any subsequent events.

I further certify that I am a member in good standing of the International Society of Arboriculture (ISA) and an ISA Certified Arborist and Municipal Specialist. I am also a Registered Consulting Arborist member in good standing of the American Society of Consulting Arborists. I have been involved in the practice of arboriculture and the care and study of trees for over 39 years.

Signed:

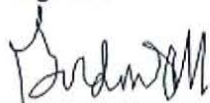

Gordon Mann

Date: February 28, 2018



# El Dorado County

## OAK/CANOPY SITE ASSESSMENT FORM

<b>Qualified Professional &amp; Contact Information:</b> <i>(attach qualifications) resume in report</i>	Gordon Mann, Consulting Arborist & Urban Forester 10566 Combie Rd, PMB 6442, Auburn, CA 95602	
<b>Property Owner's Name/APN(s):</b>	Pacific State Development / 120-010-01	
<b>Address:</b>	Beatty Drive, El Dorado Hills, CA	
<b>General Plan Designation:</b>	HDR	
<b>Zoning:</b>	R1	
<b>Project Description:</b> <i>(attach site photos)</i>	46 Single Family Residential Lots	
<b>Would the project, directly or indirectly, have the potential to cause any impact, conflict with, or disturbance to:</b>	<b>YES</b>	<b>NO</b>
a) Individual landmark or heritage trees (of any species) subject to review under General Plan Policy 7.4.5.2?		✓
c) Oak woodland corridor continuity (General Plan Policy 7.4.4.5)?		✓
d) Sensitive or important oak woodland habitat as defined in the Guidelines?		✓
e) Movement of Wildlife and/or Any Wildlife Migration Corridor?		✓
f) Any Candidate, Listed or Special Status Plant or Animal Species observed or expected to occur on or adjacent to the project site?	✓	
g) Is the affected area of oak canopy within or directly adjacent to an Important Biological Corridor or Ecological Preserve overlay?		✓
h) Does the removal of oak canopy comply with the retention requirements of Policy 7.4.4.4?	✓	
i) Was project subject to prior County approval? (If yes, provide Tentative Map # and environmental documents if available) TM 88-1125	✓	
j) For Discretionary Projects, would the project have the potential to cause a significant environmental impact on biological resources?		✓
<i>I affirm that all of the information contained in this document is true and correct to the best of my knowledge and I acknowledge and agree that any material misinformation in this document can result in the denial or revocation of any permits or County approvals for this project.</i>		
<b>Qualified Professional:</b> <u>Gordon Mann</u>	<b>Date:</b> <u>5/31/12</u>	
<b>Applicant/Owner:</b> _____	<b>Date:</b> _____	

**Required Attachments:** 1) Qualified Professional Qualifications; 2) Site Photos; 3) Required Tree Survey, Preservation, and Replacement Plan or Biological Resources Study and Important Habitat Mitigation Program (see Interim Interpretive Guidelines for El Dorado County Policy 7.4.4.4 Option A)



# **ARBORIST REPORT FOR RIDGEVIEW VILLAGE NO. 9 OAK TREE CANOPY MITIGATION PLAN**

**Prepared by Gordon Mann, Consulting Arborist and Urban Forester**

Mann Made Resources  
10566 Combie Road PMB 6442  
Auburn, CA 95602  
May 31, 2012

**TM 08-1477-R**



## Table of Contents

Assignment .....	1
Observations .....	1
Other testing or examination .....	2
Discussion .....	2
<u>Biological Resources Study</u>	
Summary of Recommendations .....	3
Oak Tree Canopy.....	3
Potential Impact Assessment .....	4
<u>Oak Mitigation Plan</u>	
Mitigation Plan .....	6
Safeguarding Trees During Construction .....	6
Safeguarding Trees after Construction .....	7
Revegetation and Restoration Plan .....	7
Monitoring and Reporting Plan .....	8
Funding Mechanism .....	8
Findings and Recommendations .....	8
Certification .....	8
Assumptions and Limitations .....	8
Report Certification .....	9
<u>Appendices</u>	
Oak Woodland Conservation Easement Photos .....	11
Gordon Mann Resume .....	13
Ridgeview Village Tree Canopy Inspection Data .....	15





## Mann Made Resources

May 31, 2012

Mr. Bill Fisher  
Pacific State Development Corp  
991 Governor Drive, Suite 101  
El Dorado Hills, CA 95762

**SUBJECT: ARBORIST REPORT FOR RIDGEVIEW VILLAGE UNIT #9 OAK  
TREE CANOPY MITIGATION PLAN**

Dear Mr. Fisher,

Thank you for the opportunity to provide Arborist Consulting Services. This report includes the observations and analysis of the Oak tree canopy for the Ridgeview Village Unit 9 project. The site was visited on Thursday, May 24, 2012.

**Assignment:** Ms. Olga Sciorelli from CTA Engineering and Survey contacted my office on your behalf on Monday, May 14, 2012, requesting assistance with an arborist site review and evaluation of the tree canopy maps to prepare for compliance with the El Dorado County General Plan Policy 7.4.4.4 and its Interim Interpretive Guidelines. A report confirming the findings and complying with the County's interim guidelines was the requested product.

All site information, plans, and history were provided by Ms. Olga Sciorelli of CTA Engineering and Surveying, and Mr. Bill Fisher of Pacific States Development Corp. The Ridgeview Village Unit 9 Tree Preservation Plan dated April 2012 was provided for review and use. A copy of the original tree inventory plan and Ridgeview Village Unit 9 Photo exhibit were provided for more accurate site review.

The assignment required the following activities: visit the site, verify the canopy cover as shown on the Ridgeview Village #9 Tree Preservation Map dated April 2012, identify trees that I found to be dead and non-Oak removed from the canopy, and complete the report. The "Results of Special-Status Plant Surveys on the Ridgeview Unit 9 Property, El Dorado Hills, El Dorado County, California" performed by Miriam Green Associates, and the "Jurisdictional Delineation and Special Status Species Evaluation Ridgeview Unit 9 Property" performed by Gibson & Skordal, LLC were reviewed prior to completing this report.

**Observations:** The project area is approximately 22.4 acres. The Ridgeview Village No. 9 site and proposed Oak Woodland Conservation Easement were

12661 Torrey Pines Drive, Auburn, CA 95602  
(650) 740-3461 ♦ FAX (530) 268-0926  
[www.mannandtrees.com](http://www.mannandtrees.com)



visited on Thursday, May 24, 2012 from about 11:30 am through 3:00 pm. The Tree Preservation Map dated April 2012 was made available for use along with an April 2011 Photo Exhibit of Ridgeview Village Unit 9, and a copy of the original tree survey. I visited the entire site and compared the canopy to the canopy image on the map sheets, and identified the trees to be removed from the canopy.

The site extends across Beatty Drive. The areas of focus for the proposed project are the three proposed streets, courts A, B, and C on the north and northeast side of Beatty Drive.

I visually observed the trees on the site from the ground. The trunk diameter at 4.5' above grade was estimated for reference. The trees were observed noting the following conditions:

- Tree species
- Tree crown – amount and location of live foliage
- Tree structure – location and amount of decay in trunk, root crown, and crotches; broken bases; and deficiencies of branch or trunk attachment strength;
- Trunk flare and root crown – absence of buttress roots and decay at base

A total of 18 trees were listed on the attached spreadsheet. 13 trees were Blue Oak, *Quercus douglasii*, two trees were Interior Live Oak, *Quercus wislizenii*, and three trees were Digger Pine, *Pinus sabiniana*.

The remaining trees observed on the property were found to be in a condition consistent with native grown Oak trees and would not present significant risk as cared for with routine maintenance pruning to remove dead and broken branches with reasonable reduction to the foliar crown. These trees were not listed on the survey spreadsheet and were not altered in their appearance on the Tree Preservation Map.

After inspecting the trees on the Ridgeview Village No. 9 site, I visited and photographed the proposed Oak Woodland Conservation Easement site.

On May 30, 2012, at about 10:15 am, I visited the office of CTA Engineering and Surveying and reviewed edits to the Ridgeview Village Unit 9 Tree Preservation Map with Ms. Olga Sciorelli.

**Other testing or examination:** No other testing or examination was requested at the time of the site inspection, or recommended as a result of the inspection.

**Discussion:** I observed the trees to determine which trees were growing in the three court areas, and were found to be in fair or better health, structurally sound, and contribute to the existing canopy. Trees that were included in the Oak canopy that were dead or non-oak were listed for removal from the canopy calculations.

Trees in the remaining lot areas were observed to determine if any trees should be removed from the Oak canopy calculations.



I based my assessment of tree condition on a combination of structure and health and listed trees to be removed when I found any of the following criteria:

- The tree crown dieback was greater than 50% dead
- Decay in trunks, main crotches, and branches exceeded 50% of the diameter or > than 33% of the circumference was decayed
- The base of the tree was decayed greater than 50%
- Tree roots were missing from greater than 33% of the circumference of the trunk flare.
- Heavy mistletoe infestation is causing structural or leaf competition concerns in greater than 33% of the crown.
- Combinations of the above

Using the above criteria, the trees are dead; trees would either require excessive pruning to reduce risk of dead or weak branches, or the stability concerns cannot be corrected by typical pruning or cabling mitigation. Trees that could be pruned and still retain a typical smaller foliar crown and moderate or less structural risk were listed for pruning and the crown size reduced accordingly in the canopy displayed on the Tree Preservation Map. Trees that were found to be dead or non-oak were captured so the crown size could be removed from the Oak canopy displayed on the Tree Preservation Map. June map was created from the field data

After the site and office visit, the field data and canopy adjustments were updated on the Ridgeview Village # 9 Tree Preservation Map, June, 2012. The total site is 22.4 acres. The total existing Oak Canopy Cover is 14.198 acres, and 63.4% existing Oak canopy cover. The allowable canopy removal in the County guidelines for this level of canopy cover is up to 30%.

## **Biological Resources Study and Important Habitat Mitigation Program**

### **Biological Resources Study**

#### **2.1.1.1 Summary of Recommendations**

The site is primarily populated with Blue Oak, *Quercus douglasii*, and few Interior Live Oak, *Quercus wislizenii*. Other species are found on the site, such as Cottonwood, California Buckeye, and Digger Pine, and non-Oaks were not included in the Oak canopy calculations. The current property use is open space adjacent to other housing, with two paved roads running through the property.

#### **2.1.1.2 Oak Tree Canopy**

The County Guidelines require a table showing the Oak Canopy Coverage. There is an existing inventory of trees for the site. The map from that inventory was used in identifying trees on the plan for the canopy analysis.

The total site Oak canopy is approximately 14.198 acres or 63.38% of the project site. The allowable removal under "Option A" of the County development guidelines allows up to 30% of the existing Oak Canopy to be removed, or approximately 4.25 acres. An equal 4.25 acres of mitigation area is required.



The mitigation may be phased such that tree removal associated with street and infrastructure grading, and grading construction of single family dwellings and accessory structures will occur with approved project steps. The project is proposed to result in the following tree mitigation allocation:

Option	Activity	Mitigation Acreage
Option A	Roads and Grading	1.26
Option A	Off-Site Sewer Line	0.07 (performed as on-site)
Option A	Lots Only by lot owner	2.92
Option B	Lots only by lot owner	Varies by lot owner as approved to meet future County guidelines

The total number of trees to be removed is determined to be 87 for Option A Roads and Grading. The number of trees to be removed on lots by homeowners cannot be determined until the owner designs are reviewed and approved.

Dead, dying, and diseased trees identified on the site inspection list were not included in Table canopy cover per the County the guidelines. Those trees are shown on the plans as Dead, Diseased, and Dying Oak Trees and are excluded from canopy cover calculations.

The canopy cover loss shown in Table 1 includes 0.07 acres, for off-site sewer line construction. The 0.07 acres has been added to the on-site Oak tree mitigation plan calculations included in the 4.25 acres for the Ridgeview Village # 9 property, as the applicant does not have the right to complete mitigation and monitoring on the off-site properties where the off-site removals are proposed.

The existing total site canopy cover is 63.38%. The allowable canopy cover elimination in the guidelines is up to 30% for this level of existing canopy cover. The project is being divided into two tree removal phases, Option A, Roads and grading, and Option A, lots for construction of homes. The allowable canopy cover removal for proposed Option A is 4.25 acres. The proposed total canopy cover removal for Option A is 4.25 acres, within the 30% guideline.

The remaining canopy may be removed under GPP 7.4.4.4 Option B, which is not available at the time of preparation of this report.

### **2.1.1.3 Potential Impact Assessment**

The Jurisdictional Delineation and Special Status Species Evaluation prepared by Gibson and Skordal, LLC and the special status Plant Surveys by Miriam Green Associates address the plant and animal species and habitats found on the property. Please refer to their reports for this information.

The percent plant communities and habitats to be removed or modified by this project was calculated by the Oak canopy being eliminated.



The project may have the potential impacts in response to questions a) through p) in section 2.1.1.3:

- a) The tree removal and development proposed in Option A affects the oaks on the property, reducing density, canopy, and understory vegetation. There was minimal signs of Oak regeneration present. The oak removal is within the county guidelines for the Oak canopy present.
- b) There should be no additional affect on potential oak woodland regeneration in Option A. The current regeneration is already limited.
- c) The report from Gibson & Skordal did not observe any of the potential species, although it did state that if future development of the study area will occur during the raptor nesting season, from February to September, a pre-construction nesting survey is recommended to be completed within two weeks of the start of work.
- d) There are no identified heritage or archaeological trees on the site.
- e) There are no apparent habitat distribution patterns that would be fragmented.
- f) The Miriam Green Associates report did not find any sensitive or endangered species.
- g) There were no sensitive wildlife or plant species identified by the Miriam Green Associates and Gibson & Skordal surveys.
- h) The property to be developed in Option A is not considered a critical buffer between development and important oak resource. The area has other development on adjacent properties.
- i) The change in management will not result in increased fire hazard to sensitive or important woodlands.
- j) The site construction and roads may increase runoff on the site. There is a previous roadway present on the property that is being removed when Court C is constructed. The approved stormwater mitigation should not result in any downstream sedimentation, erosion, or decrease in water quality.
- k) The impact to the oak woodland does not affect sensitive or important botanical plants according to the Miriam Green Associates report. The property is under private control and there should be no impacts to recreation activities. There may be some viewshed impacts for properties that can view the property once developed, similar to other developments in the area.
- l) There are no sensitive oak habitats being affected per the county's 2004 General Plan Land Use Diagram.
- m) The site does not contain sensitive Oak stands according to the guideline definition.
- n) There is no fragmentation of sensitive oak woodland habitat according to the guideline definition
- o) The oak woodland corridors are already fractured and interrupted surrounding this site.
- p) There is not a Biological Corridor Overlay or Ecological Preserve present.



### **Mitigation Plan**

The existing Oak canopy cover on the site is 63.38% and falls within in the 60 to 79 percent existing canopy cover range for mitigation requirements. The required retention of canopy is 70% canopy cover based on Policy 7.4.4.4, Option A. Thirty percent of the existing Oak canopy on the site would remove 4.25 acres of Oak canopy. The 4.25 acres of Oak tree canopy removal is broken down into 3 areas: Tree removal for project Option A roads and grading - 1.26 acres, and off-site sewer line – 0.07 acres, both performed by the developer; Option A removal for lots by lot owners – 2.92 acres.

Under County Mitigation Option A, woodland replacement is required at a 1:1 ratio of square feet or acreage removed. The developer is proposing to provide an Oak Woodland Conservation Easement on APN: 120-166-29 (Lot D) with an area of 6.38 acres available. The Oak Woodland canopy available for use in the easement area was calculated as 5.66 acres in March, 2012. This provides the required 4.25 acres and leaves an available mitigation surplus of 1.41 acres for future tree removal. The site was visited and will serve as a suitable conservation easement area for county oak woodland preservation. Four photos of the proposed easement site are included in the appendix.

### **Safeguarding Trees During Construction**

Proposed Option A for roads and sewer line construction will require the removal of the designated trees in the road and sewer construction footprints. The trees shall be adequately marked for removal and trees beyond the removal zone protected so they are retained and not damaged by the tree removal operations.

The remaining existing trees in these identified lots shall be protected from construction impacts by placing temporary fencing around the Tree Protection Zone, which will be calculated at a minimum of six times the trunk diameter of the tree to be retained, measured at 4.5 feet above grade. Stakes may be driven into the ground to support the fence, or sturdy on surface footings may be used. The fencing shall remain in place during the construction and landscaping activities. Any approved construction or landscaping within the fenced area will have clear specifications that include hand excavation or trenchless tunneling under roots, placement of mulch over the soil to reduce compaction, and supplemental irrigation as recommended by the project arborist depending on dust, temperature, and precipitation.

Grading and fill work should not be planned within the Tree Protection Zone. If an unavoidable situation occurs, any grading and fill shall be supervised by an arborist or trained competent person to minimize compaction to the soil and impacts to the tree.

Any excavation that will cause roots to be cut on trees to be retained shall have a trained person observing the careful excavation. All roots encountered greater than one inch in diameter shall be severed prior to further digging, to avoid tearing the root back toward the tree to be retained. The root severance shall be performed with the appropriate sharp tool, a lopper, hand saw, or chain saw. Once the root is severed, the cut portion in the site work area can be excavated.



Fill shall be kept a minimum distance of six times the trunk diameter, measured at 4.5 feet above grade, from the tree to be retained. If the distance has to be closer for required conditions like fire access, mitigation shall be implemented such as: keeping the fill as far from the tree as possible, and a minimum of 36 inches; placement of a geotextile over the existing soil; placement of coarse fill over the geotextile to meet the critical final grade of the base or roadway bed; and an adequate retaining structure to hold the height of the fill in place away from the tree. The method of installing the fill shall not cause compaction to the soil within the Tree Protection Zone.

Construction activities, vehicle and equipment storage, parking, fluids other than water, chemicals, paints, or construction materials shall not be stored within the area fenced around trees.

Drains and directed surface water flow shall be directed away from the base of oak trees. The tree shall not be designed as the low point for water flow unless an adequate method to move the water away from the base of the tree is implemented. Irrigation lines shall either be laid upon the surface or installed with careful excavation that avoids severing roots greater than 1 inch in diameter.

Wires, signs, and nails shall not be attached to protected trees. No open flames shall be allowed within 15 feet of a tree foliar canopy.

Damage to any protected tree shall be immediately reported to the County's Planning Services.

#### **Safeguarding Trees after Construction**

Trees required to be retained, and trees planted to meet requirements shall be maintained in a manner that protects the trees from detrimental practices. Irrigation for landscapes shall be designed to start at the minimum distance of 48 inches from the base of the protected oak tree and deliver water outward away from the tree. Drainage patterns shall be directed away from the tree. If the tree is the low point in the design and water flows around the base, a drain or adequate method to move water away from the base of the tree shall be provided. Mulch is recommended over the root systems and covering bare soil around trees. The best mulch materials are ground-up tree parts (wood chips). Wood chip mulch can be colored to be used in decorative designs. Decorative bark products, such as Cedar or Redwood bark, do not easily decompose, and while they cover the soil, they do not add desired organic matter to the soil. Mulch shall not be piled against nor placed over the trunk flare greater than one inch. The final landscape plan is subject to the approval of the Director of Development Services.

#### **Revegetation and Restoration Plan**

The mitigation plan is to designate the Oak Woodland Conservation easement on APN: 120-166-29 (Lot D) and match the removed oak canopy with easement oak canopy. The site is in close proximity to the Ridgeview Village # 9 site located behind lots fronting Ridgeview Drive and Patterson Way. There are two access



points to the easement parcel from Patterson Way at two locations on the parcel, and the parcel is adjacent to a proposed conservation easement.

The developer will provide the county with the appropriate terms, conditions and endowments for monitoring and management deemed necessary by the County.

The Conservation easement is preferable to on-site replanting on the Ridgeview Village No. 9 site and supported by:

- The level of protection of the habitat is superior in an existing mature oak stand compared to seedlings planted amongst  $\frac{1}{3}$  to  $\frac{1}{2}$  acre home sites (General Plan Policy 7.4.2.8D)
- The regional consideration of “connectivity with adjacent protected lands and important habitat” (General Plan Policy 7.4.2.8D) is superior on Lot D, since contiguous to the proposed conservation easement is an oak filled 4.4 acre El Dorado Hills Community Services District park site. Use of Lot D “achieves multiple agency and community benefits” (General Plan Policy 7.4.2.8D)

#### **Monitoring and Reporting Plan**

The developer will provide the county with the appropriate terms, conditions and endowments for monitoring and management deemed necessary by the County.

#### **Funding Mechanism**

The developer will provide the county with the appropriate terms, conditions and endowments for monitoring and management deemed necessary by the County.

#### **Findings and Recommendations**

The inspections, findings, and recommendations for this project plans and mitigation are presented with practices in alignment with International Society of Arboriculture best management practices associated with development and tree preservation, and mitigation planting, and the appropriate parts of the ANSI A300 Tree Management Standards. The intent of the tree related specifications is to minimize impacts and be sufficient to protect the remaining oak resources on the subject property, as required by El Dorado County General Plan, and CEQA.

#### **Certification**

I performed the site inspections and canopy evaluation on the project site. As the plans were prepared, I reviewed the calculations, images, and map, and am confident they are accurate as presented. The calculations are valid based on my field survey and map review. I meet the county's qualifications to perform this work. My resume is attached.

**Assumptions and Limitations:** This report provides information about the subject trees at the times of the inspection. Trees and conditions may change over time. This report is only valid for the trees with the conditions present at the times of the inspections. All observations were made while standing on the ground. The inspection consisted of visual observations, using probe to gain additional information about decay and hollow portions of the tree, and light excavation was performed to observe the root crown areas at the base of the tree. No further examinations were requested or performed.



The site lacked many clear topographic and structural landmarks. Sincere attempts were made to accurately locate the trees and show the trees on the Tree Preservation Map. Some dense stand areas may not have the exact tree shown as observed in the field. However, the relative canopy changes are realistically and accurately reflected on the Tree Preservation Map to the best of my ability.

Arborists are tree specialists who use their education, knowledge, training and experience to examine trees, recommend measures to enhance the beauty and health of trees, and attempt to reduce the risk of living near trees. Clients may choose to accept or disregard the recommendations of the arborist, or seek additional advice.

Arborists cannot detect every condition that could possibly lead to the structural failure of a tree. Trees are living organisms that can fail in ways we do not fully understand. Conditions are often hidden within trees and below ground. Arborists cannot guarantee that a tree will be healthy or safe under all circumstances, or for a specified period of time. Likewise, remedial treatments, like any medicine, cannot be guaranteed.

Treatments, pruning, and removal of trees may involve considerations beyond the scope of the arborist's services such as property boundaries, property ownership, site lines, disputes between neighbors, landlord-tenant matters, etc. Arborists cannot take such issues into account unless complete and accurate information is given to the arborist. The person hiring the arborist accepts full responsibility for authorizing the recommended treatment or remedial measures.

Trees can be managed, but they cannot be controlled. To live near a tree is to accept some degree of risk. The only way to eliminate all risks is to eliminate all trees. Our company goal is to help clients enjoy life with trees.

### **Report Certification**

I certify that all the statements furnished above in this report and the attached exhibits present the data and information required for this Arborist Report, and that the facts, statements, and information are true, complete, and correct to the best of my knowledge and belief, and that all statements were made in good faith.

Please contact me at 650-740-3461, or [gordon@mannandtrees.com](mailto:gordon@mannandtrees.com), if you have any questions about this report or desire any other services for this project.

Sincerely,

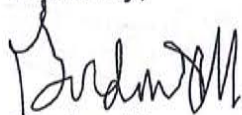

Gordon Mann  
Consulting Arborist and Urban Forester

Registered Consulting Arborist #480  
ISA Certified Arborist and Municipal Specialist #WE-0151AM  
CaUFC Certified Urban Forester #127  
Certified Tree Risk Assessor #1005  
Nevada County Fire Safe Council Defensible Space Advisory Training



Mann Made Resources  
Auburn, CA  
650-740-3461  
Fax 530-268-0926  
[gordon@mannandtrees.com](mailto:gordon@mannandtrees.com)  
[www.mannandtrees.com](http://www.mannandtrees.com)



# Appendices



## Appendix

The following four photos were taken of the Oak Woodland Conservation easement parcel 120-166-29. The parcel consists of an oak woodland consistent with the type of tree cover and species variety present on the Ridgeview Village # 9 site.

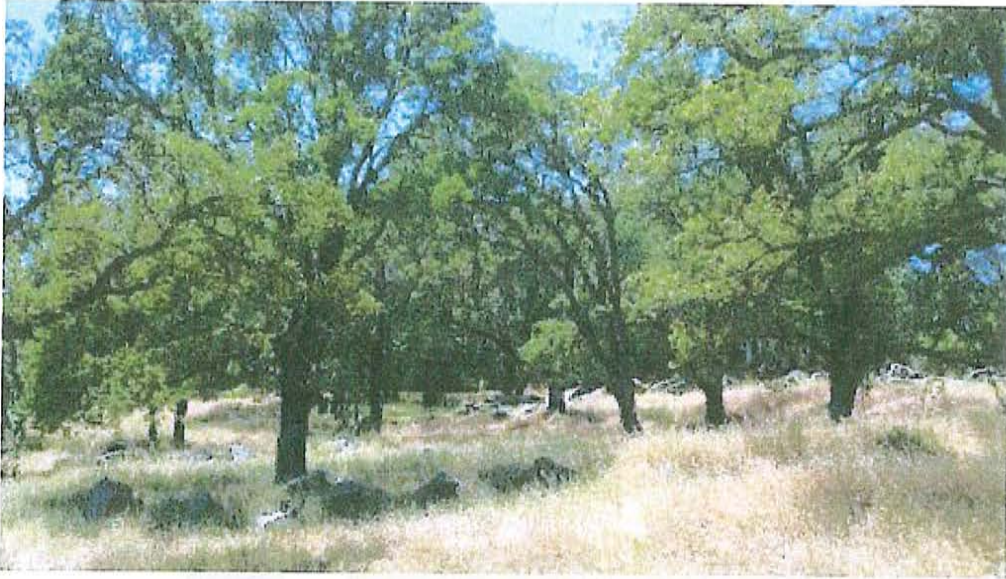



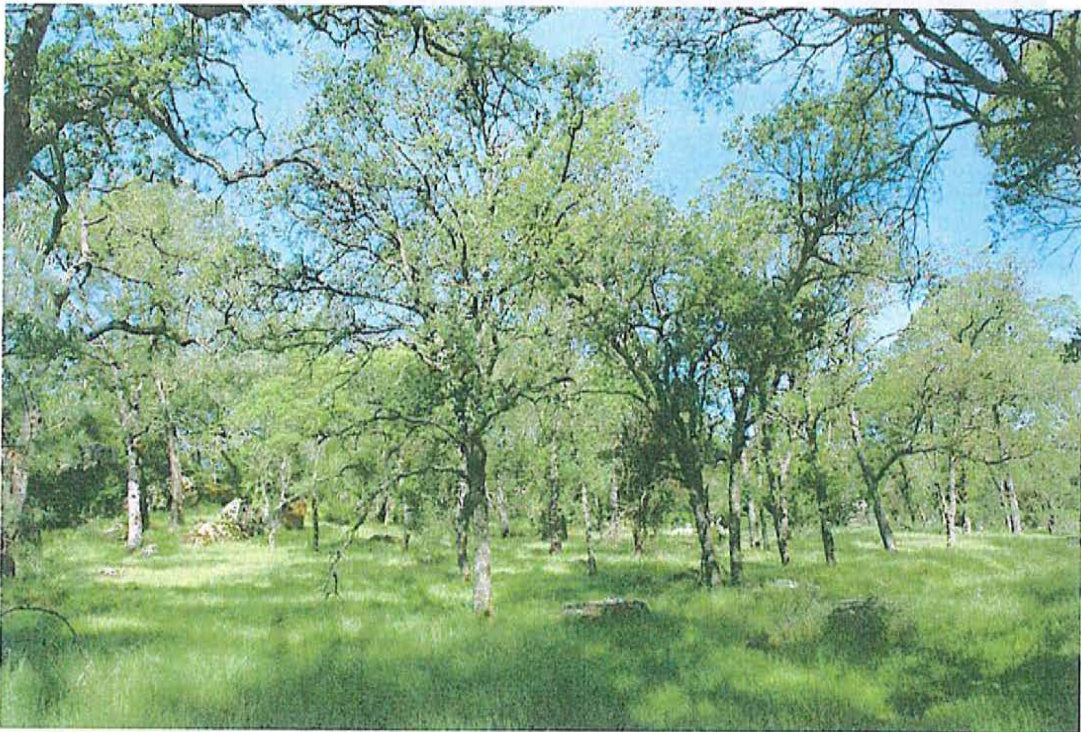



Gordon Mann  
Consulting Resume

Education:

B.S. Forestry, University of Illinois

Horticulture courses, College of San Mateo

Continuing Education sessions to maintain Certifications and ASCA membership

Awards, Certifications, and Professional Memberships:

Received the 2011 True Professional of Arboriculture award from ISA

Received 2011 Author's Citation from the Society of Municipal Arborists

Member American Society of Consulting Arborists (ASCA), Registered Consulting Arborist #480

Member International Society of Arboriculture (ISA), ISA Certified Arborist and Municipal Specialist #WE-0151 AM; PNWISA Certified Tree Risk Assessor # 1005

Member California Urban Forest Council (CaUFC), Certified Urban Forester #127

Member Western Chapter International Society of Arboriculture (WCISA)

Member Society of Municipal Arborists (SMA)

Member California Arborist Association (CAA)

Employment:

Owner Mann Made Resources, consulting and marketing tree friendly products, since 1986

Over 34 years in municipal tree and risk management, and public administration

- 1.5 years Full time consultant and product sales with Mann Made Resources
- 1 year with Fallen Leaf Tree Service as Sales/Municipal Manager/General Manager
- 1.5 years with the Sacramento Tree Foundation as Urban Forest Services Director
- 22.5 years with the City of Redwood City, CA as Arborist, City Arborist and Public Works Superintendent - Streets, Sidewalk, Traffic Signals and Markings, & Trees
- 2.5 years with the City of San Mateo, CA as Tree Maintenance Supervisor
- 5 years with the Village of Brookfield, IL as Village Forester

Professional Leadership:

Current President-Elect, American Society of Consulting Arborists (ASCA)

Current representative for SMA on American National Standards Institute (ANSI) A300 Tree Maintenance Standards Committee

Current Board Member California Urban Forests Council (CaUFC)

Current WCISA Municipal Committee chair, and member on Certification Committee

2012 WCISA Annual Conference Chair Asilomar, CA, April 29-May 2, 2012

Past President, Western Chapter International Society of Arboriculture

Past President, California Arborists Association

Past Board Member, Society of Municipal Arborists

Past chairperson (3 years) of the International Tree Climbing Competition

Past chairperson (13 years) of the Northern California Tree Climbing Competition

Past President, San Mateo Arboretum Society

Past President, CityTalk Toastmasters

Professional outreach:

- Developed and led training programs with the California Arborists Association
- Provided urban forestry and municipal arboriculture instruction in Sydney and Melbourne, Australia



- Presented urban forestry related sessions at regional and annual meetings with ASCA, ISA, SMA, ISA Chapters, CAA, PAPA, PNW-ISA, Sacramento Tree Foundation, APWA, Arbor Day Foundation, Maintenance Superintendents Association, and Oregon Department of Forestry, San Mateo County Stormwater Pollution Prevention Program
- Authored articles in newsletters and magazines including: Western Arborist, Arborist News, City Trees, and Utility Arborists Association
- Presented sessions on urban tree management topics at 2012 Colorado Pro-Green Conference, 2012 Idaho Hort Expo, 2012 WCISA Annual Conference, and 2012 Association of Environmental Professionals

**Key Projects:**

Performed risk assessment and tree risk management plan for Nevada Joint Union High School District, Grass Valley, CA; reference - Paul Palmer

Performed Urban Forest Program analysis Oakdale, CA; reference - Robert Swift

Performing Campus Urban Forest Management Plan San Francisco State University, San Francisco, CA; reference – Phil Evans







# RIDGEVIEW VILLAGE UNIT 9

## OFF-SITE SEWER THROUGH VILLADORO HOA LOT B (RIDGEVIEW WEST) TREE PRESERVATION ANALYSIS

EL DORADO COUNTY, CALIFORNIA  
SCALE: 1"=40' JANUARY, 2019

### LEGEND

CANOPY TO REMAIN (1996)



CANOPY TO BE REMOVED (2019)  
FOR RIDGEVIEW UNIT 9 OFF-SITE SEWER



### PROJECT AREA

RIDGEVIEW WEST LOT B:	347,653 SF
TOTAL CANOPY (1996):	196,518 SF
CANOPY REMOVAL (2019):	19,870 SF

### DISTURBED AREA

OFF-SITE SEWER LOT B:	1.2 AC
-----------------------	--------

### PROJECT NOTES

FROM STAFF REPORT, PAGE 8, FILE NO. 295-21/PD95-15/TM95-1309 RIDGEVIEW WEST, DATED JULY 11, 1996, ACCORDING TO POLICY 7.4.4.4, SINCE 80% OF THE TREE CANOPY IS RETAINED, A REPLACEMENT PLAN IS NOT NECESSARY. RIDGEVIEW WEST IS CONSISTENT WITH BOTH POLICIES 7.4.4.4 & 7.4.5.1.

### REFERENCE

\*CANOPY SHOWN IS FROM THE TREE PRESERVATION PLAN FOR RIDGEVIEW WEST, MARCH 1996

### TREE PRESERVATION PLAN ANALYSIS

- \*RIDGEVIEW WEST - JULY 1996
- \*REMOVE CANOPY (1996) 360,220 SF
- \*REMOVE CANOPY (2019) 19,870 SF
- \*TOTAL PROJECT CANOPY (1996) 2,076,647 SF
- \*ORIGINAL CANOPY TO BE REMOVED IS 17% (1996)
- \*CURRENT TOTAL CANOPY REMOVAL IS 18% (2019)
- \*PROPOSED CANOPY TO BE RETAINED IS 82% (2019) THEREFORE SHOULD NOT REQUIRE MITIGATION (1996)

