

ORIGINAL



**COUNTY OF EL DORADO, CALIFORNIA
CHIEF ADMINISTRATIVE OFFICE
FACILITIES DIVISION**

CONTRACT DOCUMENTS

INCLUDING

**NOTICE TO BIDDERS,
PROPOSAL, CONTRACT,
AND CONDITIONS OF THE CONTRACT**

FOR

JOHNSON CENTER ROOF REHABILITATION PROJECT

BID #20-968-053

**BIDS MUST BE RECEIVED BY:
3:00 P.M. on JUNE 2, 2020
PROCUREMENT & CONTRACTS
330 FAIR LANE, PLACERVILLE, CA 95667**

**COUNTY OF EL DORADO
CHIEF ADMINISTRATIVE OFFICE
FACILITIES DIVISION**

JOHNSON CENTER ROOF REHABILITATION PROJECT

BID #20-968-053

TABLE OF CONTENTS

NOTICE TO BIDDERS	N-1
INSTRUCTIONS TO BIDDERS	I-1
PROPOSAL	P-1
DRAFT AGREEMENT FOR CONSTRUCTION SERVICES	C-1
CONTRACTOR'S GUARANTEE	NO PAGE #
PAYMENT BOND	NO PAGE #
PERFORMANCE BOND	NO PAGE #
CALIFORNIA FORM 590 - 2015 WITHHOLDING CERTIFICATE	NO PAGE #
COUNTY OF EL DORADO PAYEE DATA RECORD FORM	NO PAGE #
CERTIFICATE OF INSURANCE FORM	NO PAGE #
CONDITIONS OF THE CONTRACT	CC-1
TECHNICAL SPECIFICATIONS (SEE EXHIBIT B1.2)	N/A

LIST OF EXHIBITS:

- **Exhibit A – Application and Certification of Payment**
- **Exhibit B1.1 – Johnson Center Scope Map**
- **Exhibit B1.2 – Johnson Center Roof Specifications**
- **Exhibit C1 – Johnson Center Existing Roof Details**

**COUNTY OF EL DORADO
CHIEF ADMINISTRATIVE OFFICE
FACILITIES DIVISION**

NOTICE TO BIDDERS

NOTICE IS HEREBY GIVEN by the County of El Dorado, State of California, that sealed bids for work in accordance with the Project Plans (Plans) and Contract Documents designated:

**JOHNSON CENTER ROOF REHABILITATION PROJECT
BID #20-968-053**

will be received by the Chief Administrative Office, Procurement & Contracts Division, at **330 FAIR LANE, PLACERVILLE, CALIFORNIA**, until **3:00 p.m. on June 2, 2020**, at which time and place bids will be publicly opened and read by the Chief Administrative Office, Procurement & Contracts Division.

No Bid may be withdrawn after the time established for receiving bids or before the award and execution of the Contract, unless the award is delayed for a period exceeding sixty (60) calendar days. Bids shall be executed in accordance with the instructions given and on the forms provided in the Contract Documents furnished by the County of El Dorado, Chief Administrative Office, Procurement & Contracts Division through the Quest Construction Data Network (Quest). The proposal including the Bidder's Bond shall be submitted in a sealed envelope clearly marked:

**“JOHNSON CENTER ROOF REHABILITATION PROJECT”
BID #20-968-053**

TO BE OPENED AT 3:00 P.M. ON JUNE 2, 2020

LOCATION/DESCRIPTION OF THE WORK: The project is located at Johnson Center, 1360 Johnson Boulevard, South Lake Tahoe, California in El Dorado County. The Work to be done as shown on the Plans, generally consists of, but is not limited to:

- A. The furnishing of all labor, materials, and equipment for the roof rehabilitation as shown or required per the contract documents. Bids are required for the entire work described herein.
- B. The contract time shall be **Forty-five (45) calendar days**.
- C. For bonding purposes the estimated project cost is **approximately \$210,000**.
- D. **A Pre-Bid Job Walk is scheduled for this project on May 12, 2020. BIDDERS OR THEIR REPRESENTATIVES SHALL MEET AT THE JOHNSON CENTER, 1360 JOHNSON BOULEVARD, SOUTH LAKE TAHOE, CALIFORNIA SHARPLY AT 10:00 A.M. ATTENDANCE AT THE PRE-BID JOB WALK IS MANDATORY. ONLY THE BIDS OF FIRMS WITH REPRESENTATIVES IN ATTENDANCE AND WHO HAVE SIGNED THE SIGN-IN SHEET WILL BE CONSIDERED FOR EVALUATION AND AWARD.** In order to limit the disruption to the conduct of business, the meeting date listed will be the only opportunity for bidders to visit the site. The Bidder's representative will be required to sign an attendance sheet and provide the name of the firm being represented. The County will post on the Quest website such Addenda as the County in its discretion considers necessary in response to questions arising and information presented at the Pre-Bid Job Walk. Oral statements shall not be relied upon and will not be binding or legally effective. Addenda and answers to questions deemed relevant and appropriate issued as a result of the Pre-Bid Job Walk shall constitute the sole and exclusive record and statement of the results of the Pre-Bid Job Walk.

PRE-BID COMMUNICATIONS & REQUESTS FOR INFORMATION (RFI): Questions will be accepted in writing only, through submission to the Quest website under the Quest Project #6904100 "Project Q&A", by email, or in hard copy, until **5:00 P.M. on May 22, 2020**. Pre-bid communications and RFI are to be emailed to: kady.leitner@edcgov.us with BID #20-968-053 – RFI as the subject, or in hard copy delivered to: County of El Dorado, Procurement & Contracts, 2850 Fairlane Court, Placerville, CA 95667, BID #20-968-053 – RFI. Answers to questions deemed relevant and appropriate will

be posted on Quest on or about May 27, 2020. Oral responses concerning the content of the Plans and Contract Documents shall not be relied upon and will not be binding or legally effective. Addenda will be uploaded in pdf format to Quest's website and Quest will issue an automatic email notification to all plan-holders that have acquired the Contract Documents digitally through Quest. The list of plan-holders will be available on Quest's website under "View Planholders".

OBTAINING OR INSPECTING CONTRACT DOCUMENTS: The contract documents may be viewed and/or downloaded from the Quest website at <http://www.questcdn.com>. Interested parties may also access the Quest website by clicking on the link next to the Project Name or entering the Quest project #6904100 on the Chief Administrative Office, Procurement and Contract's website at <http://edcapps.edcgov.us/contracts/invite.asp>.

Interested parties may view the Contract Documents on the Quest website at no charge. The digital Contract Documents may be downloaded for \$15.00 by inputting the Quest project #6904100 on the websites' Project Search page. Please contact Quest CDN.com at 925.233.1632 or info@questcdn.com for assistance with free membership, registration, downloading, and working with this digital project information.

To be included on the planholders list and receive notification of addenda, interested parties must download the Contract Documents from Quest. Those downloading the Contract Documents assume responsibility and risk for completeness of the downloaded Contract Documents.

Physical paper copies of the Contract Documents, including Plans, may be examined at the County of El Dorado, Chief Administrative Office, Procurement & Contract Division located at 2850 Fairlane Court, Placerville, California; however, the Chief Administrative Office will no longer issue paper copies of the Contract Documents to bidders.

CONTRACTORS LICENSE CLASSIFICATION: Bidders shall be properly licensed to perform the Work pursuant to the Contractors' State License Law (Business and Professions Code Section 7000 et seq.) and shall possess a **C-39 - Roofing Contractor License and be a Certified Tremco Approved Contractor at the time the bid is submitted**, and shall maintain a valid license and certification through completion and acceptance of the Work, including the guarantee and acceptance period. Failure of the successful Bidder to obtain proper adequate licensing at the time of contract award shall constitute a failure to execute the Contract and shall result in the forfeiture of the Bidder's security, and may result in legal penalties.

BUSINESS LICENSE: The County Business License Ordinance provides that it is unlawful for any person to furnish supplies or services, or transact any kind of business in the unincorporated territory of El Dorado County without possessing a County business license unless exempt under County Ordinance Code Section 5.08.070. The Bidder to whom an award is made shall comply with all of the requirements of the County Business License Ordinance, where applicable, prior to beginning work under this Contract and at all times during the term of this Contract.

REQUIRED LISTING OF PROPOSED SUBCONTRACTORS: Each Proposal shall have listed therein the name and address of each subcontractor, to whom the Bidder proposes to subcontract portions of the work in an amount in excess of 1/2 of one percent of its total bid in accordance with the Subletting and Subcontracting Fair Practices Act, commencing with Section 4100 of the Public Contract Code. The Bidder shall also describe in the Subcontractor Listing the work to be performed by each subcontractor listed. The work to be performed by the subcontractor shall be shown by listing the description of the work, and portion of the work to be performed by the subcontractor in the form of a percentage calculated by dividing the work to be performed by the subcontractor by the lump sum bid price. At the time the bids are submitted all listed subcontractors shall be properly licensed to perform their designated portion of the work. The Bidder's attention is invited to other provisions of the Act related to the imposition of penalties for a failure to observe its provisions by using unauthorized subcontractors or by making unauthorized substitutions.

CONTRACTOR REGISTRATION:

No contractor or subcontractor may be listed on a bid proposal for a public works project or awarded a contract for a public works project unless registered with the Department of Industrial Relations pursuant to Labor Code Sections 1771.1(a), 1725.5. Bids will not be accepted from unregistered contractors except as provided in section 1771.1.

NONDISCRIMINATION: Attention is directed to the following Notice that is required by Chapter 5 of Division 4 of Title 2, California Code of Regulations.

**NOTICE OF REQUIREMENT FOR NONDISCRIMINATION PROGRAM
(GOVERNMENT CODE SECTION 12990)**

PREVAILING WAGE REQUIREMENTS: In accordance with the provisions of California Labor Code Sections 1770 et seq., the general prevailing rate of wages in the county in which the Work is to be done has been determined by the Director of the California Department of Industrial Relations. These wage rates appear in the California Department of Transportation publication entitled General Prevailing Wage Rates. Interested parties can obtain the current wage information by submitting their requests to the Department of Industrial Relations, Division of Labor Statistics and Research, P.O. Box 420603, San Francisco CA 94142-0603, Telephone (415) 703-4708 or by referring to the website at <http://www.dir.ca.gov/dlsr/PWD>. The rates at the time of the bid advertisement date of a project will remain in effect for the life of the project in accordance with the California Code of Regulations, as modified and effective January 27, 1997.

Copies of the general prevailing rate of wages in the County in which the Work is to be done are also on file at the Chief Administrative Office, Facilities Division, and are available upon request.

In accordance with the provisions of Labor Code 1810, eight (8) hours of labor shall constitute a legal day's work upon all work done hereunder, and Contractor and any subcontractor employed under this Contract shall conform to and be bound by the provisions of Labor Code Sections 1810 through 1815.

BID SECURITY: A bid security shall be provided with each bid. Bid security shall be in an amount of not less than ten percent (10%) of the total amount bid for the Work and shall be cash, a certified check, or cashier's check drawn to the order of the County of El Dorado or a Bidder's Bond executed by a surety satisfactory to the County of El Dorado on the **form provided in the Proposal section of these Contract Documents**.

AWARD OF CONTRACT: The County of El Dorado reserves the right after opening bids to reject any or all bids, to waive any irregularity in a bid, or to make award to the lowest responsive, responsible Bidder(s) and reject all other bids, as it may best serve the interests of the County, see Proposal for additional information regarding contract award. The Purchasing Agent will recommend the bids for award by the Board of Supervisors.

As a condition of award, the successful Bidder will be required to submit bonds and evidence of insurance prior to execution of the Agreement by the County. Failure to meet this requirement shall constitute abandonment of the Bid by the Bidder and forfeiture of the Bidder's security. Award will then be made to the next lowest responsible Bidder.

BIDDERS PROTEST PROCEDURES:

The Chief Administrative Office, Procurement & Contracts Division, will notify all bidders in writing of its recommendation for award or rejection of bids, and the date and time on which the recommendation for award will be considered and acted upon by the Board of Supervisors ("Notice of Intent to Award"). All bidders may attend the Board of Supervisors meeting, address the Board, and be heard.

Within 5 working days from the date of the Notice of Intent to Award, the Bidder protesting the recommendation for award must submit a formal written protest to the Procurement & Contracts Division, stating in detail the basis and reason for the protest. The Bidder must provide facts to support the protest including any evidence Bidder wishes to be considered together with the law, rule, regulation, or criteria on which the protest is based. The Bidder may attend the Board of Supervisors meeting at which the recommendation and bid protest will be considered. If the Bidder is not in attendance at that time, the bid protest may be dismissed by the Board of Supervisors without further consideration of the merits and the decision of the Board of Supervisors on the bid protest shall be final.

PAYMENTS: Attention is directed to Article 5 –PAYMENT of the Contract.

RETAINAGE FROM PAYMENTS: Attention is directed to Article 20 – RETAINAGE of the Contract.

BY ORDER OF the Board of Supervisors, County of El Dorado, State of California.

Authorized by the Board of Supervisors on May 5, 2020 at Placerville, California.

Dated: 5/5/20

By: B-K Veerkamp

Chair, Board of Supervisors

Kim Dawson
Clerk of the Board of Supervisors

By: Jaretha Smith
Deputy Clerk

Dated: 5/5/20

*** END OF NOTICE TO BIDDERS ***

THESE INSTRUCTIONS SUPPLEMENT THE NOTICE TO BIDDERS, PROPOSAL, DRAFT AGREEMENT, AND CONDITIONS OF THE CONTRACT

**JOHNSON CENTER ROOF REHABILITATION PROJECT
BID #20-968-053**

INSTRUCTIONS TO BIDDERS

1. The County of El Dorado will receive sealed bids from Bidders as stipulated in the Notice to Bidders.
2. Bidders must submit bids only on forms provided in the Contract Documents downloaded from the Quest website and shall be accompanied by all documents and information required to be submitted by these Instructions to Bidders, the Notice to Bidders, and by law. Bids not submitted on the required forms will be deemed nonresponsive and shall not be considered.
3. Bidders must complete and submit the Proposal, Proposal Bid Price Schedule, Subcontractors Listing, Public Contract Code Section 10285.1 Statement, Public Contract Code Section 10162 Questionnaire, Non-Collusion Affidavit, Tremco Letter of Certification, Confidentiality of Information Provided, and page P-10, along with P-11 through P-13, as applicable. Bids submitted without the required documentation will be deemed nonresponsive and will not be considered.
4. Bidders must supply all information required by Contract Documents and specifications. Bids must be complete. The County reserves the right at its sole discretion to reject any bid as nonresponsive as a result of any error or omission in the bid.
5. Bidders may not modify Proposal Document or qualify their bids.
6. Submission of a bid signifies that the Bidder has done a careful examination of the Contract Documents and has a complete understanding of the nature, extent, and location of Work to be performed. Bidder must complete the tasks listed below in subsections "a - c" as a condition to bidding, and submission of bid shall constitute the Bidder's express representation to the County that Bidder has fully completed the following:
 - a. Bidder has downloaded all documents related to the project and takes responsibility for their completeness;
 - b. Bidder has attended the mandatory pre-bid job walk and has examined thoroughly and understands the nature and extent of the Contract Documents, Work, Site, locality, actual conditions, as-built conditions, and all local conditions and federal, state and local laws and regulations that in any manner may affect cost, progress, performance or furnishing of Work or which relate to any aspect of the means, methods, techniques, sequences or procedures of construction to be employed by Bidder and safety precautions and programs incident thereto;
 - c. Bidder has given the County representative during the bid period prompt written notice of all conflicts, errors, ambiguities or discrepancies that it has discovered in or among the Contract Documents and as built and actual conditions and the written resolution thereof by County is acceptable to Bidder.

7. The following represents the tentative schedule for this Project:

Bid Issuance	May 7, 2020
Mandatory Pre-Bid Job Walk	May 12, 2020 10:00 A.M.
Deadline for Final Questions	May 22, 2020 5:00 P.M.
Bid Submission Deadline	June 2, 2020 3:00 P.M.
Notice of Intent to Award	June 9, 2020
Contract Award by Board of Supervisors	June 23, 2020
Notice To Proceed	July 2020

8. The following documents are to be executed and submitted by the apparent low Bidder after bids have been opened and duly inspected, and the County transmits the Notice of Award package to the successful Bidder. Failure to properly and timely submit these documents entitles the County to determine that the Bidder has abandoned the contract, and the bidder’s security shall be forfeited to County.

Submit the following documents to Kady Leitner, Chief Administrative Office, Procurement and Contracts Division, 2850 Fairlane Court, Placerville, CA 95667 by 5:00 p.m. of the **TENTH** calendar day, following the date of the NOTICE OF AWARD OF CONTRACT letter. Execution of Contracts by the County depends upon approval of Insurance Certificates and Bonds, and associated contract documents.

- i. Contracts: The successful Bidder shall execute and submit the Agreements for the work associated with the Proposal Lump Sum Bid Price Schedule (See Draft Agreement). Submit two (2) originals of Agreement, each bearing an original signature.
- ii. County of El Dorado Performance Bond: To be executed by successful Bidder and surety each with notary acknowledgement.
- iii. County of El Dorado Payment Bond: To be executed by successful Bidder and surety each with notary acknowledgement.
- iv. Contractor’s Guarantee: execute and submit if not already provided with the bid submittal.
- v. Insurance certificates required by Contract Conditions and Article 8.
- vi. California Form 590 – Withholding Exemption and County Payee Data Record Form

*** END OF INSTRUCTIONS TO BIDDERS ***

**THE USE OF PENCIL OR CORRECTION FLUID OR TAPE IS NOT ACCEPTABLE.
BID DOCUMENTS COMPLETED IN PENCIL OR CONTAINING THE USE OF CORRECTION FLUID OR
TAPE WILL BE REJECTED.**

**ALL CHANGES MUST BE LINED OUT AND CORRECTIONS INSERTED ADJACENT TO THE CHANGE AND
INITIALED BY THE BIDDER'S AUTHORIZED REPRESENTATIVE**

PROPOSAL

(to be submitted with Bidder's Security)

**TO: CHIEF ADMINISTRATIVE OFFICE, PROCUREMENT & CONTRACTS DIVISION
COUNTY OF EL DORADO, STATE OF CALIFORNIA**

for the construction of

JOHNSON CENTER ROOF REHABILITATION PROJECT

BID #20-968-053

NAME OF BIDDER: _____

BUSINESS MAILING ADDRESS: _____

CITY, STATE, ZIP: _____

BUSINESS STREET ADDRESS: _____
(Please include even if P.O. Box used)

CITY, STATE, ZIP: _____

TELEPHONE NO: AREA CODE () _____

FAX NO: AREA CODE () _____

EMAIL ADDRESS _____

The work for which this Proposal is submitted is for the construction in accordance with these Contract Documents (including the payment of not less than the State general prevailing wage rates set forth herein), the Project Plans described below, including any addenda thereto, the Contract annexed hereto, and also in accordance with the Labor Surcharge and Equipment Rental Rates in effect on the date the work is accomplished, and in accordance with the General Prevailing Wage rates. The Project Plans and other Contract Documents for the work to be done are entitled:

JOHNSON CENTER ROOF REHABILITATION PROJECT

BID #20-968-053

Bids are to be submitted for the entire work. The work includes LUMP SUM BID. Failure to submit a bid for the entire work will result in the bid being deemed non-responsive.

The Bidder shall set forth a lump sum total for the BID, in clearly legible figures in the respective space provided for this purpose.

If the item total for the lump sum is unreadable or otherwise unclear, or is omitted, the bid may be deemed irregular.

Symbols such as commas and dollar signs will be ignored and have no mathematical significance in establishing lump sums. The written lump sum in numbers will be interpreted according to the number of digits and, if applicable, decimal placement. In the event of a discrepancy, the written lump sum in words will govern over the written lump sum in numbers.

The foregoing provisions for the resolution of specific irregularities cannot be so comprehensive as to cover every omission, inconsistency, error, or other irregularity which may occur in a bid. Any situation not specifically provided for will be determined in the discretion of the County of El Dorado, and that discretion will be exercised in the manner deemed by the County of El Dorado to best protect the public interest in the prompt and economical completion of the work. The decision of the County of El Dorado respecting the amount of a bid, or the existence or treatment of any irregularity in a bid, shall be final.

If this Proposal is accepted and the undersigned Bidder shall fail to enter into the Contract and furnish the two bonds in the sums required by the State Contract Act, with surety satisfaction to the County of El Dorado in accordance with the Special Provisions within ten (10) calendar days of the date of the letter notice from the County of El Dorado that the Contract has been awarded, the County of El Dorado may, at its option, determine that the Bidder has abandoned the Contract, and thereupon this Proposal and the acceptance thereof shall be null and void and the forfeiture of such security accompanying this Proposal shall operate and the same shall be the property of the County of El Dorado.

The undersigned Bidder acknowledges that a bid security must be submitted in amount of not less than ten (10) percent of the estimated project cost of \$210,000.00 (\$21,000.00).

The undersigned, as Bidder, declares under penalty of perjury under the laws of the State of California that the only persons or parties interested in this Proposal, as principals, are those named herein; that this Proposal is made without collusion with any other person, firm, or corporation; that it has carefully examined the location of the proposed work, the annexed proposed form of Contract, and the Plans therein referred to; and that it proposes, and agrees if this Proposal is accepted, that it will contract with the County of El Dorado, in the form of the copy of the Draft Agreement annexed hereto, to provide all necessary machinery, tools, apparatus, and other means of construction, and to do all the work and furnish all the materials specified in the Contract, in the manner and time therein prescribed, and according to the requirements of the County as therein set forth, and that it will take in full payment therefore the following item prices, to wit:

For the project site, Bidder's scope of work will include: cleaning & preparing existing roof in accordance with specifications; rehabilitation of existing roof through application of Tremco two-coat polyurethane elastomeric fluid-applied system; and application of slip-resistant surface & safety striping as shown in Scope Map. For additional scope of work information, see project specific exhibits, Exhibit B1.1 and B1.2. An abbreviated set of the original drawing, Exhibit C1, has also been provided. Should Bidder find relevant details missing from the original drawings, Bidder shall alert the County.

List of Exhibits:

- Exhibit A – Application and Certification of Payment
- Exhibit B1.1 – Johnson Center Scope Map
- Exhibit B1.2 – Johnson Center Roof Specifications

- Exhibit C1 – Johnson Center Existing Roof Details

**THE USE OF PENCIL OR CORRECTION FLUID OR TAPE IS NOT ACCEPTABLE.
BID DOCUMENTS COMPLETED IN PENCIL OR CONTAINING THE USE OF CORRECTION FLUID OR
TAPE WILL BE REJECTED.**

**ALL CHANGES MUST BE LINED OUT AND CORRECTIONS INSERTED ADJACENT TO THE CHANGE AND
INITIALED BY THE BIDDER'S AUTHORIZED REPRESENTATIVE**

**PROPOSAL BID PRICE SCHEDULE
JOHNSON CENTER ROOF REHABILITATION PROJECT
BID #20-968-053**

AWARD OF CONTRACT: Bid will be awarded on the basis of the lowest responsive, responsible bidder based upon the total of the LUMP SUM bid and meeting all other requirements.

Lump Sum Bid Amount: \$ _____

NOTICE: Bidder's failure to execute the questionnaire and statements contained in this Bid as required by applicable laws and regulations, or the determinations by the County of El Dorado based upon those questionnaires and statements, may prohibit award of the subject Contract to the Bidder.

**THE USE OF PENCIL OR CORRECTION FLUID OR TAPE IS NOT ACCEPTABLE.
BID DOCUMENTS COMPLETED IN PENCIL OR CONTAINING THE USE OF CORRECTION FLUID OR
TAPE WILL BE REJECTED.**

**ALL CHANGES MUST BE LINED OUT AND CORRECTIONS INSERTED ADJACENT TO THE CHANGE AND
INITIALED BY THE BIDDER'S AUTHORIZED REPRESENTATIVE**

SUBCONTRACTORS LISTING

The Bidder shall list the name, address, and license number of each subcontractor to whom the Bidder proposes to subcontract portions of the work in an amount in excess of one-half of 1% of the total bid, in accordance with the Subletting and Subcontracting Fair Practices Act, commencing with Section 4100 of the Public Contract Code and as required by the provisions in "Required Listing of Proposed Subcontractors" in the Notice to Bidders. **The Bidder shall list the description of work and express the percentage of work to be performed by each subcontractor as subcontracted amount divided by LUMP SUM BID amount.**

Name	Location of Business	License No.	Description of Work and Percentage of Work Subcontracted

**THE USE OF PENCIL OR CORRECTION FLUID OR TAPE IS NOT ACCEPTABLE.
BID DOCUMENTS COMPLETED IN PENCIL OR CONTAINING THE USE OF CORRECTION FLUID OR
TAPE WILL BE REJECTED.**

**ALL CHANGES MUST BE LINED OUT AND CORRECTIONS INSERTED ADJACENT TO THE CHANGE AND
INITIALED BY THE BIDDER'S AUTHORIZED REPRESENTATIVE**

PUBLIC CONTRACT CODE SECTION 10285.1 STATEMENT

In accordance with Public Contract Code Section 10285.1 (Chapter 376, Stats. 1985), the Bidder hereby declares under penalty of perjury under the laws of the State of California that the Bidder has _____, has not _____ been convicted within the preceding three years of any offenses referred to in that Section, including any charge of fraud, bribery, collusion, conspiracy, or any other act in violation of any state or Federal antitrust law in connection with the bidding upon, award of, or performance of, any public works contract, as defined in Public Contract Code Section 1101, with any public entity, as defined in Public Contract Code Section 1100. The term "Bidder" is understood to include any partner, member, officer, director, responsible managing officer, or responsible managing employee thereof, as referred to in Section 10285.1.

NOTE: The Bidder must place a check mark after "has" or "has not" in one of the blank spaces provided.

The above Statement is part of the Proposal. Signing this Proposal on the signature portion thereof shall also constitute signature of this Statement.

Bidders are cautioned that making a false certification may subject the certifier to criminal prosecution.

Signature: _____

Date: _____

Name: _____

Title: _____

Firm: _____

**THE USE OF PENCIL OR CORRECTION FLUID OR TAPE IS NOT ACCEPTABLE.
BID DOCUMENTS COMPLETED IN PENCIL OR CONTAINING THE USE OF CORRECTION FLUID OR
TAPE WILL BE REJECTED.**

**ALL CHANGES MUST BE LINED OUT AND CORRECTIONS INSERTED ADJACENT TO THE CHANGE AND
INITIALED BY THE BIDDER'S AUTHORIZED REPRESENTATIVE**

PUBLIC CONTRACT CODE SECTION 10162 QUESTIONNAIRE

In accordance with Public Contract Code Section 10162, the Bidder shall complete, under penalty of perjury under the laws of the State of California, the following questionnaire:

Has the Bidder, any officer of the Bidder, or any employee of the Bidder who has a proprietary interest in the Bidder, ever been disqualified, removed, or otherwise prevented from bidding on, or completing a federal, state, or local government project because of a violation of law or a safety regulation?

Yes: _____ No: _____

If the answer is yes, explain the circumstances in the following space:

PUBLIC CONTRACT CODE SECTION 10232 STATEMENT

In accordance with Public Contract Code Section 10232, the Bidder hereby states under penalty of perjury under the laws of the State of California, that no more than one final unappealable finding of contempt of court by a Federal Court has been issued against the Bidder within the immediate preceding two year period because of the Bidder's failure to comply with an order of a Federal Court which orders the Bidder to comply with an order of the National Labor Relations Board.

NOTE:

The above Questionnaire and Statement are part of the Proposal. Signing this Proposal on the signature portion thereof shall also constitute signature of this Questionnaire and Statement.

Bidders are cautioned that making a false certification may subject the certifier to criminal prosecution.

NONCOLLUSION AFFIDAVIT
(Title 23 United States Code Section 112 and
Public Contract Code Section 7106)

In accordance with Title 23 United States Code, Section 112 and Public Contract Code Section 7106, the Bidder declares that the bid is not made in the interest of, or on behalf of, any undisclosed person, partnership, company, association, organization, or corporation; that the bid is genuine and not collusive or sham; that the Bidder has not directly or indirectly induced or solicited any other Bidder to put in false or sham bid, and has not directly or indirectly colluded, conspired, connived, or agreed with any Bidder or anyone else to put in a sham bid, or that anyone shall refrain from bidding; that the Bidder has not in any manner, directly or indirectly, sought by agreement, communication, or conference with anyone to fix the bid price of the Bidder or any other Bidder, or to fix any overhead, profit, or cost element of the bid price, or of that of any other Bidder, or to secure any advantage against the public body awarding the Contract of anyone interested in the proposed Contract; that all statements contained in the bid are true; and, further, that the Bidder has not, directly or indirectly, submitted his or her bid price or any breakdown thereof, or the contents thereof, or divulged information or data relative thereto, or paid, and will not pay, any fee to any corporation, partnership, company, association, organization, bid depository, or to any member or agent thereof to effectuate a collusive or sham bid.

NOTE:

The above Noncollusion Affidavit is part of the Proposal. Signing this Proposal on the signature portion thereof shall also constitute signature of this Noncollusion Affidavit.

Bidders are cautioned that making a false certification may subject the certifier to criminal prosecution.

Signature: _____

Date: _____

Name: _____

Title: _____

Firm: _____

TREMCO LETTER OF CERTIFICATION

CONFIDENTIALITY OF INFORMATION PROVIDED

Contractor shall maintain the confidentiality and privileged nature of all records. Upon completion of all Services, ownership and title to all reports, documents, plans, maps, specifications, estimates, compilations and any and all other materials or data given to Contractor as part of the Services requested shall be returned to the County.

Signature: _____

Date: _____

Name: _____

Title: _____

Firm: _____

Accompanying this proposal is _____

(NOTICE: INSERT THE WORDS "CASH (\$ ____),"CASHIER'S CHECKS," "CERTIFIED CHECKS," OR "BIDDERS BONDS," AS THE CASE MAY BE)

in amount equal to at least ten percent of the total of the estimated project cost of \$210,000.00 (\$21,000.00).

The names of all persons interested in the forgoing Proposal as principals are as follows:

IMPORTANT NOTICE: If the Bidder or other interested person is a corporation, state legal name of corporation and place of incorporation, also names of the president, secretary, treasurer, and executive officer thereof; if a partnership, state name of partnership, also names of all individual partners; if Bidder or other interested person is an individual, state first and last names in full.

Licensed in accordance with an act providing for the registration of Contractors,

License No. _____ Classification(s) _____

A copy of the afore-referenced license must be attached hereto.

ADDENDA: This Proposal is submitted with respect to the changes to the Contract included in addenda number(s)

(Fill in addenda numbers if addenda have been received and insert, in this Proposal, any Proposal Pay Items and Bid Price Schedules that were received as part of the addenda)

By my signature on this Proposal I certify, under penalty of perjury under the laws of the State of California, that the foregoing questionnaire and statements of Public Contract Code Sections 10162, 10232, and 10285.1 are true and correct and that I have complied with the requirements of Section 8103 of the Fair Employment and Housing Commission Regulations (Chapter 5 of Division 4 of Title 2 of the California Code of Regulations). By my signature on this Proposal I further certify, under penalty of perjury under the laws of the State of California and the United States of America that the Noncollusion Affidavit required by Title 23 United States Code, Section 112 and Public Contract Code Section 7106 is true and correct.

The person or persons executing this Proposal on behalf of a corporation or partnership shall be prepared to demonstrate by resolution, article, or otherwise, that such person is or that such persons are appropriately authorized to act in these regards for such corporation or partnership. Such authority shall be demonstrated to the satisfaction of the County of El Dorado.

If the signature is by an agent other than an officer of a corporation or a member of a partnership, a power of attorney authorizing said act by the agent on behalf of his principal shall be submitted with the bid forms; otherwise, the bid may be disregarded as irregular and unauthorized.

The Bidder's execution on the signature portion of this Proposal shall constitute an endorsement and execution of those affidavits, declarations and certifications which are part of this Proposal.

Executed this _____ day of _____, 20__

at: _____ County, State of _____

Date: _____

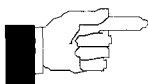

SIGN HERE: _____

Name and Title of Bidder: _____

Name of Firm: _____

END OF PROPOSAL

COUNTY OF EL DORADO

BIDDER'S BOND

this form MUST be used

KNOW ALL PEOPLE BY THESE PRESENTS, THAT WE _____
_____, as **PRINCIPAL**, and

as Surety are held and firmly bound unto the County of El Dorado (Obligee), in the penal sum of **TEN (10) PERCENT OF THE AMOUNT OF THE TOTAL LUMP SUM BID PRICE** of the Principal above named, submitted by said Principal to the Obligee for the work described below, for the payment of which sum in lawful money of the United States, well and truly to be made to the Obligee, we the Principal and Surety bind ourselves, our heirs, executors, administrators and successors, jointly and severally, firmly by these presents. In no case shall the liability of the Surety hereunder exceed the sum of

TEN PERCENT (10%) OF THE TOTAL OF THE ESTIMATED PROJECT COST OF \$210,000.00 (\$21,000.00)

THE CONDITION OF THIS OBLIGATION IS SUCH, THAT:

WHEREAS, the Principal has submitted the above-mentioned Bid to the Obligee, as aforesaid, for certain construction specifically described as follows, for which bids are to be opened at Placerville, El Dorado County, California, for the construction of the:

JOHNSON CENTER ROOF REHABILITATION PROJECT
BID #20-968-053

NOW, THEREFORE, if the aforesaid Principal is awarded the Contract and, within the time and manner required under the Contract Documents, after the prescribed forms are presented to it for signature, enters into a written contract, in the prescribed form, in accordance with the Bid, and files two bonds with the County of El Dorado, one to guarantee faithful performance and the other to guarantee payment for labor and materials, as required by law, then this obligation shall be null and void; otherwise, it shall remain in full force and virtue.

In the event suit is brought upon this bond by the Obligee and judgment is recovered, the Surety shall pay all costs incurred by the Obligee in such suit, including a reasonable attorney's fee to be fixed by the Court.

IN WITNESS WHEREOF, we have set our hands and seals on this _____ day of _____ 20____

(seal) _____
Principal

(seal) _____
Surety

Address: _____

(NOTE: Signature of those executing for the Surety shall be properly acknowledged, and accompanied by a Certificate of Acknowledgment.)

PRINCIPAL

A notary public or other officer completing this certificate verifies only the identity of the individual who signed the document to which this certificate is attached, and not the truthfulness, accuracy, or validity of that document.

ACKNOWLEDGMENT

State of California

County of _____

On before me, _____,
(here insert name and title of the officer)

personally appeared _____

_____ ,

who proved to me on the basis of satisfactory evidence to be the person(s) whose name(s) is/are subscribed to the within instrument and acknowledged to me that he/she/they executed the same in his/her/their authorized capacity(ies), and that by his/her/their signature(s) on the instrument the person(s), or the entity upon behalf of which the person(s) acted, executed the instrument.

I certify under PENALTY OF PERJURY under the laws of the State of California that the foregoing paragraph is true and correct

WITNESS my hand and official seal.

Signature _____

(Seal)

SURETY

A notary public or other officer completing this certificate verifies only the identity of the individual who signed the document to which this certificate is attached, and not the truthfulness, accuracy, or validity of that document.

ACKNOWLEDGMENT

State of California

County of _____

On before me, _____,
(here insert name and title of the officer)

personally appeared _____

who proved to me on the basis of satisfactory evidence to be the person(s) whose name(s) is/are subscribed to the within instrument and acknowledged to me that he/she/they executed the same in his/her/their authorized capacity(ies), and that by his/her/their signature(s) on the instrument the person(s), or the entity upon behalf of which the person(s) acted, executed the instrument.

I certify under PENALTY OF PERJURY under the laws of the State of California that the foregoing paragraph is true and correct.

WITNESS my hand and official seal.

Signature _____

(Seal)

County of El Dorado

BID #20-968-053

JOHNSON CENTER ROOF REHABILITATION PROJECT

THIS AGREEMENT ("Agreement") approved by the County of El Dorado Board of Supervisors, this _____ day of _____, in the year of 20__, made and concluded, in duplicate, between the COUNTY OF EL DORADO, a political subdivision of the State of California, by the Chief Administrative Office, Facilities Division thereof, the party of the first part hereinafter called "County," and _____ (Contractor) _____ party of the second part hereinafter called "Contractor."

RECITALS

WHEREAS, County has caused the above-captioned project to be let to formal bidding process; and

WHEREAS, Contractor has duly submitted a bid response for the captioned project upon which County has awarded this Contract.

NOW, THEREFORE, the parties hereto have mutually covenanted and agreed, and by these presents do covenant and agree, each with the other, as follows:

Article 1. THE WORK

The improvement contemplated in the performance of this Contract is an improvement over which the County of El Dorado shall exercise general supervision. The County therefore, shall have the right, but not the duty to assume full and direct control over this Contract whenever the County at its sole discretion, shall determine that its responsibility is so required.

The Contractor shall complete the Work as specified or indicated under the County's Contract Documents entitled:

JOHNSON CENTER ROOF REHABILITATION PROJECT

The project is located at the Johnson Center, 1360 Johnson Boulevard, South Lake Tahoe, California in El Dorado County. The Work to be done as described in the Technical Specifications section and as shown on the Plans, generally consists of, but is not limited to: furnishing of all labor, materials, and equipment for the roof rehabilitation. The Work shall include:

Cleaning & preparing existing roof in accordance with specifications; rehabilitation of existing roof through application of Tremco two-coat polyurethane elastomeric fluid-applied system; and application of slip-resistant surface & safety striping as shown in Scope Map. For additional scope of work information, see project specific exhibits. An abbreviated set of the original drawings, Exhibit C1, has also been provided. Should Bidder find relevant details missing from the original drawings, Bidder shall alert the County.

- 1) Johnson Center – Rehabilitation of Modified Bituminous Membrane Roofing: Exhibits B1.1 & B1.2

Article 2. CONTRACT DOCUMENTS

The Contract Documents consist of: the Notice to Bidders; the bid forms which include the accepted Proposal, Proposal Bid Price Schedule, Subcontractors Listing, Section 10285.1 Statement, Section 10162 Questionnaire, Section 10232 Statement, and the Noncollusion Affidavit; the Contract which includes this Agreement with all Exhibits thereto, the Performance Bond and Payment Bond; Conditions of the Contract; the drawings, specification and diagrams, listed and identified as the Project

Plans; all Addenda incorporated in those documents before their execution, all Contract Change Orders, Architect's Supplemental Instructions, and Construction Change Directives issued in accordance with the Contract Documents which may be delivered or issued after the Effective Date of this Agreement and are not attached hereto; the prevailing Labor Surcharge And Equipment Rental Rates (when required) as determined by the Department of Industrial Relations to be in effect on the date the Work is accomplished; all the obligations of County and of Contractor which are fully set forth and described therein; and all Contract Documents which are hereby specifically referred to and by such reference made a part hereof. All Contract Documents are intended to cooperate so that any work called for in one and not mentioned in the other is to be executed the same as if mentioned in all Contract Documents. Contractor agrees to perform all of its promises, covenants, and conditions set forth in the Contract Documents, and to abide by and perform all terms and conditions set forth therein. In case of conflict between this Agreement and any other contract document, this Agreement shall take precedence.

Article 3. CONTRACT PRICE

As compensation agreed upon for said Work, County shall pay or cause to be paid to Contractor, in full, and for the full contract price and compensation for said completion of the Work, including without limitation, all bonds and insurance, THE NOT TO EXCEED SUM OF (insert dollar amount in words) DOLLARS \$(insert dollar amount in numbers)) which sum constitutes the Contract Price for the complete Project (the "Contract Price").

Article 4. COMMENCEMENT AND COMPLETION

The Work to be performed under this Contract shall commence on the date specified in the Notice to Proceed issued by County. The work shall be diligently prosecuted to completion within **forty-five (45) calendar days** commencing from the date shown on the Contractor Notice to Proceed.

County and Contractor recognize that time is of the essence of the Agreement and that County will suffer loss if the Work is not completed within the time specified in the above paragraph, plus any extensions thereof allowed in accordance with Article 4.3.5 of the Conditions of the Contract. The parties also recognize delays, expense, and difficulties involved with proving in a legal proceeding the actual loss suffered by County if the Work is not completed on time. Accordingly, instead of requiring any such proof, County and Contractor agree that as liquidated damages for delay (but not as a penalty), Contractor shall pay County the sum of **ONE THOUSAND DOLLARS (\$1000.00)** for each and every calendar day, as liquidated damages and not as a penalty, for each and every calendar day's delay in finishing the Work in excess of the contract time prescribed herein; and Contractor agrees that County may deduct the amount thereof from any monies due or that may become due Contractor under this contract.

Article 5. PAYMENT

Payment shall be made to Contractor as follows:

Progress payments are to be made monthly based on the percentage of completion method reached by the Contractor and invoiced using Exhibit A, marked "Application and Certificate for Payment" incorporated herein and made by reference a part hereof.

Retention of 5% of the total Contract price will be held until the work is 50% complete, and thereafter at the option of County. Payment by County as herein provided shall not be construed as an absolute acceptance of defects in the work or improper materials.

Article 6. INDEMNITY

To the fullest extent allowed by law, Contractor shall defend, indemnify, and hold the County and its officers, directors, and employees harmless against and from any and all claims, suits, losses, damages, and liability for damages, including attorney's fees and other costs of defense brought for or on account of injuries to or death of any person, including but not limited to, workers and the public, or on account of injuries to or death of County employees, or damage to property, or any economic, consequential or special damages which are claimed or which shall in any way arise out of or be connected with

Contractor's services, operations or performance hereunder, regardless of the existence or degree of fault or negligence on the part of the County, the Contractor, subcontractors or employees of any of these, except for the active, or sole negligence of the County, its officers and employees, or where expressly prescribed by statute.

The duty to indemnify and hold harmless the County specifically includes the duties to defend set forth in Section 2778 of the Civil Code. The insurance obligations of the Contractor are separate, independent obligations under the Contract Documents, and the provisions of this defense and indemnity are not intended to modify nor should they be construed as modifying or in any way limiting the insurance obligations set forth in the Contract Documents.

Article 7. GUARANTEES

Contractor shall repair or replace any or all work provided hereunder which is defective due to faulty materials, poor workmanship, or defective equipment at no expense to County, ordinary wear or tear and unusual abuse or neglect excepted, during the term of the Contract and for a period of one (1) year after Notice of Acceptance. Contractor shall be required to repair or replace any and all adjacent facilities or areas which have been damaged or displaced due to Contractor work performed under this Agreement at no expense to County during the term of this Contract and for a period of one (1) year after Notice of Acceptance.

If a warranty or guarantee exceeding one (1) year is provided by the supplier or manufacturer of any equipment or materials used in this Project, or if a warranty or guarantee exceeding one (1) year is required elsewhere in these Contract Documents, then the guarantee for such equipment or materials shall be extended for such term. Contractor expressly agrees to act as co-guarantor of such equipment and materials, and Contractor shall supply County with all warranty and guaranty documents relative to equipment and materials incorporated in the job and guaranteed by its suppliers or manufacturers.

The parties agree that this guarantee and the rights and obligations accruing therefrom shall be in addition to, and not by way of limitation in any manner whatsoever to, the rights, obligations, warranties or remedies otherwise provided for by law.

In the event of Contractor's failure to comply with the above mentioned conditions within ten (10) calendar days after being notified in writing by County, Contractor hereby authorizes County to proceed to have said defects repaired and made good at Contractor's expense, and Contractor will honor and pay all costs and charges therefore upon written demand.

Article 8. NOTICE

Any notice or other correspondence required to be given under this Agreement by either party to the other may be affected by personal delivery in writing or by mail, postage prepaid. Notices personally delivered during normal business hours shall be deemed received on the actual date of delivery; mailed notices shall be deemed received one (1) day after affixed postmark. Notices and correspondence to County shall be in duplicate and shall be delivered to it as follows:

To County:

County of El Dorado
Chief Administrative Office
3000 Fairlane Court, Suite One

Attn.: Russ Fackrell
Facilities Manager

Notices and correspondence to Contractor shall be delivered when personally delivered to, or if mailed, addressed to Contractor at:

Contractor's Business Name
Street Address
City, State Zip

Attn.: Name of Notices Recipient
Title of Notices Recipient

Either party may change its address for notices by giving written notice pursuant to this Article.

Article 9. VENUE

The Contract Documents and all provisions thereto shall be governed by the laws of the State of California. Any litigation arising out of this Contract shall be brought in El Dorado County.

Article 10. PERFORMANCE BOND

As a part of the execution of this Contract, Contractor shall furnish a bond of a surety company authorized to do business in the State of California, conditioned upon the faithful performance of all covenants and stipulations under this Contract. The amount of this bond shall be one hundred percent (100%) of the total Contract Price and shall be executed upon the form provided by County.

Article 11. PAYMENT BOND

As a part of the execution of this Contract, Contractor shall furnish a bond of a surety company authorized to do business in the State of California, conditioned upon the payment in full of all claims for labor and materials in accordance with the provisions of the law of the State of California. The amount of this bond shall be one hundred percent (100%) of the total Contract Price and shall be executed upon the form provided by County.

Article 12. NOTIFICATION OF SURETY COMPANY

The surety company shall familiarize itself with all of the conditions and provisions of this Contract, and shall waive the right of special notification of any change or modifications of this Contract or extension of time, or of decreased or increased work, or of the cancellation of the Contract, or of any other act or acts by County or its authorized agents, under the terms of this Contract; and failure to so notify the aforesaid surety company of changes shall in no way relieve the surety company of its obligation under this Contract.

Article 13. ASSIGNMENT OF ANTITRUST ACTIONS

In entering into a public works contract or a subcontract to supply goods, services, or materials pursuant to a public works contract, the Contractor offers and agrees and will require all of its subcontractors and suppliers to agree to assign to the awarding body all rights, title, and interest in and to all causes of action it may have under Section 4 of the Clayton Act (15 U.S.C. Sec. 15) or under the Cartwright Act (Chapter 2 (commencing with Section 16700) of Part 2 of Division 7 of the Business and Professions Code), arising from purchases of goods, services, or materials pursuant to the public works contract or the subcontract. This assignment shall be made and become effective at the time the awarding body tenders final payment to Contractor, without further acknowledgment by the parties.

If an awarding body or public purchasing body receives, either through judgment or settlement, a monetary recovery for a cause of action assigned under Government Code Sections 4550-4554, the assignor shall be entitled to receive reimbursement for actual legal costs incurred and may, upon demand, recover from the public body any portion of the recovery, including treble damages, attributable to overcharges that were paid by the assignor but were not paid by the public body as part of the bid price, less the expenses incurred in obtaining that portion of the recovery. Upon demand in writing by the assignor, the assignee shall, within one year from such demand, reassign the cause of action assigned under Government Code Sections 4550-4554 if the assignor has been or may have been injured by the violation of law for which the cause of action arose and (a) the assignee has not been injured thereby, or (b) the assignee declines to file a court action for the cause of action.

Article 14. TERMINATION BY COUNTY FOR CONVENIENCE

County reserves the right to terminate the Contract at any time upon determination by County's representative that termination of the Contract is in the best interest of County. County shall issue Contractor a written notice specifying that the Contract is to be terminated.

Upon receipt of said written notice, Contractor shall stop all work under the Contract except: (1) work specifically directed to be completed prior to termination, (2) work the Inspector deems necessary to secure the project for termination, (3) removal of equipment and plant from the site of the Work, (4) action that is necessary to protect materials from damage, (5) disposal of materials not yet used in the Work as directed by County, and (6) clean up of the site.

If the Contract is terminated for County's convenience as provided herein, all finished or unfinished work and materials previously paid for shall, at the option of County, become its property. Contractor shall be paid an amount which reflects costs incurred for work provided to the date of notification of termination. In addition, Contractor shall be paid the reasonable cost, as solely judged by County, and without profit, for all work performed to secure the project for termination.

Article 15. TERMINATION BY COUNTY FOR CAUSE

If Contractor is adjudged as bankrupt or insolvent, or makes a general assignment for the benefit of its creditors or if a trustee or receiver is appointed for Contractor or for any of its property, or if Contractor files a petition to take advantage of any debtor's act, or to reorganize under the bankruptcy or applicable laws, or on more than one occasion fails to supply sufficient skilled workmen or suitable material or equipment, or on more than one occasion fails to make prompt payments to subcontractors for labor, materials, or equipment, or disregards the authority of the County's representative, or the Engineer, if one is appointed, or otherwise violates any provision of the Contract Documents, then County may, without prejudice to any other right or remedy and after giving Contractor and its Surety a minimum of ten (10) calendar days from delivery of a written termination notice, terminate the services of Contractor and take equipment and machinery thereon owned by Contractor and finish the Work by whatever method County may deem expedient. In such case, Contractor shall not be entitled to receive any further payment until the Work is finished.

Without prejudice to other rights or remedies County may have, if Contractor fails to begin delivery of materials and equipment, to commence Work within the time specified, to maintain the rate of delivery of material, to execute the Work in the manner and at such locations as specified, or fails to maintain a work program which will ensure County's interest, or, if Contractor is not carrying out the intent of the Contract, an Inspector's written notice may be served upon Contractor and the Surety on its faithful performance bond demanding satisfactory compliance with the Contract. If Contractor or its Surety does not comply with such notice within five (5) calendar days after receiving it, or after starting to comply, fails to continue, County may exclude it from the premises and take possession of all material and equipment, and complete the Work by County's own forces, by letting the unfinished Work to another Contractor, or by a combination of such methods.

Where Contractor's services have been so terminated by County, said termination shall not affect any right of County against Contractor then existing or which may thereafter accrue. Any retention or payment of monies by County due Contractor will not release Contractor from compliance with the Contract Documents.

If the unpaid balance of the Contract price exceeds the direct and indirect costs of completing the Work, including compensation for additional professional services, such excess shall be paid to Contractor. If the sums under the Contract are insufficient for completion, Contractor or Surety shall pay to County within five (5) calendar days after the completion, all costs in excess of the Contract price. In any event, the cost of completing the Work shall be charged against Contractor and its Surety and may be deducted from any money due or becoming due from County.

The provisions of this Article shall be in addition to all other rights and remedies available to County under law.

If after notice of termination, it is determined for any reason that Contractor was not in default, the rights and obligations of the parties shall be the same as if the notice of termination had not been issued. The Contract shall be equitably adjusted to compensate for such termination.

Article 16. SUCCESSORS AND ASSIGNS

This Agreement shall bind and inure to the heirs, devisees, assignees, and successors in interest of Contractor and to the successors in interest of County in the same manner as if such parties had been expressly named herein.

Article 17. REPORTING ACCIDENTS

Contractor shall prepare and submit (within 24 hours of such incidents) reports of accidents at the site and anywhere else the work is in progress in which bodily injury is sustained or property loss in excess of Five Hundred Dollars (\$500.00) occurs.

Article 18. WORKERS' COMPENSATION CERTIFICATION

Contractor shall comply with Labor Code Sections 3700 et seq., requiring it to obtain Workers' Compensation Insurance, and sign a certificate of knowledge thereof.

CERTIFICATE OF KNOWLEDGE - LABOR CODE SECTION 3700

I am aware of the provisions of Section 3700 of the Labor Code, which require every employer to be insured against liability for workers' compensation or to undertake self-insurance in accordance with the provisions of that Code, and I will comply with such provisions before commencing the performance of work of this Contract.

Signed: _____ Date: _____

Article 19. WARRANTY

Contractor warrants to County that materials and equipment furnished for the Work will be of good quality and new, unless otherwise required or permitted under the Contract Documents, that the Work will be free from defects or flaws and is of the highest quality of workmanship and that the Work will conform with the requirements herein. Work not conforming to these requirements, including substitutions not properly approved and authorized, shall be considered defective.

Article 20. RETAINAGE

The retainage from payments is set forth in Section 6.4 "WITHHOLDINGS FROM PAYMENTS" of the Conditions of the Contract. Contractor may elect to receive one hundred percent (100%) of payments due as set forth in the Contract Documents, without retention, by depositing securities of equivalent value with County, in accordance with, and as set forth in Section 22300 of the Public Contract Code. Securities eligible for deposit hereunder shall be limited to those listed in Section 16430 of the Government Code, or bank or savings and loan certificates of deposit.

Article 21. RESOLUTION OF CLAIMS

Contractor's attention is directed to California Public Contract Code Section 9204, which describes procedures for the resolution of claims on public works projects. Among other things, Section 9204 requires the claimant to furnish reasonable documentation to support a claim, requires the public entity to respond to the claim within forty-five (45) days of receipt of the claim, and allows for the claimant to demand an informal meet and confer conference for settlement of the issues in dispute. For any portion of a claim that remains in dispute, Section 9204 requires submission of the claim to nonbinding mediation. Additionally, Section 9204 requires the public entity to make any payment due on an undisputed portion of the claim within sixty (60) days of the public entity's written response and to pay interest at the rate of seven percent (7%) per annum on any amounts not paid in a timely manner. The provisions of Sections 20104 et seq. also apply to the resolution of claims under this Contract to the extent those sections are not in conflict with Section 9204.

Article 22. PREVAILING WAGE REQUIREMENTS

In accordance with the provisions of California Labor Code Sections 1770 et seq., the general prevailing rate of wages in the county in which the Work is to be done has been determined by the Director of the California Department of Industrial Relations. Interested parties can obtain the current wage information by submitting their requests to the Department of Industrial Relations, Division of Labor Statistics and Research, P.O. Box 420603, San Francisco, CA 94142-0603, Telephone (415) 703-4708 or by referring to the website at <http://www.dir.ca.gov/dlsr/PWD>. The rates at the time of the bid

advertisement date of a project will remain in effect for the life of the project in accordance with the California Code of Regulations, as modified and effective January 27, 1997.

Copies of the general prevailing rate of wages in the county in which the Work is to be done are also on file at the Chief Administrative Office, Facilities Division, and are available upon request.

In accordance with the provisions of Labor Code 1810, eight (8) hours of labor shall constitute a legal day's work upon all work done hereunder, and Contractor and any subcontractor employed under this Contract shall conform to and be bound by the provisions of Labor Code Sections 1810 through 1815.

Article 23. CONTRACTOR REGISTRATION

In accordance with California Labor Code Section 1771.1, a contractor or subcontractor shall not be qualified to bid on, be listed in a bid proposal, subject to the requirements of Section 4104 of the Public Contract Code, or engage in the performance of any contract for public work, as defined in this chapter, unless currently registered and qualified to perform public work pursuant to Section 1725.5. It is not a violation of this section for an unregistered contractor to submit a bid that is authorized by Section 7029.1 of the Business and Professions Code or by Section 10164 or 20103.5 of the Public Contract Code, provided the contractor is registered to perform public work pursuant to Section 1725.5 at the time the contract is awarded.

The contractor must post job site notices as prescribed by regulation 8 California Code of Regulations Section 16451. All contractors and subcontractors must furnish electronic certified payroll records directly to the Department of Industrial Relations (DIR). The work is subject to compliance monitoring and enforcement by the DIR.

Article 24. AUDIT BY CALIFORNIA STATE AUDITOR

Audit by California State Auditor: Contractor acknowledges that if total compensation under this agreement is greater than \$10,000.00, this Agreement is subject to examination and audit by the California State Auditor for a period of three (3) years, or for any longer period required by law, after final payment under this Agreement, pursuant to California Government Code §8546.7. In order to facilitate these potential examinations and audits, Contractor shall maintain, for a period of at least three (3) years, or for any longer period required by law, after final payment under the contract, all books, records and documentation necessary to demonstrate performance under the Agreement.

Article 25. TAXES

Contractor certifies that as of today's date, it is not in default on any unsecured property taxes or other taxes or fees owed by Contractor to County. Contractor agrees that it shall not default on any obligations to County during the term of this Agreement.

Article 26. CHILD SUPPORT COMPLIANCE ACT

For any Agreement in excess of \$100,000.00, the Contractor acknowledges in accordance with Public Contract Code 7110, that:

- a) The Contractor recognizes the importance of child and family support obligations and shall fully comply with all applicable state and federal laws relating to child and family support enforcement, including, but not limited to, disclosure of information and compliance with earnings assignment orders, as provided in Chapter 8 (commencing with section 5200) of Part 5 of Division 9 of the Family Code; and
- b) The Contractor, to the best of its knowledge is fully complying with the earnings assignment orders of all employees and is providing the names of all new employees to the New Hire Registry maintained by the California Employment Development Department.

Article 27. LICENSES

Contractor warrants and represents that it holds a valid California license pursuant to the Contractors' State License Law (Business and Professions Code Sections 7000, et seq.), that its license is in good standing and that it possesses a Class C-39 Roofing Contractor's License as required by the categories and type of the Work. Copies of Contractor's State Contractors' license must be provided with this Agreement.

In addition, Contractor hereby represents and warrants that Contractor and any of its subcontractors employed under this Agreement has all the applicable licenses, permits, and certifications that are legally required for Contractor and its subcontractors to practice its profession or provide the services or work contemplated under this Agreement in the State of California. Contractor and its subcontractors shall obtain or maintain said applicable licenses, permits, or certificates in good standing throughout the term of this Agreement

Article 28. BUSINESS LICENSE

The County Business License Ordinance provides that it is unlawful for any person to furnish supplies or services, or transact any kind of business in the unincorporated territory of El Dorado County without possessing a County business license unless exempt under County Ordinance Code Section 5.08.070. Contractor warrants and represents that it shall comply with all of the requirements of the County Business License Ordinance, where applicable, prior to beginning work under this Contract and at all times during the term of this Contract.

Article 29. CONTRACT ADMINISTRATOR

The County Officer or employee with responsibility for administering this Agreement is Russ Fackrell, Facilities Manager, Chief Administrative Office, or successor.

Article 30. AUTHORIZED SIGNATURES

The parties hereto represent that the undersigned individuals executing this Agreement on their behalf are fully authorized to do so by law or other appropriate instrument and to bind upon said parties the obligations set forth herein.

Article 31. PARTIAL INVALIDITY

If any provision of this Agreement is held by a court of competent jurisdiction to be invalid, void or unenforceable, the remaining provisions will continue in full force and effect without being impaired or invalidated in any way.

Article 32. ENTIRE AGREEMENT

This document and the documents referred to herein or exhibits hereto are the entire Agreement between the parties and they incorporate or supersede all prior written or oral agreements or understandings.

LIST OF EXHIBITS:

- **Exhibit A – Application and Certification of Payment**
- **Exhibit B1.1 – Johnson Center Scope Map**
- **Exhibit B1.2 – Johnson Center Roof Specifications**
- **Exhibit C1 – Johnson Center Existing Roof Details**

//

//

IN WITNESS WHEREOF, the County and Contractor have executed this Agreement on the dates indicated below, the latest shall be deemed to be the effective date of this Agreement.

COUNTY OF EL DORADO

By: _____ Dated: _____
_____, Chair
Board of Supervisors
County of El Dorado

ATTEST:
Kim Dawson, Clerk
Of the Board of Supervisors

By: _____ Dated: _____
Deputy Clerk

CONTRACTOR

By: _____ Dated: _____
President

By: _____ Dated: _____
Secretary

License No.: _____ Federal Employer Identification No. _____

NOTE: If Contractor is a corporation, the legal name of the corporation shall be set forth above together with the signature of the officer or officers authorized to sign contracts on behalf of the corporation; if Contractor is a co-partnership, the true name of the firm shall be set forth above together with the signature of the partner or partners authorized to sign contracts on behalf of the co-partnership; and if Contractor is an individual, his/her signature shall be placed above. Contractor executing this document on behalf of a corporation or partnership shall be prepared to demonstrate by resolution, article, or otherwise that it is appropriately authorized to act in these regards. For such corporation or partnership, such authority shall be demonstrated to the satisfaction of County. If signature is by an agent, other than officer of a corporation or a member of a partnership, an appropriate Power of Attorney shall be on file with the Department prior to signing this document.

Mailing Address: _____

Business Address: _____

City, Zip: _____

Phone: _____ Fax: _____

* END OF AGREEMENT *

CONTRACTOR'S GUARANTEE

JOHNSON CENTER ROOF REHABILITATION PROJECT

BID #20-968-053

As Contractor for the above referenced project, we hereby agree to repair or replace any or all work provided hereunder which is defective due to faulty materials, poor workmanship, or defective equipment at no expense to the County of El Dorado, ordinary wear and tear and unusual abuse or neglect excepted, during the term of the contract and provide the manufacturer one (1) year warranty period from the date of final acceptance of the work.

We further agree to repair or replace any and all adjacent areas which have been damaged or displaced due to our work performed under this contract at no expense to the County of El Dorado during the term of this contract for a period of one (1) year from the date of final acceptance of the work.

If a warranty or guarantee exceeding one (1) year is provided by the supplier or manufacturer of any equipment or materials used in this Project, or if a warranty or guarantee exceeding one (1) year is required elsewhere in these Contract Documents, then the guarantee for such equipment or materials shall be extended for such term. We expressly agrees to act as co-guarantor of such equipment and materials, and we shall supply County with all warranty and guaranty documents relative to equipment and materials incorporated in the job and guaranteed by its suppliers or manufacturers.

We agree that this guarantee and the rights and obligations accruing there from shall be in addition and not by way of limitation in any manner whatsoever to the rights, obligations, warranties or remedies otherwise provided for by law.

In the event of our failure to comply with the above mentioned conditions with ten (10) calendar days after being notified in writing by the County of El Dorado, we hereby authorize the County of El Dorado to proceed to have said defects repaired and made good at our expense and we will honor and pay all costs and charges therefore upon written demand.

EXECUTED on this _____ day of _____, 2020.

CONTRACTOR

By _____

Title _____

By _____

Title _____

*** END OF CONTRACTORS GUARANTEE ***

COUNTY OF EL DORADO

PAYMENT BOND

(Section 3247, Civil Code)

Bond No. _____

WHEREAS, the County of El Dorado, a political subdivision of the State of California, hereafter referred to as "Obligee", has awarded to Contractor

_____ hereafter referred to as "Principal", a contract for the work described as follows:

**JOHNSON CENTER ROOF REHABILITATION PROJECT
BID #20-968-053**

AND, WHEREAS, said Principal is required to furnish a bond in connection with said contract, guaranteeing the faithful performance thereof:

NOW, THEREFORE, we the undersigned Principal and Surety are held and firmly bound unto the Obligee, in the sum of _____ Dollars, (\$ _____) to be paid to the Obligee, for which payment we bind ourselves, jointly and severally.

THE CONDITION OF THIS OBLIGATION IS SUCH,

That if said Principal or its subcontractors shall fail to pay any of the persons named in Civil Code Section 3181, or amounts due under the Unemployment Insurance Code with respect to work or labor performed by such claimant, or any amounts required to be deducted, withheld, and paid over to the Franchise Tax Board from the wages of employees of the Principal and his subcontractors pursuant to Section 18806 of the Revenue and Taxation Code, with respect to such work and labor, that the Surety herein will pay for the same in an amount not exceeding the sum specified in this bond, otherwise the above obligation shall be void. In case suit is brought upon this bond, the Surety will pay a reasonable attorney's fee to be fixed by the court.

This bond shall inure to the benefit of any of the persons named in Civil Code Section 3181 as to give a right of action to such persons or their assigns in any suit brought upon this bond.

Dated: _____

Correspondence or Claims relating to this bond should be sent to the Surety at the following address:

PRINCIPAL

SURETY

ATTORNEY-IN-FACT

NOTE: Signatures of those executing for the Principal and for the Surety must be properly acknowledged, and a Power of Attorney attached for the Surety.

NOTARY ACKNOWLEDGMENTS ATTACHED

PRINCIPAL

A notary public or other officer completing this certificate verifies only the identity of the individual who signed the document to which this certificate is attached, and not the truthfulness, accuracy, or validity of that document.

ACKNOWLEDGMENT

State of California

County of _____

On _____ before me, _____,
(here insert name and title of the officer)

personally appeared _____

who proved to me on the basis of satisfactory evidence to be the person(s) whose name(s) is/are subscribed to the within instrument and acknowledged to me that he/she/they executed the same in his/her/their authorized capacity(ies), and that by his/her/their signature(s) on the instrument the person(s), or the entity upon behalf of which the person(s) acted, executed the instrument.

I certify under PENALTY OF PERJURY under the laws of the State of California that the foregoing paragraph is true and correct.

WITNESS my hand and official seal.

Signature _____

(Seal)

SURETY

A notary public or other officer completing this certificate verifies only the identity of the individual who signed the document to which this certificate is attached, and not the truthfulness, accuracy, or validity of that document.

ACKNOWLEDGMENT

State of California

County of _____

On _____ before me, _____,
(here insert name and title of the officer)

personally appeared _____

who proved to me on the basis of satisfactory evidence to be the person(s) whose name(s) is/are subscribed to the within instrument and acknowledged to me that he/she/they executed the same in his/her/their authorized capacity(ies), and that by his/her/their signature(s) on the instrument the person(s), or the entity upon behalf of which the person(s) acted, executed the instrument.

I certify under PENALTY OF PERJURY under the laws of the State of California that the foregoing paragraph is true and correct.

WITNESS my hand and official seal.

Signature _____

(Seal)

COUNTY OF EL DORADO

PERFORMANCE BOND

Bond No. _____

KNOW ALL MEN BY THESE PRESENTS, that we _____

the Contractor in the Contract hereto annexed, as Principal, and

as Surety, are held firmly bound unto the County of El Dorado, a political subdivision of the State of California, hereinafter

called the "Obligee" in the sum of _____ DOLLARS,

(\$ _____) lawful money of the United States, for which payment, well and truly to be made,

we bind ourselves, jointly and severally, firmly by these presents.

Signed, sealed and dated: _____

The condition of the above obligation is such that if said Principal as Contractor in the Contract hereto annexed shall faithfully perform each and all of the conditions of said Contract to be performed by him, and shall furnish all tools, equipment, apparatus, facilities, transportation, labor and material, other than material, if any, agreed to be furnished by the Obligee, necessary to perform and complete, and to perform and complete in a good and workmanlike manner, the work of **BID #20-968-053 for the JOHNSON CENTER ROOF REHABILITATION PROJECT** in strict conformity with the terms and conditions set forth in the Contract hereto annexed, then this obligation shall be null and void; otherwise this bond shall remain in full force and effect and the said Surety will complete the Contract work under its own supervision, by Contract or otherwise, and pay all costs thereof for the balance due under terms of the Contract, and the said Surety, for value received, hereby stipulates and agrees that no change, extension of time, alteration or addition to the terms of the Contract or to the work to be performed thereunder shall in any wise affect its obligation on this bond, and it does hereby waive notice of any such change, extension of time, alteration or addition to the terms of the Contract or to the work.

In the event suit is brought upon this bond by the Obligee and judgment is recovered, the Surety shall pay all costs incurred by the Obligee in such suit, including a reasonable attorney's fee to be fixed by the court.

This guarantee shall insure the Obligee during the work required by any Contract and for a period of one (1) year from the date of acceptance of the work against faulty or improper materials or workmanship that may be discovered during that time.

No right of action shall accrue under this bond to or for the use of any person other than the Obligee named herein.

Dated: _____, 20____.

Correspondence or Claims relating to this bond should be sent to the Surety at the following address:

PRINCIPAL

SURETY

ATTORNEY-IN-FACT

NOTE: Signatures of those executing for the Principal and the Surety must be properly acknowledged, and a Power of Attorney attached for the Surety.

NOTARY ACKNOWLEDGMENTS ATTACHED

PRINCIPAL

A notary public or other officer completing this certificate verifies only the identity of the individual who signed the document to which this certificate is attached, and not the truthfulness, accuracy, or validity of that document.

ACKNOWLEDGMENT

State of California

County of _____

On _____ before me, _____,
(here insert name and title of the officer)

personally appeared _____

who proved to me on the basis of satisfactory evidence to be the person(s) whose name(s) is/are subscribed to the within instrument and acknowledged to me that he/she/they executed the same in his/her/their authorized capacity(ies), and that by his/her/their signature(s) on the instrument the person(s), or the entity upon behalf of which the person(s) acted, executed the instrument.

I certify under PENALTY OF PERJURY under the laws of the State of California that the foregoing paragraph is true and correct.

WITNESS my hand and official seal.

Signature _____

(Seal)

SURETY

A notary public or other officer completing this certificate verifies only the identity of the individual who signed the document to which this certificate is attached, and not the truthfulness, accuracy, or validity of that document.

ACKNOWLEDGMENT

State of California

County of _____

On _____ before me, _____,
(here insert name and title of the officer)

personally appeared _____

who proved to me on the basis of satisfactory evidence to be the person(s) whose name(s) is/are subscribed to the within instrument and acknowledged to me that he/she/they executed the same in his/her/their authorized capacity(ies), and that by his/her/their signature(s) on the instrument the person(s), or the entity upon behalf of which the person(s) acted, executed the instrument.

I certify under PENALTY OF PERJURY under the laws of the State of California that the foregoing paragraph is true and correct.

WITNESS my hand and official seal.

Signature _____

(Seal)

YEAR

20 **Withholding Exemption Certificate**

CALIFORNIA FORM

590

(This form can only be used to certify exemption from nonresident withholding under California R&TC Section 18662. This form cannot be used for exemption from wage withholding.)

File this form with your withholding agent. (Please type or print)		Withholding agent's name	
Vendor/Payee's name		Vendor/Payee's <input type="checkbox"/> Social security number <input type="checkbox"/> SOS no. <input type="checkbox"/> California corp. no. <input type="checkbox"/> FEIN	
Vendor/Payee's address (number and street)		APT no.	Private Mailbox no. Vendor/Payee's daytime telephone no. ()
City	State	ZIP Code	

I certify that for the reasons checked below, the entity or individual named on this form is exempt from the California income tax withholding requirement on payment(s) made to the entity or individual. Read the following carefully and check the box that applies to the vendor/payee:

Individuals — Certification of Residency:

I am a resident of California and I reside at the address shown above. If I become a nonresident at any time, I will promptly inform the withholding agent. See instructions for Form 590, General Information D, for the definition of a resident.

Corporations:

The above-named corporation has a permanent place of business in California at the address shown above or is qualified through the California Secretary of State to do business in California. The corporation will withhold on payments of California source income to nonresidents when required. If this corporation ceases to have a permanent place of business in California or ceases to be qualified to do business in California, I will promptly inform the withholding agent. See instructions for Form 590, General Information E, for the definition of permanent place of business.

Partnerships:

The above-named partnership has a permanent place of business in California at the address shown above or is registered with the California Secretary of State, and is subject to the laws of California. The partnership will file a California tax return and will withhold on foreign and domestic nonresident partners when required. If the partnership ceases to do any of the above, I will promptly inform the withholding agent. **Note:** For withholding purposes, a Limited Liability Partnership is treated like any other partnership.

Limited Liability Companies (LLC):

The above-named LLC has a permanent place of business in California at the address shown above or is registered with the California Secretary of State, and is subject to the laws of California. The LLC will file a California tax return and will withhold on foreign and domestic nonresident members when required. If the LLC ceases to do any of the above, I will promptly inform the withholding agent.

Tax-Exempt Entities:

The above-named entity is exempt from tax under California R&TC Section 23701 _____ (insert letter) or Internal Revenue Code Section 501(c) _____ (insert number). The tax-exempt entity will withhold on payments of California source income to nonresidents when required. If this entity ceases to be exempt from tax, I will promptly inform the withholding agent.

Note: Individuals cannot be tax-exempt entities.

Insurance Companies, IRAs, or Qualified Pension/Profit Sharing Plans:

The above-named entity is an insurance company, IRA, or a federally qualified pension or profit-sharing plan.

California Irrevocable Trusts:

At least one trustee of the above-named irrevocable trust is a California resident. The trust will file a California fiduciary tax return and will withhold on foreign and domestic nonresident beneficiaries when required. If the trustee becomes a nonresident at any time, I will promptly inform the withholding agent.

Estates — Certification of Residency of Deceased Person:

I am the executor of the above-named person's estate. The decedent was a California resident at the time of death. The estate will file a California fiduciary tax return and will withhold on foreign and domestic nonresident beneficiaries when required.

CERTIFICATE: Please complete and sign below.

Under penalties of perjury, I hereby certify that the information provided herein is, to the best of my knowledge, true and correct. If conditions change, I will promptly inform the withholding agent.

Vendor/Payee's name and title (type or print) _____

Vendor/Payee's signature ► _____ Date _____

Instructions for Form 590

Withholding Exemption Certificate

References in these instructions are to the California Revenue and Taxation Code (R&TC).

General Information

A Purpose

Use Form 590 to certify an exemption from nonresident withholding. Complete and present Form 590 to the withholding agent. The withholding agent will then be relieved of the withholding requirements if the agent relies in good faith on a completed and signed Form 590 unless told by the Franchise Tax Board (FTB) that the form should not be relied upon.

Important – This form cannot be used for exemption from wage withholding. Any questions regarding wage withholding should be directed to the California Employment Development Department.

Do not use Form 590 if you are a seller of California real estate. Sellers of California real estate should use Form 593-C, Real Estate Withholding Certificate.

B Law

R&TC Section 18662 requires withholding of income or franchise tax on payments of California source income made to nonresidents of California.

Withholding is required on:

- Payments to nonresidents for services rendered in California;
- Distributions of California source income made to domestic nonresident partners and members and allocations of California source income made to foreign partners and members;
- Payments to nonresidents for rents if the payments are made in the course of the withholding agent's business;
- Payments to nonresidents for royalties for the right to use natural resources located in California;
- Distributions of California source income to nonresident beneficiaries from an estate or trust; and
- Prizes and winnings received by nonresidents for contests in California.

For more information on withholding and waiver requests, get FTB Pub. 1017, Nonresident Withholding Partnership Guidelines, and FTB Pub. 1023, Nonresident Withholding Independent Contractor, Rent and Royalty Guidelines. To get a withholding publication see General Information G.

C Who can Execute this Form

Form 590 can be executed by the entities listed on this form.

Note: In a situation where payment is being made for the services of a performing entity, this form can only be completed by the performing entity or the performing entity's partnership or corporation. It **cannot** be completed by the performing entity's agent or other third party.

Note: The grantor of a revocable/grantor trust shall be treated as the vendor/payee for withholding purposes. Therefore, if the vendor/payee is a revocable/grantor trust and one or more of the grantors is a nonresident, withhold-

ing is required. If all of the grantors of a revocable/grantor trust are residents, no withholding is required. Resident grantors can check the box on Form 590 labeled "Individuals — Certification of Residency."

D Who is a Resident

A California resident is any individual who is in California for other than a temporary or transitory purpose or any individual domiciled in California who is absent for a temporary or transitory purpose.

An individual domiciled in California who is absent from California for an uninterrupted period of at least 546 consecutive days under an employment-related contract is considered outside California for other than a temporary or transitory purpose.

Note: Return visits to California that do not total more than 45 days during any taxable year covered by the employment contract are considered temporary.

This provision does not apply if an individual has income from stocks, bonds, notes, or other intangible personal property in excess of \$200,000 in any taxable year in which the employment-related contract is in effect.

A spouse who is absent from California for an uninterrupted period of at least 546 days to accompany a spouse who is under an employment-related contract is considered outside of California for other than a temporary or transitory purpose.

Generally, an individual who comes to California for a purpose which will extend over a long or indefinite period will be considered a resident. However, an individual who comes to perform a particular contract of short duration will be considered a nonresident. For assistance in determining resident status, get FTB Pub. 1031, Guidelines for Determining Resident Status, or call the Franchise Tax Board at (800) 852-5711 or (916) 845-6500 (not toll-free).

E What is a Permanent Place of Business

A corporation has a permanent place of business in California if it is organized and existing under the laws of California or if it is a foreign corporation qualified to transact intrastate business by the California Secretary of State. A corporation that has not qualified to transact intrastate business (e.g., a corporation engaged exclusively in interstate commerce) will be considered as having a permanent place of business in California only if it maintains a permanent office in California that is permanently staffed by its employees.

F Withholding Agent

Keep Form 590 for your records. Do not send this form to the FTB unless it has been specifically requested.

Note: If the withholding agent has received Form 594, Notice to Withhold Tax at Source, only the performing entity can complete and

sign Form 590 as the vendor/payee. If the performing entity completes and signs Form 590 indicating no withholding requirement, you must send a copy of Form 590 with Form 594 to the FTB.

For more information, contact the Withholding Services and Compliance Section. See General Information G.

The vendor/payee must notify the withholding agent if:

- The individual vendor/payee becomes a nonresident;
- The corporation ceases to have a permanent place of business in California or ceases to be qualified to do business in California;
- The partnership ceases to have a permanent place of business in California;
- The LLC ceases to have a permanent place of business in California; or
- The tax-exempt entity loses its tax-exempt status.

The withholding agent must then withhold. Remit the withholding using Form 592-A, Nonresident Withholding Remittance Statement, and complete Form 592, Nonresident Withholding Annual Return, and Form 592-B, Nonresident Withholding Tax Statement.

G Where to get Publications, Forms, and Additional Information

You can download, view, and print FTB Publications 1017, 1023, 1024, and nonresident withholding forms, as well as other California tax forms and publications not related to nonresident withholding from our Website at: www.ftb.ca.gov

To have publications or forms mailed to you or to get additional nonresident withholding information, please contact the Withholding Services and Compliance Section.

WITHHOLDING SERVICES AND
COMPLIANCE SECTION
FRANCHISE TAX BOARD
PO BOX 942867
SACRAMENTO CA 94267-0651

Telephone: (888) 792-4900
(916) 845-4900 (not toll-free)
FAX: (916) 845-9512

Assistance for persons with disabilities:

We comply with the Americans with Disabilities Act. Persons with hearing or speech impairments please call TTY/TDD (800) 822-6268.

Asistencia bilingüe en español

Para obtener servicios en español y asistencia para completar su declaración de impuestos/formularios, llame al número de teléfono (anotado arriba) que le corresponde.



County of El Dorado

OFFICE OF AUDITOR-CONTROLLER

JOE HARN, CPA
Auditor-Controller

BOB TOSCANO
Assistant Auditor-Controller

360 FAIR LANE
PLACERVILLE, CALIFORNIA 95667
Phone: (530) 621-5487 FAX: (530) 295-2535

PAYEE DATA RECORD

(Required in lieu of IRS W-9 when receiving payment from the County of El Dorado) Version: April 2014

PAYEE DATA RECORD	INSTRUCTIONS: Complete all information on this form. Sign, date, and return to the address shown at the bottom of this page. Prompt return of the fully completed form will prevent delays in processing payments. Information provided in this form will be used by the County of El Dorado to prepare Information Returns (Forms 1099), for withholding on payments to nonresident payees, and for reporting to the Employment Development Department (EDD).		
NAME AND ADDRESS	Name (as shown on your income tax return)		
	Business name/Doing business as/Disregarded entity name, if different from above		
	Physical address (number, street, and apt. or suite)		Remittance address (if different than physical)
	City, state, zip code		City, state, zip code
	Phone number	Fax number (optional)	Email (optional)
FEDERAL TAX CLASSIFICATION & EXEMPTIONS	Check appropriate federal tax classification <input type="radio"/> Individual / sole proprietor <input type="radio"/> Partnership <input type="radio"/> Trust / estate <input type="radio"/> Other (see instructions) ▶ _____ <input type="radio"/> C Corporation <input type="radio"/> S Corporation If you are a corporation, do you provide legal or medical services? <input type="radio"/> Yes <input type="radio"/> No <input type="radio"/> Limited liability company. Enter the tax classification (C=C Corporation, S=S Corporation, P=Partnership) _____		
	NOTE: IF YOU ARE A SINGLE MEMBER LLC (DISREGARDED ENTITY), ENTER THE TAX CLASSIFICATION OF THE OWNER IDENTIFIED ON THE NAME LINE.		
	Exempt payee code (if any) – see instructions _____ Exemption from FATCA reporting code (if any) – see instructions _____		
TAX IDENTIFICATION NUMBER	Tax identification number (TIN) Enter your TIN in the appropriate box. If you are an individual or sole proprietor, you must enter your SSN. You may choose to provide your EIN in addition to, but not instead of, the SSN. Single member LLCs (disregarded entities) must enter the TIN of the owner identified on the Name line.		
			Social Security Number - - Employer Identification Number -
RESIDENCY STATUS	Check appropriate box for residency status <input type="radio"/> California resident / exempt from nonresident withholding – qualified to do business in California or maintains a permanent place of business in California (attach CA Form 590) <input type="radio"/> California nonresident (see instructions)		
	NOTE: Payments to California nonresidents for services performed in California and for certain rents derived from properties located in California that exceed \$1,500 in a calendar year will be subject to 7% nonresident withholding unless you have obtained a waiver or have been approved for reduced withholding by the Franchise Tax Board. There is no withholding on payments for product and for services performed outside of California.		
	<input type="checkbox"/> Obtained Franchise Tax Board waiver of State withholding (attach a copy if applicable) <input type="checkbox"/> Obtained Franchise Tax Board approval for reduced withholding (attach a copy if applicable)		
California sales tax permit number (required only for California nonresident vendors that charge California sales tax)			
CERTIFICATION	Under penalties of perjury, I certify that: 1) the TIN shown on this form is my correct taxpayer identification number (or I am waiting for a number to be issued to me) and 2) I am not subject to backup withholding and 3) I am a U.S. citizen or other U.S. person and 4) the FATCA code(s) entered on this form (if any) indicating that I am exempt from FATCA reporting is correct.		
	Authorized Payee Representative's Name (Type or Print)		Title
	Signature	Date	Telephone

RETURN FORM TO	Should my residency status or any other information provided above change, I will promptly notify County of El Dorado at the address listed above.		
	Please return completed form to:		
	Department/office:		_____
	Mailing address:		_____
Phone:	Fax:	Email:	

COUNTY OF EL DORADO, PAYEE DATA RECORD (REVERSE)

<p>PAYEE DATA RECORD</p>	<p>A completed Payee Data Record is required for payments to all entities and will be kept on file at the County of El Dorado Auditor-Controller's Office. Payees who do not wish to complete the Payee Data Record may elect to not do business with the County of El Dorado. If the payee does not complete the form and the required payee data is not otherwise provided, payment may be reduced for federal backup withholding, California backup withholding and California nonresident withholding.</p>
<p>FEDERAL TAX CLASSIFICATION</p>	<p>Check the applicable federal tax classification. Note that if an LLC is disregarded as an entity separate from its owner, enter the appropriate tax classification of the owner identified on the "Name" line.</p> <p>Individual: Enter the name shown on your income tax return. If the account is in joint names, list first, and then circle, the name of the person or entity whose SSN you entered on the form.</p> <p>Sole proprietor: Enter your individual name as shown on your income tax return on the "Name" line. You may enter your business, trade, or "doing business as" name on the "Business name/Doing business as/Disregarded entity name" line.</p> <p>Partnership, C Corporation, or S Corporation: Enter the entity's name on the "Name" line and any business, trade, or "doing business as" name on the "Business name/Doing business as/Disregarded entity name" line.</p> <p>Disregarded entity: Enter the owner's name on the "Name" line. The name of the entity entered on the "Name" line should never be a disregarded entity. The name on the "Name" line must be the name shown on the income tax return on which the income should be reported. Check the appropriate box for the U.S. federal tax classification of the person whose name is entered on the "Name" line (individual/sole proprietor, partnership, C corporation, S corporation, trust/estate).</p> <p>Limited liability company (LLC): If the person identified on the "Name" line is an LLC, check the "Limited Liability Company" box only and enter the appropriate code for the U.S. federal tax classification.</p> <p>Other entities: Enter your business name as shown on required U.S. federal tax documents on the "Name" line. This name should match the name shown on the charter or other legal document creating the entity. You may enter any business, trade or DBA name on the "Business name/Doing business as/Disregarded entity name" line.</p>
<p>EXEMPTIONS</p>	<p>Exemptions: If you are exempt from backup withholding and/or FATCA reporting, enter in the exemptions box any code(s) that may apply to you. Generally, individuals (including sole proprietors) are not exempt from backup withholding. Corporations are exempt from backup withholding for certain payments, such as interest and dividends. Corporations are not exempt from backup withholding for payments made in settlement of payment card or third party network transactions. The following codes identify payees that are exempt from backup withholding: 1 – an organization exempt from tax under section 501(a), any IRA, or a custodial account under section 403(b)(7) if the account satisfies the requirements of section 401(f)(2); 2 – The United States or any of its agencies or instrumentalities; 3 – A state, the District of Columbia, a possession of the United States, or any of their political subdivisions or instrumentalities; 4 – A foreign government or any of its political subdivisions, agencies, or instrumentalities; 5 – A corporation; 6 – A dealer in securities or commodities required to register in the United States, the District of Columbia, or a possession of the United States; 7 – A futures commission merchant registered with the Commodity Futures Trading Commission; 8 – A real estate investment fund; 9 – An entity registered at all times during the tax year under the Investment Company Act of 1940; 10 – A common trust fund operated by a bank under section 584(a); 11 – A financial institution; 12 – A middleman known in the investment community as a nominee or custodian; 13 – A trust exempt from tax under section 664 or described in section 4947.</p> <p>Exemption from FATCA reporting. The following codes identify payees that are exempt from reporting under FATCA. These codes apply to persons submitting this form for accounts maintained outside of the United States by certain foreign financial institutions. Therefore, if you are only submitting this form for an account you hold in the United States, you may leave this field blank. Consult with the person requesting this form if you are uncertain if the financial institution is subject to these requirements. A—An organization exempt from tax under section 501(a) or any individual retirement plan as defined in section 7701(a)(37); B—The United States or any of its agencies or instrumentalities; C—A state, the District of Columbia, a possession of the United States, or any of their political subdivisions or instrumentalities; D—A corporation the stock of which is regularly traded on one or more established securities markets, as described in Reg. section 1.1472-1(c)(1)(i); E—A corporation that is a member of the same expanded affiliated group as a corporation described in Reg. section 1.1472-1(c)(1)(i); F—A dealer in securities, commodities, or derivative financial instruments (including notional principal contracts, futures, forwards, and options) that is registered as such under the laws of the United States or any state.</p>
<p>TAX IDENTIFICATION NUMBER</p>	<p>Enter your tax identification number (TIN) in the appropriate box. If you are a single member LLC that is disregarded as an entity separate from its owner, enter the owner's SSN (or EIN, if the owner has one). Do not enter the disregarded entity's EIN. If the LLC is classified as a corporation or partnership, enter the entity's EIN. The TIN for individuals and sole proprietors is the Social Security Number (SSN). Sole proprietors may provide their EIN in addition to but not instead of a SSN.</p> <p>The County of El Dorado requires that all parties entering into business transactions that may lead to payment(s) from the County provide their Taxpayer Identification Number (TIN). The TIN is also required by the California Revenue and Taxation Code Section 18646 to facilitate tax compliance enforcement activities and the preparation of Form 1099 and other information returns as required by the Internal Revenue Code Section 6109(a).</p>
<p>RESIDENCY STATUS</p>	<p>Are you a California resident or nonresident?</p> <p>A corporation will be defined as a "resident" if it has a permanent place of business in California or is qualified through the Secretary of State to do business in California. A partnership is considered a resident partnership if it has a permanent place of business in California. An estate is a resident if the decedent was a California resident at time of death. A trust is a resident if at least one trustee is a California resident. For individuals and sole proprietors, the term "resident" includes every individual who is in California for other than a temporary or transitory purpose and any individual domiciled in California who is absent for a temporary or transitory purpose. Generally, an individual who comes to California for a purpose that will extend over a long or indefinite period will be considered a resident. However, an individual who comes to perform a particular contract of short duration will be considered a nonresident.</p> <p>Payments to all nonresidents may be subject to withholding. Nonresident payees performing services in California or receiving certain rent, lease, or royalty payments from property (real or personal) located in California will have 7% of their total payments withheld for State income taxes. However, no withholding is required if total payments to the payee are \$1,500 or less for the calendar year or if payment is for product. Nonresidents who have been granted a waiver on payments of California source income from the California Franchise Tax Board must submit a copy of the waiver. For information on Nonresident Withholding, contact the Franchise Tax Board at the numbers listed below:</p> <p style="text-align: center;">Withholding Services and Compliance Section: 1-888-792-4900 E-mail address: wscs.gen@ftb.ca.gov</p> <p style="text-align: center;">For hearing impaired with TDD, call: 1-800-822-6268 Website: www.ftb.ca.gov</p> <p>California nonresidents charging California sales tax are required to provide their California sales tax number.</p>
<p>CERTIFICATION</p>	<p>Provide the name, title, signature, and telephone number of the authorized individual completing this form. Provide the date the form was completed. NOTE: You must cross out item 2 in the certification block if you have been notified by the IRS that you are currently subject to backup withholding because you have failed to report all interest and dividends on your tax return.</p>

CERTIFICATE OF INSURANCE FORM FOR CONTRACTORS, ARCHITECTS AND/OR ENGINEERS

CERTIFICATE ISSUER PHONE ()	DATE EXECUTED: THIS CERTIFICATE DOES NOT AMEND, EXTEND, OR ALTER THE COVERAGE AFFORDED BY THE POLICIES BELOW. COMPANIES AFFORDING COVERAGE		
INSURED PHONE ()	COMPANY A LETTER COMPANY B LETTER COMPANY C LETTER	COMPANY RATING COMPANY RATING COMPANY RATING	
PROJECT DESCRIPTION PROJECT TITLE: PROJECT NUMBER: LOCATION:	COMPANY D LETTER COMPANY E LETTER	COMPANY RATING COMPANY RATING	

THIS IS TO CERTIFY that policies of insurance listed below have been issued to the insured named above for the policy period indicated. Notwithstanding any requirement, term or condition of any contract or other document with respect to which this certificate may be issued or may pertain, the insurance afforded by the policies described herein is subject to all the terms, exclusion and conditions of such policies.

CL	Type of Insurance Coverage	Policy Number	Policy Effective Date	Policy Expiration Date	Limits of Liability (in Thousands)
	GENERAL LIABILITY <input type="checkbox"/> Commercial General Liability <input type="checkbox"/> Occurrence <input type="checkbox"/> Claims Made <input type="checkbox"/> Owner's & Contractor's Protective <input type="checkbox"/> General Aggregate * <input type="checkbox"/> Per Project <input type="checkbox"/> Per Location				GENERAL AGGREGATE \$ PRODUCTS-COMP/OPS AGGREGATE \$ PERSONAL & ADVERTISING INJURY \$ EACH OCCURRENCE \$ FIRE DAMAGE (ANY ONE FIRE) \$ MEDICAL EXPENSES (ANY ONE PERSON) \$ DEDUCTIBLE \$
	ARCHITECT'S AND/OR ENGINEER'S PROFESSIONAL LIABILITY <input type="checkbox"/> Claims Made <input type="checkbox"/> Project				GENERAL AGGREGATE \$ EACH CLAIM \$ DEDUCTIBLE \$
	AUTOMOBILE LIABILITY <input type="checkbox"/> Any Auto <input type="checkbox"/> All Owned Autos <input type="checkbox"/> Scheduled Autos <input type="checkbox"/> Hired Autos <input type="checkbox"/> Non-Owned Autos <input type="checkbox"/> Garage Liability				COMBINED SINGLE LIMIT \$ BODILY INJURY (PER PERSON) \$ BODILY INJURY (PER ACCIDENT) \$ PROPERTY DAMAGE \$ DEDUCTIBLE \$
	EXCESS LIABILITY <input type="checkbox"/> Umbrella Form <input type="checkbox"/> Other Than Umbrella Form				EACH OCCURRENCE \$ AGGREGATE \$
	<input type="checkbox"/> WORKER'S COMPENSATION				-----STATUTORY-----
	EMPLOYER'S LIABILITY				(EACH ACCIDENT) \$ (DISEASE - POLICY LIMIT) \$ (DISEASE - EACH EMPLOYEE) \$
	OTHER <input type="checkbox"/> Installation Floater <input type="checkbox"/> Builder's Risk <input type="checkbox"/>				\$ \$ \$

* The General Aggregate limit, under Limits of Insurance, applies separately to each of the projects away from premises owned by or rented by you.

DESCRIPTION OF OPERATIONS/LOCATIONS/VEHICLES/SPECIAL ITEMS/ADDITIONAL INSURED: The County of El Dorado its officers, officials, employees and volunteers are made additional insured, but only insofar as the operations under this contract are concerned. OTHER ADDITIONAL ISSUED:
--

CERTIFICATE HOLDER	SHOULD ANY OF THE ABOVE DESCRIBED POLICIES BE CANCELLED OR TERMINATED BEFORE THE EXPIRATION DATE THEREOF, THE ISSUING COMPANY WILL GIVE THIRTY (30) DAYS WRITTEN NOTICE TO THE CERTIFICATE HOLDER NAMED TO THE LEFT, IN ADVANCE OF THE EFFECTIVE DATE OF SUCH CANCELLATION OR TERMINATION. AUTHORIZED REPRESENTATIVE SIGNATURE, TITLE, TYPED NAME, SSN AND PHONE NUMBER:
--------------------	---

COUNTY OF EL DORADO
JOHNSON CENTER ROOF REHABILITATION PROJECT

BID #20-968-053

CONDITIONS OF THE CONTRACT

ARTICLE 1

GENERAL PROVISIONS

1.1 BASIC DEFINITIONS

1.1.1 County: The County of El Dorado, a political subdivision of the State of California.

1.1.2 Owner: The County of El Dorado is the Owner and is identified as the Owner in the Contract and these Contract Conditions. The term Owner, and pronouns in place of the same shall mean the County of El Dorado acting by and through its duly authorized representative.

1.1.3 Owner's Representative: The Chief Administrative Office, Facilities Manager, or designated representative.

1.1.4 Architect: The person holding a valid California State Architect's license, whose firm has been designated within the Contract Documents as the Architect to provide services on the Project. When the Architect is referred to within the Contract Documents and no Architect has in fact been designated, then the matter shall be referred to the County and shall be interpreted as Owner's Representative.

1.1.5 Project Manager: Project Manager or such other designated representative of the Owner. The Project Manager has such duties and authority as may be set forth in the Contract Documents.

1.1.6 Contractor: The person or entity identified as such in the Contract and is referred to throughout the Contract Documents as if singular in number. The term Contractor refers to the Contractor or the Contractor's authorized representative.

1.1.7 Inspector: The individual designated by the Owner as the Inspector as set forth in Paragraph 2.1.2.

1.1.8 Subcontractor: Those contractors, of whatever tier, furnishing labor or material, or both, for the Work under the Contract with the Contractor.

1.1.9 Substantial Completion: The stage in the progress of the Work when the Work or designated portion thereof is sufficiently complete in accordance with the Contract Documents so the Owner can occupy or utilize the Work for its intended use.

1.1.10 Final Acceptance: Conditions upon which the County will accept Work as satisfactorily completed in accordance with the Contract Documents. Requirements include, but are not limited to:

1. All Systems having been tested and accepted as having met requirements of the Contract Documents.

2. One (1) PDF format and one (1) hard copy of all as-builts, manufacturer's product data and maintenance manuals having been submitted by the Contractor and reviewed and accepted by the Owner.
 3. All punch list work, as directed by the Owner, having been completed by the Contractor.
 4. Acceptance of the Work by the Owner.
- 1.1.11 Final Payment: The Final Payment shall be the only Payment made to Contractor and shall not be considered to be the payment of any or all of the retention.
- 1.1.12 Architect's Supplemental Instructions/Instruction Bulletins: A written order of the Architect and reviewed by the Owner's Representative directing the Contractor to provide supplemental instructions, interpretations, or conduct minor changes in work involving neither extra cost nor extra time and being consistent with the scope and functioning of the project, if applicable.
- 1.1.13 Construction Change Directive: A written order issued by the Owner directing a change in the Work and stating a proposed basis for adjustment, if any, of Contract Time or Sum. The Owner may by Change Directive, without invalidating the Contract and without Contractor's agreement, order changes in the Work. This procedure will be used in the absence of agreement between Owner and Contractor, for subsequent inclusion in a Change Order.
- 1.1.14 Change Order: A Change Directive signed by the Owner and Contractor stating their agreement upon all of the following: 1) a change in the Work, 2) the amount of the adjustment in the Contract Price, if any, and 3) the extent of the adjustment in the Contract Time, if any.
- 1.1.15 Contract Documents: The Contract Documents shall include the documents described in Article 2 of the Contract, including Architect's Supplemental Instructions, Construction Change Directives, and Change Orders.
- 1.1.16 Work: The construction and services required by the Contract Documents, including all labor, materials, equipment and services provided or to be provided by the Contractor to fulfill the Contractor's obligations.
- 1.1.17 Project: The total construction of the Work performed under the Contract Documents.
- 1.1.18 Plans: The graphic and pictorial portions of the Contract Documents, wherever located and whenever issued, showing the design, location and dimensions of the Work, generally including plans, elevations, sections, details, schedules, and diagrams, specifically Exhibit B1.1-Johnson Center Scope Map and Exhibit C1-Johnson Center Original Roof Details.
- 1.1.19 Technical Specifications: That portion of the Contract Documents Division 1 through 26 consisting of the technical written requirements for materials, equipment, construction systems, standards and workmanship for the Work, and performance of related services.
- 1.1.20 Claim: A demand or assertion by the Contractor seeking, as a matter of right, adjustment or interpretation of Contract terms, payment of money, extension of time, or other relief with respect to the terms of the Contract. Claims must be made by written notice and shall include a demand for the Owner's decision. The responsibility to substantiate claims and to resolve the claims of subcontractors of whatever tier shall rest with the Contractor.
- 1.1.21 Work Not Included: Except for such auxiliary work as shown or specified, or is necessary as part of the construction, the following is NOT included in this contract: Any work shown but marked "Not in Contract" (NIC) or otherwise designated to be done under another contract or by Owner.
- 1.1.22 Furnish (material): To supply and deliver to the project ready for installation and in operating condition.

- 1.1.23 **Install (service or labor):** To place in final position, complete, anchored, connected, and in operable condition with respect to required codes and/or governing agency requirements.
- 1.1.24 **Provide:** To furnish and install complete. When “Furnish”, “Install”, or “Provide” is stated, “Provide” is implied.
- 1.1.25 **Construct:** To “Furnish” materials to “Install” in final position, complete, anchored, and connected with respect to required codes, requirements, Contract Documents, and details.
- 1.1.26 **Day(s):** All references to “day” or “days” in these Contract Documents shall be defined as calendar-day or calendar-days.
- 1.1.27 **Normal Working Hours:** Includes the hours from 7:30 a.m. to 4:30 p.m. Monday through Friday, except for County holidays.

1.2 CONTRACT DOCUMENTS

- 1.2.1 **One Document:** The Contract Documents are one document and any work shown or mentioned shall be performed or furnished. The Contractor admits and agrees that the Contract Documents exhibit the intent and purpose of the Owner in regard to the Work, and that they are not complete in every detail and are to be considered as showing the purpose and intent only; and Contractor further agrees to furnish all labor or material for any detail that is necessary to carry out the intent and purpose of the Specifications without extra charge.
- 1.2.2 **Misuse of Words or Punctuation:** The misplacement, addition, or omission of any word, letter, or punctuation mark will not in any way change the intent or meaning of the Contract Documents. Any part of the Work, or any article pertaining thereto which is not specifically set forth in these Contract Documents, but which is necessary for the proper completion of the Work, is to be supplied and set in place at the Contractor's expense, the same as if it had been mentioned in these Contract Documents. The Contractor shall furnish all things necessary to make a good and workmanlike job in accordance with the intent and purpose of the Contract Documents.

1.3 ASSIGNMENT OF CONTRACT

- 1.3.1 **Mutual Consent:** Neither party to the Contract shall assign the Contract without the written consent of the other party, nor shall the Contractor assign any moneys due or to become due to him hereunder without the written consent of the Owner.
- 1.3.2 **Assignment Under Anti-Trust Claims:** In accordance with Section 4552 of the California Government Code, and Section 7103 of the Public Contract Code, Contractor and subcontractors shall conform to the following requirements:
1. In entering into a public works contract or a subcontract to supply goods, services, or materials pursuant to a public works contract, Contractor or subcontractors offers and agrees to assign to the Owner all rights, title, and interest in and to all causes of action it may have under Section 4 of the Clayton Act (15 U.S.C Section 15) or under the Cartwright Act, [Chapter 2 (commencing with Section 16700) of Part 2 of Division 7 of the Business and Professions Code], arising from purchases of goods, services, or materials pursuant to the public works contract or the subcontract. This assignment shall be made and become effective at the time the Owner tenders Final Payment to the Contractor, without further acknowledgment by the parties.

2. If an awarding body or public purchasing body receives, either through judgment or settlement, a monetary recovery for a cause of action assigned under Government Code Sections 4550-4554, the assignor shall be entitled to receive reimbursement for actual legal costs incurred and may, upon demand, recover from the public body any portion of the recovery, including treble damages, attributable to overcharges that were paid by the assignor but were not paid by the public body as part of the bid price, less the expenses incurred in obtaining that portion of the recovery. Upon demand in writing by the assignor, the assignee shall, within one year from such demand, reassign the cause of action assigned under Government Code Sections 4550-4554 if the assignor has been or may have been injured by the violation of law for which the cause of action arose and (a) the assignee has not been injured thereby, or (b) the assignee declines to file a court action for the cause of action.

1.4 WAIVER OF "COMMON PRACTICE"

- 1.4.1 The Contractor shall waive "common practice" and "common usage" as construction criteria wherever the Contract Documents details, plans, technical specifications, governing codes, or ordinances require greater quantity or better quality than common practice or common usage would require.

1.5 EXCESSIVE COSTS

- 1.5.1 Failure to Comply with Contract: If Contractor fails to comply with any Contract requirements, including any required coordination with other contractors, and that failure results in additional costs to Owner, then Contractor shall be liable for such additional costs.
- 1.5.2 Construction Methods: If Contractor's construction methods and techniques result in additional costs to Owner, after notice, such Contractor shall be responsible for cost attributable to his methods and techniques.

ARTICLE 2

OWNER

2.1 OWNER'S REPRESENTATIVE

- 2.1.1 Owner Representative: The Owner will be represented by the Owner's Representative who shall oversee the performance of the Contract on behalf of the Owner.
- 2.1.2 Owner May Appoint Inspector: Owner shall be entitled to appoint an agent as Inspector who shall see that the performance of the Work is in strict accordance with the Contract Documents on behalf of the Owner.
- 2.1.3 Communication: In order that the Owner may act upon expert advice and upon good procedure, all communications from the Contractor shall be in writing and will be through said Owner's Representative or Inspector, as the Owner may direct, and all communications and instructions from the Owner to the Contractor will be so routed. The Owner reserves the right to alter this procedure without the consent of the Contractor. All communications not in compliance herewith, shall be considered non-binding on the Owner.

2.2 RIGHTS OF OWNER

- 2.2.1 Right to Clean Up: Subject to the strict prohibition against maintaining a nuisance, if a dispute arises between the Contractor, Subcontractors, or separate contractors as to the responsibility under their respective Contracts for maintaining the premises and surrounding area free from waste materials and

rubbish the Owner may, but need not, clean up and allocate the cost among those responsible as the Inspector determines to be just.

2.2.2 **Right to Accept Imperfect Work:** If any part or portion of the Work completed under this Contract is defective and not in accordance with the Plans or Contract Documents, and if the imperfection is judged by Owner to be not of sufficient magnitude or importance so as to make the Work unacceptable, then Owner shall have the right and authority to retain such Work but will make such deductions in Contract Price as may be equitable and reasonable. However, Owner does not by this section; waive any other rights provided for herein.

2.2.3 **Right to do Adjacent Work:** The Owner reserves the right to perform construction or operations on the site of the Work. In doing this Owner may use its own forces or award separate contracts in connection with other construction or operations on the site but not covered by the Contract Documents. Contractor shall defend, indemnify, and hold Owner harmless for costs incurred by Owner that are payable to a separate contractor because of delays, improperly timed activities, or defective construction by the Contractor, unless such costs are incurred due to the sole or active negligence of Owner.

2.2.4 **Right to Finish Contractor's Work:** If the Contractor defaults or neglects to carry out all or any part of the Work in accordance with the Contract Documents, the Owner has the right, exercisable solely at Owner's discretion, to commence and continue completion of the Work with diligence and promptness. In such an event, if the Owner's cost to complete to Work exceeds the remaining balance of the Contract with the Contractor, Contractor shall reimburse the Owner for such excess costs.

2.2.5 **Right of Partial Use of Project:** The Owner may occupy or use any completed or partially completed portion of the Work at any stage, upon agreement of Owner and Contractor.

1. Such partial occupancy or use may commence whether or not the portion is substantially complete, provided the Owner and Contractor have accepted in writing the responsibilities assigned to each of them for payments, retainage if any, security, maintenance, heat, utilities, damage to work and insurance, and have agreed in writing concerning the period for correction of the Work and commencement of warranties required by the Contract Documents.
2. Consent of the Contractor to partial occupancy or use shall not be unreasonably withheld.
3. Immediately prior to such partial occupancy or use, the Owner and Contractor shall jointly inspect the area to be occupied or portion of the Work to be used in order to determine and record the condition of the Work.
4. Unless otherwise agreed upon in writing, partial occupancy or use of a portion or portions of the Work shall not constitute acceptance of work not complying with the requirements of the Contract Documents.
5. No claim for acceleration, delay, or hindrance, may be made by Contractor on his own behalf or that of any of his subcontractors, for any delays, accelerations, or hindrances that may arise out of Owner's partial occupancy of the Project.

2.2.6 **Right to Audit:** Contractor shall maintain and make available to the County, State Auditor, or to any of their duly authorized representatives all books, papers, job cost records, detailed cost estimates, claims, and accounts, including payment, property, payroll, personnel, subcontractor records, and financial records related to or which arise out of the Work or under terms of this Contract. Contractor shall maintain such books, records, data and documents in accordance with generally accepted accounting principles and in accordance with these Contract Conditions and federal and state requirements. These books, papers, records, claims, and accounts shall be made available for examination during normal business hours and shall be readily available and accessible at Contractor's principal place of business in California, for audit during normal business hours at such place of business. Contractor shall provide office space, photocopies and other assistance to enable audit or inspection representatives to conduct such audits or inspections.

This right to audit books and records directly related to this Contract shall also extend to any first-tier subcontractors employed under this Contract. Contractor shall incorporate this provision in any subcontract entered into as a result of this Contract and shall require its subcontractors to agree to cooperate with the above-listed agencies by making all appropriate and relevant Project records available to those agencies for audit and copying.

All of Contractor's books, papers, job cost records, detailed cost estimates, claims, and accounts, including payment, property, payroll, personnel, subcontractor records, and financial records related to or which arise out of the work or under terms of this Contract shall be retained for access, inspection and/or audit by the County, the State Auditor, or their duly authorized representatives for at least three (3) years after County's final payment to Contractor and/or the final resolution of any claims under this Contract. Contractor shall incorporate this provision in any subcontract entered into as a result of this Contract.

2.3 RESPONSIBILITIES OF OWNER

2.3.1 Removal, Relocation, or Protection of Underground Infrastructure: If the Contractor while performing the contract discovers utility facilities not identified by the Owner in the contract plans or specifications, Contractor shall immediately notify the Owner in writing. Owner shall have the sole discretion to perform the repairs or relocation work itself, or to permit the Contractor to do such repairs or relocation work at a reasonable price. In the event that the Owner authorizes the Contractor to perform the work, the parties shall proceed with a written Change Order as set forth in Article 5 herein. Compensation to the Contractor for said costs shall be in accordance with Section 4215 of the Government Code.

Nothing herein shall be construed to require the Owner to locate the presence of any existing services not expressly included in Government Code Section 4215, nor to limit the Owner's rights or remedies set forth therein.

In accordance with the provisions of Section 4215 of the California Government Code, Contractor shall not be assessed liquidated damages for delay in completion of the project, when such delay was caused by the failure of the Owner or owner of the utility to provide for the removal or relocation of such utility facilities.

ARTICLE 3

CONTRACTOR'S RESPONSIBILITIES

3.1 REVIEW OF CONTRACT DOCUMENTS AND FIELD CONDITIONS

3.1.1 Reporting Errors in Contract Documents: The Contractor shall carefully study and compare the Contract Documents with each other and shall at once report to the Inspector errors, inconsistencies, or omissions discovered. If the Contractor performs any construction activity knowing it involves a recognized error, inconsistency, or omission in the Contract Documents without such notice to the Owner, the Contractor shall assume responsibility for such performance and shall bear all costs for correction.

3.1.2 Reporting Errors in Field Conditions: The Contractor shall take field measurements and verify field conditions and shall carefully compare such field measurements and conditions and other information known to the Contractor with the Contract Documents before commencing activities. Errors, inconsistencies, or omissions discovered shall be reported to the Owner at once.

3.1.3 No Implied Warranty: No warranty is to be implied nor shall any warranty arise by operation of law, or by interpretation of this Contract, that the Plans and Contract Documents are adequate and sufficient to construct the Project.

3.2 SUPERVISION AND CONSTRUCTION PROCEDURES

- 3.2.1 Supervision of Work: The Contractor shall supervise and direct the Work, using the Contractor's best skill and attention. The Contractor shall be solely responsible for and have control over construction means, methods, techniques, sequences, and procedures and for coordinating all portions of the Work under the Contract, unless Contract Documents give other specific instructions concerning these matters.
- 3.2.2 Acts of Employees and Agents: The Contractor shall be responsible to the Owner for acts and omissions of the Contractor's employees, subcontractors and their agents and employees, and other persons performing portions of the Work under a contract with the Contractor.
- 3.2.3 Acts Do Not Waive Contractor's Obligation: The Contractor shall not be relieved of obligations to perform the Work in strict accordance with the Contract Documents either by activities or duties of the Owner's Representative or the Inspector in the administration of the Contract, or by tests, inspections, or approvals required or performed by persons other than the Contractor.

3.3 PROSECUTION OF WORK

- 3.3.1 Time of the Essence: It is expressly understood and agreed that the time of beginning, rate of progress, and time of completion of the Work are of the essence. The time for completion of this contract shall be **forty-five (45) calendar days**, commencing from the date shown on the Contractor Notice to Proceed.
- 3.3.2 Owner and Contractor recognize that time is of the essence of the Agreement and that Owner will suffer financial loss if the Work is not completed within the times specified, plus any extensions thereof. They also recognize the delays, expense, and difficulties involved with proving in a legal proceeding the actual loss suffered by Owner if the Work is not completed on time. Accordingly, instead of requiring any such proof, Owner and Contractor agree that Contractor shall pay Owner the sum of **One Thousand Dollars (\$1,000) per day**, as liquidated damages and not as a penalty, for each and every calendar day's delay in finishing the Work in excess of the contract time prescribed herein.
- 3.3.3 Work During Operational Hours: The Facility will be operational during the Work. The Contractor shall not interfere or hinder government center operations. The Contractor shall keep all equipment and materials within designated work areas and out of hallways and doorways. Emergency exit routes shall be maintained at all times.
- 3.3.4 Construction Schedule: The Contractor shall coordinate the final critical path method (CPM) construction schedule with the Owner. The CPM schedule is required to be submitted within five (5) calendar days of issuance of Notice to Proceed. The CPM schedule will be for Owner's information only. Silence or inaction with regard to Contractor's schedule shall not be construed as acquiescence or acceptance of the schedule as being binding on Owner. Contractor's schedule shall provide for the completion date not to exceed nor shall it provide for the completion date earlier than the time limits for completion set forth in the Contract Documents. Float, whether for the entire Project or for specific tasks therein, shall be deemed to be for the benefit of the Owner. The Contractor shall keep the construction schedule current, and shall submit weekly updates to the Owner's Representative and Inspector, if any. The Contractor shall further prepare and keep current a schedule of submittals which is coordinated with the construction schedule, and which allows the Owner reasonable time to review the submittals.

3.4 SUBMITTALS

- 3.4.1 Use of Listed Manufacturers; Review of "Or Equals": Contractor shall utilize only the manufacturer designated in its Proposal for major equipment items listed therein. In accordance with the provisions of Section 3400 of the California Public Contract Code, but subject to Subsection (b) thereof, if requesting approval of an "or equal" product, Contractor shall within two (2) business days following the bid opening

submit data substantiating its request. Failure to submit such substantiating data within two (2) business days following the bid opening shall constitute submission of a non-responsive bid.

3.5 STATE AND FEDERAL LABOR REQUIREMENTS

3.5.1 Hours of Work:

1. Eight (8) hours of labor shall constitute a legal day's work upon all work done hereunder, and it is expressly stipulated that no workman employed at any time by the Contractor, or by any subcontractor under this Contract, upon the Work, shall be required or permitted to work thereon more than eight (8) hours in any one (1) calendar day and/or more than forty (40) hours in any one (1) calendar week except as provided in Section 1815 of the Labor Code of California, and it is further expressly stipulated that for each and every violation of said last named stipulation, said Contractor shall forfeit, as penalty to the said Owner, \$25.00 for each workman employed in the execution of this Contract, or by any subcontractor under this Contract, for each calendar day during which said workman is required or permitted to labor more than eight (8) hours in any one (1) calendar day or more than forty (40) hours in any one (1) calendar week in violation of the provisions of said Labor Code.
2. In accordance with the provisions of Section 1776 of the Labor Code of the State of California, the Contractor, and each subcontractor, shall also keep an accurate record showing the names and actual hours worked for all workers employed by him in connection with the Work contemplated by the Agreement, which record shall be open at all reasonable hours to the inspection of the Owner or its officers or agents, and to the Chief of the Division of Labor Statistics and Law Enforcement or the Department of Industrial Relations, his deputies or agents.

3.5.2 Apprentice Employment:

1. Pursuant to the provisions of Section 1777.5 of the Labor Code as amended, the Contractor or subcontractor employing tradesmen in any apprenticeable occupation shall apply to the joint apprenticeship committee nearest the site of the public works project and which administers the apprenticeship program in that trade for a Certificate of Approval. The certificate will also fix the ratio of apprentices to journeymen that will be used in the performance of the Contract. All requirements and exceptions to those requirements set forth herein for Apprenticeship Employment are contained in Labor Code Section 1777.5 and are available from the applicable Joint Apprenticeship Committee.
2. The Contractor shall make contributions to funds established for the administration of the apprenticeship programs if he employs registered apprentices or journeymen in any apprenticeable trade on such contracts and if other contractors on the public works site are making such contributions.
3. The Contractor and any subcontractor under him shall comply with the requirements of Sections 1777.5 and 1777.6 in the employment of apprentices. Information relative to apprenticeship standards, wage schedules, and other requirements may be obtained from the Director of Industrial Relations, ex officio the Administrator of Apprenticeship, San Francisco, California, or from the Division of Apprenticeship Standards and its branch offices.

3.5.3 Wage Rates:

1. Pursuant to Labor Code Section 1770 et seq., each laborer or mechanic of Contractor or any subcontractor engaged in work on the Project under this Contract shall be paid not less than the hourly wage rate of per diem wages set forth in the prevailing wage rate schedule published by the Director of Industrial Relations regardless of any contractual relationship which may be alleged to exist between Contractor or any subcontractor and such laborers and mechanics.

2. Any laborer or mechanic employed to perform work on the Project under this Contract, which work is not covered by any of the foregoing classifications, shall be paid not less than the prevailing rate of per diem wages specified herein for the classification which most nearly corresponds to the work to be performed by him.
3. The foregoing specified prevailing wage rates are minimum rates only, and the Contractor may pay any wage rate in excess of the applicable rate contained in this Contract.
4. Pursuant to Labor Code Section 1775, the Contractor as a penalty to the Owner shall forfeit \$50.00 for each calendar day, or portion thereof for each worker paid less than prevailing rate established by the Department of Industrial Relations for such work or craft in which such worker is employed. The difference between such prevailing wage rates and the amount paid to each worker for each calendar day or portion thereof for which the worker was paid less than the prevailing wage rate shall be paid to each worker by the Contractor.
5. An error on the part of an awarding body does not relieve the Contractor from responsibility for payment of the prevailing rate of per diem wages and penalties pursuant to Labor Code Sections 1770 - 1775.
6. All Contractors and subcontractors are subject to the provisions of Sections 1810-1814 of the California Labor Code which provide that the maximum hours a worker is to be employed is limited to eight (8) hours a day and forty (40) hours a week and the Contractor or subcontractor shall forfeit, as a penalty, \$25.00 for each worker employed in the execution of the Contract for each calendar day during which a worker is required or permitted to labor more than eight (8) hours in any calendar day or more than forty (40) hours in any calendar week and is not paid overtime.
7. Section 1815 of the California Labor Code requires that notwithstanding the provisions of Sections 1810-1814, employees of Contractors who work in excess of eight (8) hours per day and forty (40) hours per week shall be compensated for all hours worked in excess of eight (8) hours per day at not less than 1-1/2 times the basic rate of pay.
8. In the case of federally funded projects, where federal and state prevailing wage requirements apply, compliance with both is required. This project is funded in whole or part by federal funds. Contractor's attention is directed to the requirements of, and compliance with the Copeland Act (18 U.S.C. 874 and 29 CFR Part 3), the Davis-Bacon Act (40 U.S.C. 276a to 276a-7 and 29 CFR Part 5), and the Contract Work Hours and Safety Standards Act (40 U.S.C. 327-330 and 29 CFR Part 5).
9. If there is a difference between the minimum wage rates predetermined by the Secretary of Labor and the general prevailing wage rates determined by the Director of the California Department of Industrial Relations for similar classifications of labor, Contractor and subcontractors shall pay not less than the higher wage rate. The Department will not accept lower State wage rates not specifically included in the Federal minimum wage determinations. This includes "helper" (or other classifications based on hours of experience) or any other classification not appearing in the Federal wage determinations. Where Federal wage determinations do not contain the State wage rate determination otherwise available for use by Contractor and subcontractors, Contractor and subcontractors shall pay not less than the federal minimum wage rate which most closely approximates the duties of the employees in question.
10. Interested parties can obtain the current wage information by submitting requests to the Department of Industrial Relations, Division of Labor Statistics and Research, PO Box 420603, San Francisco CA 94142-0603, Telephone (415) 703-4708 or by referring to the website at <http://www.dir.ca.gov/dlsr/PWD>. The rates at the time of the bid advertisement date of a project will remain in effect for the life of the project in accordance with the California Code of Regulations, as modified and effective January 27, 1997.

11. Copies of the applicable state prevailing wage rates are on file with the County of El Dorado, Chief Administrative Office, Facilities Division, 3000 Fairlane Court, Placerville, CA 95667, and they are available to any interested party on request.

3.5.4 Certified Payroll: As required under the provisions of Labor Code Section 1776 Contractor and subcontractors shall keep accurate payroll records:

1. The payroll records shall show the name, address, social security number, work classification, straight time and overtime hours worked each day and week, and the actual per diem wages paid to each journeyman, apprentice, worker, or other employee by him or her in connection with the Project.
2. A certified copy of all payroll records enumerated above shall be available for inspection at all reasonable hours at the principal office of the Contractor as follows:
 - a. Make available or furnish to the employee or his or her authorized representative on request.
 - b. Make available for inspection or furnished upon request to a representative of the Owner, the Division of Labor Standards Enforcement, and the Division of Apprenticeship Standards of the Department of Industrial Relations.
 - c. Make available upon request by the public for inspection or copies thereof made; provided, however, that a request by the public shall be made through either the Owner, the Division of Labor Standards Enforcement, or the Division of Apprenticeship Standards. The requesting party shall, prior to being provided the records, reimburse the costs of preparation by the Contractor, subcontractor, and the entity through which the request was made. The public shall not be given access to the records at the principal office of the Contractor.

3.5.5 Discrimination In Employment: No discrimination shall occur in the employment of persons upon the Work because of race, color, sex, national origin, or ancestry or religion of such persons.

3.5.6 Convict-Made Materials: Except as may be provided by law, the Contractor agrees that no materials manufactured or produced in a penal or correctional institution shall be incorporated in the construction under this Contract.

3.6 TAXES

3.6.1 Contractor Pays Taxes: The Contractor and subcontractors shall pay all local, state, and federal taxes upon labor or materials involved in their branch of the Work, cost of same to be included in the Contract price.

3.7 COMPLIANCE WITH LAW AND LOCAL REQUIREMENTS

3.7.1 Regulations: The Contractor and all subcontractors shall conform to and abide by all city, county, and state laws, ordinances, rules, and regulations, as the same pertain to the Work contemplated by said Plans and Contract Documents.

3.7.2 Permits, Licenses, and Fees: The County shall procure and pay for all permits and inspection fees that may be required to commence, carry on, and complete the Contract. Contractor shall be responsible for all applicable license fees.

3.7.3 Patent Rights, Copyrights, Trade Names, and Royalties: The Contractor shall indemnify and save harmless the Owner and all persons acting under him for all liability on account of any patent rights, copyrights, or trade names which may affect the articles or materials or their application under the Contract Documents. The Contractor shall pay all royalties, or other charges that may arise, due to methods, types of

construction, processes, materials or use of equipment, and shall hold the Owner harmless from any charges whatsoever which may arise, and shall furnish written assurance, satisfactory to the Owner, that such charges have been paid.

3.8 GUARANTEE

3.8.1 Final Guarantee: The Contractor shall guarantee all materials and equipment furnished and work performed for a period of one (1) year. Contractor warrants and guarantees for a period of one year from the date of the Notice of Acceptance that the Work is free from all defects due to faulty materials or workmanship and Contractor shall promptly make such corrections as may be necessary, including repairs of any damage to other parts of the Work resulting from such defects. Owner will give notice of observed defects with reasonable promptness. In the event that Contractor should fail to make such repairs, adjustments, or other work that may be made necessary by such defects within ten (10) calendar days after being notified in writing by Owner, Owner may do so and charge Contractor the cost thereby incurred.

3.8.2 Extended Guarantees: If a guaranty exceeding one year is provided by the supplier or manufacturer of any equipment used in this Project, then the guarantee for such materials shall be extended for such term. Contractor expressly agrees to act as co-guarantor of such equipment and materials, and Contractor shall supply Owner with all warranty and guaranty documents relative to equipment and materials incorporated in the job and guaranteed by their suppliers or manufacturers.

3.9 WARRANTY

3.9.1 Contract Warranty: The Contractor warrants to the Owner that materials and equipment furnished under the Contract will be of good quality and new, unless otherwise required or permitted by the Contract, that the Work will be free from defects or flaws and is of the highest quality of workmanship and that the Work will conform with the requirements of the Contract. Work not conforming to these requirements, including substitutions not properly approved and authorized, shall be considered defective.

3.10 INDEMNIFICATION

3.10.1 Owner Not Liable for Damages: The Owner or its authorized representative shall not in any way or manner be answerable or suffer loss, damage, expense, or liability for any loss or damage that may happen to said Work, or part thereof, or in or about the same during its construction and before acceptance and the said Contractor shall assume all liabilities of every kind or nature arising from said Work, either by accident, negligence, theft, vandalism, or any cause whatever; and shall hold the Owner and its authorized representatives harmless from all liability of every kind and nature arising from accident, negligence, or any cause whatever, other than for the active negligence of the Owner, its officers, agents and employees.

3.10.2 Owner Not Liable for Debts: Indebtedness incurred for any cause in connection with this Work must be paid by the Contractor, and the Owner is hereby relieved at all times from any indebtedness or claim other than the Contract price.

3.10.3 Indemnity: To the fullest extent allowed by law, Contractor shall defend, indemnify, and hold the County and its officers, directors, and employees, harmless against and from any and all claims, suits, losses, damages, and liability for damages, including attorney's fees and other costs of defense brought for or on account of injuries to or death of any person, including but not limited to, workers and the public, or on account of injuries to or death of County employees or damage to property, or any economic, consequential or special damages which are claimed or which shall in any way arise out of or be connected with Contractor's services, operations or performance hereunder, regardless of the existence or degree of fault or negligence on the part of the County, the Contractor, subcontractors or employees of any of these, except

for the active, or sole negligence of the County its officers and employees, or where expressly prescribed by statute.

The duty to indemnify and hold harmless the County specifically includes the duties to defend set forth in Section 2778 of the Civil Code. The insurance obligations of Contractor are separate, independent obligations under the Contract Documents, and the provisions of this defense and indemnity are not intended to modify nor should they be construed as modifying or in any way limiting the insurance obligations set forth in the Contract Documents.

3.10.4 Environmental Indemnification: To the fullest extent allowed by law, from and after recording of the Notice of Acceptance, Contractor shall indemnify, defend, and save harmless Owner from all losses or damages resulting from injury to or death of any person and damage to property, and any fine, which is occasioned by or arises out of any breach of Environmental and Toxics Warranty, representations, or covenants of Contractor under this Contract. Contractor further agrees to indemnify and hold harmless Owner, its officers, employees, and agents, from and against any and all liability as follows:

1. Including all foreseeable and all unforeseeable consequential damages, directly or indirectly arising out of the use, generation, storage, or disposal of hazardous materials in any location by Contractor, and
2. Including, without limitation, the cost of any required or necessary repair, cleanup, or detoxification and the preparation of any closure or other required plans, whether such action is required or necessary prior to or following filing of the Notice of Acceptance to the full extent that such action is attributable, directly or indirectly, to the presence or use, generation, storage, release, threatened release, or disposal of hazardous materials by any person on the Project prior to filing of the Notice of Acceptance. Contractor's obligations pursuant to the foregoing indemnity shall survive the filing of the Notice of Acceptance of the Project.
3. This agreement as to indemnity and reimbursement as above set forth to be undertaken by the Contractor shall survive the performance of the remainder of said Contract and shall remain in full force and effect notwithstanding such performance.
4. The foregoing duties of indemnity shall not apply to loss, damage, expense, or liability caused solely by the active negligence of the Owner or the Owner's agents, servants or independent contractors.

3.11 WORK REQUIREMENTS

3.11.1 Conduct of Work: The Contractor shall confine the storage of his equipment and materials to limits as designated. He shall at all times exercise due caution and provide all necessary barricades and other safety equipment around the Work to protect the general public from injury to person and property during the entire time of performance of the Work. The Contractor shall not create excessive dust or noise.

3.11.2 Maintenance of Site: Strict prohibition against committing nuisances in or about the Work shall be maintained, and the Contractor shall not in any way obstruct or interfere with movements of traffic on any public right of way without first obtaining the necessary approval of the proper public agency.

3.11.3 Clean Up of Site: The Contractor shall keep the premises and surrounding area free from accumulation of waste materials or rubbish caused by operations under the Contract. At completion of the Work the Contractor shall remove from and about the Project waste materials, rubbish, the Contractor's tools, construction equipment, machinery, and surplus materials. If the Contractor fails to clean up as provided in the Contract Documents, the Owner may do so and the cost thereof shall be charged to the Contractor.

3.11.4 Cutting and Patching:

1. The Contractor shall be responsible for cutting, fitting, or patching required to complete the Work or to make its parts fit together properly.
2. The Contractor shall not damage or endanger a portion of the Work or fully or partially completed construction of the Owner or separate contractors by cutting, patching, or otherwise altering such construction, or by excavation. The Contractor shall not cut or otherwise alter such construction by the Owner or a separate contractor except with written consent of the Owner and of such separate contractor; such consent shall not be unreasonably withheld. The Contractor shall not unreasonably withhold from the Owner or a separate contractor the Contractor's consent to cutting or otherwise altering the Work.

3.12 SUBCONTRACTORS

3.12.1 Contractor Responsible for Subcontractor's Acts: Contractor shall be fully responsible to Owner for the acts and omissions of his subcontractors, and of persons either directly or indirectly employed by them, as he is for the acts and omissions of persons directly employed by him.

3.12.2 Contractor's Subcontract: Contractor shall cause appropriate provisions to be inserted in all subcontracts relative to the Work to bind subcontractors to Contractor by the terms of the Contract Documents insofar as applicable to the Work of subcontractors and to give Contractor the same power as regards terminating any subcontract that Owner may exercise over Contractor under any provisions of the Contract Documents. The percentage of retention withheld from any subcontractor by the Contractor shall not exceed the percentage of retention withheld from the Contractor as provided herein.

3.12.3 Ineligible Subcontractor: Contractor is prohibited from performing work with a subcontractor who is ineligible to perform work pursuant to Labor Code Section 1777.1 or 1777.7.

3.13 SUPERINTENDENT

3.13.1 Work Superintendent: The Contractor will employ and maintain on the worksite a qualified supervisor or Superintendent who shall have been designated in writing by the Contractor as the Contractor's representative at the site. The Superintendent shall have full authority to act on behalf of the Contractor, and all communications given to the Superintendent shall be as binding as if given to the Contractor. The Superintendent shall be present on the site at all times as required to perform adequate supervision and coordination of the Work.

3.14 LABOR AND MATERIALS

3.14.1 Skilled Labor: All labor must be especially skilled for each kind of work, and must be thorough and first class in all respects. Any person whom the Inspector or Owner may deem incompetent or disorderly shall be promptly discharged from the Project and not re-employed.

3.14.2 Quality of Materials: All materials used on this Contract shall be new and the best market quality, unless specified or shown otherwise. All Work executed under this Contract shall be done in the best, most thorough, substantial and workmanlike manner and without flaws. All materials and labor shall be subject to the approval of the Inspector as to its quality and fitness, and shall be immediately removed if it does not meet with his approval. The Inspector may refuse to issue the Certificate for Payment until all defective materials or work have been removed and other material of proper quality substituted therefore. All removal and replacement with same shall be done at the Contractor's expense. Manufactured articles,

materials, and equipment shall be applied, installed, connected, erected, used, cleaned, and conditioned as directed by the manufacturer.

ARTICLE 4

ADMINISTRATION OF CONTRACT

4.1 ADMINISTRATION OF CONTRACT

4.1.1 Contract Communications: Unless otherwise provided in the Contract or when direct communications have specifically been authorized, all parties shall communicate through the Owner's Representative or the Inspector if the Owner so directs. Communications by and with the subcontractors and material suppliers shall be through the Contractor. Communications by Contractor to separate contractors, architect, or Project Manager shall be through the Owner's Representative.

4.1.2 Control of Work: The Owner's Representative or the Inspector will not have control over or charge of and will not be responsible for construction means, methods, techniques, sequences or procedures, or for safety precautions and programs in connection with the Work, since these are solely the Contractor's responsibility. The Owner's Representative or the Inspector will not be responsible for the Contractor's failure to carry out the Work in accordance with the Contract Documents. The Owner's Representative or the Inspector will not have control over or charge of and will not be responsible for acts or omissions of the Contractor, subcontractors, or their agents or employees, or of any other persons performing portions of the Work.

4.1.3 Recommendation for Payments: Based on his or her observations and evaluations of the Contractor's Applications for Payment, the Owner's Representative will review amounts due the Contractor and will recommend to Owner, payments to Contractor as set forth in the section entitled CERTIFICATION FOR PAYMENTS.

4.1.4 Inspector's Authority: The Inspector will have the authority to stop work whenever necessary to ensure a proper execution of the Work. The Inspector will also have authority to reject Work which does not conform to the Contract Documents. Whenever the Inspector considers it necessary or advisable for implementation of the intent of the Contract Documents, the Inspector will have authority to require additional inspection or testing of the Work in accordance with the following section whether or not such Work is fabricated, installed, or completed. However, neither this authority of the Inspector nor a decision made in good faith either to exercise or not to exercise such authority shall give rise to a duty or responsibility of the Inspector to the Contractor, subcontractors, material and equipment suppliers, their agents or employees, or other persons performing portions of the Work. In the event an Inspector is not appointed by the Owner, the Owner's Representative shall have the authority set forth herein.

4.2 INSPECTION AND TESTING

4.2.1 Advance Notice: Contractor shall provide Owner's Representative seventy-two (72) hours notice prior to beginning work at a specific location and for a specific department. Contractor shall notify Owner's Representative and Inspector forty-eight (48) hours prior to any day in which Contractor will 1) require an inspection of any portion of the Work, 2) work in excess of eight (8) hours or any time Contractor intends to work weekends, and 3) require shut down of all or any portion of building systems (electrical, plumbing, fire, mechanical, etc.). Any work not performed subject to inspection will not be accepted and will be rejected and/ or ordered removed by Owner, or Inspector.

4.2.2 Access to Work: The Owner's Representative, the Architect, the Project Manager, and the Inspector will at all times have access to the Work. In addition, authorized representatives and agents of any participating Federal or State Agency shall be permitted to inspect all Work, materials, payrolls, and records on

personnel, invoices of materials, and other relevant data and records. The Contractor will provide proper facilities for such access and observation of the Work and also for any inspection or testing thereof.

4.2.3 Costs of Tests: The Owner shall bear all costs related to testing for conformance of the Work to the Contract requirements. However, if the Contractor has called for any testing, and that test fails, subsequent tests, and all related costs, shall be borne by the Contractor.

4.2.4 Preparation of Change Directives/Orders: The Owner's Representative or the Inspector, if one is appointed, will prepare Change Orders and Construction Change Directives, and may authorize minor changes in the Work as provided in the section entitled CHANGES IN WORK.

4.3 CLAIMS

4.3.1 Concealed or Unforeseen Conditions: It is understood by both parties that Contractor has made a pre-contract investigation of the site. All concealed, unforeseen, or materially differing conditions are the responsibility of the Contractor in the absence of an actual material, intentional misrepresentation by the Owner as to the conditions on the site. Contractor shall give written notice of any conditions encountered at the site which are unforeseen, concealed, or materially different from those set forth in the Plans or Contract Documents, or ordinarily encountered and generally recognized as inherent in the Work. Such written notice shall be given within five (5) calendar days of his discovery of any such facts.

4.3.2 Notice of Discovery of Hazardous Waste or Unusual Conditions:

1. The Contractor shall promptly, and before the following conditions are disturbed, notify the Owner in writing, in the event the Contractor encounters any of the following:
 - a. Material that the Contractor believes may be hazardous waste, as defined in Section 25117 of the Health and Safety Code that is required to be removed to a Class I, Class II, or Class III disposal site in accordance with provisions of existing law.
 - b. Unknown physical conditions at the site of any unusual nature, different materially from those ordinarily encountered and generally recognized as inherent in the work of the character provided for in the contract.
2. The Owner shall promptly investigate the conditions, and if it finds that the conditions do materially so differ, or do involve hazardous waste, or cause a decrease or increase in the Contractor's cost of, or time required for, performance of any part of the work shall issue a change order under the procedures described herein.
3. In the event a dispute arises between the Owner and the Contractor whether the conditions materially differ, or involve hazardous waste, or cause a decrease or increase in the Contractor's cost of, or time required for, performance of any part of the work, the Contractor shall not be excused from any scheduled completion date provided for in the contract, but shall proceed with all work to be performed under the Contract. The Contractor shall retain any and all rights provided either by contract or by law which pertain to the resolution of disputes and protests between the Contractor and the Owner.

4.3.3 Time Limits on Claims: Claims by Contractor must be made within ten (10) calendar-days after occurrence of the event giving rise to such Claim, except that claims made due to delay or hindrances which Contractor claims was caused by Owner shall be made within five (5) calendar-days after occurrence of the event giving rise to such Claim. Claims must be made by written notice. Failure to make such claim in writing in the time set forth herein shall bar Contractor from recourse for such claim. All claims must be filed on or before the payment date of Final Payment.

4.3.4 Claims for Additional Costs:

1. If Contractor wishes to make a Claim for an increase in the Contract Price, he shall give the Owner written notice thereof within the time set forth in Paragraph 4.3.3. This notice shall be given by the Contractor before proceeding to execute the work, except in an emergency endangering life or property in which case the Contractor shall, as soon as possible, advise Owner of his intent to do the Work.
2. Increases in Contract Price due to Claims shall be calculated based on the Cost Reimbursement method detailed in Paragraph 5.4.1.3.
3. Under no circumstances shall Contractor recover any administrative overhead costs or recover on the basis of any "Home Office" damages formula, "Total Cost" recovery formula, or any other such formula.

4.3.5 Claims for Additional Time:

1. If the Contractor wishes to make Claim for an increase in the Contract Time, written notice as provided herein shall be given. The Contractor's Claim shall include an estimate probable effect of delay on progress of the Work.
2. If adverse weather conditions are the basis for a Claim for additional time, such Claim shall be documented by data substantiating that weather conditions were abnormal for the period of time and could not have been reasonably anticipated, and that weather conditions had an adverse effect on the scheduled construction.
3. The Owner shall not be liable for any damages on account of any reasonable delay or hindrance of the Owner. However, Contractor shall be entitled to an extension of time for any delay or hindrance caused by the Owner. Any delay or hindrance by Owner which is unreasonable and not within the contemplation of the parties may subject Owner to a claim for damages. Contractor shall make any claims in writing within the time set forth in Paragraph 4.3.3., for any unreasonable delay or hindrance caused by Owner, and specifying the cause thereof as required in paragraph "Submittal of Claims".

4.3.6 Submittal of Claims: Any disputes relating to this Contract, or its breach, which is not disposed of by agreement shall be promptly submitted as a claim to the Owner's Representative who shall issue a written response on the dispute. Claims shall be submitted by the Contractor to the Owner's Representative with adequate supporting data and include a demand for the Owner's Representative's decision. Adequate supporting data shall include, but is not limited to, a statement of the reasons for the asserted entitlement, the certified payroll, invoice for material and equipment rental, and an itemized breakdown of any adjustment sought. The claim must be sent by registered mail or certified mail with return receipt requested to Owner's Representative.

4.3.7 Submission Under Penalty of Perjury: The Contractor shall certify, at the time of submission of a claim, as follows:

"I certify under penalty of perjury under the laws of the State of California, that the claim is made in good faith, that the supporting data are accurate and complete, and that the amount requested accurately reflects the contract adjustment for which the Owner is liable.

By: _____
“(Contractor's signature)”

4.3.8 Third Party Claims: Owner will notify Contractor of receipt of any third party claim relating to the contract within five (5) calendar days of receipt of such claim.

4.4 DISPUTE RESOLUTION

4.4.1 Continue Work During Dispute: In the event of any dispute between the Owner and the Contractor, the Contractor will not stop Work but will prosecute the work diligently to completion in the manner directed by the Owner, and the dispute shall be resolved as set forth herein after completion of the Work.

4.4.2 Requirements for Filing a Claim: The claim shall be in writing and include documents necessary to substantiate the claim. Claims must be filed on or before the date of final payment. Claims must be submitted by registered mail or certified mail with return receipt requested to Owner's Representative.

4.4.3 Owner's Review of Claim.

(a) Upon receipt of a claim, the Owner's Representative shall conduct a reasonable review of the claim, and within a period not to exceed forty-five (45) days, shall provide the Contractor a written statement identifying what portion of the claim is disputed and what portion is undisputed.

(b) The County and Contractor may, by mutual agreement, extend the time period provided in this Article 4.4.

(c) If the County needs approval from the Board of Supervisors to provide the Contractor a written statement identifying the disputed portion and the undisputed portion of the claim, and the Board does not meet within the forty-five (45) days or within the mutually agreed to extension of time following receipt of a claim sent by registered mail or certified mail, return receipt requested, the County shall have up to three (3) days following the next duly publicly noticed meeting of the governing body after the forty-five (45) day period, or extension, expires to provide the Contractor a written statement identifying the disputed portion and the undisputed portion.

(d) Any payment due on an undisputed portion of the claim shall be processed and made within sixty (60) days after the County issues its written statement. Failure by the County to issue a written statement shall result in the claim being deemed rejected in its entirety. A claim that is denied by reason of the County's failure to have responded to a claim, or its failure to otherwise meet the time requirements of this Article 4.4, shall not constitute an adverse finding with regard to the merits of the claim or the responsibility or qualifications of the Contractor.

(e) If the Contractor disputes the County's written response, or if the County fails to respond to a claim issued pursuant to this Article within the time prescribed, the Contractor may demand in writing an informal conference to meet and confer for settlement of the issues in dispute. Upon receipt of a demand in writing sent by registered mail or certified mail, return receipt requested, the County shall schedule a meet and confer conference within thirty (30) days for settlement of the dispute.

(f) Within ten (10) business days following the conclusion of the meet and confer conference, if the claim or any portion of the claim remains in dispute, the County shall provide the Contractor a written statement identifying the portion of the claim that remains in dispute and the portion that is undisputed. Any payment due on an undisputed portion of the claim shall be processed and made within sixty (60) days after the County issues its written statement.

4.4.4 Nonbinding Mediation

(a) Any disputed portion of the claim, as identified by the Contractor in writing, shall be submitted to nonbinding mediation, with the County and the Contractor sharing the associated costs equally. The County and Contractor shall mutually agree to a mediator within ten (10) business days after the disputed portion of the claim has been identified in writing. If the parties cannot agree upon a mediator, each party shall select a mediator and those mediators shall select a qualified neutral third party to mediate with regard to the disputed portion of the claim. Each party shall bear the fees and costs charged by its respective mediator in connection with the selection of

the neutral mediator. If mediation is unsuccessful, the parts of the claim remaining in dispute shall be subject to applicable procedures outside this section.

- (b) For purposes of this section, mediation includes any nonbinding process, including, but not limited to, neutral evaluation or a dispute review board, in which an independent third party or board assists the parties in dispute resolution through negotiation or by issuance of an evaluation. Any mediation utilized shall conform to the timeframes in this Article 4.4.
- (c) Unless otherwise agreed to by the County and the Contractor in writing, the mediation conducted pursuant to this section shall excuse any further obligation under Section 20104.4 to mediate after litigation has been commenced.
- (d) If mediation is unsuccessful, the part of the claim remaining in dispute shall be subject to applicable procedures outside of this Article 4.4.
- (e) The claim resolution procedures in this Article 4.4 do not preclude the County from requiring arbitration of disputes under private arbitration or the Public Works Contract Arbitration Program, if mediation under this Article does not resolve the parties' dispute.

4.4.5 Payment of Undisputed Portion of Claim: Amounts not paid in a timely manner as required by this Article 4.4 shall bear interest at 7 percent (7%) per annum.

4.4.6 Claims by Subcontractors: If a subcontractor or a lower tier subcontractor lacks legal standing to assert a claim against County because privity of contract does not exist, Contractor may present to the County a claim on behalf of a subcontractor or lower tier subcontractor. A subcontractor may request in writing, either on their own behalf or on behalf of a lower tier subcontractor, that the Contractor present a claim for work which was performed by the subcontractor or by a lower tier subcontractor on behalf of the subcontractor. The subcontractor requesting that the claim be presented to the County shall furnish reasonable documentation to support the claim. Within forty-five (45) days of receipt of this written request, the Contractor shall notify the subcontractor in writing as to whether the Contractor presented the claim to the County and, if the original Contractor did not present the claim, provide the subcontractor with a statement of the reasons for not having done so.

4.4.7 Compliance.

- (a) The provisions of this Article constitute a non-judicial dispute resolution procedure that, pursuant to Section 930.2 of the California Government Code, shall constitute a condition precedent to submission of a valid claim under the California Government Code. Contractor shall bear all costs incurred in the preparation, submission and administration of a claim. Any claims presented in accordance with the Government Code must affirmatively indicate Contractor's prior compliance with the dispute resolution procedure herein and the previous dispositions of the claims asserted. Pursuant to Government Code Section 930.2, the one (1) year period in Government Code Section 911.2 shall be reduced to one hundred and fifty (150) days from either accrual of the cause of action, substantial completion or termination of the contract, whichever occurs first; in all other respects, the Government Code shall apply unchanged.
- (b) Failure to submit a claim as required in Article 4.3 shall waive Contractor's right to claim on any specific issues not included in a timely submitted claim or issues not raised in a timely protest and timely claim submitted under Article 4.3 and may not be asserted in any subsequent litigation, Government Code claim, or legal action.
- (c) Upon receipt of a claim, the parties may mutually agree to waive, in writing, mediation and proceed directly to the commencement of a civil action or binding arbitration, as applicable; and County may prescribe reasonable change order, claim, and dispute resolution procedures and requirements in addition to the provisions of this Article 4.4, so long as the provision do not conflict with or otherwise impair the timeframes and procedures set forth in this section.

4.4.8 Consistency with Public Contract Code Sections 9204 and 20104 et seq: If Contractor remains dissatisfied and desires to preserve its right to pursue the matter further, Contractor must file a claim with the County pursuant to Government Code Sections 900 et seq. or Sections 910 et seq. If any claim arising under this Contract is subject to the provisions of Public Contract Code Sections 9204 or 20104 et seq. and if those provisions require a procedure different from that established in this Contract, then the provisions of those sections shall apply in place of the conflicting procedure established herein.

ARTICLE 5

CHANGES IN WORK

5.1 WAIVER

5.1.1 Waivers of Contract Provisions: It is expressly understood and agreed that no waiver granted by the Inspector or the Owner of any term, provision, or covenant of this Contract shall constitute a precedent for breach of the same or any other terms, provisions, or covenants of this Contract.

5.2 CHANGES

5.2.1 Owner May Order Changes in Work: The Contractor agrees that the Owner, without invalidating the Contract, may order changes in Work by altering, adding to, or deducting from the Work, the Contract Amount and Time being adjusted according to the provisions of Section 5.4 and Section 5.5. Contractor agrees to enter into a modification of his original Contract for such changes.

5.2.2 Cost Proposals: Upon request of the Owner for a quotation on the change to the Work, the Contractor shall promptly submit to Owner's Representative, and the Inspector, if one is appointed, in writing a detailed breakdown of the work and of the amount of deduction or addition claimed. In no case shall Cost Proposals be provided later than ten (10) calendar days from the date requested. The Owner's request for quotations on alterations to the Work shall not be considered authorization to proceed with the work prior to issuance of a Change Order, nor shall such request justify any delay in existing work. If Contractor fails to provide Cost Proposals within ten (10) calendar days, Owner may prepare the Cost Proposal based on estimates of labor, materials, and equipment. This proposal, prepared by Owner, shall be binding on the Contractor, will become the basis for Contract Price adjustment, and shall not be subject to dispute or claim.

5.2.3 Contract Change Instrument: Changes in work involving a change in Contract Price or Contract Time shall be done only pursuant to an Architect's Supplemental Instructions (if applicable), Change Order, or Construction Change Directive as set forth below in this article.

5.2.4 Changes Shall Conform to Contract: Changes in work shall be performed in conformance with applicable provisions of the Contract Documents, and the Contractor shall proceed promptly unless otherwise provided in the Architect's Supplemental Instructions (if applicable), Change Order, or Change Directive.

5.3 CONTRACT CHANGE INSTRUMENTS

5.3.1 Architect's Supplemental Instructions (ASI) (if applicable): The Owner's Representative or the Architect, may order minor changes in work by use of an Architect's Supplemental Instruction. These minor changes will involve neither changes in the Contract Price or Contract Time. If the Contractor disagrees that the change does not involve a change in cost or time, then a Change Order or Change Directive shall be used.

5.3.2 **Change Order (CO):** The Change Order shall be used in cases where Owner and Contractor agree on the change in work, the amount of or method of computing the Contract Amount, and the amount of adjustment in Contract Time.

5.3.3 **Construction Change Directive (CCD):** In the event that the Owner and Contractor do not agree on the proposed change in work, and/or the proposed adjustment of Contract Price and Time, or in the event it is essential that the Contractor proceed expeditiously and without delay, then Owner may, by issuance of a Construction Change Directive, order changes in work, and the Contractor shall promptly proceed with the change in work involved.

1. **Acceptance of Change Directive:** If Contractor agrees with the Change Directive, the Contractor shall by his signature thereon, indicate his acceptance of the terms of the Directive, including adjustments to price and time, and the Change Directive shall then be followed by a Change Order.
2. **Non-Acceptance of Change Directive:** If the Contractor disagrees with the method of computing an increase in Contract Price, then the amount of adjustment shall be computed by the Cost Reimbursement method detailed in Basis for Adjustment. Disagreements with amounts or credits, under the Cost Reimbursement method, or time, shall be considered a dispute, and processed under the section on Disputes Resolution.

5.4 BASIS OF ADJUSTMENT

5.4.1 **Methods of Adjustment:** The amount of adjustments to Contract Price, whether a credit or payment, shall be computed by one of the methods detailed below. The method used shall be at the sole determination of the Owner.

1. **Unit Prices:** Those prices stipulated in the Bid Proposal shall be utilized where they are applicable. In the event the change in original quantity is in excess of twenty five (25) percent of the original bid quantity, and the total dollar value of that bid is greater than \$5,000, the Owner shall review the unit price to determine if a new unit price shall be renegotiated. Unit prices for new items shall be negotiated and mutually agreed upon.
2. **Lump Sum:** A total lump sum for the Work negotiated and mutually acceptable to the Contractor and Owner. Lump sum quotations for modifications to the Work shall include substantiating documentation with an itemized breakdown of Contractor's and subcontractor's costs, including labor, materials, rentals, approved services, overhead, and profit all calculated as specified in the Cost Reimbursement method which follows.
3. **Cost Reimbursement (Extra Work):** In this method, the payment for Extra Work shall be made on a time and expense basis that is on an accounting of the Contractor's forces, materials, equipment, and other items of cost as required and used to do the Work. Payment will be made for the documented actual cost of the following:
 - a. Costs of direct labor, excluding supervisory personnel, including social security, old age and unemployment insurance, fringe benefits required by agreement, labor insurance and labor taxes established by law.
 - b. Costs of materials, supplies, and equipment, including cost of transportation and sales tax, whether incorporated if paid for by the Contractor or his subcontractor.
 - c. Rental costs, prevailing in the area, of machinery and equipment for the actual time used, and including transportation costs for items having value in excess of \$100.00.

- d. Costs of premiums for all bonds and insurance, permit fees, and sales, use or similar taxes related to the Work.

To the above cost the Contractor shall be allowed a markup of fifteen (15) percent on direct labor charges and fifteen (15) percent for all other cost items. When any or all of the Extra Work is done by one of the Contractor's subcontractors, the markups set forth above shall be applied to the subcontractor's actual costs to which a five (5) percent markup shall be allowed the Contractor. These markups shall be considered to be full compensation, covering the cost of general supervision, administration, overhead, profit, and any and all other general expenses, including, but not limited to, uniforms, hand tools, safety equipment, travel and lodging.

5.5 EXTENSION OF TIME FOR COMPLETION

- 5.5.1 Contractor Delayed or Hindered: Should the Contractor be delayed or hindered in the completion of the Work by the neglect of the Owner, or by fire, by strikes, lockouts, embargoes or earthquakes, and any other causes the Inspector approves as not having been reasonably foreseeable at the time of execution of the Contract Documents, then the time allowance herein fixed for the completion of the Work shall be extended for a period equivalent to the time lost by reason of any or all of the causes aforesaid. Time extensions must be requested in accordance with Section 4.3.
- 5.5.2 Agreement on Time Extension: In addition, the Contractor and the Owner reserve the right to mutually agree in writing upon an extension of time for completion for causes other than enumerated above.
- 5.5.3 Time Extension Not Waiver: The granting of an extension of time by the Owner for performance by the Contractor shall not operate as a waiver or stop the Owner from claiming damages due to any other delays, prior or subsequent, which were not approved by the Owner as provided herein.

ARTICLE 6

PAYMENTS AND COMPLETION

6.1 GENERAL

- 6.1.1 Contract Price: The Contract Price stated in the Contract is the total amount payable by the Owner to the Contractor for performance of the Work under the Contract Documents.
- 6.1.2 Waiver: Neither the acceptance of the Work by the Owner nor the payment of any part or all of the sum due the Contractor hereunder shall constitute a waiver by the Owner of any claim which the Owner may have against the Contractor or Surety under this Contract or otherwise.
- 6.1.3 Manner of Paying Warrants: Payment becomes due under the terms of this Contract in the manner prescribed by law. The Auditor shall cause a warrant for the Certified amount to be drawn upon the proper fund of the Treasurer of the Owner, which warrant shall be approved and issued to Contractor within that period of time customarily required to process said warrants in the ordinary course of Owner's business.

6.2 APPLICATIONS FOR PAYMENT

- 6.2.1 Submittal of Applications: The Contractor shall submit to the Owner OR Owner's Representative, an Application for Payment form, which will be provided by the Owner. Such application shall be supported by such data substantiating the Contractor's right to payment as the Owner may require, such as copies of requisitions from subcontractors and material suppliers.

6.2.2 **Basis for Payment:** The Payment shall be based upon the total Contract price and upon percentage of completion of the Work at the time of the submittal of the application for payment.

6.2.3 Before submitting an Application for Payment (Final or Partial) the Contractor shall reach an agreement with the Project Manager concerning the percentage complete of the Work and the dollar value for which the Application for Payment may be submitted.

6.2.4 **Work Free of Liens:** The Contractor warrants that upon submittal of an Application for Payment, all work for which Certificates for Payment have been previously issued and payments received from the Owner shall be free and clear of liens, claims, security interests, or encumbrances against Contractor by subcontractors, material suppliers, or other persons or entities making a claim by reason of having provided labor, materials, and equipment in relation to the Work.

6.3 CERTIFICATION FOR PAYMENT

6.3.1 **Certification Determination:** The Owner's Representative will review as soon as practicable for the purpose of determining whether it is a proper payment request and shall within seven (7) days after receipt of the Contractor's Application for Payment, either issue to the Owner a Certification for Payment, with a copy to the Contractor, for such amount as determined to be properly due, or notify the Contractor of the reasons why the payment request is not proper and for withholding certification of payment in whole or in part as provided in Section 6.4.1.

6.3.2 The Owner shall pay or cause to be paid to Contractor, an amount equal to ninety five percent (95%) as noted in Section 6.4.3 of the amount set forth in the approved Certificate for Payment within thirty (30) days of receipt of an Application for Payment approved by the Owner's representative as provided for in Paragraph 6.3.1 above, and shall retain the remaining five percent (5%) as noted in 6.4.3 until the time provided for in Section 6.6.4. The Owner shall withhold amounts pursuant to stop notices received in addition to the retainage. Failure of Owner to make payments provided herein in a timely manner shall not constitute a default by the Owner of the Contract, but may entitle the Contractor to interest as provided by law.

6.4 WITHHOLDING FROM PAYMENTS

6.4.1 **Reasons for Withholding:** The Owner, upon recommendation of the Inspector, may withhold payments, or on account of subsequently discovered evidence nullify the whole or a part of any progress or retention payments to such extent as may be necessary to protect the Owner from loss on account of:

1. Defective work or material not remedied or replaced.
2. The filing of claims or Stop Notices to withhold, or reasonable evidence indicating probable filing of such claims or notices.
3. Failure of the Contractor to make payments properly to subcontractors, or for materials or labor.
4. Failure to make payments to any person or entity for financial obligations of the Contractor under terms of this Contract.
5. A reasonable doubt that the Contract can be completed for the balance then unpaid.
6. Damage to another contractor.
7. Performance of work in violation of the terms of the Contract Documents.

8. Excessive costs to Owner.

9. Failure of Contractor to comply with requirements for timely submittal of specified documentation, including but not limited to construction schedules, cost proposals, and submittals.

6.4.2 Release of Payment: When the above grounds for withholding are removed, payment shall be made for amounts withheld because of them.

6.4.3 Method of Retainage: The Department will retain 5% of the value of each progress payment from each progress payment. The retained funds shall be retained until thirty-five (35) days after recordation of the Notice of Acceptance.

6.5 SUBSTITUTE SECURITIES FOR RETENTION

6.5.1 Substitution of Securities: Bidders are hereby put on notice that the successful bidder may substitute securities for any monies withheld by the County of El Dorado to insure performance of the Contract pursuant to Public Contract Section 22300. This section provides that the Contractor may elect to receive 100 percent of payments due under the Contract Documents from time to time, without retention from any portion of the payment by the County of El Dorado, by depositing eligible securities of equivalent value with the County of El Dorado or qualified escrow agent in accordance with the provisions of Public Contract Code Section 22300. Eligible securities shall be limited to those listed in Section 16430 of the Government Code, or bank or savings and loan certificates of deposit from a qualified institution. Any such escrow agreement shall follow the form set forth in Public Contract Code Section 22300(f) and provided by the Owner.

6.6 FINAL COMPLETION AND PAYMENT OF RETAINAGE

6.6.1 Affidavit of Payment: After the date of Substantial Completion of the Work, and before final acceptance of the Work, the Contractor shall file with the Owner his affidavit, sworn to before a Notary Public, stating that all workmen and persons employed, all firms supplying materials, and all subcontractors upon the project for either labor or material have been paid in full, except certain items, if any, to be set forth in such affidavit covering disputed claims, including claims for acceleration, disruption, delays, inefficiencies, and hindrance, or items in connection with which Stop Notices have been filed under the provisions of the Statutes of the State of California. The filing of such affidavit by the Contractor shall be one of the prerequisites to the making, by the Owner, of the final retainage payment on the Contract.

6.6.2 Final Inspection: Upon receipt of written notice that the Work is ready for final inspection and acceptance and upon receipt of the Application for Payment, the Owner will promptly make such inspection. The Contractor shall complete all punch list items within two (2) days of receipt of the written punch list. When the Owner's Representative finds the work acceptable under the Contract Documents and the Contract fully performed, the Owner's Representative will promptly recommend to Owner that Owner may consider the Project complete, accept the project, and that the Notice of Acceptance may be issued.

6.6.3 Final Certification: Before issuance of payment, Contractor shall file, with Owner, a certificate in which he certifies that to the best of the Contractor's knowledge, information, and belief, and on the basis of observations and inspections, the Work has been completed in accordance with terms and conditions of the Contract Documents.

6.6.4 Payment of Retention: Thirty-five (35) days after the Notice of Acceptance has been filed, provided the Work is fully completed and the Contract fully performed, the balance due under the Contract shall be paid, less any monies held for stop notices. Payment shall not be construed as an absolute acceptance of the work done up to the time of such payment. The Contractor, if requested by the Owner, shall furnish

receipts or other vouchers showing his payments for materials and labor. Owner may withhold from payment an amount not to exceed 150 percent of any amount in dispute.

6.6.5 Notice of Acceptance: The Work shall be accepted in writing in the form of a Notice of Acceptance when the whole of the work has been completed satisfactorily to the Owner. In judging the Work, no allowance for deviations from the original Contract Documents will be made unless already approved in writing at the proper times and in the manner as called for herein.

ARTICLE 7

PROTECTION OF PERSONS AND PROPERTY

7.1 PROTECTION OF WORK, PROPERTY, AND PERSONS

7.1.1 Responsible for Damage to Owner's Property: The Contractor shall be entirely responsible for any damage to the property of the Owner due to careless handling of tools and/or materials or other causes attributed to the Contractor's Work in performing this Contract.

7.1.2 Responsible for Safety: The Contractor will take all necessary precautions for the safety of, and will provide the necessary protection to prevent damage, injury, or loss to all employees on the Work and other persons who may be affected thereby, all the Work and all materials or equipment to be incorporated therein, whether in storage on or off the site, and other property at the site or adjacent thereto, including trees, shrubs, lawns, walks, pavements, roadways, structures, and utilities not designated for removal, relocation, or replacement in the course of construction.

7.1.3 Safety and Convenience: The Contractor will comply with all applicable laws, ordinances, rules, regulations, and orders of any public body having jurisdiction. The Contractor will erect and maintain, as required by the conditions and progress of the Work, all necessary safeguards for safety and protection. The Contractor will notify owners of adjacent utilities when prosecution of the Work may affect them.

7.1.4 Remedy Damages: The Contractor will remedy all damage, injury, or loss to any property caused, directly or indirectly, in whole or part, by the Contractor, any subcontractor, or anyone directly or indirectly employed by any of them or anyone of whose acts any of them would be liable, except damage or loss attributable to the sole or active negligence of the Owner or the Inspector or anyone employed by them and not attributable, directly or indirectly, in whole or in part, to the fault or negligence of the Contractor.

ARTICLE 8

INSURANCE AND BONDS

8.1 INSURANCE

GENERAL INSURANCE REQUIREMENTS

The Contractor shall provide proof of a policy of insurance satisfactory to the El Dorado County Risk Management Division and documentation evidencing that the Contractor maintains insurance that meets the following requirements:

1. Full Workers' Compensation and Employers' Liability Insurance covering all employees of the Contractor as required by law in the State of California.

2. Commercial General Liability Insurance of not less than Two Million Dollars (\$2,000,000) combined single limit per occurrence for bodily injury and property damage, including but not limited to endorsements for the following coverage: Premises, personal injury, operations, products and completed operations, blanket contractual, and independent contractors liability. This insurance can consist of a minimum \$1 Million primary layer of CGL and the balance as an excess/umbrella layer, but only if the County is provided with written confirmation that the excess/umbrella layer "follows the form" of the CGL policy.
3. Automobile Liability Insurance of not less than One Million Dollars (\$1,000,000) is required in the event motor vehicles are used by the Contractor in performance of the contract.
4. In the event Contractor is a licensed professional and is performing professional services under this contract, Professional Liability Insurance is required with a limit of liability of not less than One Million Dollars (\$1,000,000).
5. Explosion, Collapse and Underground coverage is required when the scope of work includes XCU exposures. For the purpose of this contract, XCU coverage is not required.

PROOF OF INSURANCE REQUIREMENTS

1. Contractor shall furnish proof of coverage satisfactory to the El Dorado County Risk Management Division as evidence that the insurance required herein is being maintained. The insurance will be issued by an insurance company acceptable to the Risk Management Division, or be provided through partial or total self-insurance likewise acceptable to the Risk Management Division.
2. The County of El Dorado, its officers, officials, employees, and volunteers shall be included as additional insureds, but only insofar as the operations under this Contract are concerned. This provision shall apply to all general liability and excess liability policies. Proof that the County is named additional insured shall be made by providing the Risk Management Division with a certified copy, or other acceptable evidence, of an endorsement to Contractor's insurance policy naming the County additional insured.
3. In the event Contractor cannot provide an occurrence policy, Contractor shall provide insurance covering claims made as a result of performance of this contract for not less than three (3) years following completion of performance of this Contract.
4. Any deductibles or self-insured retentions must be declared to and approved by the County. At the option of the County, either: the insurer shall reduce or eliminate such deductibles or self-insured retentions as respects the County, its officers, officials, employees and volunteers; or the Contractor shall procure a bond guaranteeing payment of losses and related investigations, claim administration and defense expenses.
5. Contractor shall require each of its subcontractors to procure and maintain commercial general liability insurance, automobile liability insurance, and workers compensation insurance of the types and in the amounts specified above, or shall insure the activities of its subcontractors in its own policy in like amounts. Contractor shall also require each of its subcontractors to name Contractor and County of El Dorado as additional insureds.

INSURANCE NOTIFICATION REQUIREMENTS

1. Contractor agrees no cancellation or material change in any policy shall become effective except upon thirty (30) days prior written notice to the County of El Dorado, Chief Administrative Office, Facilities Division, Russell Fackrell at 3000 Fairlane Court, Placerville, CA 95667.
2. Contractor agrees that the insurance required herein shall be in effect at all times during the term of this agreement. In the event said insurance coverage expires at any time or times during the term of this Contract, Contractor shall immediately provide a new certificate of insurance as evidence of the required insurance coverage. In the event Contractor fails to keep in effect at all times insurance coverage as herein provided, County may, in addition to any

other remedies it may have, terminate this Contract upon the occurrence of such event. New certificates of insurance are subject to the approval of the Risk Management Division.

ADDITIONAL STANDARDS

Certificates shall meet such additional standards as may be determined by the Department either independently or in consultation with the Risk Management Division, as essential for protection of the County.

COMMENCEMENT OF PERFORMANCE

Contractor shall not commence performance of this Contract unless and until compliance with each and every requirement of the insurance provisions is achieved.

MATERIAL BREACH

Failure of Contractor to maintain the insurance required herein, or to comply with any of the requirements of the insurance provisions, shall constitute a material breach of the entire Contract.

REPORTING PROVISIONS

Any failure to comply with the reporting provisions of the policies shall not affect coverage provided to the County, its officers, officials, employees or volunteers.

PRIMARY COVERAGE

The Contractor's insurance coverage shall be primary insurance as respects the County, its officers, officials, employees and volunteers. Any insurance or self-insurance maintained by the County, its officers, officials, employees or volunteers shall be in excess of the Contractor's insurance and shall not contribute with it.

PREMIUM PAYMENTS

The insurance companies shall have no recourse against the County of El Dorado its officers, agents, employees, or any of them for payment of any premiums or assessments under any policy issued by any insurance company.

CONTRACTOR'S OBLIGATIONS

Contractor's indemnity and other obligations shall not be limited by the insurance required herein and shall survive the expiration of this Contract.

8.2 BONDS

- 8.2.1 **General Requirements for Bonds:** Before commencing any Work under the Contract, the Contractor shall provide all bonds to the Owner. These bonds shall be in the amounts and for the purposes specified below. They shall be Surety bonds and shall be issued by corporations duly and legally licensed and qualified to transact business in the State of California. They shall be maintained by him and at his expense during the entire life of the Contract or later as provided.
- 8.2.2 **Performance Bond:** One bond shall be in the amount of 100 percent of the Awarded Contract and shall guarantee the faithful performance of the Contract and shall insure the Owner during the life of the Contract and the Guarantee period. The Contractor may provide, subject to approval by the Owner, a separate guarantee bond upon completion of and acceptance of the work.
- 8.2.3 **Payment Bond:** One bond shall be in the amount of 100 percent of the Awarded Contract and shall guarantee the payment in full of all claims for labor and materials in accordance with the provisions of the laws of the State of California.
- 8.2.4 **Change of Surety:** If, at any time a Surety on such bonds becomes irresponsible or loses its right to do business in the State of California, the Owner may require another Surety which the Contractor shall furnish within ten (10) calendar days after receipt of written notice to do so.

8.2.5 Authentication of Bonds: Evidence of authority of an attorney-in-fact acting for the corporate Surety must be provided in the form of a certificate as to his power of attorney and to the effect that it is not terminated and remains in full force and effect on the date of the bonds. The form of the bonds shall be in accordance with those provided in the Draft Agreement.

ARTICLE 9

UNCOVERING AND CORRECTION OF WORK

9.1 DEVIATION FROM CONTRACT DOCUMENTS

9.1.1 Improper Work: If the Contractor shall vary from the Contract Documents in the form or quality of the Work, or the amount or value of the materials herein provided for, the Owner shall have the right to order such improper work or materials removed, remade, or replaced. In the event that the Work is ordered changed, any other work disturbed or damaged by such alteration shall be made good at the Contractor's expense.

9.2 CORRECTION OF WORK

9.2.1 Covered or Completed Work: If any work is covered contrary to the written instructions of the Owner's Representative, or the Inspector, if one is appointed, it must, if requested, be uncovered for observation and replaced at the Contractor's expense.

9.2.2 Inspection of Covered Work: If the Owner's Representative or the Inspector, if one is appointed, considers it necessary or advisable that covered Work be inspected or tested by others, the Contractor, upon request, will uncover, expose, or otherwise make available for observation, inspection, or testing as the Inspector may require, that portion of the Work in question, furnishing all necessary labor, materials, tools, and equipment. If it is found that such Work is defective, the Contractor will bear all the expenses of such uncovering, exposure, observation, inspection, and testing and of satisfactory reconstruction; if, however, such Work is not found to be defective, the Contractor will be allowed an increase in the Contract price or an extension of the Contract time, or both, directly attributable to such uncovering, exposure, observation, inspection, testing, and construction, and an appropriate Change Order shall be issued.

9.2.3 Rejected Work: The Contractor shall promptly remove from the premises all Work rejected by Owner for failure to comply with the Contract Documents, whether incorporated in the construction or not, and the Contractor shall promptly replace and re-execute the work either during the term of the Contract or during the warranty period, in accordance with the Contract Documents and without expense to the Owner and shall bear the expense of making good all Work of other contractors destroyed or damaged by such removal or replacement.

9.2.4 Cost of Correction: All removal and replacement Work shall be done at the Contractor's expense. If the Contractor does not take action to remove such rejected Work within ten (10) days after receipt of written notice, the Owner may remove such Work and store the materials at the expense of the Contractor. Owner also may perform such Work or repairs itself and charge the expense to the Contractor.

ARTICLE 10

SUSPENSION OF CONTRACT

10.1 SUSPENSION OF WORK

10.1.1 Owner May Suspend: The Owner may suspend the Work or any portion thereof for a period of not more than ninety (90) days or such further time as agreed upon by the Contractor, by written notice to the Contractor and the Inspector which shall fix the date on which work shall be resumed.

10.1.2 Resumption of Work: The Contractor shall resume that Work on the dates so fixed. The Contractor shall be allowed an increase in the Contract price or an extension of the Contract time, or both, directly attributed to any suspension.

*** END OF CONDITIONS OF THE CONTRACT ***

APPLICATION AND CERTIFICATE FOR PAYMENT - EXHIBIT A

TO OWNER:
 El Dorado County
 3000 Fairlane, #2
 Placerville, CA 95667
 FROM CONTRACTOR:

PROJECT:

APPLICATION #: 1
 PERIOD TO:
 PROJECT NOS:
 CONTRACT DATE:

Distribution to:

<input type="checkbox"/>	County
<input type="checkbox"/>	Cont Adm
<input type="checkbox"/>	Contractor
<input type="checkbox"/>	
<input type="checkbox"/>	

CONTRACTOR'S APPLICATION FOR PAYMENT

Application is made for payment, as shown below, in connection with the Contract.
 Continuation Sheet is attached.

1. ORIGINAL CONTRACT SUM----- \$

2. Net change by Change Orders-----\$

3. CONTRACT SUM TO DATE (Line 1 +/- 2) \$

4. TOTAL COMPLETED & STORED TO DATE-\$
 (Column G on Continuation Sheet)

5. RETAINAGE:

a. _____ of Completed Work \$
 (Columns D+E on Continuation Sheet)

b. _____ of Stored Material \$
 (Column F on Continuation Sheet)

Total Retainage (Line 5a + 5b or
 Total in Column 1 of Continuation Sheet----- \$

6. TOTAL EARNED LESS RETAINAGE----- \$
 (Line 4 less Line 5 Total)

7. LESS PREVIOUS CERTIFICATES FOR PAYMENT
 (Line 6 from prior Certificate)----- \$

8. CURRENT PAYMENT DUE----- \$

9. BALANCE TO FINISH, INCLUDING RETAINAGE
 (Line 3 less Line 6) \$

The undersigned Contractor certifies that to the best of the Contractor's knowledge, information and belief the Work covered by this Application for Payment has been completed in accordance with the Contract Documents, that all amounts have been paid by the Contractor for Work for which previous Certificates for Payment were issued and payments received from the Owner, and that current payment shown therein is now due.

CONTRACTOR:

By: _____ Date: _____

State of: California
 County of: El Dorado

CERTIFICATE FOR PAYMENT

In accordance with Contract Documents, based on on-site observations and the data comprising application, the Contract Administrator certifies to El Dorado County that to the best of the Contract Administrator's knowledge, information and belief the Work has progressed as indicated, the quality of the Work is in accordance with the Contract Documents, and the Contractor is entitled to payment of the AMOUNT CERTIFIED.

AMOUNT CERTIFIED ----- \$
 (Attach explanation if amount certified differs from the amount applied for. Initial all figures on this application and on the Continuation Sheet that are changed to conform to the amount certified.)

CONTRACT ADMINISTRATOR

By: _____ Date: _____

This Certificate is not negotiable. The AMOUNT CERTIFIED is payable only to the Contractor named herein. Issuance, payment and acceptance of payment are without prejudice to any rights of the Owner or Contractor under this Contract.

CHANGE ORDER SUMMARY	ADDITIONS	DEDUCTIONS
Total changes approved in previous months by Contract Administrator		
Total approved this Month		
TOTALS		
NET CHANGES by Change Order		

**EXHIBIT B1.1
SCOPE MAP**

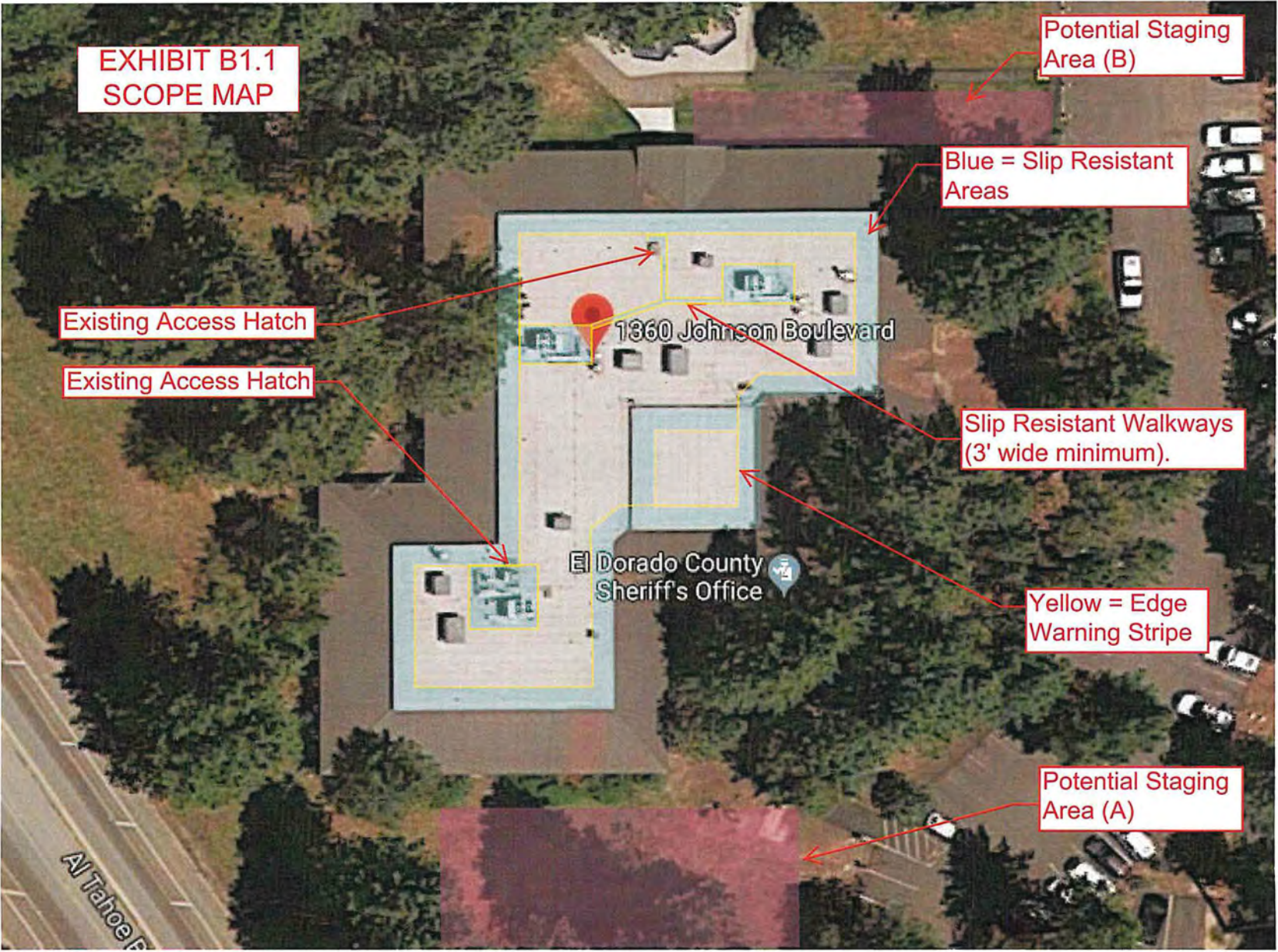

Potential Staging Area (B)

Blue = Slip Resistant Areas

Existing Access Hatch

Existing Access Hatch

1360 Johnson Boulevard

Slip Resistant Walkways (3' wide minimum).

El Dorado County Sheriff's Office

Yellow = Edge Warning Stripe

Potential Staging Area (A)

Al Tahoe Blvd

SECTION 070150.72 - REHABILITATION OF BUILT-UP ROOFING

PART 1 - GENERAL

1.1 SUMMARY

- A. This Section includes the following:
 - 1. Roof re-coating preparation.
 - 2. Application of reinforced fluid-applied roof membrane and flashings over existing built-up asphalt roofing.

1.2 DEFINITIONS

- A. Roofing Terminology: Refer to ASTM D 1079 and glossary in NRCA's "The NRCA Roofing Manual" for definition of terms related to roofing work in this Section.
- B. Roofing Re-Coating Preparation: Existing roofing that is to remain and be prepared to accept restorative coating application.
- C. Patching: Removal of a portion of existing membrane roofing system from deck or removal of selected components and accessories from existing membrane roofing system and replacement with similar materials.
- D. Remove: Detach items from existing construction and legally dispose of them off-site unless indicated to be removed and reinstalled.
- E. Existing to Remain: Existing items of construction that are not indicated to be removed.
- F. Construction Waste: Building and site improvement materials and other solid waste resulting from construction, remodeling, renovation, or repair operations. Construction waste includes packaging.
- G. Demolition Waste: Building and site improvement materials resulting from re-roofing preparation, demolition or selective demolition operations.
- H. Disposal: Removal off-site of demolition and construction waste and subsequent sale, recycling, reuse, or deposit in landfill or incinerator acceptable to authorities having jurisdiction.

1.3 ACTION SUBMITTALS

- A. Product Data: For each type of product specified.
- B. SDS: For each type of product specified.
- C. Sustainable Design Submittals:
 - 1. Indicate CRRC Compliance.

2. Indicate Food, Conservation, and Energy Act of 2008 Bio-based material requirement compliance.
 - a. Indicate type of bio-based material in product.
 - b. Indicate the percentage of bio-based content per unit of product.

1.4 INFORMATIONAL SUBMITTALS

- A. Qualification Data: For Installer, Manufacturer, and Roofing Inspector.
 1. Letter written for this Project indicating manufacturer approval of Installer to apply specified products and provide specified warranty.

1.5 CLOSEOUT SUBMITTALS

- A. Maintenance Data: To include in maintenance manuals.
- B. Warranties: Executed copies of approved warranty forms.

1.6 PROJECT CONDITIONS

- A. Weather Limitations: Proceed with rehabilitation work only when existing and forecasted weather conditions permit Work to proceed without water entering into existing roofing system or building.
 1. Store all materials prior to application at temperatures recommended by manufacturer.
 2. Apply coatings within range of ambient and substrate temperatures recommended by manufacturer.
 3. Do not apply roofing in snow, rain, fog, or mist.
- B. Protect building to be rehabilitated, adjacent buildings, walkways, site improvements, exterior plantings, and landscaping from damage or soiling from rehabilitation operations.
- C. Maintain access to existing walkways, corridors, and other adjacent occupied or used facilities.
- D. Daily Protection: Coordinate installation of roofing so insulation and other components of roofing system not permanently exposed are not subjected to precipitation or left uncovered at the end of the workday or when rain is forecast.

1.7 WARRANTY

- A. Manufacturer: Manufacturer's standard warranty form, covering work of this Section [and extended system components indicated], in which manufacturer agrees to repair or replace components of roofing system that fail in materials or workmanship within warranty period.
 1. Warranty Period: 20 years from date of completion.

- B. Installer Warranty: Installer's warranty signed by Installer, covering the Work of this Section.
 - 1. Warranty Period: 2 years from date of completion.
- C. Manufacturer Inspection Services: By manufacturer's technical representative, to report maintenance responsibilities to Owner necessary for preservation of Owner's warranty rights. The cost of manufacturer's inspections is included in the Contract Sum.
 - 1. Inspections to occur in following years: 2, 5, 10, 15 following completion.

PART 2 - PRODUCTS

2.1 MANUFACTURERS

- A. Basis-of-Design Manufacturer/Product: The roof system specified in this Section is based upon products of Tremco, Inc., Beachwood, OH, (800) 562-2728, www.tremcoroofing.com that are named in other Part 2 articles. Provide specified products.
- B. Source Materials: Obtain roofing materials from single source from single manufacturer.

2.2 PERFORMANCE REQUIREMENTS

- A. General Performance: Rehabilitated roofing shall withstand exposure to weather without failure or leaks due to defective manufacture or installation.
 - 1. Accelerated Weathering: Roofing system shall withstand 2000 hours of exposure when tested according to ASTM G 152, ASTM G 154, or ASTM G 155.
- B. Material Compatibility: Provide roofing materials that are compatible with one another under conditions of service and application required, as demonstrated by roofing manufacturer based on testing and field experience.
- C. Exterior Fire-Test Exposure: Roofing system exterior fire-test exposure performance following application of rehabilitation coating shall be not be less than that of the pre-rehabilitated roof performance when tested in accordance with ASTM E 108, based upon manufacturer's tests of identical applications.
- D. Energy Performance: Provide rehabilitated roofing with an initial Solar Reflectance Index of not less than 78 when calculated according to ASTM E 1980, based on testing identical products by a qualified testing agency.
- E. Bio-Based Content: Provide roofing rehabilitation coating materials meeting requirements of USDA Bio-based Affirmative Procurement Program, with not less than 20 percent bio-based content.

2.3 MATERIALS

- A. General: Rehabilitative re-coating materials recommended by roofing system coating manufacturer for intended use and compatible with components of existing membrane roofing system.

2.4 FLUID-APPLIED ROOFING MEMBRANE

- A. Polyurethane Elastomeric Fluid-Applied System: Two-coat fluid-applied roofing membrane formulated for application over prepared existing roofing substrate.
1. Polyurethane roof coating system base coat, bio-based, low-odor low-VOC two-part, for use with a compatible top coat.
 - a. Basis of design product: Tremco, AlphaGuard BIO Base Coat.
 - b. Combustion Characteristics, UL 790: Class A, for two-coat system.
 - c. Volatile Organic Compounds (VOC), maximum, ASTM D3960: 1 g/L.
 - d. Accelerated Weathering, 5000 hours, ASTM G154: Pass.
 - e. Hardness, Shore A, minimum, ASTM D2240: 88.
 - f. Solids, by volume, ASTM D2697: 100 percent.
 - g. Bio-Based Content, Minimum: 70 percent.
 - h. Minimum Thickness, Base Coat non-reinforced over Granular Surfaced MB: 48 mils (1.22 mm) wet.
 2. Polyurethane roof coating system top coat, bio-based low-odor low-VOC two-part, for application over compatible base coat.
 - a. Basis of design product: Tremco, AlphaGuard BIO Top Coat.
 - b. Combustion Characteristics, UL790: Class A, for two-coat system.
 - c. Volatile Organic Compounds (VOC), maximum, ASTM D3960: <6 g/L.
 - d. Solar Reflectance Index (SRI), ASTM E1980: For white, not less than 103.
 - e. Accelerated Weathering, 5000 hours, ASTM G 154: Pass.
 - f. Hardness, Shore A, minimum, ASTM D2240: 81.
 - g. Solids, by volume, ASTM D2697: 100 percent.
 - h. Bio-Based Content, Minimum: 60 percent.
 - i. Minimum Thickness, partially reinforced system: 32 mils (0.81 mm) wet.
 - j. Minimum Thickness, Slip-Resistant Coat: 24 mils (0.60 mm) wet.
 - k. Color: White.

3. Primer for Non-Porous Surfaces: Single-part, water-based primer to promote adhesion of urethanes to metals, PVC and other non-porous surfaces.
 - a. Basis of design product: Tremco, AlphaGuard M-Prime.
 - b. Volatile Organic Compounds (VOC), maximum, ASTM D3960: 22 g/L.
 - c. Nonvolatile Content, minimum, ASTM D2369: 5 percent.
 - d. Density at 77 deg F (25 deg C): 8.3 lb/gal (1kg/L).

2.5 AUXILIARY MATERIALS

- A. General: Auxiliary materials recommended by roofing system manufacturer for intended use and compatible with existing roofing system and fluid-applied roofing system.
- B. Seam Sealer Mastic: Waterproof seam and patching material compatible with applied coating.
 1. Elastomeric Seam Sealer: White, single-component high solids moisture curing aliphatic polyurethane sealant, low-VOC, formulated for compatibility and use with specified roofing substrates.
 - a. Basis of design product: Tremco, SOLARGARD Seam Sealer.
 - b. Volatile Organic Compounds (VOC), maximum, ASTM D3960: 75 g/L.
 - c. Tensile Strength, ASTM D412: 270 psi (1861 kPa).
 - d. Tear Strength, ASTM D412: 35 pli.
 - e. Elongation, ASTM D412: 700 percent.
- C. Reinforcing Fabric:
 1. Permafab by Tremco, 4" width.
- D. Joint Sealant: Elastomeric joint sealant compatible with applied coating, with movement capability appropriate for application.
 1. Joint Sealant, Polyurethane: ASTM C920, Type S, Grade NS, Class 50 single-component moisture curing sealant, formulated for compatibility and use in dynamic and static joints; paintable.
 - a. Basis of design product: Tremco, TremSEAL Pro.
 - b. Volatile Organic Compounds (VOC), maximum, ASTM D3960: 40 g/L.
 - c. Hardness, Shore A, ASTM C661: 40.
 - d. Adhesion to Concrete, ASTM C794: 35 pli.

- e. Tensile Strength, ASTM D412: 350 psi (2413 kPa).
 - f. Color: White.
- E. Miscellaneous Accessories: Provide miscellaneous accessories recommended by roofing system manufacturer.
- 2.6 WALKWAYS & ROOF PERIMETER
- A. Walkway Product: Compatible slip-resistant fluid-applied walkway product.
- 1. Polyurethane Bio-Based Top Coat, Slip-Resistant: Second top coat with broadcast slip-resistant aggregate.
 - a. Basis of design product: Tremco, AlphaGuard BIO Top Coat Slip Resistant.
 - b. Minimum Thickness, Non-Skid Coat: 1.5 gals/SQ (24 wet mils); (0.60 mm) wet.
 - c. #11 Sieve Roofing Granules: 20 to 30 lb/100 sq. ft..
 - d. Color: White.
 - e. Outline: Yellow
 - f. Volatile Organic Content (VOC) ASTM D3960: <6 g/l .

PART 3 - EXECUTION

3.1 EXAMINATION

- A. Examine existing roofing substrates, with Installer present, for compliance with requirements and for other conditions affecting application and performance of roof coatings.
- 1. For the record, prepare written report, endorsed by Installer, listing conditions detrimental to performance.
 - 2. Verify compatibility of approved re-coating system with and suitability of substrates.
 - 3. Verify that substrates are visibly dry and free of moisture.
 - 4. Verify that roofing membrane surfaces have adequately aged to enable proper bond with re-coating system base coat.
 - 5. Verify that existing roofing membrane is free of blisters, splits, open laps, indications of shrinkage, and puncture damage or other indications of impending roof system failure.
 - 6. Commencing application of fluid-applied re-coating membrane indicates acceptance of surfaces and conditions.

3.2 PREPARATION

- A. Protect existing roofing system that is indicated not to be rehabilitated, and adjacent portions of building and building equipment.
 - 1. Mask surfaces to be protected. Seal joints subject to infiltration by coating materials.
 - 2. Limit traffic and material storage to areas of existing roofing membrane that have been protected.
 - 3. Maintain temporary protection and leave in place until replacement roofing has been completed.

3.3 ROOFING COATING PREPARATION

- A. Membrane Surface Preparation:
 - 1. Remove loose granular aggregate from granular aggregate-surfaced built-up bituminous roofing.
 - 2. Remove walkway pads, and accessories from roofing membrane.
 - 3. Remove blisters, ridges, buckles, and other substrate irregularities from existing roofing membrane that would inhibit application of uniform, waterproof coating.
 - 4. Substrate Cleaning: Clean substrate of contaminants such as dirt, debris, oil, and grease that can affect adhesion of coating by power washing at maximum 2,000 psi.
 - a. Dispose of waste water in accordance with requirements of authorities having jurisdiction.
 - 5. Verify that existing substrate is dry before proceeding with application of coating. Spot check substrates with an electrical capacitance moisture-detection meter.
- B. Existing Flashing and Detail Preparation: Repair flashings, gravel stops, copings, and other roof-related sheet metal and trim elements. Reseal joints, replace loose or missing fasteners, and replace components where required to leave in a watertight condition.
 - 1. Do not damage metal counterflashings that are to remain. Replace metal counterflashings damaged during removal with counterflashings of same metal, weight or thickness, and finish.
 - 2. Remove penetration flashings and coat directly to the penetrations with a reinforced Base Coat.
- C. Surface Priming: Prime metal surfaces to receive fluid-applied coating using coating manufacturer's recommended product for substrate material. Apply at application rate recommended by manufacturer.
 - 1. Ensure primer does not puddle and substrate has complete coverage.

2. Allow to cure completely prior to application of coating.

D. Membrane Repair: Repair membrane at locations with irregularities using seam sealer mastic and reinforcing fabric.

E. Membrane Seam Reinforcement: Reinforce membrane seams using AlphaGuard Bio Base Coat and reinforcing fabric of width specified in Part 2. Center embedded reinforcing fabric on seam.

1. Use 6" wide fabric at the edge metal areas.

3.4 FLUID-APPLIED FLASHING APPLICATION

A. Fluid-Applied Flashing and Detail Base Coat Application: Complete base coat and full-fabric reinforcement at parapets, curbs, penetrations, and drains prior to application of field of fluid-applied membrane. Apply base coat in accordance with manufacturer's written instructions.

1. Apply base coat on prepared and primed surfaces and spread coating evenly. Extend coating all of the way up vertical surfaces and 4 inches onto horizontal surfaces.

2. Base Coat coverage rate on vertical surfaces is 64 wet mils.

3. Full reinforcement is required on vertical surfaces with either Permafab or AlphaGuard Glass.

4. Back roll to achieve minimum coating thickness as follows, unless additional thickness is recommended by manufacturer; verify thickness of base coat as work progresses.

5. Fabric Reinforcement: Embed fabric reinforcement into wet base coat. Lap adjacent flashing pieces of fabric minimum 3 inches along edges and 6 inches at end laps.

a. Roll surface of fabric reinforcing to completely embed and saturate fabric. Leave finished base coat with fabric free of pin holes, voids, or openings.

6. Integrate the metal base of the vents into the base flashings.

a. Bridge the base flashings-to-metal vents as needed with materials acceptable to the roofing manufacturer.

3.5 FLUID-APPLIED MEMBRANE APPLICATION

A. Fluid-Applied Membrane Base Coat Application: Apply base coat to field of membrane in accordance with manufacturer's written instructions.

1. Apply base coat on prepared and primed surfaces and spread coating evenly.

2. Back roll to achieve minimum coating thickness as follows, unless greater thickness is recommended by manufacturer; verify thickness of base coat as work progresses.

B. Top Coat Application: Apply top coat to field of membrane and flashings uniformly in a complete, continuous installation.

1. Following curing of base coat and prior to application of top coat, sand raised or exposed edges of fabric reinforcement.
 2. Allow base coat to cure prior to application of top coat.
 3. Prime base coat prior to application of top coat if top coat is not applied within 72 hours of the base coat application, using manufacturer's recommended primer.
 4. Apply top coat extending coating up vertical surfaces and out onto horizontal surfaces. Install top coat over field base coat and spread coating evenly.
 5. Apply top coat and back roll to achieve not less than minimum coating thickness indicated in Part 2 product listing, unless greater thickness is recommended by manufacturer. Verify application thickness as work progresses.
 6. Avoid foot traffic on new fluid-applied membrane for a minimum of 24 hours.
- C. Joint Sealant: Apply joint sealant at terminations of coating application and in locations required for complete weathertight application.
- D. Slip-Resistant Top Coat: Apply walkway and roof perimeter second top coat following application and curing of top coat. Locate walkways as indicated on the roof plan. Roof perimeter slip-resistant area will consist of the entire roof perimeter, 10' back from the edge of the roof.
1. Mask slip-resistant locations with tape.
 2. Prime first top coat prior to application of walkway top coat if walkway top coat is not applied within 72 hours of the first top coat application, using manufacturer's recommended primer.
 3. Apply walkway top coat and back roll to achieve not less than minimum coating thickness indicated in Part 2 product listing, unless greater thickness is recommended by manufacturer. Verify application thickness as work progresses.
 4. Broadcast Slip-Resistant Top Coat Aggregate in wet top coat at rate indicated in Part 2 product listing or as otherwise recommended by coating manufacturer.
 - a. Back roll granules and top coat creating even dispersal of sand. Remove masking immediately.
 - b. Apply a 4" wide, yellow AlphaGuard Bio Top Coat stripe at the edges of the walkway, and 10' back from the edge of the roof perimeter (at the beginning of the slip-resistant perimeter).

3.6 FIELD QUALITY CONTROL

- A. Roofing Inspector: Owner will engage a qualified roofing inspector to perform roof tests and inspections and to prepare test reports.

- B. Roof Inspection: Engage roofing system manufacturer's technical personnel to inspect roofing installation, and submit reports to the Owner. Inspect work as follows:
 - 1. Upon completion of preparation of roof coating substrate, prior to application of coating materials.
 - 2. Following application of coating to flashings and application of base coat to field of roof.
 - 3. Upon completion of coating but prior to re-installation of other roofing components.
- C. Repair fluid-applied membrane where inspections indicate that they do not comply with specified requirements.
- D. Arrange for additional inspections, at Contractor's expense, to verify compliance of replaced or additional work with specified requirements.

3.7 DISPOSAL

- A. Collect demolished materials and place in containers. Promptly dispose of demolished materials. Do not allow demolished materials to accumulate on-site.
- B. Transport and legally dispose of demolished materials off Owner's property.

3.8 PROTECTING AND CLEANING

- A. Protect roofing system from damage and wear during remainder of construction period.
- B. Correct deficiencies in or remove coating that does not comply with requirements, repair substrates, and reapply coating.
- C. Clean overspray and spillage from adjacent construction using cleaning agents and procedures recommended by manufacturer of affected construction.

END OF SECTION 070150.72



CAYWOOD NOPP WARD
 ARCHITECTS AND PLANNERS AIA
 1435 Alhambra Boulevard
 Alhambra, CA 91816
 916-222-7811

EL DORADO COUNTY GOVERNMENT CENTER
 SOUTH LAKE TAHOE BRANCH
 ALTAKE BLVD & JOHNSON BLVD, SOUTH LAKE TAHOE, CALIFORNIA

DATE: 11/11/11
 DRAWN BY: [Signature]
 CHECKED BY: [Signature]
 PROJECT NO: 11-0001

EXTERIOR ELEVATIONS

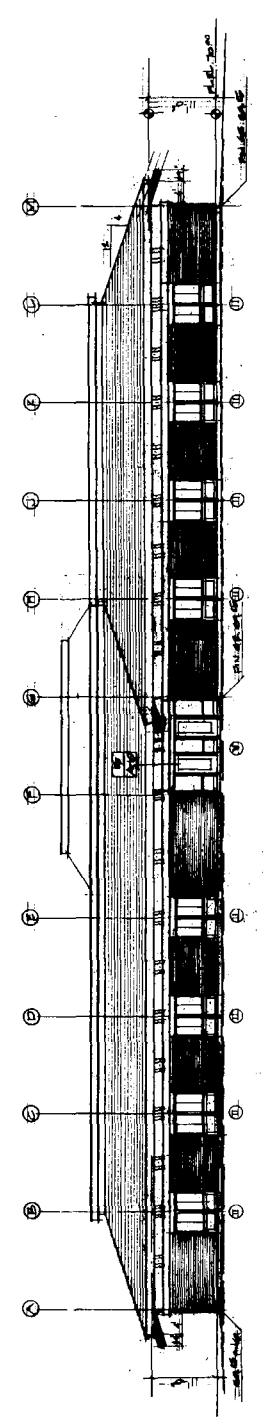

WEST EXTERIOR ELEVATION - 1/8" = 1'-0"

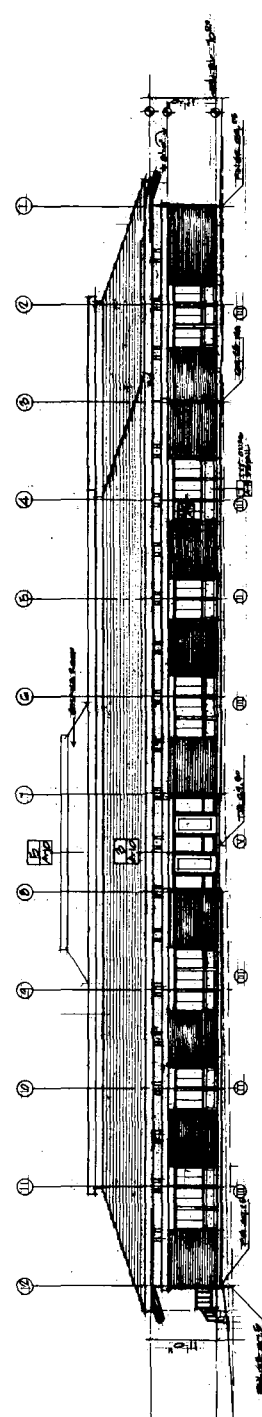

NORTH EXTERIOR ELEVATION - 1/8" = 1'-0"

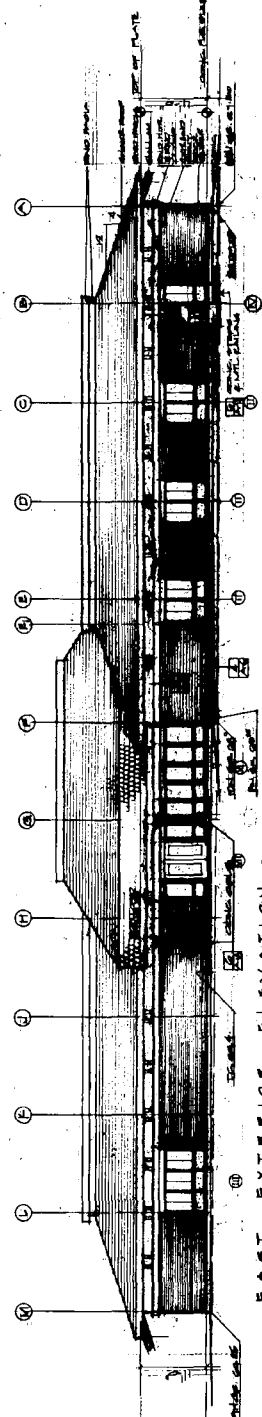

EAST EXTERIOR ELEVATION - 1/8" = 1'-0"

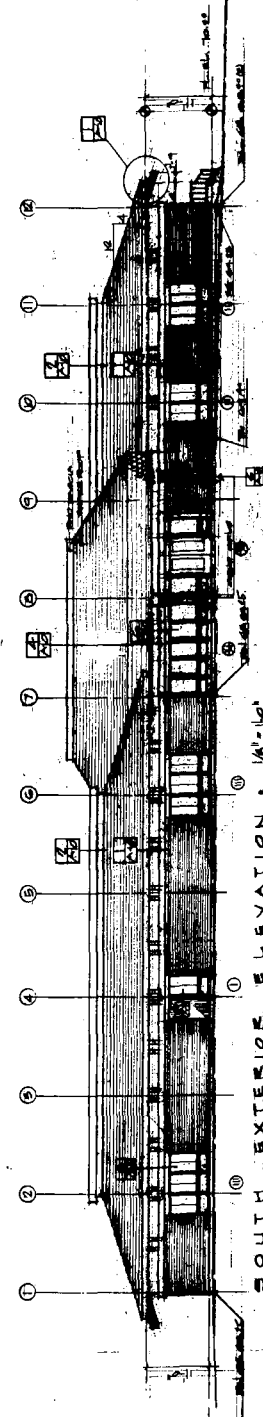

SOUTH EXTERIOR ELEVATION - 1/8" = 1'-0"



CAYWOOD NOPP WARD
 ARCHITECTS AND PLANNERS AIA
 1425 AVENUE B
 RICHMOND, CA 94804
 916.832.7511

EL DORADO COUNTY GOVERNMENT CENTER
 SOUTH LAKE TAHOE BRANCH
 14 TAHOE BLVD & JOHNSON BLVD, SOUTH LAKE TAHOE, CALIFORNIA

DATE: 11-15-04
 DRAWN BY: [Signature]
 CHECKED BY: [Signature]
 PROJECT: [Signature]

ROOF PLAN
 DETAILS

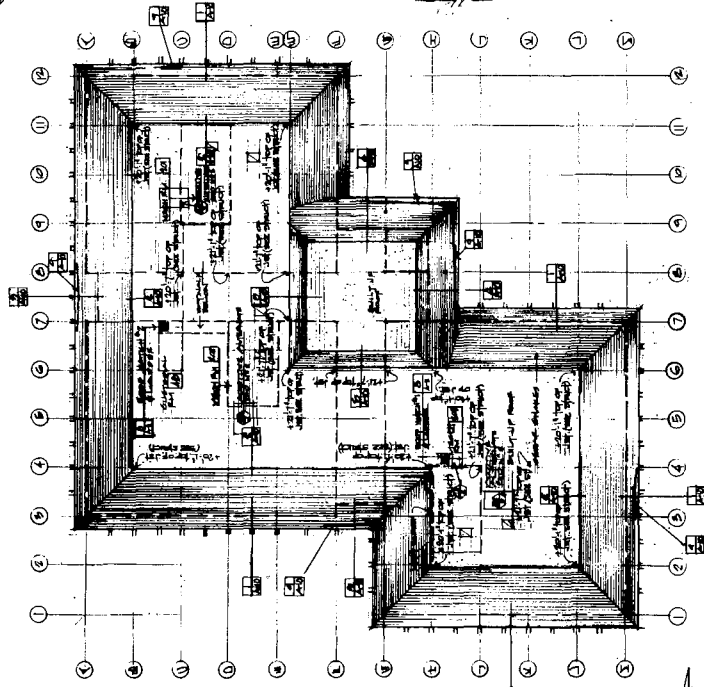
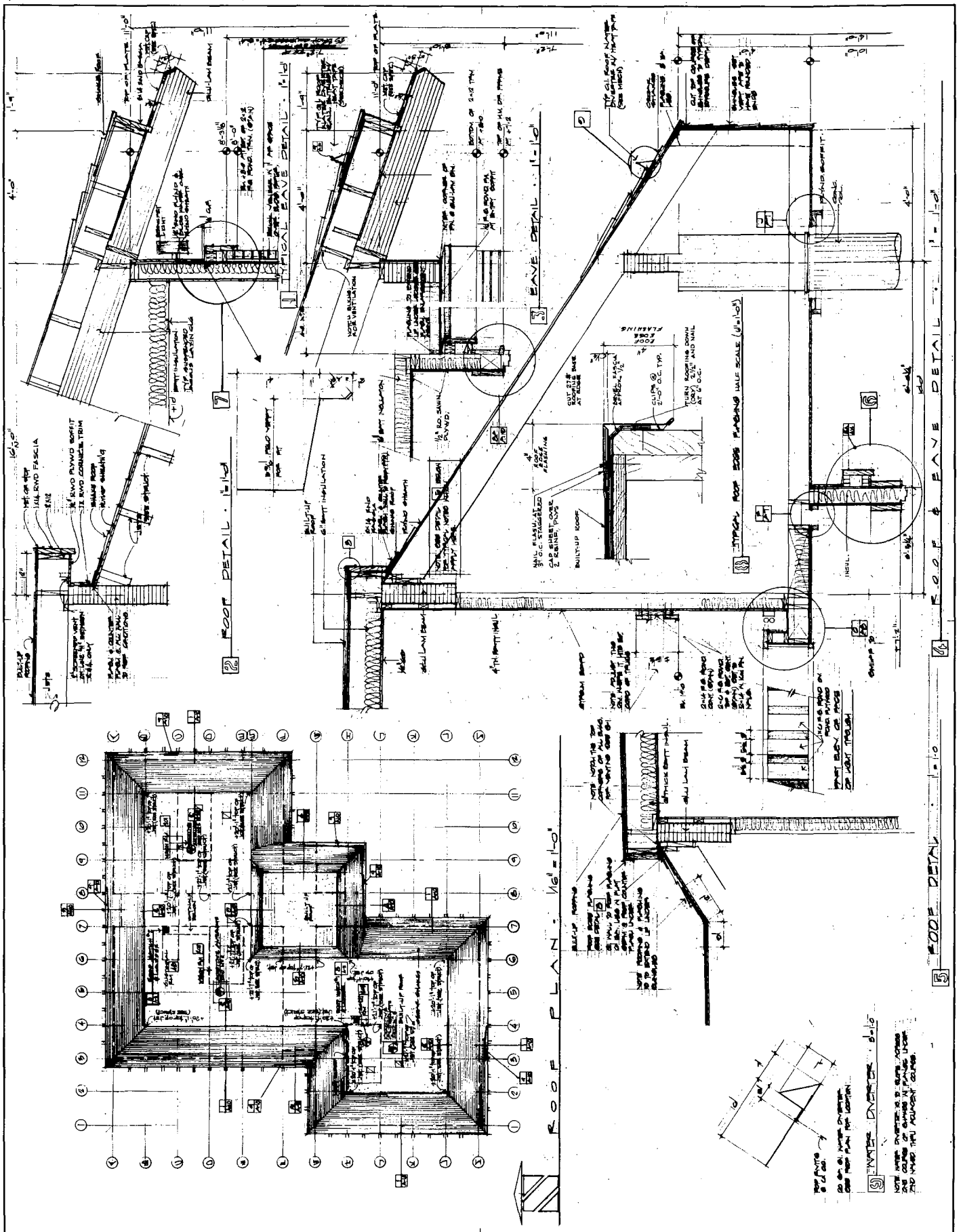

ROOF PLAN: 1/8" = 1'-0"

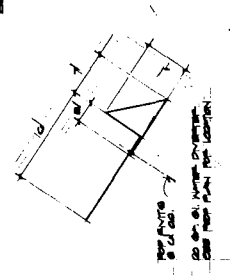

TRUSS OVERLAP: 6'-0"
 NOTE: TRUSS OVERLAP IS TO BE MAINTAINED THROUGHOUT THE ENTIRE LENGTH OF THE TRUSS AND SHALL BE MAINTAINED THROUGHOUT.

1 ROOF DETAIL: 1/2" = 1'-0"

2 ROOF DETAIL: 1/2" = 1'-0"

3 EAVE DETAIL: 1/2" = 1'-0"

4 TYPICAL ROOF EAVE FLASHING SCALE (1/2" = 1'-0")

5 ROOF DETAIL: 1/2" = 1'-0"

6 ROOF & EAVE DETAIL: 1/2" = 1'-0"



CAYWOOD NOPP WARD
 ARCHITECTS AND PLANNERS AIA
 1425 Alhambra Boulevard
 Pasadena, CA 91106
 626-792-7511

EL DONADO COUNTY GOVERNMENT CENTER
 SOUTH LAKE TAHOE BRANCH
 M. TAHOE BLVD & JOHNSON BLVD, SOUTH LAKE TAHOE, CALIFORNIA

DATE: 11/11/11
 DRAWN BY: [Signature]
 CHECKED BY: [Signature]

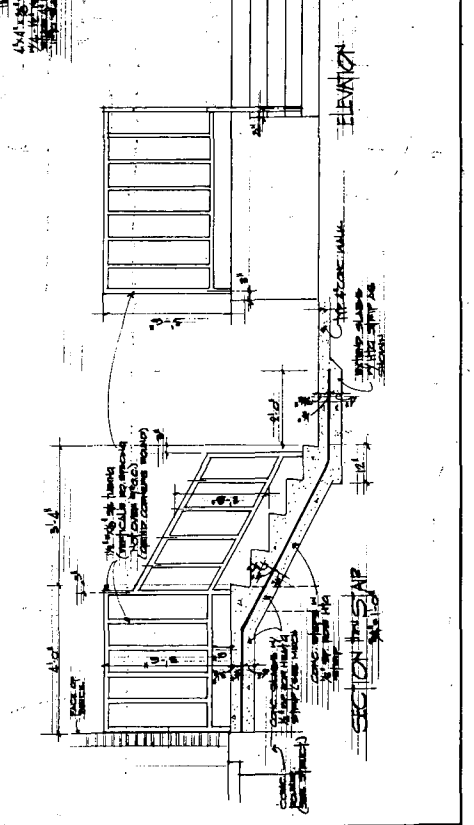
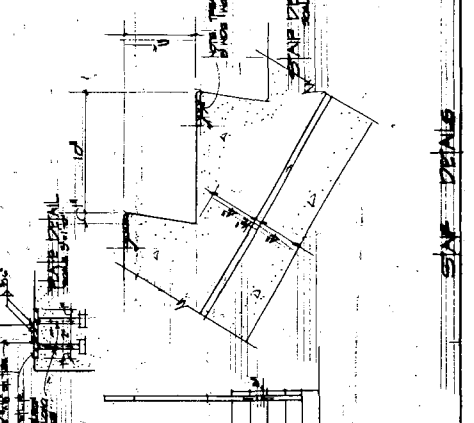
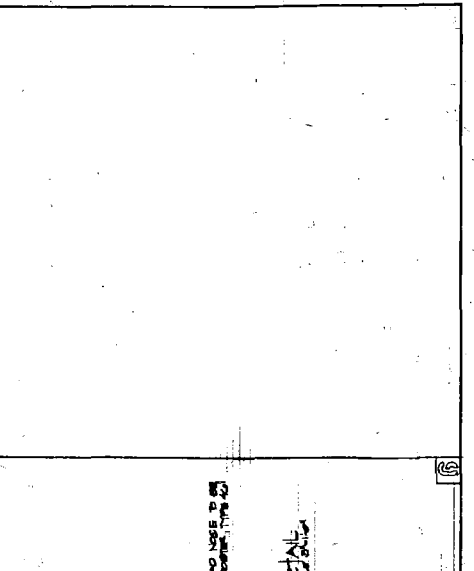
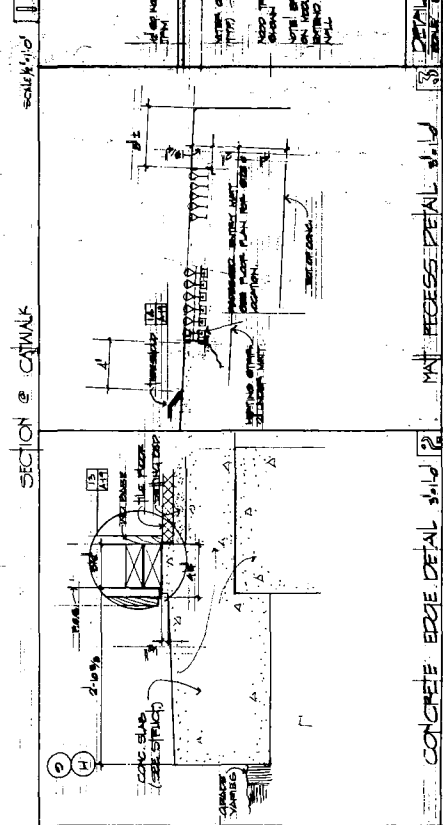
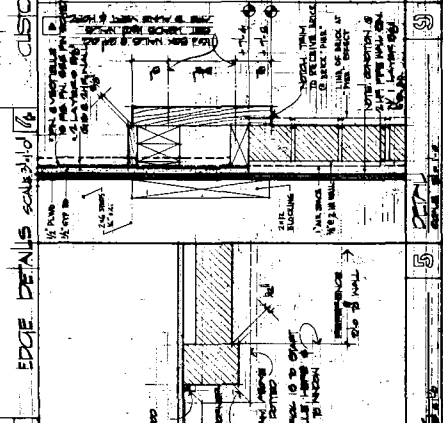
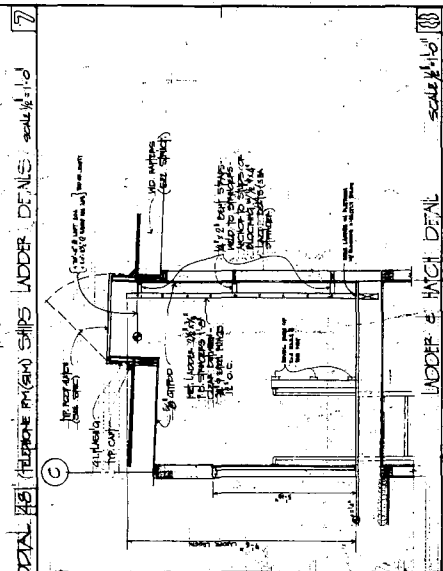
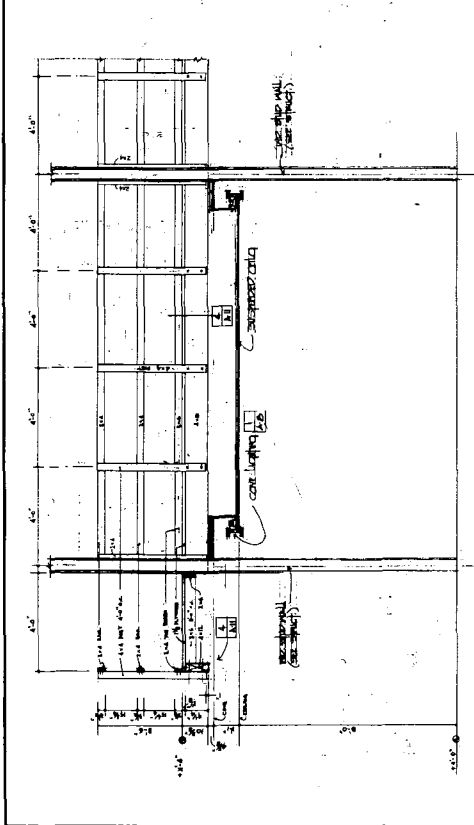
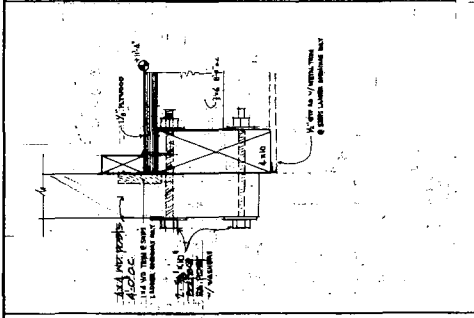
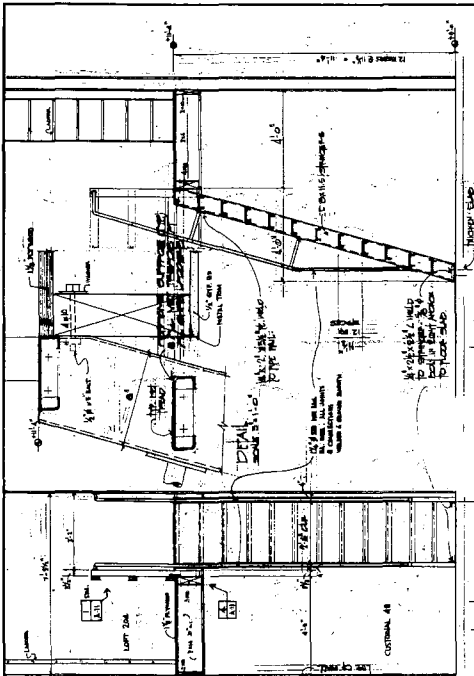
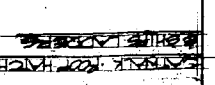

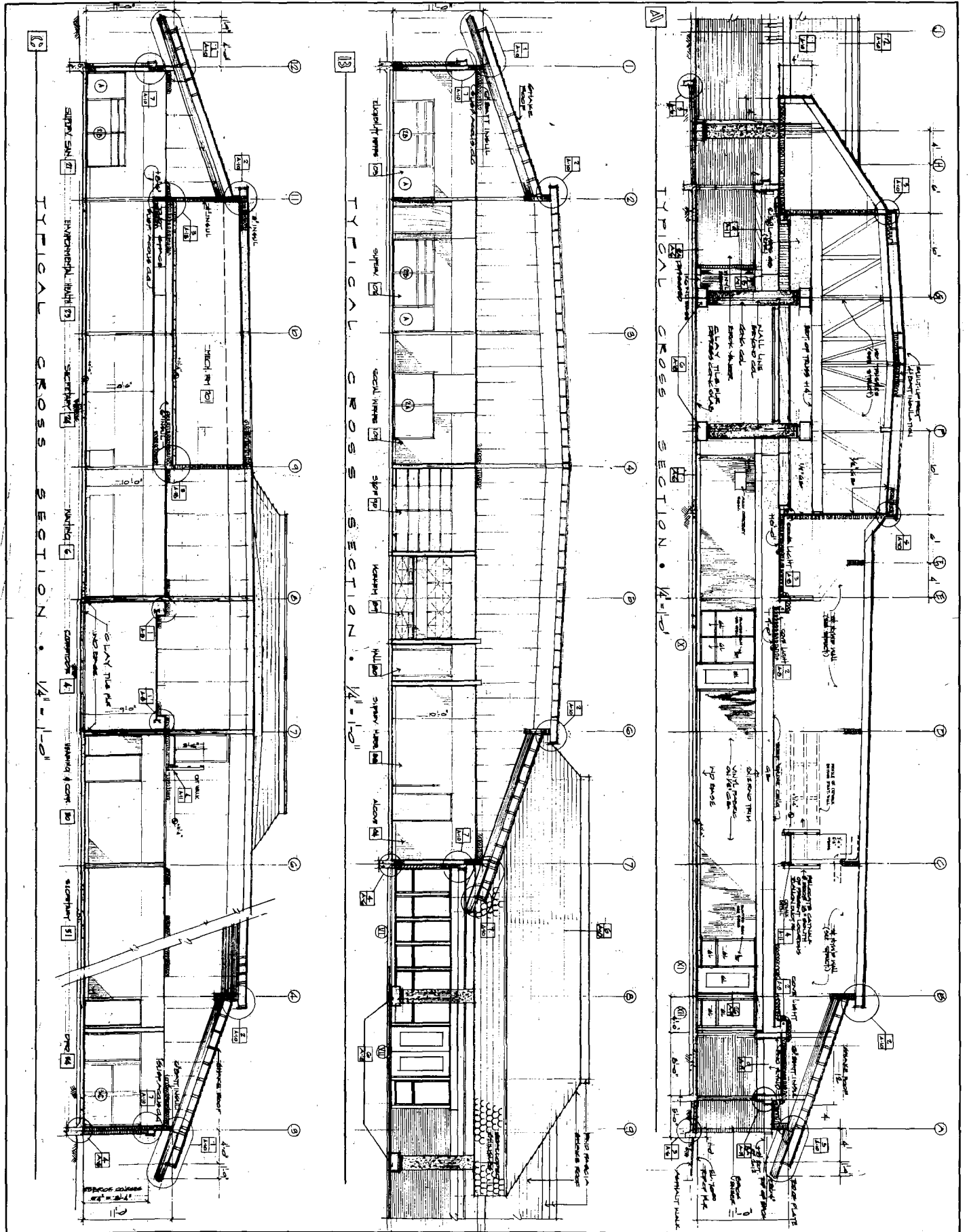

DATE: 07/18/11
 SHEET: 01

BUILDING SECTIONS

PROJECT: EL DORADO COUNTY GOVERNMENT CENTER
 SOUTH LAKE TAHOE BRANCH
 LOCATION: AL TAHOE BLVD & JOHNSON BLVD, SOUTH LAKE TAHOE, CALIFORNIA
 ARCHITECT: CAYWOOD NOPP WARD
 DATE: 07/18/11
 SHEET: 01

EL DORADO COUNTY GOVERNMENT CENTER
 SOUTH LAKE TAHOE BRANCH
 AL TAHOE BLVD & JOHNSON BLVD, SOUTH LAKE TAHOE, CALIFORNIA

CAYWOOD NOPP WARD
 ARCHITECTS AND PLANNERS AIA
 1435 Alhambra Boulevard, 310 Main Street
 Sacramento, Ca 95818 Picoville, Ca 95667
 916-452-7421 916-622-7611





CAYWOOD NOPP WARD
ARCHITECTS AND PLANNERS AIA
210 Main Street
Pomerville, CA 95007
916-222-7811

ROBERT I. CRAWFORD
CONSULTING ENGINEER
1525 ALAMOGORBO AVENUE
SAN MARINO, CALIF. 91761
916-425-7421

EL DORADO COUNTY GOVERNMENT CENTER
SOUTH LAKE TAHOE BRANCH
AL TAHOE BLVD & JOHNSON BLVD, SOUTH LAKE TAHOE, CALIFORNIA

NO. 1001
DATE 11/18/04
DRAWN BY [Signature]
CHECKED BY [Signature]
SCALE 3/4" = 1'-0"

SECTIONS & DETAILS

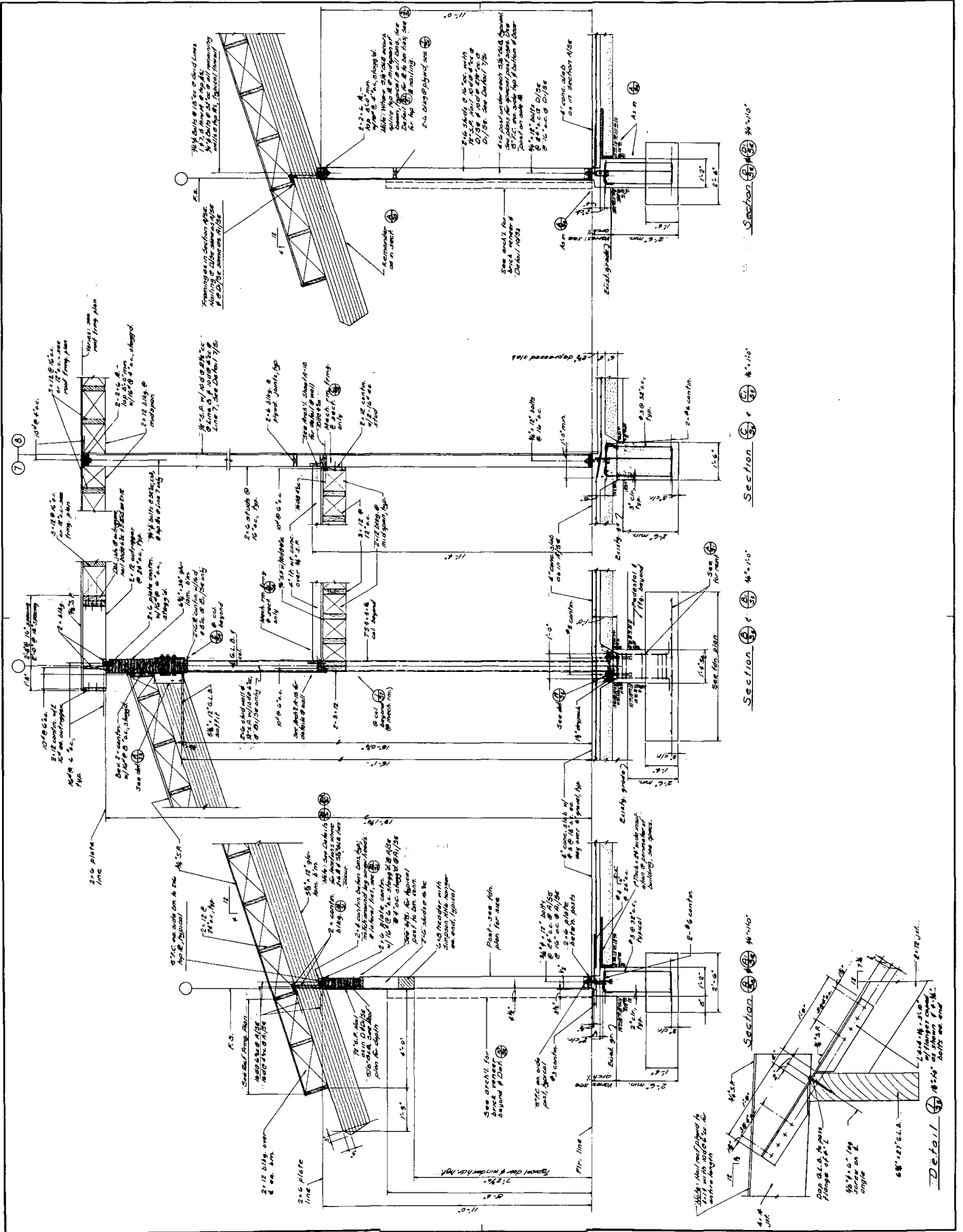



CAYWOOD NOPP WARD
 ARCHITECTS AND PLANNERS AIA
 210 MAIN STREET
 PLEASANTON, CA 95667
 916-222-7811

ROBERT J. CRAWFORD
 CONSULTING ENGINEER
 1435 KATHLEEN BOULEVARD
 SACRAMENTO, CA 95816
 916-422-7421

EL DORADO COUNTY GOVERNMENT CENTER
 SOUTH LAKE TAHOE BRANCH
 SOUTH LAKE TAHOE, CALIFORNIA
 14 TAHOE BLVD. & JOHNSON BLVD., SOUTH LAKE TAHOE, CALIFORNIA

DATE: 11/15/11
 DRAWN: J. WARD
 CHECKED: J. WARD
 SCALE: AS SHOWN

SECTIONS & DETAILS

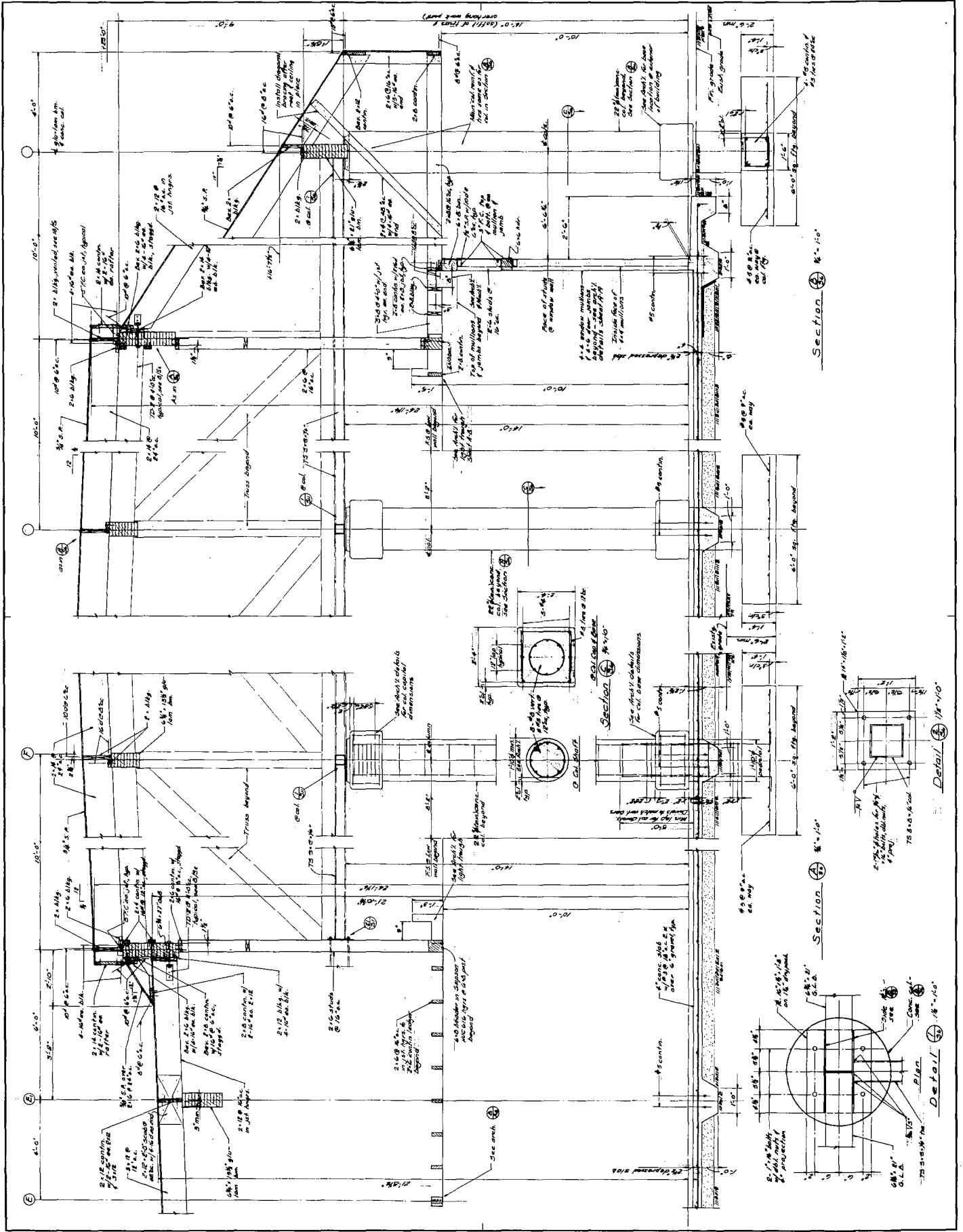

Section 1 1/4" = 1'-0"

Section 2 1/4" = 1'-0"

Detail 1 1/8" = 1'-0"

Detail 2 1/8" = 1'-0"



CAYWOOD NOPP WARD
 ARCHITECTS AND PLANNERS AIA
 1425 AVENUE OF THE STARS
 SUITE 200
 FARMINGTON, CT 06030
 (860) 646-7473

ROBERT J. CRAWFORD
 CLADDING ENGINEER
 1111 KINGSLEY
 SUITE 100
 SOUTH LAKE TAHOE, CALIFORNIA 96150
 (530) 423-2323

EL DORADO COUNTY GOVERNMENT CENTER
 SOUTH LAKE TAHOE BRANCH
 AL TAHOE BLVD & JOHNSON BLVD, SOUTH LAKE TAHOE, CALIFORNIA

SECTIONS & DETAILS

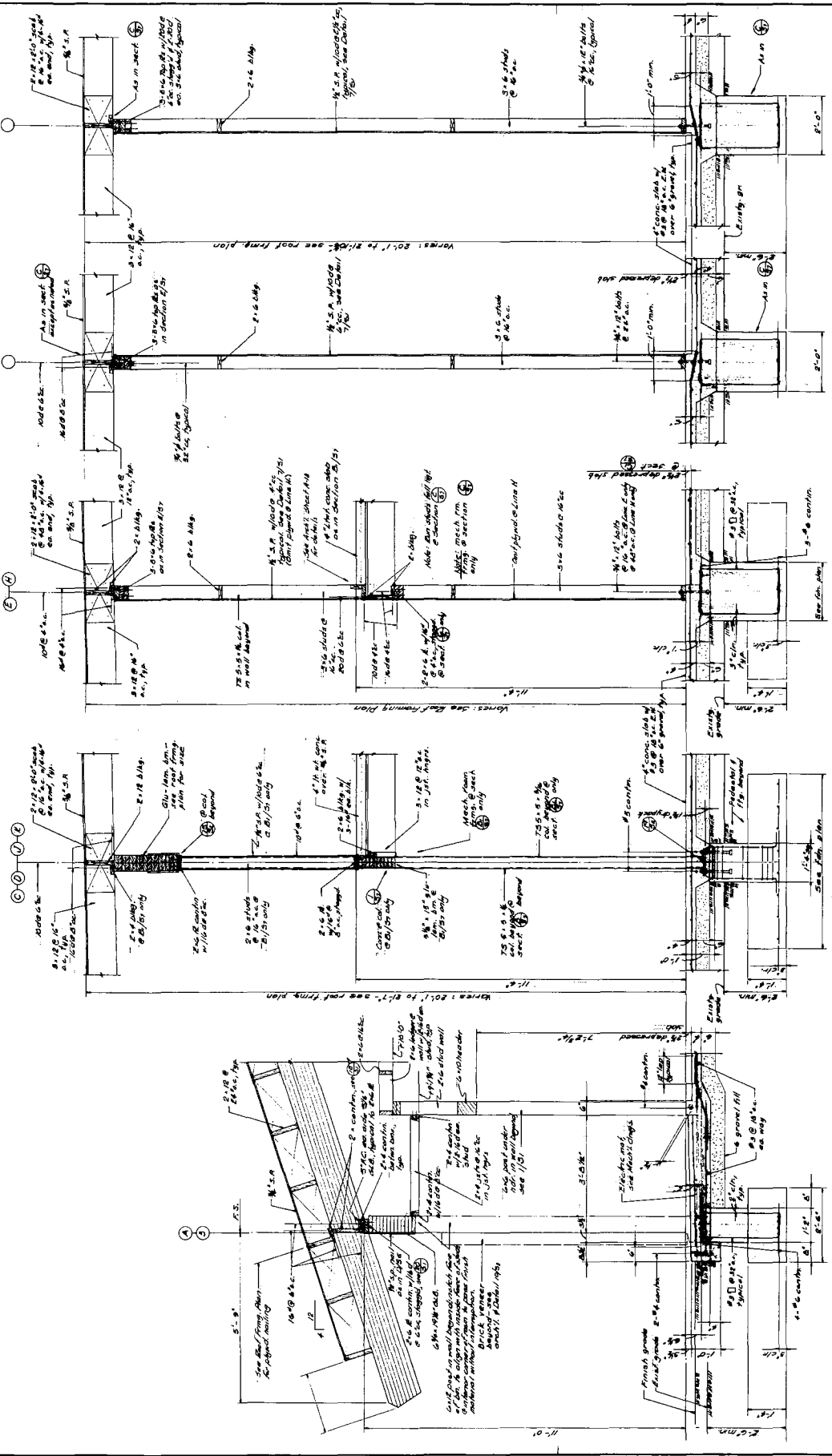

Section 1

Section 2

Section 3

Section 4

Section 5

Section 6

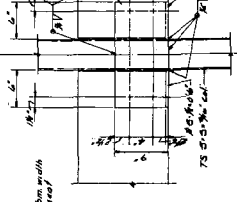
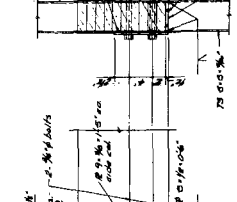
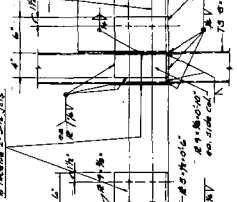
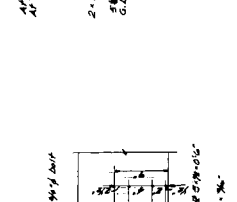
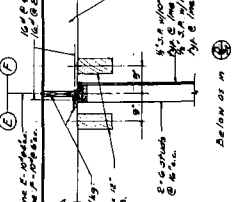
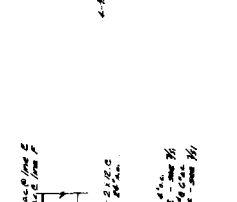
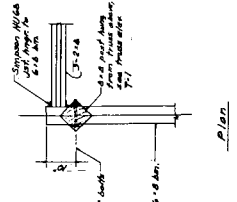
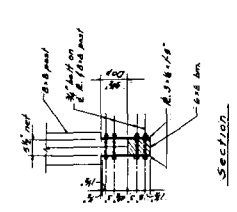

Detail 1

Detail 2

Detail 3

Detail 4

Detail 5

Detail 6

Detail 7

Detail 8



CAYWOOD NOPP WARD
 ARCHITECTS AND PLANNERS AIA
 145 KIMBERLY BOULEVARD
 FORTY-FIVE
 SACRAMENTO, CA 95818
 916-425-7271

ROBERT J. CRAWFORD
 CONSULTING ENGINEER
 1515 17TH AVENUE
 SACRAMENTO, CA 95811
 916-441-1515

EL DORADO COUNTY GOVERNMENT CENTER
 SOUTH LAKE TAHOE BRANCH
 ALTADE BLVD & JOHNSON BLVD, SOUTH LAKE TAHOE, CALIFORNIA

NO.	DATE
1	10/20/13
2	11/13/13
3	12/10/13
4	1/15/14
5	2/10/14
6	3/10/14
7	4/10/14
8	5/10/14
9	6/10/14
10	7/10/14
11	8/10/14
12	9/10/14
13	10/10/14
14	11/10/14
15	12/10/14
16	1/10/15
17	2/10/15
18	3/10/15
19	4/10/15
20	5/10/15
21	6/10/15
22	7/10/15
23	8/10/15
24	9/10/15
25	10/10/15
26	11/10/15
27	12/10/15
28	1/10/16
29	2/10/16
30	3/10/16
31	4/10/16
32	5/10/16
33	6/10/16
34	7/10/16
35	8/10/16
36	9/10/16
37	10/10/16
38	11/10/16
39	12/10/16
40	1/10/17
41	2/10/17
42	3/10/17
43	4/10/17
44	5/10/17
45	6/10/17
46	7/10/17
47	8/10/17
48	9/10/17
49	10/10/17
50	11/10/17
51	12/10/17
52	1/10/18
53	2/10/18
54	3/10/18
55	4/10/18
56	5/10/18
57	6/10/18
58	7/10/18
59	8/10/18
60	9/10/18
61	10/10/18
62	11/10/18
63	12/10/18
64	1/10/19
65	2/10/19
66	3/10/19
67	4/10/19
68	5/10/19
69	6/10/19
70	7/10/19
71	8/10/19
72	9/10/19
73	10/10/19
74	11/10/19
75	12/10/19
76	1/10/20
77	2/10/20
78	3/10/20
79	4/10/20
80	5/10/20
81	6/10/20
82	7/10/20
83	8/10/20
84	9/10/20
85	10/10/20
86	11/10/20
87	12/10/20
88	1/10/21
89	2/10/21
90	3/10/21
91	4/10/21
92	5/10/21
93	6/10/21
94	7/10/21
95	8/10/21
96	9/10/21
97	10/10/21
98	11/10/21
99	12/10/21
100	1/10/22

SECTIONS & DETAILS

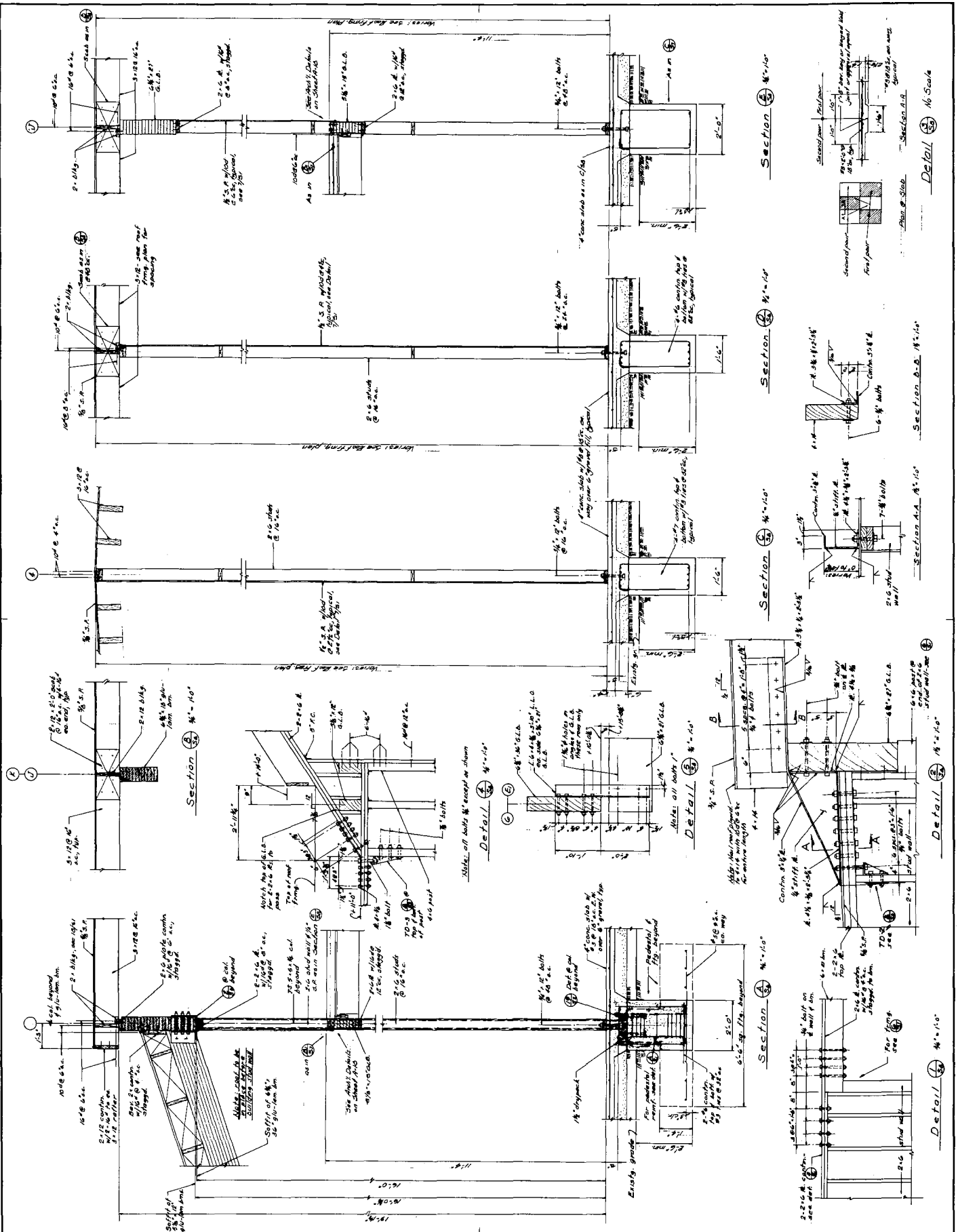



CAYWOOD NOPP WARD
 ARCHITECTS AND PLANNERS AIA
 310 MAIN STREET
 FARMERSVILLE, CA 95627
 916-222-7411

ROBERT J. GRAYFORD
 CONSULTING ENGINEER
 415 KENNEDY AVE
 SACRAMENTO, CA 95816
 916-427-7271

EL DORADO COUNTY GOVERNMENT CENTER
 SOUTH LAKE TAHOE BRANCH
 SOUTH LAKE TAHOE, SOUTH LAKE TAHOE, CALIFORNIA

DATE: 11/14/14
 DRAWN BY: [Signature]
 CHECKED BY: [Signature]
 PROJECT NO: 14-11-14

SECTIONS & DETAILS

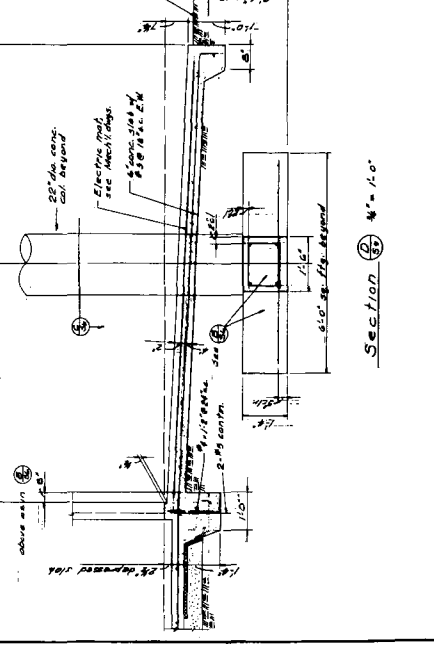
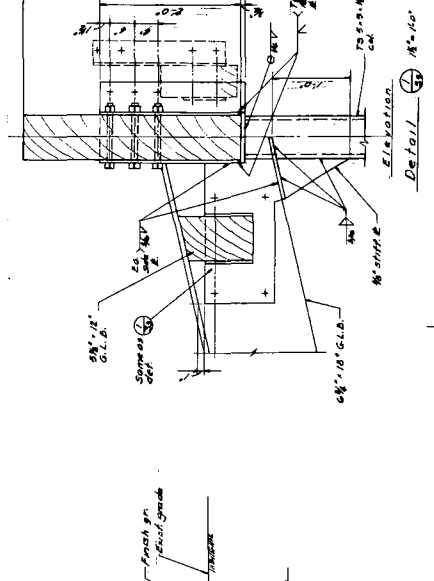
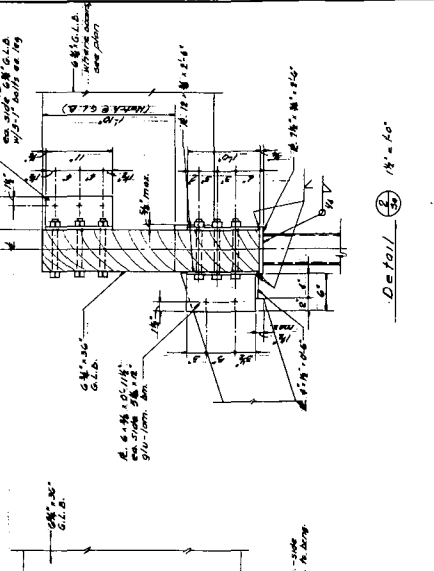
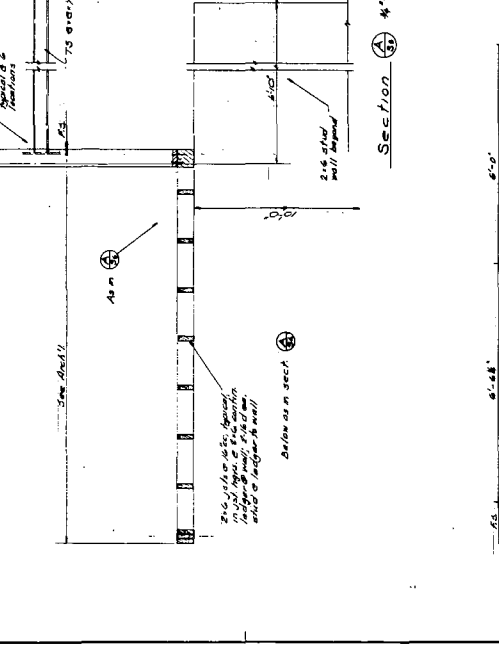
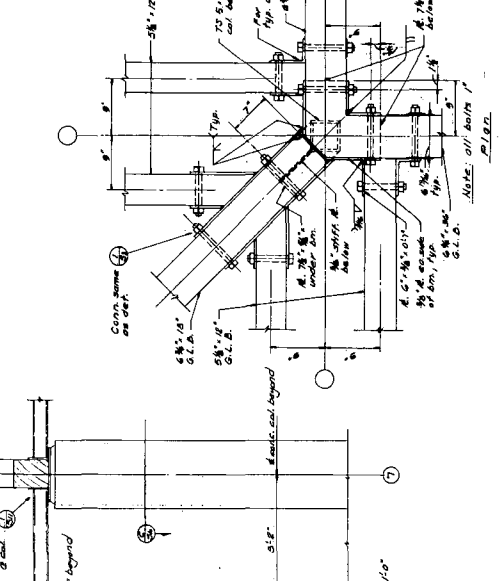
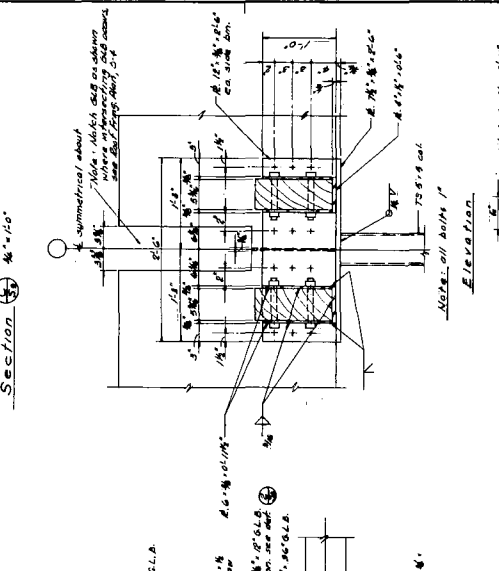
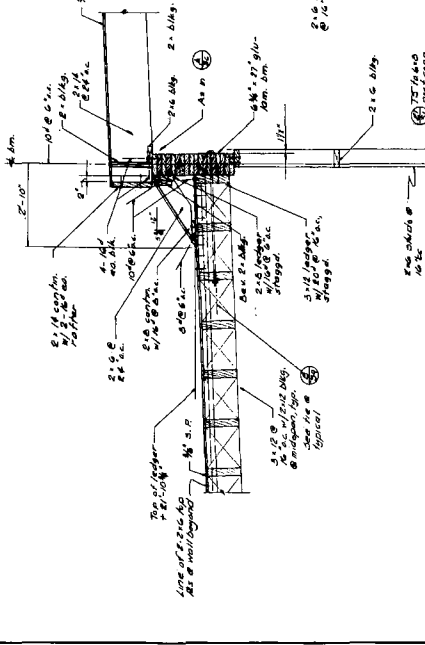
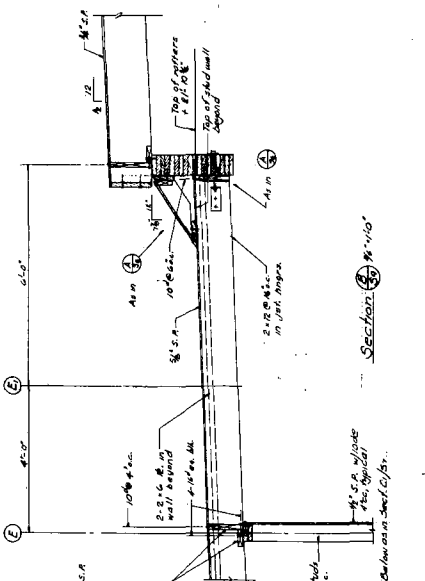
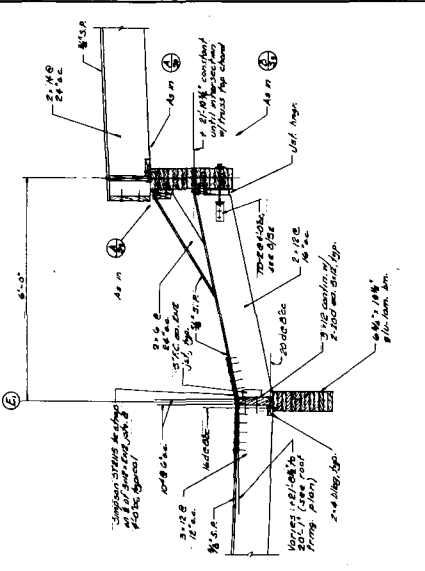

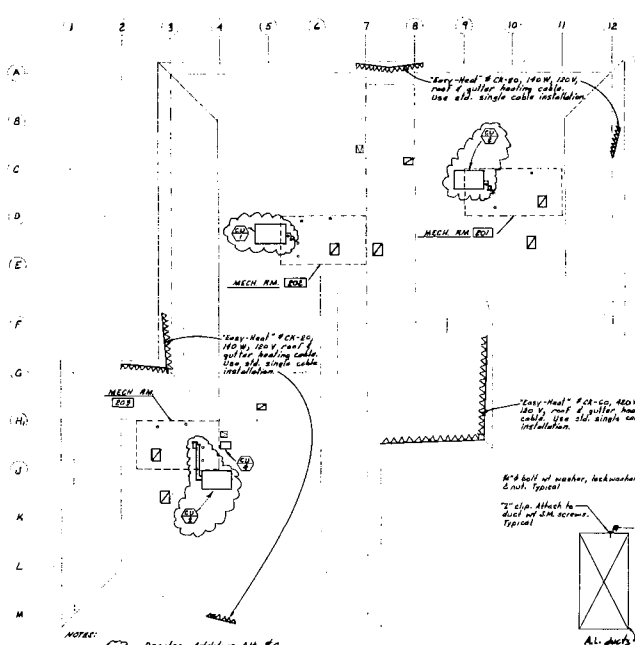

ROOF PLAN
Scale 1/8" = 1'-0"

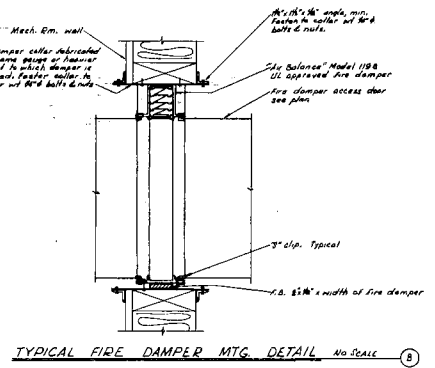

TYPICAL FIRE DAMPER MTG. DETAIL No Scale

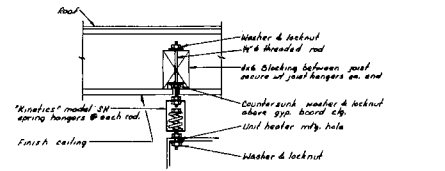

UNIT HEATER MTG. DETAIL No Scale

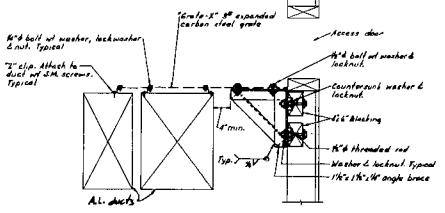

GRATE SUPPORT @ MECH. RM No Scale

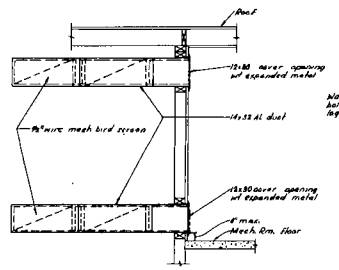

SECTION @ COMBUSTION AIR OPEN'GS Scale 1/4" = 1'-0"

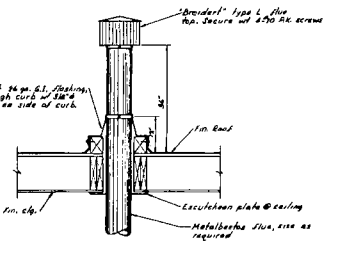

TYPICAL FLUE THRU ROOF DETAIL No Scale

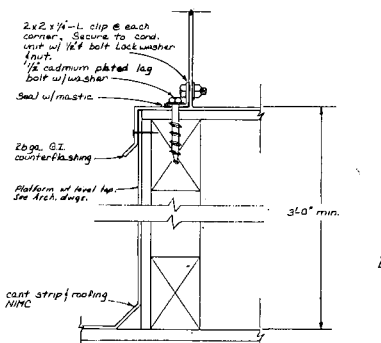

CU-4 MOUNTING DETAIL No scale

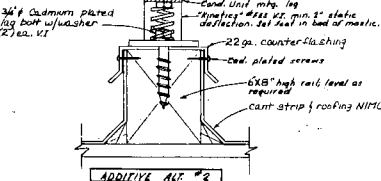

CU-1213 MOUNTING DETAIL No scale

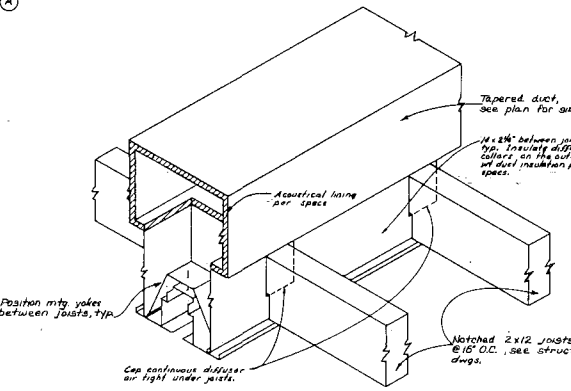

LINEAR DIFFUSER MOUNTING DETAIL No scale

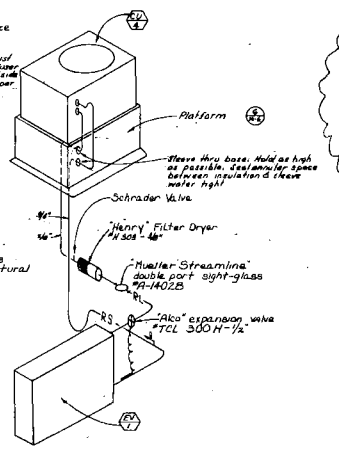

CU-4 REFRIGERANT PIPING DIAGRAM No scale

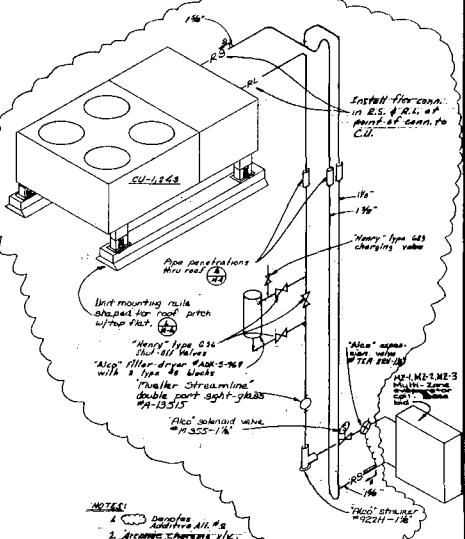

CU-1213 REFRIGERANT PIPING DIAGRAM No scale



CAYWOOD NOPP WARD
ARCHITECTS AND PLANNERS AIA
1425 Alameda Boulevard
Sacramento, CA 95818
916-452-7811

WIRE FILED FILE NO. 2017-0001
Mechanical Engineering
Sacramento, California
2/2/17
2/2/17
2/2/17

EL DORADO COUNTY GOVERNMENT CENTER
SOUTH LAKE TAHOE BRANCH
AL TAHOE BLVD & JOHNSON BLVD, SOUTH LAKE TAHOE, CALIFORNIA

REV: 1/17
Date & Appr'd By: [Signature]
OWNER: [Signature]
CHECK BY: [Signature]
DRAWN BY: [Signature]
JOB NO: 17-17-414

ROOF PLAN
DETAILS

TOTAL SHEETS: 45