

# Location Map

Cal.net El Dorado County  
North California Advanced Services  
Wireless Broadband Grant Project

S17-0004

 Site

# Site 10 Exhibit A

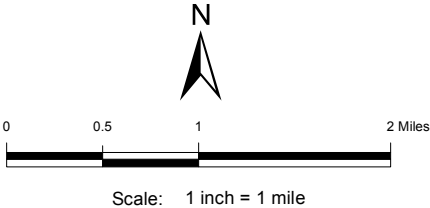

El Dorado County GIS Layers:  
Parcel Data (Downloaded: 22 June 2017)  
GPS Roads (2011)

SECS. 28 THRU 33, T.12N., R.11E., M.D.M.

62:11

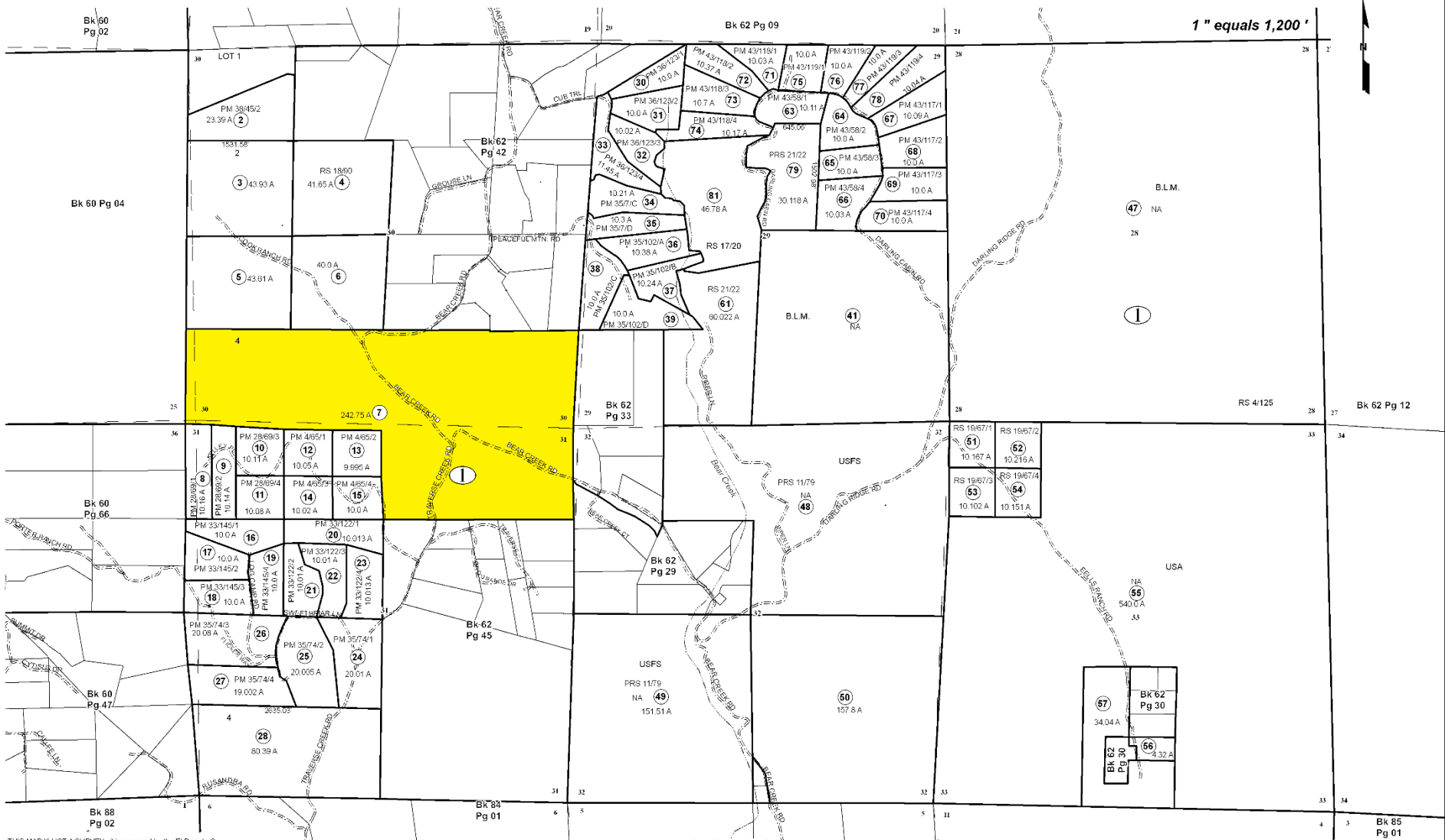

THIS MAP IS NOT A SURVEY. It is prepared by the El Dorado Co. Assessor's office for assessment purposes only. Area calculations and characteristics are not guaranteed. Users should verify items such as dimensions and acreage.

Acreages Are Estimates

Adjacent Map Pages Shown in Grey Text  
Assessor's Stock Numbers Shown in Circles  
Assessor's Parcel Numbers Shown in Squares

Rev. June 7, 2006

Assessor's Map Bk. 062, Pg. 11  
County of El Dorado, CA

Site 10 - Exhibit B

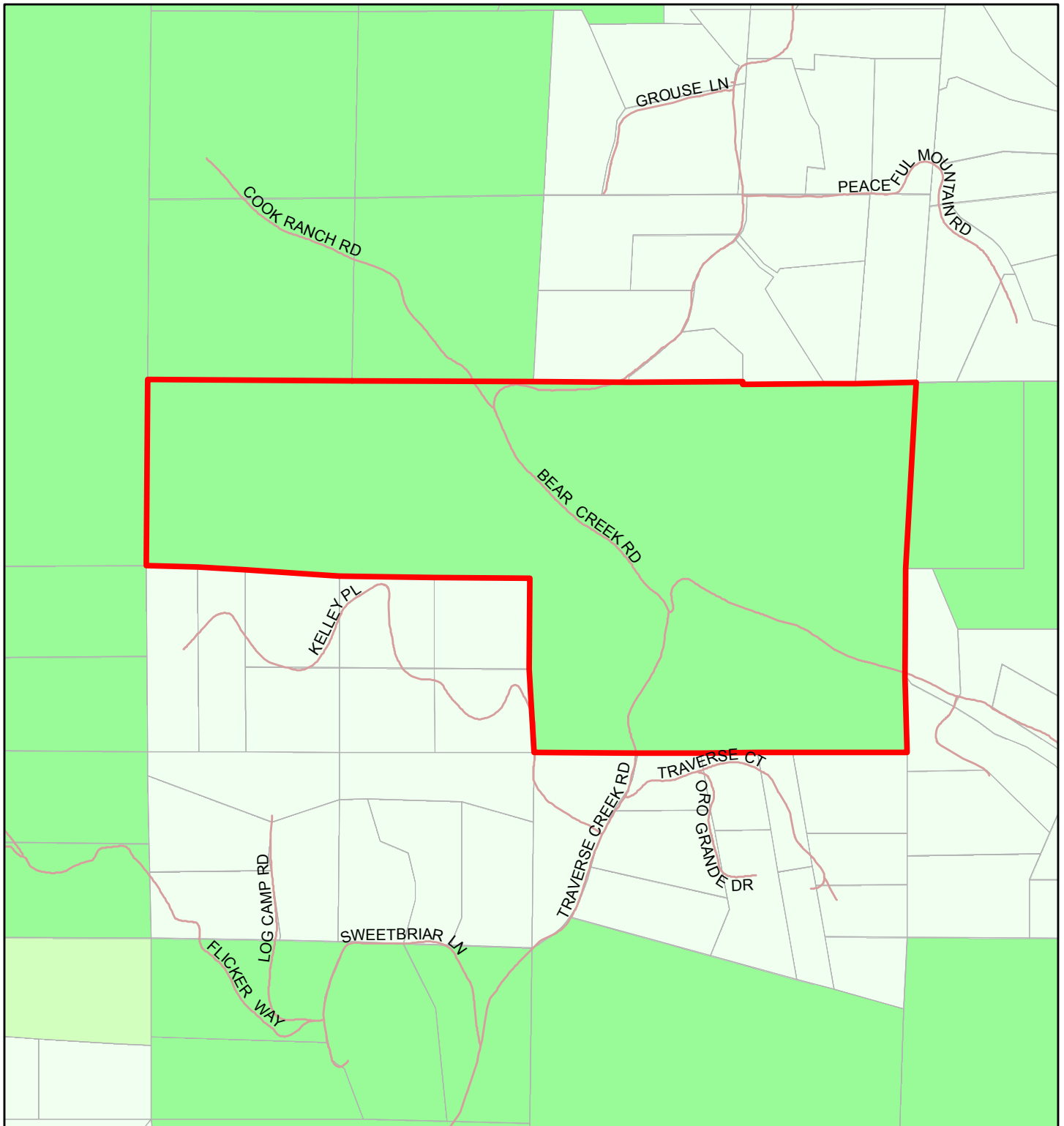

# Land Use Map

Cal.net El Dorado County  
 North California Advanced Services  
 Wireless Broadband Grant Project

S17-0004

- Site
- Agricultural Lands
- Natural Resources
- Rural Residential

## Site 10 Exhibit C

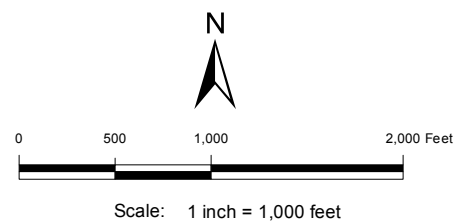







El Dorado County GIS Layers:  
 Parcel Data (Downloaded: 22 June 2017)  
 Base Land Use Layer (Downloaded: 26 June 2017)  
<http://gem.edc.gov.us/ugotnetextracts/>



# Zoning Map

Cal.net El Dorado County  
 North California Advanced Services  
 Wireless Broadband Grant Project

S17-0004

-  Site
-  FR-40 = Forest Resource 40 Acres
-  TPZ = Timber Preserve
-  RL-10 = Rural Land 10 Acres
-  RL-20 = Rural Land 20 Acres
-  RL-40 = Rural Land 40 Acres

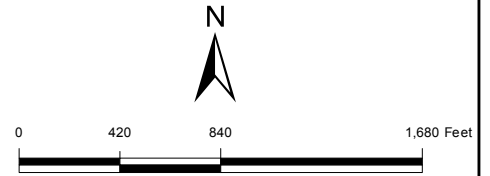

Scale: 1 inch = 800 feet

## Site 10 Exhibit D

El Dorado County GIS Layers:  
 Parcel Data (Downloaded: 22 June 2017)  
 Base Zoning Layer (Downloaded: 26 June 2017)  
<http://gem.edcgov.us/ugotnetextracts/>



# Aerial Photo

 Site / APN Boundary

Cal.net El Dorado County  
 North California Advanced Services  
 Wireless Broadband Grant Project

S17-0004

# Site 10 Exhibit E

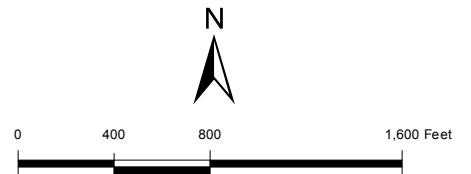

Scale: 1 inch = 800 feet

El Dorado County GIS Layers:  
 Parcel Data (Downloaded: 22 June 2017)  
<http://gem.edc.gov.us/ugotnetextracts/>  
 Aerial Photograph: 11 July 2017  
 NAIP2016 USDA FSA Imagery  
 ESRI Arcmap Basemap service layer

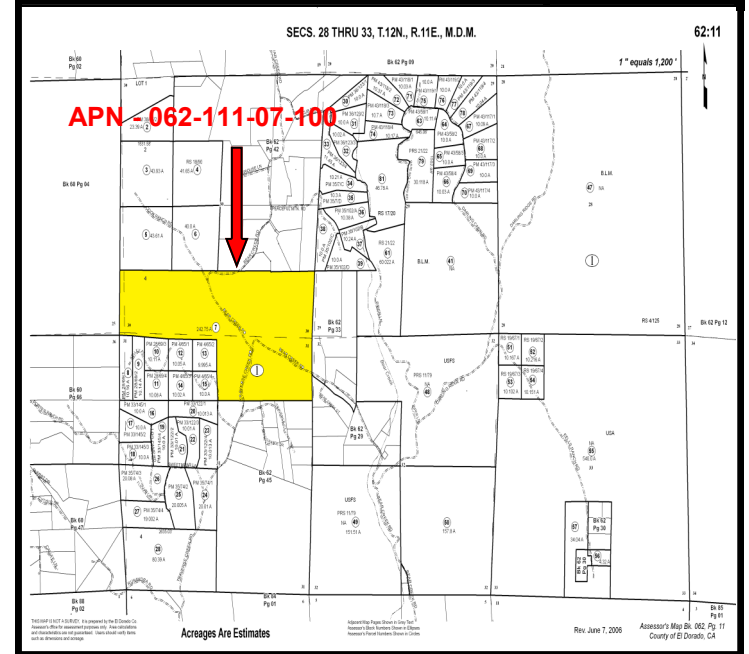
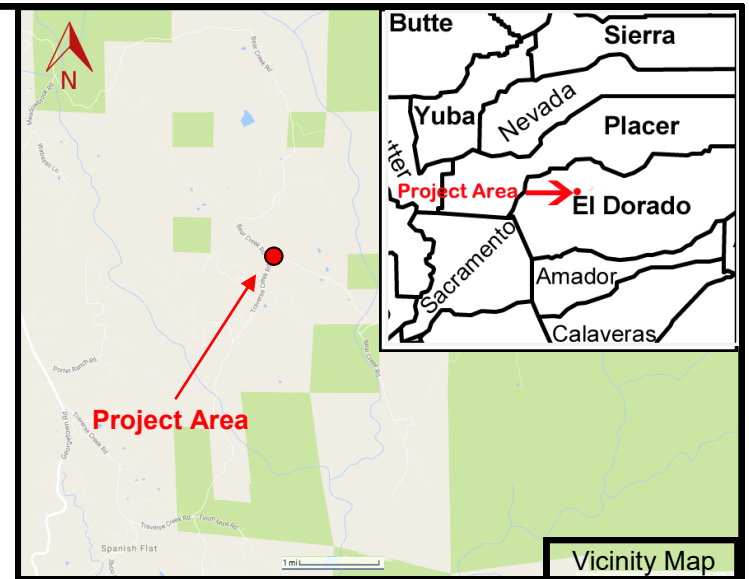

**Cal.net CASF Wireless Broadband Project** 1/3/2017  
 4101 Wild Chaparral Drive, Shingle Springs CA, 95682  
**Montillier Project Site - Site Plan**  
 4841 Traverse Creek Rd. Garden Valley, Ca 95633 **Cal.net**

**Site 10 - Exhibit F**



**Cal.net CASF Wireless Broadband Project**

1/3/2017

4101 Wild Chaparral Drive, Shingle Springs CA, 95682

**Montillier Project Site - Gates & Parking**

4841 Traverse Creek Rd. Garden Valley, Ca 95633



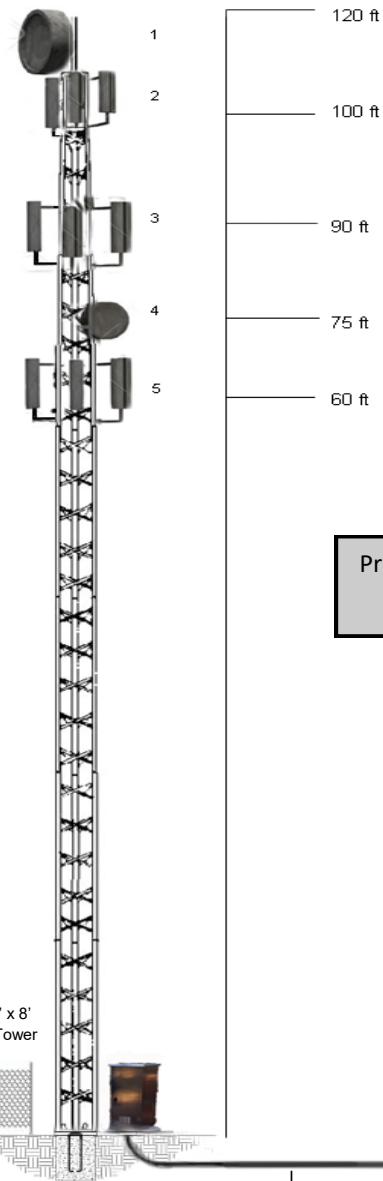

**Tower Antenna List**

1	Dragon Wave Licensed PTP
2	UBNT Sectors PTMP
3	Telrad Sectors PTMP
4	UBNT Dish Backhaul PTP
5	Carlson White Space PTMP

Proposed North Elevation

**Site 10 - Exhibit G**

not to scale

Grade Level  
0"-0" A.G.L.

Tower foundation to be specified by tower manufacture

Proposed 2" PVC SCH. 80/40 to Power Pole.

**Cal.net CASF Wireless Broadband Project**

1/3/2017

4101 Wild Chaparral Drive, Shingle Springs CA, 95682

**Montillier Project Site - Elevation**

4841 Traverse Creek Rd. Garden Valley, Ca 95633





**Tower Antenna List**

1	Dragon Wave Licensed PTP
2	UBNT Sectors PTMP
3	Telrad Sectors PTMP
4	UBNT Dish Backhaul PTP
5	Carlson White Space PTMP

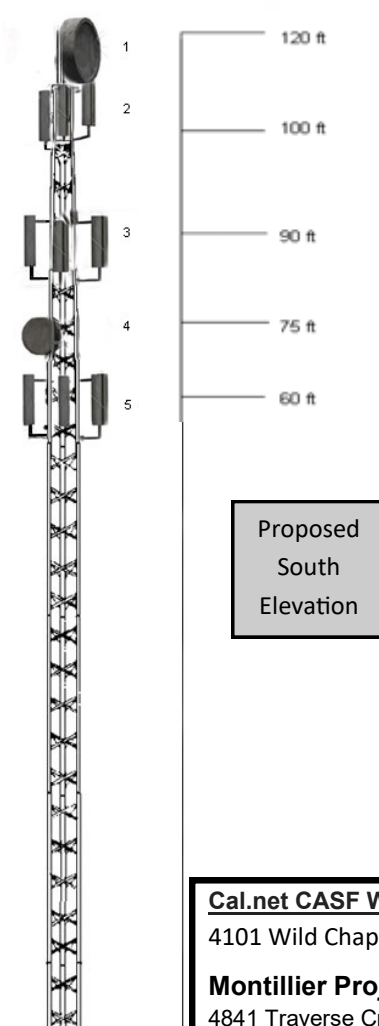
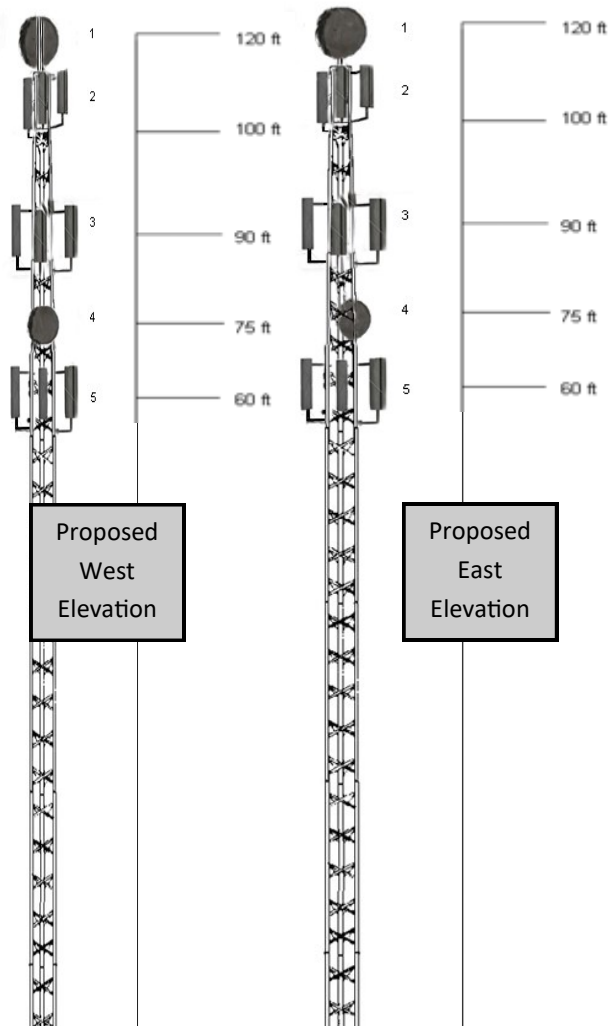

120FT H110 SUPERTITAN TOWER

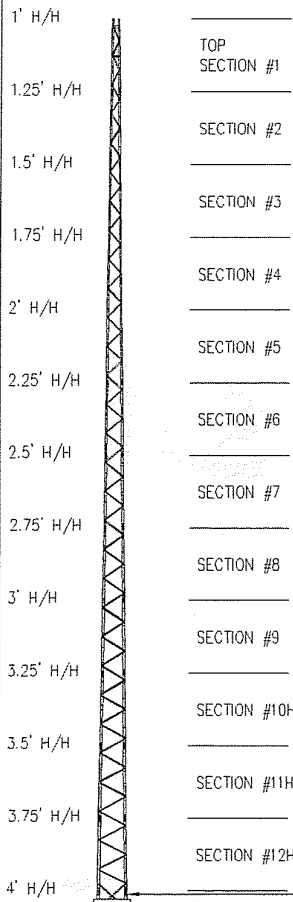

U S A	MAXIMUM ALLOWABLE ANTENNA AREA – PER TIA/EIA 222 REV. F					
	WIND VELOCITY RATINGS					
	NO ICE (ROUND/FLAT)			1/2" ICE (ROUND/FLAT)		
	70 mph	90 mph	100 mph	70 mph	90 mph	100 mph
	9/6	--/--	--/--	8/5	--/--	--/--

FOUNDATION LOADS:  
MAX. OVERTURNING MOMENT (K\*FT) =  
MAX. SHEAR (kips) =  
MAX. AXIAL (kips) =

U S A	MAXIMUM ALLOWABLE ANTENNA AREA – PER TIA/EIA 222 REV. G, CLASS 1 (NO ICE)					
	WIND VELOCITY RATINGS					
	90 mph 3sg		110mph 3sg		120 mph 3sg	
	75 mph FM		90 mph FM		100 mph FM	
	ROUND	FLAT	ROUND	FLAT	ROUND	FLAT
	--	--	--	--	--	--

3sg = 3 SECOND GUST WINDSPEED  
FM = FASTEST MILE WINDSPEED

FOUNDATION LOADS:  
MAX. OVERTURNING MOMENT (K\*FT) =  
MAX. SHEAR (kips) =  
MAX. AXIAL (kips) =

FOUNDATION DESIGN (NORMAL DRY SOIL)  
DESIGN ASSUMES THAT FROST DEPTH IS LESS THAN 4'-0"

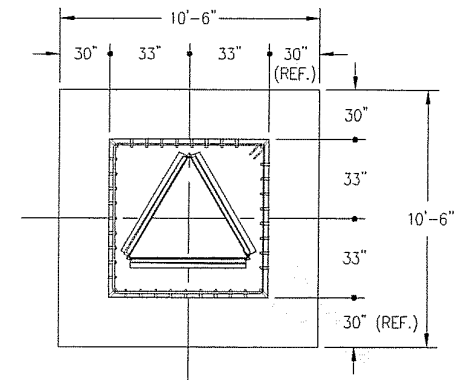
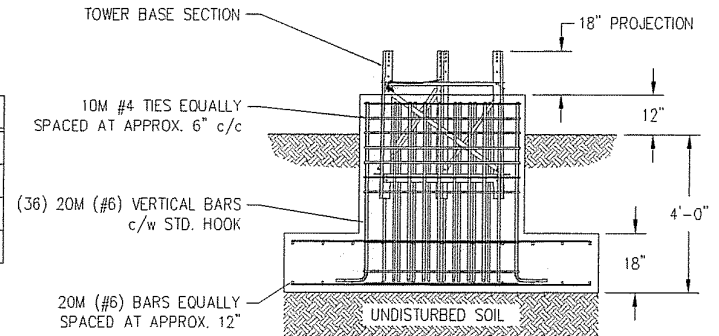

CUBIC YARDS OF CONCRETE		
PAD CONC VOL.	PIER CONC VOL.	TOTAL VOL.
6.1	3.9	10.0

CONFIDENTIAL: ALL INTELLECTUAL PROPERTY RIGHTS HEREIN ARE THE PROPERTY OF TRYLON MANUFACTURING COMPANY LTD. ALL DUPLICATION, RECORDING, DISCLOSURE OR USE IS PROHIBITED WITHOUT WRITTEN CONSENT OF TRYLON MANUFACTURING COMPANY LTD.



CUSTOMER:	SITE:	SCALE:
DATE: 13 apr 07	BY: MRH	CHK: APP:
TITLE: 120FT H110 SUPERTITAN TOWER	DRAWING NO. 000001.620.0437	

- NOTES: 1) KNOCK-DOWN PART NUMBER 5.94.H110.120.  
2) PRE-ASSEMBLED PART NUMBER: 5.95.H110.120.  
3) ANTENNA LOADS ARE CENTRALLY LOCATED AND BALANCED, 3-FT OR LESS ABOVE THE TOWER TOP.  
4) WND LOADING ASSUMES (1) 1/2" TRANSMISSION LINE PER 10 SQ.FT. OF ROUND MEMBER ANTENNA AREA.

REV.	REV. BY:	CHK. BY:	DESCRIPTION	DATE

Site 10 - Exhibit H

Cal.net CASF Wireless Broadband Project 1/3/2017  
4101 Wild Chaparral Drive, Shingle Springs CA, 95682  
Montillier Project Site - Tower Base  
4841 Traverse Creek Rd. Garden Valley, Ca 95633



## Appendix A - Antenna Specifications

### Antenna Specifications

Manufacturer	Model	Type	Height	Width	Depth	Weight	Flat Plate Area
RADIOWAVES	HP3-18	MICROWAVE DISH	38.0 IN	38.0 IN	30.2 IN	50.0 LBS	0.0 FT2
ALPHA WIRELESS LTD	AW3023	PANEL	29.5 IN	11.0 IN	3.3 IN	9.4 LBS	0.0
UBIQUITI NETWORK	5G-120-19	PANEL	27.56 IN	5.71 IN	3.11 IN	13.0 LBS	0.0
CARLSON WIRELESS	053-470-786-75-8	PANEL	17.0 IN	10.0 IN	9.5 IN	6.5 LBS	0.0

### Radiowaves Antenna 3 Foot Dish

#### HP3-18

0.9 M | 3 FT HIGH PERFORMANCE PARABOLIC REFLECTOR ANTENNA, SINGLE-POLARIZED, 17.7-19.7GHZ

The HP High Performance Series by RadioWaves offers a full line of high performance parabolic antennas engineered to provide ETSI class 2/3 radiation pattern performance as well as excellent gain. RadioWaves field-proven pre-assembled antennas and robust pole-mounts ensure "set and forget" installation with minimal post-installation maintenance. The included radome ensures robust and reliable performance under the most challenging conditions. If it's rugged, it must be RadioWaves!

#### FEATURES AND BENEFITS

- High Performance ETSI Class 2/3\* Parabolic Antennas – Excellent performance for a wide range of applications
- Fully Preassembled at the Factory – Simplifies installation on site and guarantees "factory-tested" quality
- Warranty – Industry leading 7-year warranty

\*ETSI Class depends on frequency band

#### SPECIFICATIONS

##### Mechanical

Fine Azimuth Adjustment	+/- 10 degrees	Mechanical Configuration	HP3
Fine Elevation Adjustment	+/- 10 degrees	Axial Force (FA)	403 lbs   1792 N
Mounting Pipe Diameter, Min	4.5 inch   11.4 cm	Side Force (FS)	200 lbs   890 N
Mounting Pipe Diameter, Max	4.5 inch   11.4 cm	Twisting Moment (MT)	344 ft-lbs   466 Nm
Net Weight	50 lbs   12.3 kg	Operating Temperature Range	-40 to +80 C
Wind Velocity Operational	90 mph   145 km/h	Max Pressure, PSIG, (if waveguide interface)	5
Wind Velocity Survival Rating	125 mph   201 km/h		

##### Regulatory Compliance

FCC	Part 101 Cat. A	ETSI	302217 R2 G3
Industry Canada Compliance	SRSP317.8 A	RoHS-compliant	Yes

##### Shipping Information

Package Type	Wood Crate	Dimensions, L x W x H	47 x 28 x 48in   119 x 71 x 122 cm
Gross Weight	143 lbs   69.8 kg	Shipping Volume	38.58 cu ft   1.04 cu m

Contact RadioWaves Sales for alternate RF interface options. RadioWaves specializes in direct connect solutions for microwave radars.

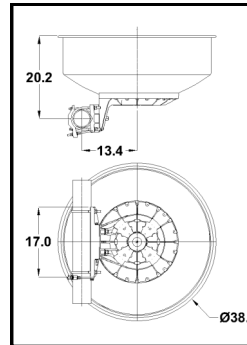
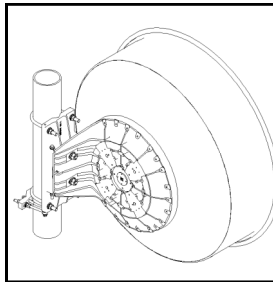

## Alpha Wireless/Telrad Panel/Sector Antenna

### AW3023 Data Sheet



#### 3300-3800MHz Sector Antenna

(Quad Port, 65° Beamwidth, +/-45° Polarisation, Fixed Tilt)

\*The parameters in this specification follow the definitions and recommendations per NGMN P-Basta, Release 9.6

#### Mechanical Specifications

Dimensions (LxWxD) mm (in) (inc RET.)	mm (in)	750 (29.5) x 280 (11) x 85 (3.3)
Packing Size (LxWxD)	mm (in)	823(32.4) x 340(13.3) x 178(7)
Net Weight (antenna)	kg (lb)	4.3 (9.4)
Net Weight (mount)	kg (lb)	1.57 (3.4)
Shipping Weight	kg (lb)	5.8 (12.8)
Connector Quantity	NA	4 x N Type Female
Connector Position	NA	Bottom
Windload calculation	km/h	F=1/2*p*(Cdp/A)*v <sup>2</sup> *A
Windload Frontal	N	420
Windload Lateral	N	120
Survival Wind Speed	km/h	200 (125)
Radome Material	NA	UV-Stabilised PVC
Radome Colour	RAL	7035
Product Compliance Environmental	NA	RoHS
Lightening Protection	NA	DC Grounded
Cold Temperature Survival	Celsius	-40
Hot Temperature Survival	Celsius	+70



### CL-V-104-M8 Data Sheet

#### M8 2.0mm, Standard Mount Kit

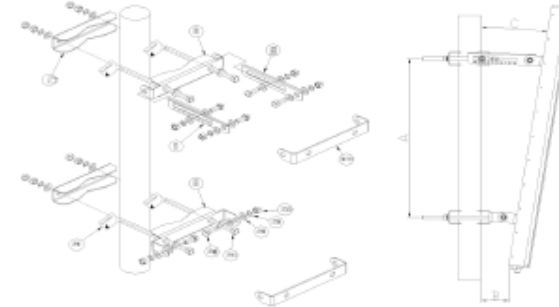

## Site 10 - Exhibit I

Cal.net CASF Wireless Broadband Project

1/3/2017

4101 Wild Chaparral Drive, Shingle Springs CA, 95682

Montillier Project Site - Antenna Specs

4841 Traverse Creek Rd. Garden Valley, Ca 95633



## Ubiquiti Sector Antenna

	Antenna Characteristics
Model	AM-5G19-120
Dimensions* (mm)	700 x 135 x 73
Weight**	5.9 kg
Frequency Range	5.15 - 5.85 GHz
Gain	18.6 - 19.1 dBi
HPOL Beamwidth	123° (6 dB)
VPOL Beamwidth	123° (6 dB)
Electrical Beamwidth	4°
Electrical Downtilt	2°
Max. VSWR	1.5:1
Wind Survivability	125 mph
Wind Loading	20 lbf @ 100 mph
Polarization	Dual-Linear
Cross-pol Isolation	28 dB Min.
ETSI Specification	EN 302 326 DN2
Mounting	Universal Pole Mount,

To mount the antenna to the pole, slide a *Pole Clamp* over each pair of *Carriage Bolts*. Secure each *Pole Clamp* with two *Serrated Flange Nuts*.

 **Note:** The mounting assembly can accommodate a Ø 40 mm - 80 mm pole.

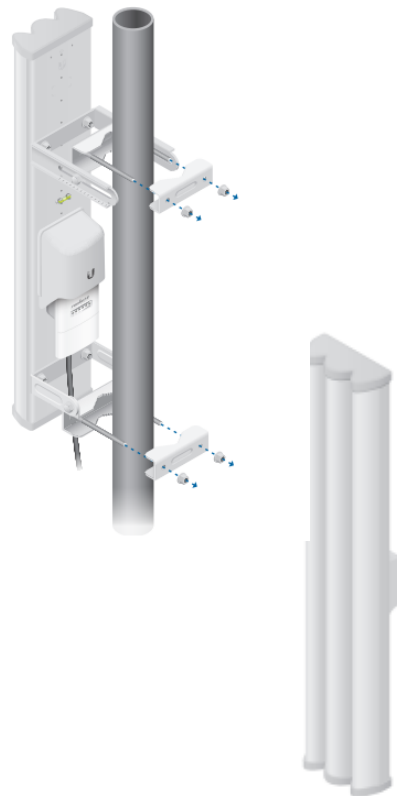

**AM-5G19-120**  
(5 GHz, 19 dBi)

\* Dimensions exclude pole mount and RocketM (RocketM sold separately)

\*\* Weight includes pole mount and excludes RocketM (RocketM sold separately)

## Carlson Panel/Sector Antenna



### Sector Antenna for RuralConnect

Frequency Range	470 - 790 MHz
Gain	8 dBi +0 -3, Over 120 Degrees Azimuth
VSWR	1:1.5
Active Elements	2 Bay, Modified Tapered Slot
Radiation Pattern	E plane: 120 degrees +0/-3 dB H plane: 30 degrees +/- 1 dB
Dimensions	9.5" x 17" x 10"
Front-to-Back Ratio	20 dB
Polarization	Vertical
Shipping Weight	8 lbs.
Carton Dimensions	10" x 18" x 12"
Connector	F male with 3' pigtail
Impedance	75 ohm
Materials	Aluminum, Stainless Steel, Polycarbonate
Operating Temp.	-60 to 75 degrees Celsius
Wind Surface Area	Surface Area 100 mph 120 mph
with no ice	2.4 sq ft. 61.6 lbs 88.8 lbs
with 1/2 in. ice	2.9 sq ft. 76.1 lbs 109.6 lbs

Custom designed for the Generation 3 RuralConnect, this antenna has high gain over nearly a 2:1 wide band with a 120 degree azimuth coverage. This antenna is fully operational in all climates from tropical to arctic with a weatherproof polycarbonate cover. The high front-to-back ratio is an important feature for use in multiple antenna base sites. The antenna does not require any tuning or adjustments over the entire UHF TV band.

The antenna comes equipped with a 3-foot RF lead, fixed at the rear of the mounting pipe.

Stainless steel mounting brackets to fit 1-inch to 2-inch NPT masts are included.

Carlson Part Number  
75 ohm: 053-470-786-75-8

*US Patent Pending*



Carlson Wireless Technologies, Inc.  
2700 Foster Avenue  
Arcata, CA 95521 USA

T: +1 707.822.7000  
F: +1 707.822.7010  
E: info@carlsonwireless.com

Specs subject to change without notice  
Last Updated: 10-9-16

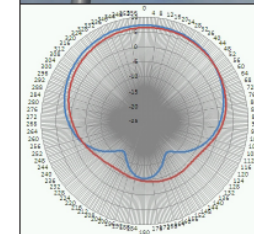

**UPS Shippable!**



"UPS in shield design is a registered trademark of United Parcel Service of America, Inc. used by permission."

**Cal.net CASF Wireless Broadband Project**

1/3/2017

4101 Wild Chaparral Drive, Shingle Springs CA, 95682

**Montillier Project Site - Antenna Specs**

4841 Traverse Creek Rd. Garden Valley, Ca 95633

**Cal.net**

## Ubiquiti Power Beam Dish Antenna

### Specifications

PBE-5AC-500-ISO	
Dimensions (with Radome)	564 x 564 x 308 mm (22.20 x 22.20 x 12.13")
Weight (Mount Included)	5.2 kg (11.5 lb)
Operating Frequency	Worldwide: 5150 - 5875 MHz USA: 5725 - 5850 MHz
Gain	27 dBi
Networking Interface	(1) 10/100/1000 Ethernet Port
Enclosure	Outdoor UV Stabilized Plastic
Max. Power Consumption	8W
Power Supply	24V, 0.5A Gigabit PoE Adapter (Included)
Power Method	Passive PoE (Pairs 4, 5+; 7, 8 Return)
Wind Survivability	200 km/h (125 mph)
Wind Loading	984 N @ 200 km/h (221.2 lbf @ 125 mph)
Certifications	CE, FCC, IC
Mounting	Pole Mounting Kit Included
Operating Temperature	-40 to 70° C (-40 to 158° F)
Operating Humidity	5 to 95% Noncondensing
Shock and Vibrations	ETSI300-019-1.4

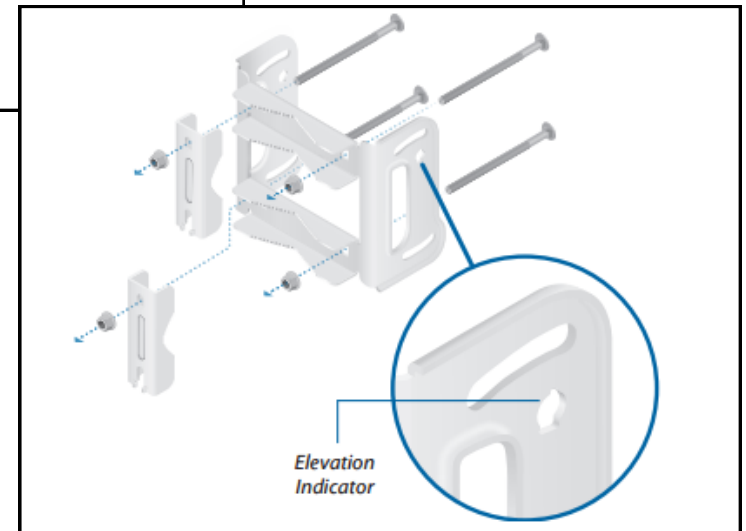
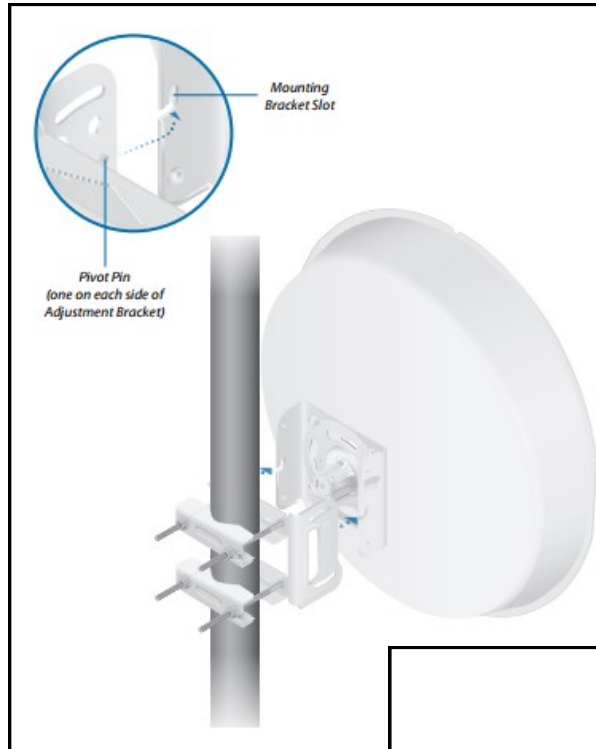

Cal.net CASF Wireless Broadband Project

1/3/2017

4101 Wild Chaparral Drive, Shingle Springs CA, 95682

Montillier Project Site - Antenna Specs

4841 Traverse Creek Rd. Garden Valley, Ca 95633

Cal.net

# Antenna Mounting Brackets

ITEM NO.	PART NUMBER	DESCRIPTION	QTY.
1	Galv Standard V Block		4
2	Tower Mount Bar 3		2
3	1.25 x 48 in pipe		1
4	Tower Mount Short Bandsteel		2
5	.375-1.5 Hex Bolt	.375-1.5 Hex Bolt	4
6	.375 Flat Washer Galv	.375 Flat Washer Galv	4
7	.375 Split Lock Washer Galv	.375 Split Lock Washer Galv	4
8	.5-13-6 Hex Bolt	.5-13-6 Hex Bolt	4
9	.5 Flat Washer Galv	.5 Flat Washer Galv	4
10	.5 Galv Lock Washer	.5 Galv Lock Washer	4
11	.5-13 Hex Nut	.5-13 Hex Nut Galv	4
12	.375-16 Hex Nut Galv	.375-16 Hex Nut Galv	4

**PROPRIETARY AND CONFIDENTIAL**  
THE INFORMATION CONTAINED IN THIS DRAWING IS THE SOLE PROPERTY OF MONTILLIER PROJECT SITE. ANY REPRODUCTION OR TRANSMISSION OF THIS INFORMATION WITHOUT THE WRITTEN PERMISSION OF MONTILLIER PROJECT SITE IS PROHIBITED.

UNLESS OTHERWISE SPECIFIED:  
DIMENSIONS ARE IN INCHES  
TOLERANCES  
FINISHES  
MATERIALS  
METHODS OF FABRICATION  
SURFACE TREATMENTS  
PINS  
G.A.  
COMMENTS

WEIGHT: 15.3 LBS  
MATERIAL: STEEL  
FINISH: HOT DIP GALV  
DO NOT SCALE DRAWING

DATE: 1/15/07  
DRAWN: CM  
CHECKED: CM  
ENG. APPR.:  
MFG. APPR.:  
G.A.:  
COMMENTS:

TITLE: M-TOW-P-48  
SIZE: B  
DWG. NO.: M-TOW-P-48  
REV: A  
SCALE: 1:1 WEIGHT: SHEET 1 OF 1

**PROPRIETARY AND CONFIDENTIAL**  
THE INFORMATION CONTAINED IN THIS DRAWING IS THE SOLE PROPERTY OF MONTILLIER PROJECT SITE. ANY REPRODUCTION OR TRANSMISSION OF THIS INFORMATION WITHOUT THE WRITTEN PERMISSION OF MONTILLIER PROJECT SITE IS PROHIBITED.

UNLESS OTHERWISE SPECIFIED:  
DIMENSIONS ARE IN INCHES  
TOLERANCES  
FINISHES  
MATERIALS  
METHODS OF FABRICATION  
SURFACE TREATMENTS  
PINS  
G.A.  
COMMENTS

WEIGHT: 5.2 LBS  
MATERIAL: Carbon Steel  
FINISH: Hot Dip Galv  
DO NOT SCALE DRAWING

DATE: 1/15/07  
DRAWN: CM  
CHECKED: CM  
ENG. APPR.:  
MFG. APPR.:  
G.A.:  
COMMENTS:

TITLE: M-TOW-FACE-26 Product Spec  
SIZE: B  
DWG. NO.: M-TOW-FACE-26 Product Spec  
REV: A  
SCALE: 1:1 WEIGHT: SHEET 1 OF 1

**PROPRIETARY AND CONFIDENTIAL**  
THE INFORMATION CONTAINED IN THIS DRAWING IS THE SOLE PROPERTY OF MONTILLIER PROJECT SITE. ANY REPRODUCTION OR TRANSMISSION OF THIS INFORMATION WITHOUT THE WRITTEN PERMISSION OF MONTILLIER PROJECT SITE IS PROHIBITED.

UNLESS OTHERWISE SPECIFIED:  
DIMENSIONS ARE IN INCHES  
TOLERANCES  
FINISHES  
MATERIALS  
METHODS OF FABRICATION  
SURFACE TREATMENTS  
PINS  
G.A.  
COMMENTS

WEIGHT: 15.3 LBS  
MATERIAL: STEEL  
FINISH: HOT DIP GALV  
DO NOT SCALE DRAWING

DATE: 1/15/07  
DRAWN: CM  
CHECKED: CM  
ENG. APPR.:  
MFG. APPR.:  
G.A.:  
COMMENTS:

TITLE: M-TOW-P-24  
SIZE: B  
DWG. NO.: M-TOW-P-24  
REV: A  
SCALE: 1:1 WEIGHT: SHEET 1 OF 1

**PROPRIETARY AND CONFIDENTIAL**  
THE INFORMATION CONTAINED IN THIS DRAWING IS THE SOLE PROPERTY OF MONTILLIER PROJECT SITE. ANY REPRODUCTION OR TRANSMISSION OF THIS INFORMATION WITHOUT THE WRITTEN PERMISSION OF MONTILLIER PROJECT SITE IS PROHIBITED.

UNLESS OTHERWISE SPECIFIED:  
DIMENSIONS ARE IN INCHES  
TOLERANCES  
FINISHES  
MATERIALS  
METHODS OF FABRICATION  
SURFACE TREATMENTS  
PINS  
G.A.  
COMMENTS

WEIGHT: 5.2 LBS  
MATERIAL: Carbon Steel  
FINISH: Hot Dip Galv  
DO NOT SCALE DRAWING

DATE: 1/15/07  
DRAWN: CM  
CHECKED: CM  
ENG. APPR.:  
MFG. APPR.:  
G.A.:  
COMMENTS:

TITLE: M-TOW-6  
SIZE: B  
DWG. NO.: M-TOW-6  
REV: A  
SCALE: 1:1 WEIGHT: SHEET 1 OF 1

**Cal.net CASF Wireless Broadband Project** 1/3/2017  
 4101 Wild Chaparral Drive, Shingle Springs CA, 95682  
**Montillier Project Site - Mount Specs**  
 4841 Traverse Creek Rd. Garden Valley, Ca 95633



# Site 10 - Exhibit J



Existing

Photo simulation of view looking east in driveway.



Proposed



Existing

Looking northeast from Traverse Creek Road



Tower

Proposed

*Approximately 15 feet of the tower is visible from Traverse Creek Road 0.25 mile southwest from the tower. The tower is visible for approximately 0.07 mile traveling north, then east on Bear Creek Road. Traveling west on Bear Creek Road for about 0.36 mile, the tower is visible from the approximately 150 feet of roadway that is not lined by trees.*

**Cal.net CASF Wireless Broadband Project** 1/3/2017  
**Site 10 - Site Plan**  
4841 Traverse Creek Rd.  
Garden Valley, Ca 95633





# Site 10 - Exhibit K

## Cal.net, Inc. – Proposed Fixed Wireless Communications Facility Site Name: Montillier 4841 Traverse Creek Rd., Garden Valley, CA 95633

### 1. Introduction

Cal.net, Inc., a fixed-wireless Internet service provider, is proposing to install a group of antennae on a new tower located at 4841 Traverse Creek Rd., Garden Valley, CA 95633 (APN # 062-111-07). These antennae will enable the delivery of high-speed wireless Internet service to the Northern El Dorado County area, in fulfillment of the mandates of an infrastructure grant awarded to Cal.net by the California Public Utilities Commission in 2016.

This report is an analysis of the radio frequency (“RF”) environment surrounding the proposed installation. This report shall serve to ensure compliance with the appropriate guidelines of the Federal Communications Commission (“FCC”) limiting human exposure levels to RF energy.

### 2. Site & Equipment Configuration

A Fixed Wireless communications facility is composed of two basic types of radio equipment:

- a) Point-to-Multipoint (“P2MP”) *base-station* radios that each communicate with multiple end-user (customer premise equipment – or “CPE”) radios, and
- b) Point-to-Point (“P2P”) *backhaul* radios that carry the aggregated data traffic among all the base station radios at a site to and from the company’s operations center.

All radio equipment comprises two fundamental components – active electronic transceivers that send and receive radio signals, and passive antennae that amplify the sent & received signals and concentrate them in specific directions. For radio transmissions, the FCC sets certain limits on the transmission power of each type of radio – these power limits are defined in terms of the Equivalent Isotropic Radiated Power (“EIRP”).

The P2MP base station equipment we utilize comprises three different technologies and radio-frequency bands:

- a) The Unlicensed National Information Infrastructure (U-NII) band operates at frequencies between 5.180 GHz – 5.845 GHz in the United States. There are several sub-bands of the U-NII band that have varying maximum FCC power limits ranging between 1 Watt and 4 Watts EIRP for P2MP uses. The antennae used for these radios are flat-panel “sector” antennae 6” wide by 28” high, and concentrate the radio signal into beam that’s 4 degrees thick in the vertical plane. The outdoor transceiver mounts directly onto the rear of the antenna, and is connected to a data switch at the base of the facility via a shielded Ethernet cable, which also supplies the power to the device.
- b) The Citizens Broadband Radio Service (“CBRS”) band operates at FCC-licensed frequencies between 3.55 GHz – 3.70 GHz. The FCC defines power limits in this band as a function of the width of the frequency band used by the transmitter. At the nominal 10-MHz bandwidth, the power limit in rural areas is 47 dBm (about 50.12 Watts) EIRP. The antennae used for these radios are flat-panel “sector” antennae 11” wide by 30” high, with a 7-degree-thick vertical beamwidth. The outdoor transceiver is typically mounted adjacent to or nearby the antenna with a short coaxial cable connecting them. The transceiver is also connected to a data switch at the base of the facility via a shielded Ethernet cable. A separate low-voltage DC power cable powers the transceiver.
- c) The Television White Space (“TVWS”) band operates at frequencies between 470 MHz – 698 MHz in the United States (aka UHF TV channels 14 – 51). For rural areas, the FCC defines the maximum transmit power as 10 Watts EIRP. The antennae used for these radios are blade-type “sector” antennae 10” deep by 17” high, with a 30-degree-thick vertical beamwidth. The outdoor transceiver is typically mounted adjacent to or nearby the antenna with a short coaxial cable connecting them. The transceiver is also connected to a data switch at the base of the facility via a shielded Ethernet cable, which also supplies the power to the device.

The P2P backhaul equipment we utilize consists of a radio operating in the FCC-licensed 18-GHz band (17.7 – 19.7 GHz). The outdoor transceiver mounts directly to the back of a 3-foot diameter parabolic reflector (“dish”) antenna, and is connected to a data switch at the base of the facility via a shielded Ethernet cable. A separate low-voltage DC power cable powers the transceiver. The radio transmits at a power of 575 Watts EIRP, but the dish antenna concentrates that power into a conical beam only 1.3 degrees in width.

All radios will be mounted upon the facility at an effective height of approximately 34 meters above ground.

### 3. FCC Human Exposure Standards

The Federal Communications Commission has established guidelines concerning the maximum safe human exposure limits to electromagnetic fields. Docket 93-62, effective October 15, 1997, is based on exposure limits recommended by the National Council on Radiation Protection and Measurements (NCRP). It specifies separate occupational and general public exposure limits, with the latter being five times more restrictive. These limits are based on continuous exposures and are intended to provide a prudent margin of safety for all persons, without regard to physical characteristics.

The table below, with the accompanying graph, depicts the FCC limits for occupational and public exposure conditions at different radio frequencies:

Frequency Range (MHz)	Electromagnetic Fields ("f" is frequency of emission in MHz)					
	Occupational Exposure			General Public Exposure		
	Electric Field Strength (V/m)	Magnetic Field Strength (A/m)	Power Density (mW/cm <sup>2</sup> )	Electric Field Strength (V/m)	Magnetic Field Strength (A/m)	Power Density (mW/cm <sup>2</sup> )
0.3 – 1.34	614	1.63	100	614	1.63	100
1.34 – 3.0	614	1.63	100	823.8 / f	2.19 / f	180 / f <sup>2</sup>
3.0 – 30	1842 / f	4.89 / f	900 / f <sup>2</sup>	823.8 / f	2.19 / f	180 / f <sup>2</sup>
30 – 300	61.4	0.163	1.0	27.5	0.0729	0.2
300 – 1,500	3.54 · f <sup>1/2</sup>	f <sup>1/2</sup> / 109	f / 300	1.59 · f <sup>1/2</sup>	f <sup>1/2</sup> / 238	f / 1500
1500 – 100,000	137	0.364	5.0	61.4	0.163	1.0

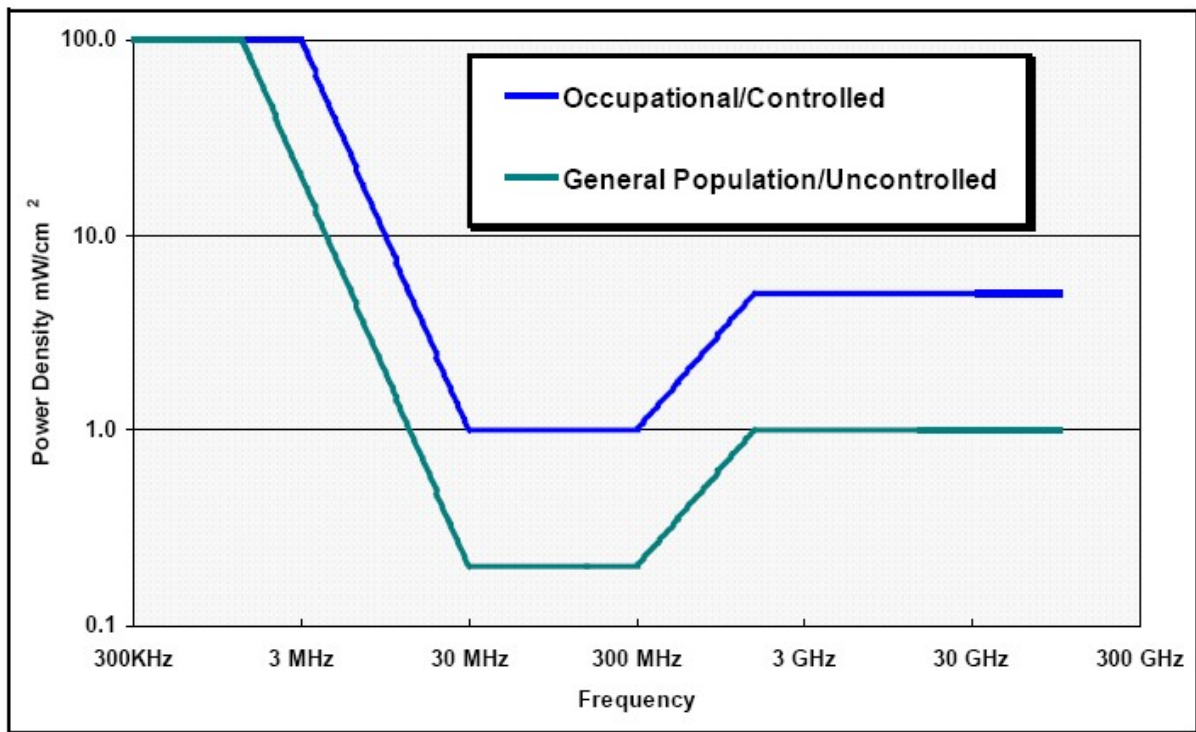

FCC Adopted Maximum Permissible Exposure Limits

#### 4. Calculation and Analysis Assessment

Methods have been developed for predicting the field strength of antennas in two distinct zones. The near field zone is defined as the distance beyond which the manufacturer's published far field antenna radiation patterns will be fully formed. The near field applies at increasing distances, R, until all of the following three conditions have been met, beyond which the far field applies:

$$R > 2h^2 / \lambda ; \quad R > 5h ; \quad R > 1.6 \lambda$$

where:

R = The depth of the near field, in meters

h = Aperture height of the antenna, in meters

$\lambda$  = wavelength of the transmitted signal, in meters

Power density is a measure of power divided by the surface area of the sphere or the unit area normal to the direction of propagation, usually expressed in units of milliwatts per square centimeter (mW/cm<sup>2</sup>) or watts per square meter (W/m<sup>2</sup>).

The near-field power density of a radio transmitter is dependent on the type of antenna – either an “aperture antenna”, or not. For our purposes, the microwave backhaul parabolic dishes are aperture antennae, and all other antennae we use are not.

The maximum near-field power density of an aperture antenna is defined as:

$$S = (16 \times \eta \times P_{\text{net}}) / (\pi h^2)$$

The near-field power density of all other antenna types is defined as:

$$S = (180 / \Theta_{\text{BW}}) \times P_{\text{net}} / (\pi R \times h)$$

At ground level, the far-field power density of a radio transmitter is defined as:

$$S = (\text{EIRP} \times \text{RFF}^2 \times \text{GRC}^2) / (4\pi R^2)$$

where:

S = Power Density (mW/cm<sup>2</sup>)

$\eta$  = aperture efficiency (unitless, typically 0.5 – 0.8)

$P_{\text{net}}$  = net power input to the antenna, in milliwatts

h = height of the antenna, in centimeters

$\Theta_{\text{BW}}$  = half-power beamwidth of the antenna, in degrees

R = Straight-line distance from the center of radiation to the point of calculation, in centimeters

EIRP = Equivalent Isotropic Radiated Power, the maximum antenna power output (mW) (note that EIRP is 64% higher than the half-wave dipole ERP)

RFF = Relative Field Factor, the amount of EIRP reduction in the vertical plane, applicable at downward angles to a human standing on the ground, derived from the antenna vertical radiation pattern

GRC = Ground Reflection Coefficient, which accounts for the increase in power density at a point due to reflection off the ground

Power density, electric field strength, and magnetic field strength are related in the following manner:

$$S = E^2 / Z_0 = Z_0 H^2$$

where:

S = Power Density (W/m<sup>2</sup>)

E = Electric Field Strength (V/m)

H = Magnetic Field Strength (A/m)

$Z_0$  = Impedance of Free Space (= 376.7  $\Omega$ )

## **5. Results**

The calculation of exposure to ionizing radiation utilizes a worst-case scenario approach, presuming a location on the ground in the direction of maximum radiated energy – specifically along the centerline of the backhaul dish antenna. The base station radios at the site point in a variety of directions, but for the worst-case scenario we will stipulate a maximum of 2 U-NII radios, 2 LTE radios, and 1 TVWS radios all pointing in the same direction as the backhaul dish.

The minimum safe public exposure distance in front of the dish antenna is 3.42 meters (11.2 feet). The total safe distance is 3.81 meters (12.5 feet) for all combined radios. Both of these distances are shorter than the height above ground at which the radio is mounted. Additionally, the transmission characteristics of the 18-GHz band of the backhaul radio requires clear line of sight to the opposite side of the link, and it is thus oriented in such a manner to avoid all possible obstruction by physical objects, whether stationary or mobile. Accordingly, a ground location for this worst-case scenario approach is appropriate.

For a person anywhere on the ground, at the closest possible point to the antennae in the direction of maximum exposure, the maximum power density energy level will be 0.001311 mW/cm<sup>2</sup> for the microwave devices, and 0.000159 mW/cm<sup>2</sup> for the TVWS devices. This power density is approximately 0.13% of the recommended limit at microwave frequencies, and 0.04% of the recommended limit at UHF frequencies. Any location beyond the closest ground point would have a correspondingly lower power density, declining in proportion to the square of the distance from the antenna. For occupational purposes, the exposure percentages are one-fifth those of the respective public limits (the radiation limits are five times higher than the public limits).

## **6. Conclusion**

Due to their mounting locations, no Cal.net antennae will be accessible to the general public, and their height above ground will prevent unsafe radiation levels for anyone in the vicinity. The highest calculated level in publicly accessible areas is much less than the prevailing standards allow for exposures of unlimited duration. Accordingly, no mitigation measures are necessary to comply with the FCC public exposure guidelines. With respect to Cal.net employees, they are adequately trained to take appropriate measures to avoid exposures exceeding the occupational limits, and the company will ensure that its employees and contractors will comply with FCC occupational exposure limits whenever working near the antennae themselves.