

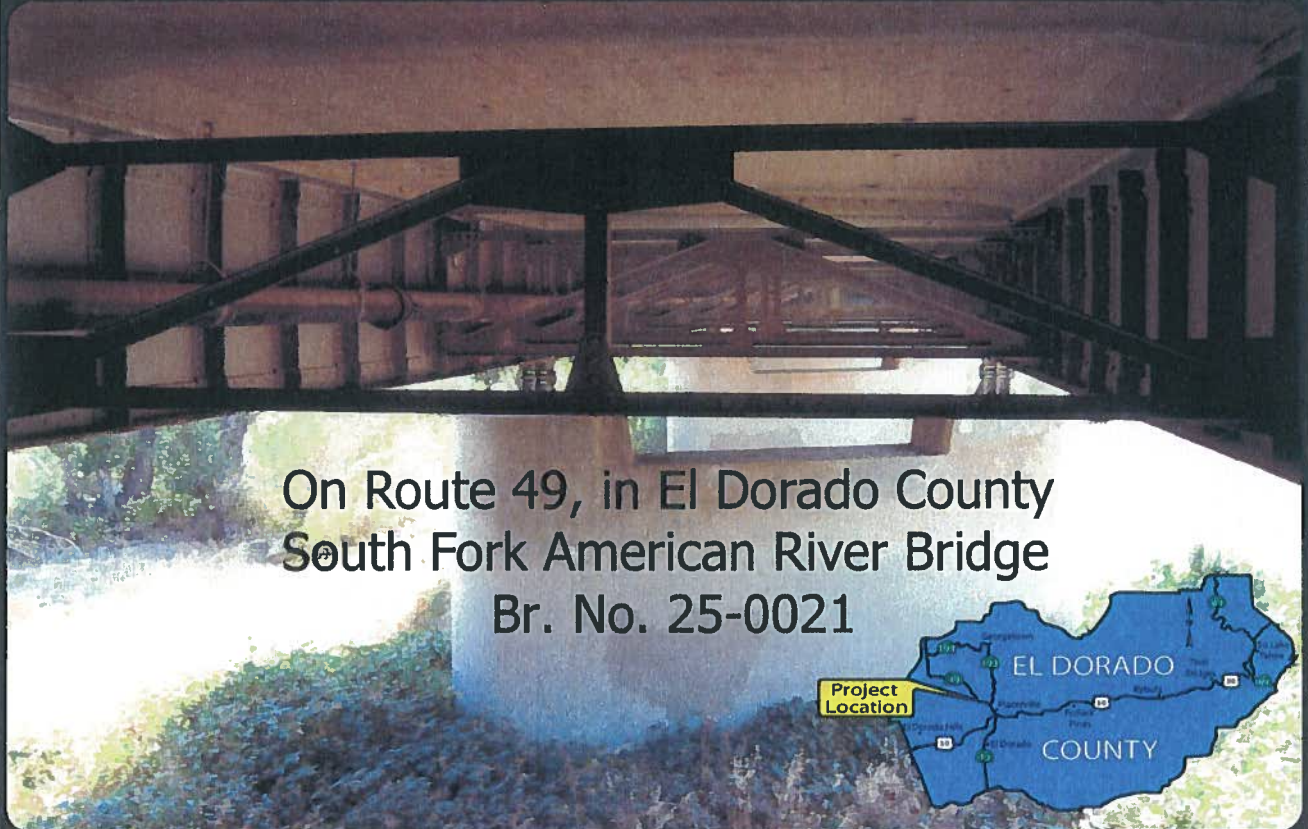

03-ED-49 PM 24.0
03-216-0F310K
20.XX.201.113
January 2010

PROJECT SCOPE SUMMARY REPORT (Seismic Retrofit)



On Route 49, in El Dorado County
South Fork American River Bridge
Br. No. 25-0021



I have reviewed the right of way information contained in this Project Scope Summary Report and the R/W Data Sheet attached here to, and find the data to be complete, current and accurate:

Lindy K. Lee

LINDY K. LEE
District Division Chief - NR Right of Way
Date: 2/1/10

APPROVAL
RECOMMENDED:

Clark A. Peri

CLARK A. PERI
Project Manager
Date: 1-14-10

APPROVED BY:

Jody Jones

JODY JONES
District Director, District 3
Date: 2/1/10

REPORT SIGNATURE SHEET



This Project Scope Summary Report has been prepared under the direction of the following registered civil engineer. The registered civil engineer attests to the technical information contained herein and the engineering data upon which recommendations, conclusions, and decisions are based.

Molly Richard

Molly Richard
Registered Civil Engineer

1-18-10
Date



**PROJECT SCOPE SUMMARY REPORT FOR
SOUTH FORK AMERICAN RIVER BRIDGE
(PERFORM SEISMIC RETROFIT AND BRIDGE RAIL UPGRADE)**

The project will perform seismic retrofit and upgrade the bridge rail on the South Fork American River Bridge. This Project Scope Summary Report (PSSR) is being prepared to identify scope, cost and schedule for programming the project.

Capital Costs: \$ 2,187,000

Structures: \$ 640,000

Roadway: \$ 1,062,000

Right of Way: \$ 485,000

Funding Source: 2010 SHOPP

Type of Facility: Route 49 is a two-lane conventional highway.

Project Program: 20.XX.201.113
Bridge Seismic

Anticipated Environmental Clearance Document: Negative Declaration/
Categorical Exclusion

Construction Year: 2013/14

PM Limits: 03-ED-49 PM 23.99

Description: About 8.5 miles north of Placerville at South Fork American River Bridge (Br. No. 25-0021)

Seismic Retrofit and
Bridge Rail Upgrade.

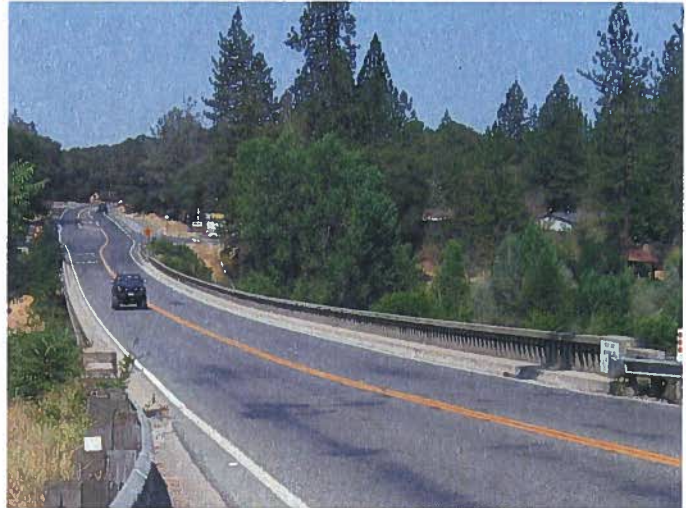

Existing bridge railing on South Fork American River Bridge.



Underside of bridge deck, showing existing bracing of steel beams and connections to concrete piers.

* For Escalated Cost breakdown including support, see Programming Sheet, *Attachment J*.

1. Introduction

This project proposes to perform seismic retrofit and bridge rail upgrade on the South Fork American River Bridge on State Route (SR) 49 in El Dorado County near Coloma. The Bridge Seismic Restoration program is a legislatively mandated program and this Project Scope Study Report (PSSR) is being prepared to program, fund and schedule the project.

2. Recommendation

Recommend that the project be approved and proceed into the design phase.

3. Location and Problem

The Bridge Inspection Reports for these structures indicate that seismic retrofit work is needed. The work will ensure that the structure performs adequately in a seismic event. See Table 1 for project location and description.

Table 1 – Project Location and Description

Structure Name	Bridge Number	Post Mile	Description
South Fork American River Bridge	25-0021	23.99	<ul style="list-style-type: none"> • Vulnerable hinges • Tall steel girders need cross bracing • Bridge rail does not meet current standards

4. Project Proposal

The work proposed is summarized in Table 2 below. The capital cost for this proposal is \$2,187,000. A second alternative to widen the structure to accommodate standard shoulders and sidewalk was considered but rejected by Project Development Team consensus due to significant structures cost. See the Structures Advance Planning Study (APS), *Attachment C*, for more details.

Table 2 – Proposed Work

Structure Name	Proposed Work
South Fork American River Bridge	<ul style="list-style-type: none"> • Strengthen cross frames • Add transverse keeper plates to upper flange • Replace existing barrier with Type 732 with tubular bicycle rail • Remove existing AC surfacing on bridge deck • Remove and replace unsound concrete • Place 3/4" polyester concrete overlay • Replace Metal Beam Guardrail approaches • Construct approach and departure pavement conform tapers

During the project Approval and Environmental Document phase, the type of barrier rail to be placed on the structure must be verified with Landscape architecture. Due to time constraints, this report was prepared assuming a Type 732 barrier rail. Additional funds are included in the roadway estimate in the event that a more costly type of rail (such as Type 80) is ultimately selected.

5. Cost Estimates

See the Cost Estimate Summary, *Attachment I*, for detailed cost information.

6. Project Factors

Right of Way

All work will be performed within the existing right of way. Construction may need to remove and replace an existing gate on state right of way in order to accommodate equipment. The gate is there via encroachment permit. An existing 6-inch district irrigation water pipe is hanging from the underside of the bridge deck. The pipe does not need to be relocated and will be protected in place during construction. See the Right of Way Data Sheet, *Attachment D*, for more information.

Environmental Status and Issues

In order to identify environmental issues, constraints, costs and resource needs, the Environmental Management Branch has prepared a Preliminary Environmental Analysis Report (PEAR) for the project (see *Attachment E*). Based on current information, it is anticipated that an environmental study must be completed to determine the appropriate environmental documentation for this project. This documentation is expected to be a Negative Declaration pursuant to the California Environmental Quality Act (CEQA) and a Categorical Exclusion pursuant to the National Environmental Policy Act (NEPA). If the area below the South Fork American River Bridge is not used for staging and construction access, then it is anticipated that the environmental document will be a Categorical Exemption (CEQA) and a Categorical Exclusion (NEPA) with no permits.

Potential impacts which require further studies include Biological Resources, Hazardous Waste, Water Quality, Landscape/Visual Impacts and Cultural Resources.

Community Impacts

A Community Impact Assessment (CIA) may be required to include an economic impact analysis. This analysis must address the potential for temporary access restrictions to local businesses during construction. The proposed project will not impact property values, neighborhood cohesion, community facilities, character and stability of the community, nor will it be inconsistent with the General Plan.

Visual/Aesthetics

A Visual Impact Assessment (VIA) was prepared for this project to identify potential issues. In order to reduce the visual impact of the project, all exposed ground surfaces should be seeded with appropriate species, invasive non-native species should be abated and all areas used for staging, access or other activities should be contour graded.

The decision for the type of rail replacement should be under the guidance of the Landscape Architecture Division. Due to the fact that this stretch of highway is eligible for the California

Scenic Highway System designation, aesthetics need to be considered in selection of materials and color.

Cultural Resources

This area has been previously surveyed by Far Western Anthropological Research Group, Inc., and no cultural resources were identified. However, a field review conducted by the archaeologist revealed exploratory trenches for gold mining in the southwest corner of the project area and disturbed mine tailings within the riverbed. In addition, three historic and one prehistoric/historic archaeological site, one historic district, and a Native American village (Koloma) were identified within a half-mile of the project area.

Water Quality and Storm Water Runoff

No permanent water quality impacts are expected as a result of this project. Construction Site Best Management Practices (BMPs) shall be selected to protect water bodies within or near the project limits from potential water pollution runoff from construction activities. These BMPs will be identified in the contractor prepared Storm Water Pollution Prevention Plan (SWPPP) or as contract line items.

This project shall adhere to the conditions of the Caltrans Statewide National Pollutant Discharge Elimination System (NPDES) Permit.

Hazardous Waste

An Initial Site Assessment (ISA) was prepared for this project to identify potential hazardous waste issues (see *Attachment F*). There are three potential issues including aurally deposited lead, lead/chromium based paint (traffic stripe and on the structure), naturally occurring asbestos, and treated wood waste (metal beam guardrail posts). The project will need to include appropriate bid items and non-standard special provisions in relation to these items. See the ISA for more information.

Biological Environment

The project site will be reviewed to confirm specific habitat types and species within the environmental study limits.

Migratory bird species are known to occur in the vicinity of the project. Impacts to these species can be minimized by removing trees and/or vegetation outside of the bird nesting season. Exclusionary devices to prevent swallows from building nests should be installed prior to nesting season.

Traffic Management Plan

A Traffic Management Plan (TMP) Data Sheet was prepared for this project (see *Attachment G*). According to Caltrans 2007 data, traffic volumes at this location are 500 vehicles per hour during the peak hour, with an annual average daily total of 5,400 vehicles per day.

One minimum 11-foot lane with one 4-foot shoulder must remain open at all times. A temporary signal is proposed to provide one-way (reversible) traffic control for the duration of the project. Portable changeable message signs will be required during lane, shoulder or bridge closures.

Access must be maintained during construction for pedestrians, bicycles, driveways and cross streets.

Work at this location may require assistance of COZEEP, but probably not a full time presence.

K-rail must be secured in place prior to allowing traffic on the bridge when the bridge rail has been removed.

Roadway Geometrics

State Route 49 in the project vicinity is a two lane conventional highway with 12-foot lanes and a minimal (1-foot) shoulder. Table 3 summarizes the roadway as follows:

Table 3 – Roadway Geometrics

South Fork American River Bridge	Curve Radius	Through Traffic Lanes			Paved Shoulder Width		Median Width
		No. Lane	Lane Width	Type AC or PCC	Left	Right	
Existing Roadway	-	2	12	AC	N/A	1	N/A
Existing Bridge	-	2	12	PCC with AC overlay	N/A	1	N/A
Proposed Bridge	-	2	11	PCC with polyester concrete overlay	N/A	2.5	N/A

The latest collision rate for this section of SR 49 for the three-year period from September 1, 2005 to August 31, 2008 is listed in Table 4.

Table 4 – Collision History

County	Route	PM	DIR	TOT	FAT	INJ	F+I	Actual MVM			Average MVM		
								FAT	F+I	TOTAL	FAT	F+I	TOTAL
El Dorado	49	23.99	Both	1	0	0	0	0.000	0.00	1.70	0.042	0.85	1.67

Within the three-year period (2005 through 2008), there was only one collision in the vicinity of the project resulting in neither a fatality nor an injury. The accident rate shown in the above table calculates the rate using a very short length of highway (0.1 miles) which skews the million vehicle mile (MVM) accident rate higher. A traffic collision report was pulled using the same time frame spanning 0.6 miles, which resulted in 4 collisions (none fatality or injury) and a rate of 1.13 accidents per MVM. This project should have no impact on the collision rates since the current roadway shoulder widths will remain unchanged.

A Design Exception Fact Sheet was approved on August 25, 2009 to allow the existing 1-foot shoulders to remain in place.

7. Project Funding and Schedule

This project is proposed to be funded in the 2010 SHOPP through the 20.XX.201.113 Bridge Seismic Restoration program. See the project programming sheet, *Attachment J*, for details on the proposed project schedule.

8. Project Personnel

Title	Name
Design Engineer	Isam Tabshouri
Project Engineer	Molly Richard
Project Manager	Clark Peri
District Bridge Maintenance Engineer	David Lamb
Structures Liaison Engineer	Steve Wiman
Structures Project Engineer	Gregory Slocum
Right of Way Agent	Kelly Kilpatrick
Environmental Coordinator	Denise Gibson
Hazardous Waste	Alicia Beyer
Traffic Management Plan	Sudha Kodali
Landscape Architecture	Kathleen Grady

9. Project Reviews

District 3 Bridge Maintenance	David Lamb	October 2009
Structures Liaison	Steve Wiman	October 2009
HQ Program Advisor	Kevin Wall	October 2009

A District Safety Review was completed in September 2009. A formal Constructability Review has been deferred to the next phase, per discussions with Bari Khaliki, North Region Constructability Review Coordinator.

10. List of Attachments

- A. Location Map
- B. Layouts and Typical Sections
- C. Advance Planning Study
- D. Right of Way Data Sheet
- E. Preliminary Environmental Analysis Report
- F. Initial Site Assessment for Hazardous Waste
- G. Traffic Management Plan Data Sheet
- H. Landscape Architecture Assessment Sheet
- I. Cost Estimate Breakdown
- J. Programming Sheet

ATTACHMENT A

LOCATION MAP

Location Map

Seismic Retrofit - EA 03-0F310K

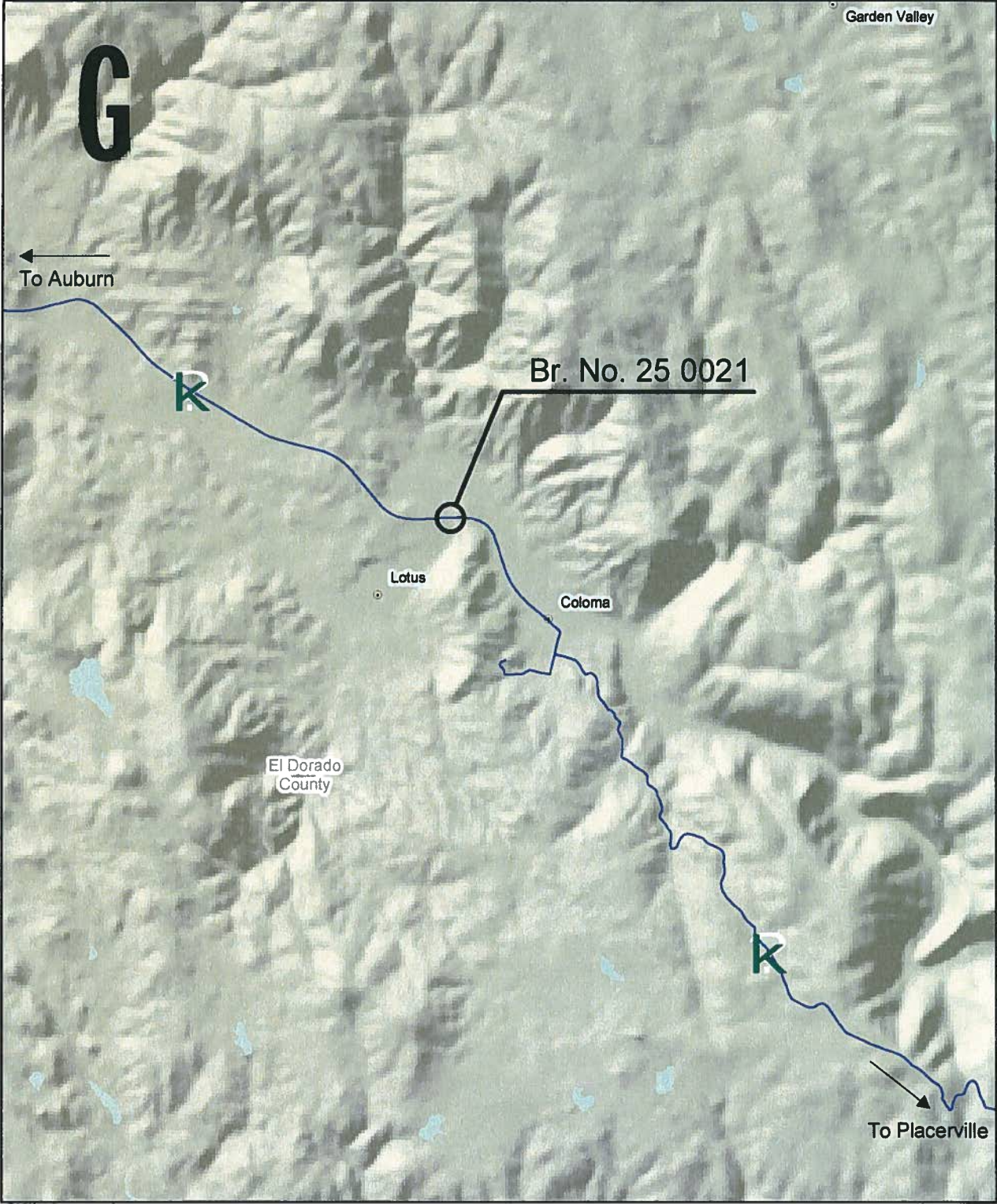

ATTACHMENT B

LAYOUTS AND TYPICAL SECTIONS

STATE OF CALIFORNIA - DEPARTMENT OF TRANSPORTATION
ADVANCE PLANNING
 FUNCTIONAL SUPERVISOR: CHAD BAKER
 DESIGNED BY: F. BAYTAM
 REVISIONS: DATE REVISION

03	Ed	49	24.0		
REGISTERED CIVIL ENGINEER DATE					
PLANS APPROVAL DATE					



NOTICE: FOR CORRECT RIGHT OF WAY AND ACCURATE ACCESS DATA, SEE RIGHT OF WAY RECORD MAPS AT DISTRICT OFFICE.

- LEADING
- AC TAPER
- CONSTRUCT TEMPORARY ACCESS ROAD
- TEMPORARY STAGING AREAS

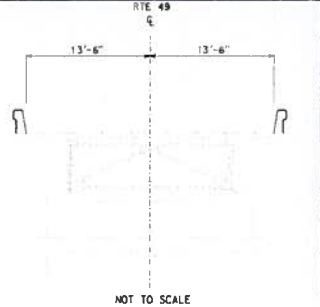

**LAYOUT
 ALTERNATIVE 1**
 SCALE: 1" = 50'

L-1

DATE PLOTTED: 08-17-09
 PLOT NUMBER: 11-0072.B.12

ATTACHMENT C

ADVANCE PLANNING STUDY

Memorandum

*Flex your power!
Be energy efficient!*

To: CHAD BAKER
PROJECT ENGINEER
DISTRICT 3

Date: March 10, 2009

File: 03-ED-49-23.99
03-0F310K
S F American River Br No 25-0021,
Retrofit, Widening

From: GUDMUND SETBERG
Bridge Design Branch 2
Office of Bridge Design North
Structure Design
Division of Engineering Services MS 9-4/8I



Subject: Advance Planning Study Transmittal

Attached are two copies of the Advance Planning Study for the above referenced project as submitted to the Division of Engineering Services by your Request Memo dated August 5, 2008.

The estimated construction cost, including 10% mobilization and 25% contingencies, is as follows:

<u>Structure Name</u>	<u>Bridge No.</u>	<u>Cost Estimate</u>	<u>Working Day Estimate</u>
S F American River Br Alt. #1	25-0021		
Rail Upgrade, Overlay & Seismic Retrofit		\$640,000	70
Seismic Retrofit only		\$82,000	
S F American River Br Alt. #2	25-0021		
Widening, Rail Upgrade, Overlay, Seismic Retrofit		\$6,893,000	250

This Advance Planning Study and associated cost estimate are based on the following assumptions:

Alternative #1

1. Scour not significant over remaining life of bridge
2. 1 Lane of traffic to remain open except for short periods
3. No trestle work required in river

Alternative #2

1. Scour not significant over remaining life of bridge
2. 1 Lane of traffic to remain open except for short periods
3. Access trestles required to Piers 5 and 6
4. 10 tons/sf allowable soil bearing pressure
5. Existing footing elevations per As-Built plans

The estimated working days are considered to be at a preliminary level of accuracy and without regard to specific information related to construction staging, closure pours, settlement periods, procurement of material, existing or future utilities, permits, traffic information, environmental constraints, specific seasonal work, etc.

CHAD BAKER - District 3
March 9, 2009
Page 2

If you have any questions or if you need additional information regarding this study, please contact Gregory Slocum at 916-227-8475 or Gudmund Setberg at 916-227-8282

Attachments

- c: JAN RUTENBERGS, Project Coordination Engineer MS 9-5/11G
- GUDMUND SETBERG, Bridge Design Office Chief MS 9-4/8I
- STEVE WIMAN, Technical Liaison Engineer MS 9-1/5C FM2
- PETE WHITFIELD, Structure Maintenance & Investigations MS 9-1/9I
- KEVIN WALL, HA21 Program Coordinator MS 9-1/9I
- STEVE ALTMAN, Structure Const Assist Deputy Division Chief MS 9-2/11H
- ROY BIBBENS, Geotechnical Services MS 5
- STEVE NG, Structure Hydraulics & Hydrology (if applicable) MS 9-1/2I

DIST.	COUNTY	ROUTE	POST MILE
03	EO	49	23.99

To get to the letters on site, go to: <http://www.dot.ca.gov>

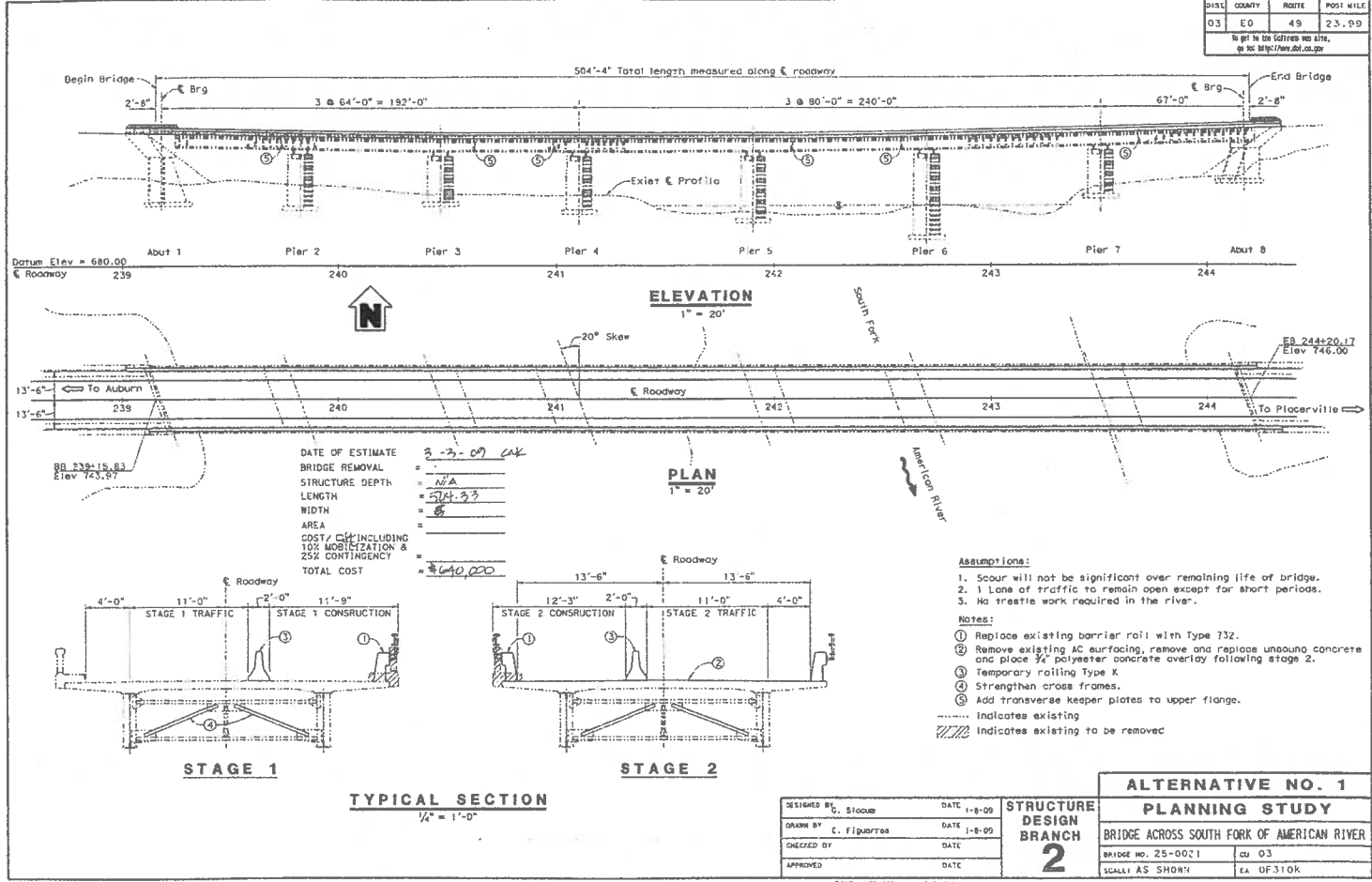

DIST.	COUNTY	ROUTE	POST MILE
03	ED	49	23.99

to get the latest and best, go to: <http://www.dot.ca.gov>

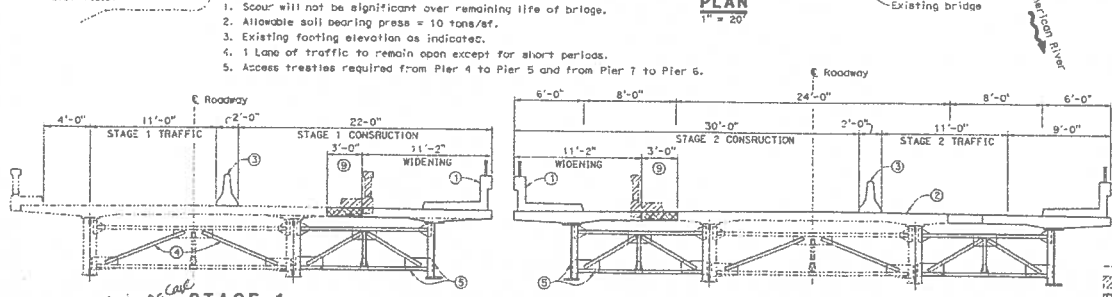
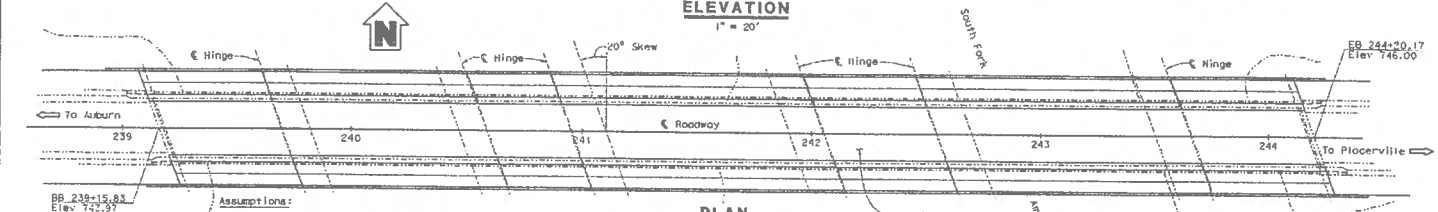
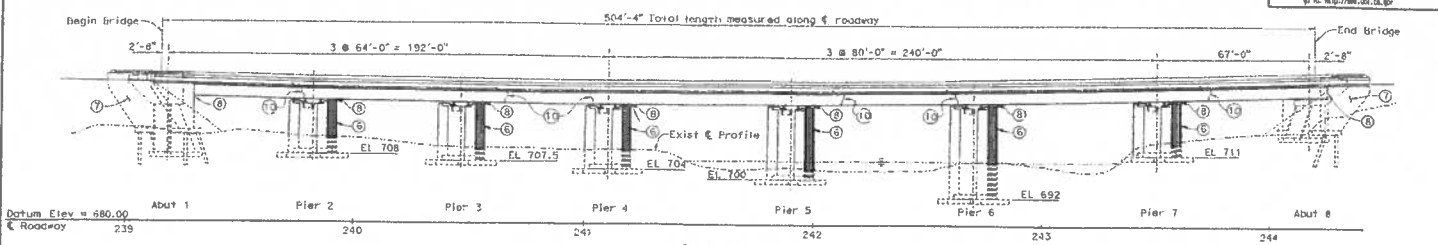

- Notes:**
- Replace existing barrier rail with Type 26
 - Remove existing AC surfacing, remove and replace unbound concrete and place 3/4" polyester concrete overlay following stage 2.
 - Temporary rolling Type K.
 - Strengthen cross frames.
 - New plate girders and cross frames.
 - Extend piers on new spread footings.
 - Extend abutments on new pile footings.
 - Replace existing rocker bearings with concrete blocks and elastomeric bearings, new girder on elastomeric bearing.
 - Closure pour
 - Add transverse keeper plates to upper flange.
- Indicates existing
 Indicates existing to be removed
 Indicates remove and replace

DATE OF ESTIMATE: 3-10-09
 BRIDGE REMOVAL: case
 STRUCTURE DEPTH: 11'-0"
 LENGTH: 504'-4"
 WIDTH: 34'-0"
 AREA: 17,352 sq ft
 COST / C/YE INCLUDING 10% INFLATION & 2% CONTINGENCY: \$ 612,000
 TOTAL COST: \$ 6,120,000

TYPICAL SECTION
 1/4" = 1'-0"

DESIGNED BY: J. Stocum	DATE: 1-8-09
DRAWN BY: C. Figueroa	DATE: 1-8-09
CHECKED BY:	DATE:
APPROVED:	DATE:

STRUCTURE DESIGN BRANCH
2

ALTERNATIVE NO. 2	
PLANNING STUDY	
BRIDGE ACROSS SOUTH FORK OF AMERICAN RIVER	
BRIDGE NO. 25-0021	CU 03
SCALE: AS SHOWN	LA DF 3102

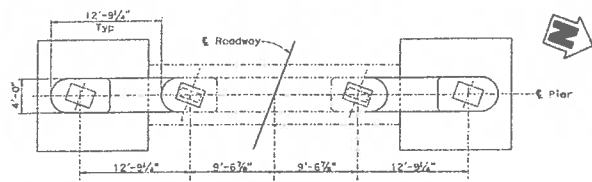

PIER PLAN
3/8" = 1'-0"

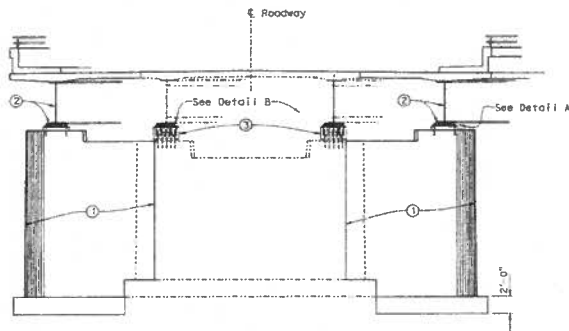

PIER ELEVATION
3/8" = 1'-0"

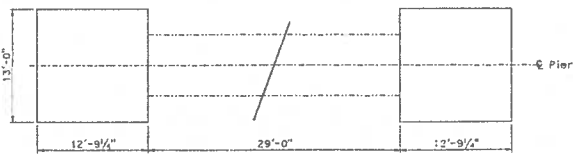

PIER FOOTING PLAN
3/8" = 1'-0"

Notes:

- ① Widen existing piers on new spread footings.
- ② Widen plate girders on new elastomeric bearings.
- ③ Replace existing rocker and pinned bearings with elastomeric bearings.
- ④ Detail and notes are typical to "Detail A", except as noted.

----- Indicates existing

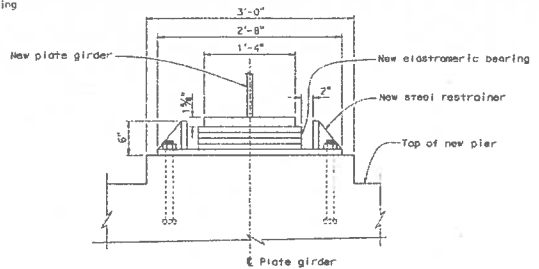

DETAIL A
1 1/2" = 1'-0"

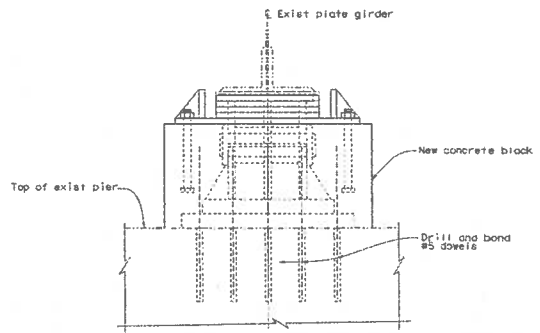

DETAIL B
1 1/2" = 1'-0"
See note ④

DIST	COUNTY	ROUTE	POST MILE
03	EO	49	23.99

In 911 in the District with Title, go to: 12345/789/012/345

JAN 09 2008

DESIGNED BY: G. Slocum	DATE: 1-8-08
DRAWN BY: C. Figueroa	DATE: 1-8-08
CHECKED BY:	DATE:
APPROVED:	DATE:

STRUCTURE DESIGN BRANCH
2

ALTERNATIVE NO. 2	
PIER DETAILS	
PLANNING STUDY	
BRIDGE ACROSS SOUTH FORK OF AMERICAN RIVER	
BRIDGE NO. 25-0021	CU 03
SCALE AS SHOWN	EA. OF 310K

11-0072.B.18

DIST.	COUNTY	ROUTE	POST MILE
03	ED	49	23.99

Is per the contract with
 No. 25-0021
 No. 25-0021

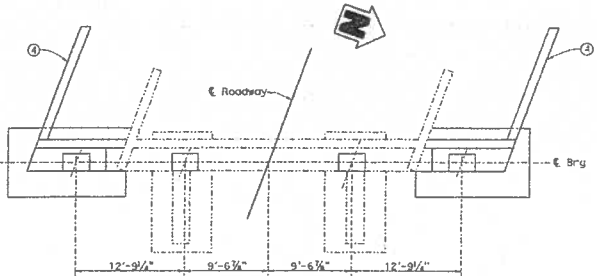

PLAN
 3/8" = 1'-0"

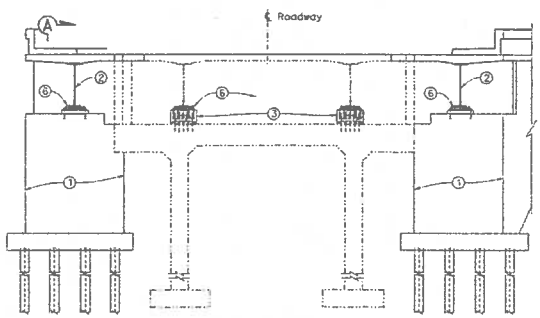

ELEVATION
 3/8" = 1'-0"

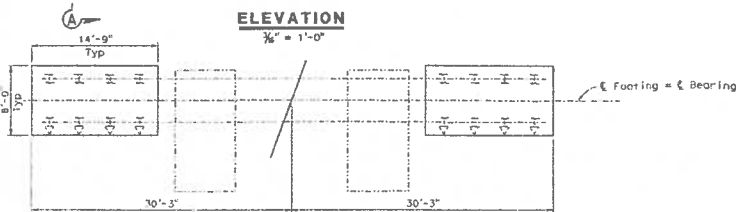

ABUTMENT 1 PILE LAYOUT
 3/8" = 1'-0"
 See note 5

- Notes:
- Widen existing abutments on new pile footings.
 - Widening plate girders on new elastomeric bearings.
 - Replace existing rocker and pinned bearings with elastomeric bearings on concrete blocks.
 - New wingwalls.
 - Abutment 1 shown, Abutment 8 similar.
 - For detail, see "Detail A and Detail B" on "Pier Details" sheet.
- Indicates existing

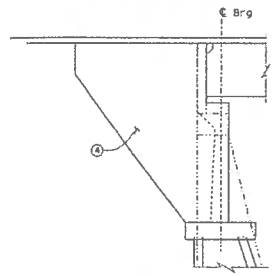

WINGWALL ELEVATION
 3/8" = 1'-0"
 See note 5

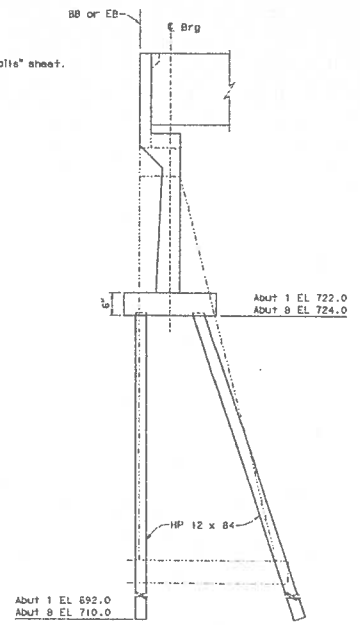

SECTION A-A
 1/4" = 1'-0"
 See note 5

ALTERNATIVE NO. 2	
ABUTMENT DETAILS	
PLANNING STUDY	
BRIDGE ACROSS SOUTH FORK OF AMERICAN RIVER	
BRIDGE NO. 25-0021	CU 03
SCALE: AS SHOWN	1A OF 310A

DESIGNED BY G. Stocum	DATE 1-8-09
DRAWN BY C. Figueroa	DATE 1-8-09
CHECKED BY	DATE
APPROVED	DATE

STRUCTURE DESIGN BRANCH
2

STRUCTURE DESIGN BRANCH PLANNING STUDY SHEET (SCALE) SHEET 1A OF 310A

FILE # 75-0021 CON. 0120401.dgn

THE ADP/ID # 0912
 05/06/09 10:51:30 AM EST ELCITD * 05/06/09

ATTACHMENT D

RIGHT OF WAY DATA SHEET

Memorandum

To: ISAM TABSHOURI
Senior Transportation Engineer
Department of Transportation, District 3

Attention MOLLY RICHARD
Project Engineer

Date: January 8, 2010

File: 03-ED-49/PM-23.99
E.A. 0F310K
Alternate No. N/A

From: BRENT GREEN 
North Region Right of Way Manager
Marysville

Seismic retrofit and rail upgrade
of South Fork American River
Bridge (Br. No. 25 0021)

Subject: Current Estimated Right of Way Costs

We have completed an estimate of the right of way costs for the above referenced project based on information received from you on November 9, 2009 .

Right of Way Lead Time will require a minimum of **3** months prior to the scheduled certification date in order to complete the certification, assuming phase 9 mitigation expenditure requirements are not needed prior to Right of Way Project Certification.

Attachments:

Right of Way Data Sheet
Resource Hrs. Request

cc. CLARK PERI

STATE OF CALIFORNIA - DEPARTMENT OF TRANSPORTATION
RIGHT OF WAY DATA SHEET

REVISED



Date: January 8, 2010

03-ED-49/PM-23.99
 E.A. 0F310K
 Seismic retrofit and rail upgrade of South
 Fork American River Bridge (Br. No. 25
 0021)

1. Right of Way Cost Estimate:

	Current Value Future Use	Escalation Rate	Escalated Value
A. Total Acquisition Cost	\$0		\$0
B. Mitigation acquisition & credits	\$391,500	5%	\$471,628
C. Project Development Permit Fees	\$11,382	5%	\$13,712
Subtotal	\$402,882		\$485,339
D. Utility Relocation (State Share) (Owner's share: \$0)	\$0		\$0
E. Relocation Assistance (RAP)	\$0		\$0
F. Clearance/Demolition	\$0		\$0
G. Title & Escrow	\$0		\$0
H. Total Estimated Right of Way Cost	\$402,882	Rounded	\$485,000
I. Construction Contract Work	\$0		

2. Current Date of Right of Way Certification

November 1, 2013

3. Parcel Data:

Type	Dual/Apr	Utilities	RR Involvements
X	0	U4 - 1 0	None x
A	0	- 2 0	C&M Agrmt
B	0	- 3 0	Svc Contract
C	0	- 4 0	Easements
D	0	U5 - 7 0	Rights of Entry
		- 8 0	Clauses
Total	0	- 9 0	
Areas:			Misc. R/W Work
R/W:	N/A		RAP Displ N/A
Excess:	N/A	No. Excess Pcls: 0	Clear/Demo N/A
Mitigation:	N/A		Const Permits N/A
			Condemnation N/A
			USA Involvement 0

STATE OF CALIFORNIA - DEPARTMENT OF TRANSPORTATION
RIGHT OF WAY DATA SHEET

4. Are there any major items of construction contract work?
Yes _____ No X
5. Provide a general description of the right of way and excess lands required (zoning, use, major improvements, critical or sensitive parcels, etc.).

No right of way required.
6. Are any properties acquired for this project expected to be rented, leased, or sold?
Yes _____ No X
7. Is there an effect on assessed valuation? Yes _____ Not Significant _____
No X
8. Are utility facilities or rights of way affected? Yes _____ No X

According to P.E. Molly Richard and Structures the irrigation pipe that runs underneath the Bridge does not need to be moved. If at some point during construction the pipe needs to be relocated then another Data Sheet will have to be provided showing the revision. This project is exempt from Positive location according to section 4-4 of the High-Low risk policy.

9. Are railroad facilities or rights of way affected? Yes _____ No X
10. Were any previously unidentified sites with hazardous waste and/or material found?
Yes _____ None Evident X
11. Are RAP displacements required? Yes _____ No X
- | | | | |
|----------------------|-------------------|---------------------------|-------------------|
| No. of single family | <u> </u> | No. of business/nonprofit | <u> </u> |
| No. of multi-family | <u> </u> | No. of farms | <u> </u> |

Based on Draft/Final Relocation Impact Statement/Study dated N/A
it is anticipated that sufficient replacement housing (will/will not) be available without Last Resort Housing.

12. Are there material borrow and/or disposal sites required?
Yes _____ No X
13. Are there potential relinquishments and/or abandonments?
Yes _____ No X
14. Are there any existing and/or potential airspace sites?
Yes _____ No X
15. Indicate the anticipated Right of Way schedule and lead time requirements. (Discuss if district proposes less than PMCS lead time and/or if significant pressures for project advancement are anticipated.)

Right of Way Lead Time will require a minimum of 3 months after we receive first appraisal maps, utility conflict maps, and the necessary environmental clearance and freeway agreements have been approved and obtained. Additionally a minimum of 3 months will be required after receiving the last appraisal map to Right of Way for certification.
16. Is it anticipated that Caltrans will perform all Right of Way work?
Yes X No _____
17. Clearance of improvements will be required; contractor may need to remove and replace an existing gate on the state right of way. The gate is there via an encroachment permit. TCE's are not anticipated for this project. The project will have a construction staging area (2.45 acres) within the existing state right of way.

STATE OF CALIFORNIA - DEPARTMENT OF TRANSPORTATION
RIGHT OF WAY DATA SHEET

18. Environmental Mitigation is anticipated on this project at the cost of 391,500. The 3 month lead time is sufficient as long as mitigation is not required prior to certification. If mitigation is required prior to certification, the schedule and resources would need to be adjusted. Fish and Game 1602 Permit at a cost of \$4,000 and 401 Water Quality Certification Permit \$7,382 as documented in the PEAR Report are required for this project.
19. No other Right of Way activities are involved with this project, and that the disposal site will be handled by const

Evaluation Prepared By:

Right of Way:

KIMBERLY RUDOLPH

Date 12/31/09

Reviewed By:

RW Planning & Management:



RICH COVEY

Date 1/6/10

I have personally reviewed this Right of Way Data Sheet and all supporting information. I certify that the probable Highest and Best Use, estimated values, escalation rates, and assumptions are reasonable and proper, subject to the limiting conditions set forth, and I find this Data Sheet to be complete and current.

JEFFERY A. PURDIE,
Senior Right of Way Agent
Estimating
Marysville

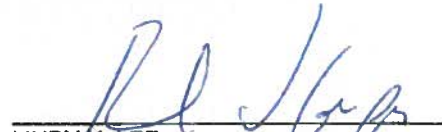
1/6/2010
Date

LINDY K. LEE,
North Region Right of Way Manager
Marysville

1/6/2010
Date

ATTACHMENT E

PRELIMINARY ENVIRONMENTAL ANALYSIS REPORT (PEAR)



PRELIMINARY ENVIRONMENTAL ANALYSIS REPORT

1. Project Information

District 3	County ED	Route 49	PM 23.99	EA 03-0F310K
Project Title: Seismic Retrofit and Bridge Railing Replacement of the South Fork American River Bridge (Br # 25-0021, PM 23.99)				
Project Manager Clark Peri			Phone # (916) 274-0538	
Project Engineer Molly Richard			Phone # (530) 741-5746	
Environmental Office Chief/Manager Kendall Schinke			Phone # (530) 741-4591	
PEAR Preparer Denise Gibson			Phone # (530) 741-4570	

2. Project Description

Purpose and Need

The purpose and need for this project is to improve the safety standards of this state highway bridge. The current Structure Replacement and Improvement Needs Report (STRAIN) report for the South Fork of the American River Bridge (Br # 25-0021) indicated the need for improvement. The bridge and the railing will need to be upgraded for seismic safety standards.

Description of work

The project is located in El Dorado County on Highway 49 at the South Fork American River Bridge (Bridge No. 25-0021) near the town of Lotus.

The proposed bridge railing upgrade, deck rehabilitation and seismic retrofit of the South Fork American River Bridge will involve the following structure construction activities. For traffic management, construction will take place in two phases. Each phase will be designed to complete construction on one side of the bridge, which will allow one lane to remain open for traffic on the opposite side of the bridge deck. Traffic control will be needed during construction.

Barrier Railing Replacement:

This work will consist of removal of the existing barrier railing and a portion of the deck overhang, reconstruction of the concrete deck overhang, and construction of a new

Concrete Barrier Type 732. To remove and reconstruct the railing, the following work will take place:

- Temporary Railing Type K will be placed on the bridge to provide a work area slightly narrower than half the bridge width. Traffic will be reduced to one lane.
- The contractor will construct formwork and a protective cover below the existing deck overhang. This will be supported from the existing bridge girders.
- The contractor will access the area alongside and below the bridge west of the river from an existing gravel road located at the southwest quadrant of the bridge to the right of Abutment 1. Some minor grading and brush trimming will be needed to improve access to the bridge.
- Manlifts will be used to install the formwork from below the bridge, except in areas over the active river that can not be reached from the bank. Formwork in the area over the river will be installed from the bridge deck using an underbridge access truck.
- Areas at the east end of the bridge in span 7 could be accessed from an existing path at the northeast quadrant to the left of Abutment 8. The path could be improved with minor grading to accommodate small equipment such as a manlift.
- The existing barrier and portion of the deck overhang will be removed by saw cutting and demolition with jack hammers and a backhoe-mounted jack hammer.
- The deck will be formed, reinforcing bars placed and spliced to existing reinforcement, and concrete will be placed.
- The barrier will then be formed, reinforcing bars placed and concrete placed.
- Barrier forms will be removed and the barrier surface will be finished.
- Formwork and protective cover will be removed.
- These activities will be repeated in stage 2 to complete the other half of the bridge.

Deck Rehabilitation

- Existing AC surfacing on the bridge deck will be removed by grinding.
- The deck joints will be cleaned of debris.
- Areas of unsound concrete will be removed from the deck using small jack hammers. New concrete will be placed to fill the holes.
- Deck surface will be cleaned using shot blasting equipment.
- Deck will be treated with methacrylate resin and a 0.75 inch polyester concrete overlay will be placed using paving equipment.
- These activities will be repeated in stage 2 to complete the other half of the bridge.
- The contractor will control the operation so material does not enter the river.

Seismic Retrofit

- The existing cross bracing located between the steel girders near the abutments and piers will be strengthened by adding additional steel bracing members. These will be either bolted or welded into place.
- Steel plates will be added to the top flange of the girders at the hinge locations to restrict lateral movement. These will be welded into place.

- Paint will be removed by blasting in areas to be welded. All debris will be contained. After welding, bare metal areas will be painted.
- Access for this work will be from below the bridge except at the hinges in span 5 over the water which will be accessed from the bridge deck.

Additional Work:

- Remove and replace approach metal beam guard rails on both sides of the bridge.
- AC conform – grind and overlay will be completed approximately 100 feet from both sides of the bridge deck. The thickness layer will vary from 1 inch to 3.25 inches.

Proposed Staging Areas:

- Two staging areas have been identified: one on the southwest side of the bridge, south of piers 2, 3, & 4; the second at the southwest corner of Highway 49 and Lotus Road. No permanent right of way will be needed for these areas.

A Traffic Management Plan will be developed to accommodate traffic flow through this project area during construction. It is currently proposed to construct the project in two stages in order to avoid the need for a road closure during construction. Traffic control will include temporary, one way reversing traffic signal, temporary k-railing, with temporary crash cushion per 2006 Standard Plan T13.

The project will have State and Federal funds.

3. Anticipated Environmental Approval

CEQA		NEPA	
Environmental Determination			
Statutory Exemption	<input type="checkbox"/>		
Categorical Exemption	<input type="checkbox"/>	Categorical Exclusion	<input checked="" type="checkbox"/>
Environmental Document			
Initial Study or Focused Initial Study with Negative Declaration or Mitigated ND	<input checked="" type="checkbox"/>	Environmental Assessment with Finding of No Significant Impact	<input type="checkbox"/>
Environmental Impact Report	<input type="checkbox"/>	Environmental Impact Statement	<input type="checkbox"/>
CEQA Lead Agency (if determined):		Caltrans	
Estimated length of time (months) to obtain environmental approval:		24	
Estimated person hours to complete identified tasks:		4,765	

4. Special Environmental Considerations

The following measures would be necessary to avoid impacts to the environment during construction: Exclusionary netting and devices may be installed on the bridge to prevent

use of the bridge by nesting swallows and roosting bats. Netting and devices would need to be installed between September 1 and February 14. The approximate cost of exclusionary netting and devices for swallows and bats, based on similar type work at other past projects, is estimated at \$50,000.

Further studies are required to determine whether the bridge is used by bat species during the winter months. If the bridge is used by bats during the winter, then exclusionary devices would still be needed for bats, and the devices would need to be placed prior to bats returning to winter in the bridge. The project site will be surveyed for specific habitat types and species within the Environmental Study Limits (ESL). Flora and fauna field surveys will also be completed by a qualified Caltrans Biologist prior to the completion of the environmental document. Three to six months will be needed to complete floristic and wildlife surveys. Floristic surveys are done during the spring, summer, and autumn months and wildlife surveys can be done at various times during the year according to protocol for individual species.

If the area below the bridge and within the bed and bank of the South Fork American River is to be utilized for staging and construction access. The work will require temporary construction access on the banks of the river. A United States Army Corps of Engineers (USACE), Section 404, Nationwide Permit 33 will be required. In addition, based on the given 2.45 acres of disturbed soil, a Water Quality Control Board (WQCB) Section 401 Water Quality Certification will be required with a cost of \$7,382. A Department of Fish and Game (DFG) 1602 permit will also be required with a cost of \$4,000.

The work over the South Fork of the American River will be fully contained and no debris will be allowed to enter the waterway.

A special provision shall be added to the contract to address National Emission Standard Hazardous Air Pollutants (NESHAP) notification.

The required Lead Compliance Plan covering ADL, Yellow traffic striping, and the Structure Zinc Chromate Lead based paint is \$3,000.00.

The required for Asbestos Compliance Plan (ACP) and Dust Control Plan (DCP) is \$3,500.00.

5. Anticipated Environmental Commitments

Landscape - Consideration will need to be given to the aesthetics of the rail replacement and under the guidance of the Landscape Architecture Division. Erosion control and slope protection will be completed immediately after construction.

Hazardous Waste – A Lead Compliance Plan and appropriate standard specifications shall address Aerial Deposited Lead (ADL) for soil, zinc chromate lead based paint on the bridge structure and lead based paint from the thermoplastic highway striping paint. In addition, the appropriate standard specification for Naturally Occurring Asbestos

(NOA) will be utilized in the Plans, Specifications and Estimates (PS&E) for this project. Treated Wood Waste (TWW) may be contained in the posts for the metal beam guard railing (MBGR). The Department of Toxic Substances Control (DTSC) requires that TWW be disposed as a hazardous waste. In addition, the contractor shall prepare a detailed Health, Safety and Work Plan for all site personnel in accordance with the DTSC and CAL-OSHA regulations.

A special provision shall be added to the contract to address National Emission Standard Hazardous Air Pollutants (NESHAP) notification.

Biological - The biological surveys will need to be conducted during the appropriate seasonal blooming period and nesting/roosting seasons. The project site will be surveyed for specific habitat types and species within the ESL. Flora and fauna field surveys will also be completed by a qualified Caltrans Biologist prior to the completion of the environmental document. Three to six months will be needed to complete floristic and wildlife surveys. Floristic surveys are done during the spring, summer, and autumn months and wildlife surveys can be done at various times during the year according to protocol for individual species.

The work over the South Fork of the American River will be fully contained and no debris will be allowed to enter the waterway. The work will require temporary construction access on the banks of the river. A United States Army Corps of Engineers (USACE), Section 404, Nationwide Permit 33 will be required. In addition, a Water Quality Control Board (WQCB) Section 401 Water Quality Certification will be required with a cost of \$7,382.

6. Permits and Approvals

If the area below the bridge and within the bed and bank of the South Fork American River is to be utilized for staging and construction access. A Department of Fish and Game (DFG) 1602 permit will be required with a cost of \$4,000.

The work over the South Fork of the American River will be fully contained and no debris will be allowed to enter the waterway. The work will require temporary construction access on the banks of the river. A United States Army Corps of Engineers (USACE), Section 404, Nationwide Permit 33 will be required. In addition, based on the given 2.45 acres of disturbed soil, a Water Quality Control Board (WQCB) Section 401 Water Quality Certification will be required with a cost of \$7,382.

7. Level of Effort: Risks and Assumptions

Cliff Swallows were observed nesting under the South Fork American River Bridge. Migratory bird species are protected by the federal Migratory Bird Treaty Act (MBTA) of 1918. To minimize risk to nesting birds within the ESL during construction, vegetation/tree removal should be conducted outside of the bird nesting season. To prevent swallows from building nests on the South Fork American River Bridge, exclusionary devices should be implemented before the nesting season preceding

construction. If vegetation is not removed prior to construction, further preconstruction nest surveys for migratory birds will be required. If an active nest is found during construction, coordination with the California Department of Fish and Game will be required to determine an appropriate course of action.

There is a potential for the federal and state protected raptors and nesting birds to inhabit trees and structures within the ESL. A qualified biologist must conduct surveys and determine potential impacts to these species.

Field surveys will be completed by a qualified Caltrans biologist prior to the completion of the environmental document. Plant surveys will be scheduled during known blooming periods. Surveys to determine the presence of nesting birds and bats should be conducted during the nesting season (February 15 through August 31).

8. PEAR Technical Summaries

- 8.1 Land Use: The proposed project is not expected to have any impacts on land use.
- 8.2 Growth: The proposed project is not expected to have any impacts on growth.
- 8.3 Farmlands/Timberlands: The proposed project is not expected to have any farmland or timberlands impacts.
- 8.4 Community Impacts: A Community Impact Assessment (CIA) may be required to include an economic impact analysis. This analysis must address the potential for temporary access restrictions to the local businesses during construction. The proposed project will not impact property values, neighborhood cohesion, community facilities, character and stability of the community, nor will it be inconsistent with the local General Plan. All local emergency public service departments should be notified of the potential delays during construction once the project scope and construction schedule are more clearly defined.
- 8.5 Visual/Aesthetics: The primary visual impacts from this project are related to construction activities and ground disturbance from staging areas. Negative impacts to visual quality from construction activities will be short term, minor and temporary, if the following recommendations are adhered to:
 - Avoid removing trees when possible.
 - At the end of construction, all areas used for staging, access or other construction activities shall be contour graded which visually integrates the surrounding topography. All exposed ground surfaces should be seeded with appropriate species at all these areas, as early as possible for erosion control purposes. Plant species, native to the area, shall be used when re-vegetation is being completed.
 - Consideration will need to be given to the aesthetics of the rail replacement and under the guidance of the Landscape Architecture Division.
- 8.6 Cultural Resources: A record search of the California Historical Resources Information System was not conducted for this PEAR, but will be undertaken

during the environmental studies preceding environmental approval of the project. The area has been previously surveyed by Far Western Anthropological research Group, Inc. (FWARG) and no cultural resources were identified; however, a field review conducted by the archaeologist, Erick Wulf, revealed exploratory trenches for gold mining in the southwest corner of the project area and disturbed mine tailings within the riverbed. In addition, three historic and one prehistoric/historic archaeological site, one historic district, and a Native American village (Koloma) were identified within a half-mile of the project area. The South Fork American River Bridge was built in 1951 and is classified as a Category 5 bridge in the 2006 Statewide Historic Bridge Inventory.

- 8.7 Hydrology and Floodplain: A Floodplain Study for this bridge was prepared on November 4, 2008. No significant impacts or increases in floodwater elevations are expected based on the current scope of work.
- 8.8 Water Quality and Storm Water Runoff: This proposed project is expected to have a ground disturbance area greater than one acre, which will require the contractor to submit an approved Storm Water Pollution Prevention Plan (SWPPP). This plan must meet the standards and objectives to minimize water pollution impacts in accordance with Caltrans Standard Special Provision, Section 07-345 which shall be included in the Plans, Specification and Estimates (PS&E) to address these temporary construction water pollution control measures.
- 8.9 Geology, Soils, Seismic and Topography: The project is not expected to have any impacts on geology, soils, seismic or topography.
- 8.10 Paleontology: The proposed project is not expected to have any impacts on paleontology resources.
- 8.11 Hazardous Waste/Materials: Based on this review, potential hazardous waste/material issues have been identified for the proposed project. They are Aerial Deposited Lead (ADL), asbestos containing construction material, NOA and lead based paint. A Lead Compliance Plan shall address ADL in the soil adjacent to the highway, zinc chromate lead based paint on the bridge structure and lead based paint from the thermoplastic highway striping paint.

The Department of Toxic Substances Control (DTSC) requires that TWW be disposed as a hazardous waste. In addition, the contractor shall prepare a detailed Health, Safety and Work Plan for all site personnel in accordance with the DTSC and CAL-OSHA regulations regarding the handling of TWW.

A special provision shall be added to the contract to address National Emission Standard Hazardous Air Pollutants (NESHAP) notification.

For the preliminary estimate of cost purposes which need to be included in the BEES:

- The required Lead Compliance Plan covering ADL, Yellow traffic striping, and the Structure Zinc Chromate Lead based paint is \$3,000.00.
 - The required for Asbestos Compliance Plan (ACP) and Dust Control Plan (DCP) is \$3,500.00.
- 8.12 Air Quality: This safety project is exempt from air quality conformity analysis. Best Management Practices (BMP's) for air quality must be implemented during construction.
- 8.13 Noise and Vibration: The project does not meet the definition of a Type I project as defined by Caltrans' Traffic Noise Analysis Protocol; therefore, no noise analysis will be needed. Best Management Practices (BMP's) for noise reduction must be implemented during night and daytime construction.
- 8.14 Energy and Climate Change: The proposed project is not expected to have any impacts on Energy or Climate Change. The project will result in a low or no potential impact for climate change; consequently, the environmental document will include a qualitative discussion regarding climate change.
- 8.15 Cumulative Impacts: The proposed project is not expected to contribute to Cumulative Impacts.
- 8.16 Context Sensitive Solutions: Context Sensitive Solutions will be addressed in the Visual Impact Analysis and Design, primarily regarding the bridge rail design.
- 8.17 Biological Environment: The project site will be surveyed for specific habitat types and species within the ESL. Flora and fauna field surveys will also be completed by a qualified Caltrans biologist prior to the completion of the environmental document. Three to six months will be needed to complete floristic and wildlife surveys. Floristic surveys are done during the spring, summer, and autumn months and wildlife surveys can be done at various times during the year according to protocol for each individual species.

The South Fork American River Bridge (Br No 25-0021) provides suitable habitat for structure nesting/roosting species. Cliff swallows and bat species were observed nesting on/in the bridge. Under the current project scope, impacts to bats and migratory birds may result from project related activities, and avoidance measures will be required to avoid and minimize impacts to these species.

The following measures would be necessary to avoid impacts to these species: Exclusionary netting and devices may be installed on the bridge to prevent use of the bridge by nesting swallows and roosting bats, prior to construction. Netting and devices must be installed between September 1 and February 14. The approximate

cost of exclusionary netting and devices for swallows and bats, based on similar type work at other past projects, is estimated at \$50,000.

Exclusionary netting and devices for nesting swallows and roosting bats may not be necessary if project work were to occur between September 1 and February 14 (i.e. outside the nesting season). However, further studies are required to determine whether the bridge is used by bat species during the winter months. If the bridge is used by bats during the winter, then exclusionary devices would still be needed for bats, and the devices would need to be placed prior to bats returning to winter in the bridge.

The project engineer for this project estimated the soil disturbance will be 2.45 due to the clearing of vegetation adjacent to the South Fork American River Bridge for staging areas and temporary access. Permanent removal of riparian vegetation must be avoided. In areas where temporary impacts to riparian vegetation are necessary, the riparian vegetation will be trimmed to ground level to allow regeneration. Fencing to protect environmentally sensitive areas (ESA) will be included in the Project Plans Specifications and Plans. ESA fencing is estimated to cost \$3,000. Removing riparian vegetation has potential to create permanent impacts to the habitat in these areas. If riparian habitat is will be removed, then CDFG 1602 permit and either onsite or offsite mitigation would be required. The cost for purchasing riparian habitat at a mitigation bank is approximately \$45,000 per acre at a replacement value of 3:1. If offsite mitigation is required, the cost for purchasing at a mitigation bank is estimated to be \$337,500. In addition, Caltrans would be expected to restore as much riparian habitat as possible within the riparian corridor of the South Fork of the American River, also at a 3:1 ratio. Design and implementation of onsite mitigation would cost approximately \$35,000 per acre. The cost for onsite mitigation is estimated to be \$257,250.

The work over the South Fork of the American River will be fully contained and no debris will be allowed to enter the waterway. The work will require temporary construction access on the banks of the river. A United States Army Corps of Engineers (USACE), Section 404, Nationwide Permit 33 will be required. In addition, based on the given 2.45 acres of disturbed soil, a Water Quality Control Board (WQCB) Section 401 Water Quality Certification will be required with a cost of \$7,382.

Impacts to oak woodlands along this segment of Hwy 49 are estimated at .25 acres. This estimate includes an area with blue oak habitat within the Caltrans right of way. To comply with Senate Concurrent Resolution 17 (SCR 17) regarding the loss of the blue oak trees, Caltrans will be required, by the CDFG, to a) replant seedlings either on-site or off-site, b) provide compensatory replacement at an approved mitigation bank, or c) preserve existing blue oak habitat within or near El Dorado County. Regardless of what type of replacement is ultimately required, the estimated cost for replacement of these oak trees will be approximately \$10,000 per acre for a total of \$2,500 for .25 acres of blue oak woodland/savannah creation. If

preservation is required, the cost for purchasing property is estimated at \$15,000 per acre for a total \$3,750 for .25 acres.

9. Summary Statement for PSR or PSR-PDS

In order to identify environmental issues, constraints, costs and resource needs, the Environmental Management Branch (M-3) has prepared a Preliminary Environmental Analysis Report (PEAR) for the project. Based on current information, it is anticipated that an environmental study must be completed to determine the appropriate environmental documentation for this project. The document is expected to be a Negative Declaration pursuant to the California Environmental Quality Act (CEQA) and a Categorical Exclusion pursuant to the National Environmental Policy Act (NEPA).

If the area below the South Fork American River Bridge is not utilized for staging and construction access, then it is anticipated that the environmental document will be a Categorical Exemption (CEQA) and a Categorical Exclusion (NEPA), with no permits, for this project.

Potential impacts requiring further study include:

- Biological Resources
- Hazardous Waste
- Water Quality
- Landscape/Visual Impacts
- Cultural Resources

10. Disclaimer

This Preliminary Environmental Analysis Report (PEAR) provides information to support programming of the proposed project. It is not an environmental determination or document. Preliminary analysis, determinations, and estimates of mitigation costs are based on the project description provided in the Project Study Report (PSR). The estimates and conclusions in the PEAR are approximate and are based on cursory analyses of probable effects. A reevaluation of the PEAR will be needed for changes in project scope or alternatives, or in environmental laws, regulations, or guidelines.

11. List of Preparers

Cultural Resources Specialist Erick Wulf	Date: 4-1-09
Biologist Gary Grunder	Date: 8-24-09
Community Impacts Specialist Alicia Boomer	Date: 11-12-08
Noise and Vibration Specialist Saied Zandian	Date: 10-8-08
Air Quality Specialist Sharon Tang	Date: 2-11-09
Paleontology Specialist/Liaison	Date: N/A

N/A	
Water Quality Specialist Aaron Bennett	Date: 12-4-08
Hydrology and Floodplain Specialist Gurdeep Bhattal	Date: 11-4-08
Hazardous Waste/Materials Specialist Alicia Beyer	Date: 9-3-08 updated 8-18-09
Visual/Aesthetics Specialist Kathleen Grady	Date: 8-20-09
Energy and Climate Change Specialist Sharon Tang	Date: 2-11-09
PEAR Preparer Denise Gibson, Associate Environmental Planner	Date: 8-24-09

12. Review and Approval

I confirm that environmental cost, scope, and schedule have been satisfactorily completed and that the PEAR meets all Caltrans requirements. Also, if the project is scoped as an EA or EIS, I verify that the HQ DEA Coordinator has concurred in the Class of Action.

Kendall Schenk
Environmental Branch Chief

Date: 8-27-09

Sergio Acero
Project Manager

Date: 8-27-09

for Clark Peri

REQUIRED ATTACHMENTS:

Attachment A: PEAR Environmental Studies Checklist

Attachment B: Estimated Resources by WBS Code

Attachment C: Schedule (Gantt Chart) Unable to obtain at this time

Attachment D: PEAR Environmental Commitments Cost Estimate (Standard PSR)

Attachment A: PEAR Environmental Studies Checklist

Rev. 11/08

Environmental Studies for PA&ED Checklist					
	Not anticipated	Memo to file	Report required	Risk* L M H	Comments
Land Use	<input checked="" type="checkbox"/>	<input type="checkbox"/>	<input type="checkbox"/>	L	
Growth	<input checked="" type="checkbox"/>	<input type="checkbox"/>	<input type="checkbox"/>	L	
Farmlands/Timberlands	<input checked="" type="checkbox"/>	<input type="checkbox"/>	<input type="checkbox"/>	L	
Community Impacts	<input type="checkbox"/>	<input checked="" type="checkbox"/>	<input type="checkbox"/>	L	
Community Character and Cohesion	<input checked="" type="checkbox"/>	<input type="checkbox"/>	<input type="checkbox"/>	L	
Relocations	<input checked="" type="checkbox"/>	<input type="checkbox"/>	<input type="checkbox"/>	L	
Environmental Justice	<input checked="" type="checkbox"/>	<input type="checkbox"/>	<input type="checkbox"/>	L	
Utilities/Emergency Services	<input checked="" type="checkbox"/>	<input type="checkbox"/>	<input type="checkbox"/>	L	
Visual/Aesthetics	<input type="checkbox"/>	<input type="checkbox"/>	<input checked="" type="checkbox"/>	L	
Cultural Resources:	<input type="checkbox"/>	<input type="checkbox"/>	<input checked="" type="checkbox"/>	L	
Archaeological Survey Report	<input type="checkbox"/>	<input type="checkbox"/>	<input checked="" type="checkbox"/>	L	
Historic Resources Evaluation Report	<input type="checkbox"/>	<input type="checkbox"/>	<input checked="" type="checkbox"/>	L	
Historic Property Survey Report	<input checked="" type="checkbox"/>	<input type="checkbox"/>	<input type="checkbox"/>	L	
Historic Resource Compliance Report	<input checked="" type="checkbox"/>	<input type="checkbox"/>	<input type="checkbox"/>	L	
Section 106 / PRC 5024 & 5024.5	<input type="checkbox"/>	<input checked="" type="checkbox"/>	<input type="checkbox"/>	L	
Native American Coordination	<input checked="" type="checkbox"/>	<input type="checkbox"/>	<input type="checkbox"/>	L	
Finding of Effect	<input checked="" type="checkbox"/>	<input type="checkbox"/>	<input type="checkbox"/>	L	
Data Recovery Plan	<input checked="" type="checkbox"/>	<input type="checkbox"/>	<input type="checkbox"/>	L	
Memorandum of Agreement	<input checked="" type="checkbox"/>	<input type="checkbox"/>	<input type="checkbox"/>	L	
Other: if needed	<input type="checkbox"/>	<input type="checkbox"/>	<input type="checkbox"/>	L	
Hydrology and Floodplain	<input type="checkbox"/>	<input type="checkbox"/>	<input checked="" type="checkbox"/>	L	rec Nov 08
Water Quality and Stormwater Runoff	<input type="checkbox"/>	<input type="checkbox"/>	<input checked="" type="checkbox"/>	L	
Geology, Soils, Seismic and Topography	<input checked="" type="checkbox"/>	<input type="checkbox"/>	<input type="checkbox"/>	L	
Paleontology	<input checked="" type="checkbox"/>	<input type="checkbox"/>	<input type="checkbox"/>	L	
PER	<input checked="" type="checkbox"/>	<input type="checkbox"/>	<input type="checkbox"/>	L	
PMP	<input checked="" type="checkbox"/>	<input type="checkbox"/>	<input type="checkbox"/>	L	
Hazardous Waste/Materials:	<input type="checkbox"/>	<input type="checkbox"/>	<input checked="" type="checkbox"/>	L	
ISA (Additional)	<input type="checkbox"/>	<input type="checkbox"/>	<input checked="" type="checkbox"/>	L	
PSI	<input checked="" type="checkbox"/>	<input type="checkbox"/>	<input type="checkbox"/>	L	
Other:	<input type="checkbox"/>	<input type="checkbox"/>	<input checked="" type="checkbox"/>	L	LCP, ACPw
Air Quality	<input type="checkbox"/>	<input type="checkbox"/>	<input checked="" type="checkbox"/>	L	
Noise and Vibration	<input type="checkbox"/>	<input type="checkbox"/>	<input checked="" type="checkbox"/>	L	
Energy and Climate Change	<input checked="" type="checkbox"/>	<input type="checkbox"/>	<input type="checkbox"/>	L	
Biological Environment	<input type="checkbox"/>	<input type="checkbox"/>	<input checked="" type="checkbox"/>	L	
Natural Environment Study	<input type="checkbox"/>	<input type="checkbox"/>	<input checked="" type="checkbox"/>	L	
Section 7:	<input checked="" type="checkbox"/>	<input type="checkbox"/>	<input type="checkbox"/>	L	
Formal	<input checked="" type="checkbox"/>	<input type="checkbox"/>	<input type="checkbox"/>	L	
Informal	<input checked="" type="checkbox"/>	<input type="checkbox"/>	<input type="checkbox"/>	L	
No effect	<input checked="" type="checkbox"/>	<input type="checkbox"/>	<input type="checkbox"/>	L	
Section 10	<input checked="" type="checkbox"/>	<input type="checkbox"/>	<input type="checkbox"/>	L	
USFWS Consultation	<input checked="" type="checkbox"/>	<input type="checkbox"/>	<input type="checkbox"/>	L	
NMFS Consultation	<input checked="" type="checkbox"/>	<input type="checkbox"/>	<input type="checkbox"/>	L	
Species of Concern (CNPS, USFS, BLM, S, F)	<input checked="" type="checkbox"/>	<input type="checkbox"/>	<input type="checkbox"/>	L	

Environmental Studies for PA&ED Checklist					
	Not anticipated	Memo to file	Report required	Risk* L M H	Comments
Wetlands & Other Waters/Delineation	<input type="checkbox"/>	<input type="checkbox"/>	<input checked="" type="checkbox"/>	<u>L</u>	
404(b)(1) Alternatives Analysis	<input checked="" type="checkbox"/>	<input type="checkbox"/>	<input type="checkbox"/>	<u>L</u>	
Invasive Species	<input type="checkbox"/>	<input checked="" type="checkbox"/>	<input type="checkbox"/>	<u>L</u>	
Wild & Scenic River Consistency	<input checked="" type="checkbox"/>	<input type="checkbox"/>	<input type="checkbox"/>	<u>L</u>	
Coastal Management Plan	<input checked="" type="checkbox"/>	<input type="checkbox"/>	<input type="checkbox"/>	<u>L</u>	
HMMP	<input checked="" type="checkbox"/>	<input type="checkbox"/>	<input type="checkbox"/>	<u>L</u>	
DFG Consistency Determination	<input checked="" type="checkbox"/>	<input type="checkbox"/>	<input type="checkbox"/>	<u>L</u>	
2081	<input checked="" type="checkbox"/>	<input type="checkbox"/>	<input type="checkbox"/>	<u>L</u>	
Other:	<input type="checkbox"/>	<input type="checkbox"/>	<input type="checkbox"/>	<u>L</u>	
Cumulative Impacts	<input checked="" type="checkbox"/>	<input type="checkbox"/>	<input type="checkbox"/>	<u>L</u>	
Context Sensitive Solutions	<input type="checkbox"/>	<input checked="" type="checkbox"/>	<input type="checkbox"/>	<u>L</u>	
Section 4(f) Evaluation	<input checked="" type="checkbox"/>	<input type="checkbox"/>	<input type="checkbox"/>	<u>L</u>	
Permits:					
401 Certification Coordination	<input type="checkbox"/>	<input type="checkbox"/>	<input checked="" type="checkbox"/>	<u>L</u>	
404 Permit Coordination, IP, NWP, or LOP	<input type="checkbox"/>	<input type="checkbox"/>	<input checked="" type="checkbox"/>	<u>L</u>	NW 33
1602 Agreement Coordination	<input type="checkbox"/>	<input type="checkbox"/>	<input checked="" type="checkbox"/>	<u>L</u>	
Local Coastal Development Permit Coordination	<input checked="" type="checkbox"/>	<input type="checkbox"/>	<input type="checkbox"/>	<u>L</u>	
State Coastal Development Permit Coordination	<input checked="" type="checkbox"/>	<input type="checkbox"/>	<input type="checkbox"/>	<u>L</u>	
NPDES Coordination	<input checked="" type="checkbox"/>	<input type="checkbox"/>	<input type="checkbox"/>	<u>L</u>	
US Coast Guard (Section 10)	<input checked="" type="checkbox"/>	<input type="checkbox"/>	<input type="checkbox"/>	<u>L</u>	
TRPA	<input checked="" type="checkbox"/>	<input type="checkbox"/>	<input type="checkbox"/>	<u>L</u>	
BCDC	<input checked="" type="checkbox"/>	<input type="checkbox"/>	<input type="checkbox"/>	<u>L</u>	

Attachment D: PEAR Environmental Commitments Cost Estimate

Standard PSR Only

(Prepare a separate form for each viable alternative described in the Project Study Report)

PART 1 PROJECT INFORMATION

rev. 11/08

District-County-Route-Post Mile 03-ED-49-23.99	EA: 03-0F310K
Project Description: Seismic Retrofit and bridge railing replacement of the South Fork American River Bridge (Br. No. 25-0021)	
Form completed by (Name/District Office): Denise Gibson / District 3 -Marysville	
Project Manager: Clark Peri	Phone Number: (916)274-0538
Date: August 24, 2009	

PART 2 PERMITS AND AGREEMENTS

	Permits and Agreements (\$\$)
<input checked="" type="checkbox"/> Fish and Game 1602 Agreement	4000
<input type="checkbox"/> Coastal Development Permit	0
<input type="checkbox"/> State Lands Agreement	0
<input checked="" type="checkbox"/> Section 401 Water Quality Certification	7382
<input checked="" type="checkbox"/> Section 404 Permit – Nationwide (U.S. Army Corps)	0
<input type="checkbox"/> Section 404 Permit – Individual (U.S. Army Corps)	0
<input type="checkbox"/> Section 10 Navigable Waters Permit (U.S. Army Corps)	0
<input type="checkbox"/> Section 9 Permit (U.S. Coast Guard)	0
<input type="checkbox"/> Other:	0
Total (enter zeros if no cost)	11382

PART 3. ENVIRONMENTAL COMMITMENTS FOR PERMANENT IMPACTS

To complete the following information:

- Report costs in \$1,000s.
- Include all costs to complete the commitment:
 - Capital outlay and staff support. Refer to Estimated Resources by WBS Code. For example, if you estimated 80 hours for biological monitoring (WBS 235.35 Long Term Mitigation Monitoring), convert those hours to a dollar amount for this entry. For current conversion rates from PY to dollars, see the Project Manager.
 - Cost of right of way or easements.
 - If compensatory mitigation is anticipated (for wetlands, for example), insert a range for purchasing credits in a mitigation bank.
 - Long-term monitoring and reporting
 - Any follow-up maintenance
 - Use current costs; the Project Manager will add an appropriate escalation factor.
 - This is an estimating tool, so a range is not only acceptable, but advisable.

Environmental Commitments Alternative All		
	Estimated Cost in \$1,000's	Notes
Noise abatement or mitigation	0	
Special landscaping		1
Archaeological resources	0	
Biological resources	57	Migratory Bird Exclusionary Devices - on South Fork of the American River Bridge- (\$50,000) Bats and swallows. Oak Woodland (\$4,000).ESA fencing for riparian protection (\$3,000).
Historical resources	0	
Scenic resources	0	
Wetland/riparian resources	269	DFG/WQCB permits and mitigation
Res./bus. relocations	0	
Other: Haz Waste	6.5	PSI ACP, LCP
Total (enter zeros if no cost)	332.5	

ATTACHMENT F

INITIAL SITE ASSESSMENT (HAZARDOUS WASTE)

Memorandum

Date: August 18, 2009

File: 03-ED-49
PM 23.99
EA 0F310K

To: DENISE GIBSON
Environmental Coordinator

From: MARIA ALICIA BEYER
Office of Environmental Engineering South
Hazardous Waste

Subject: Hazardous Waste Initial Site Assessment for a PEAR

The proposed bridge railing upgrade, deck rehabilitation and seismic retrofit of the South Fork American River Bridge No. 25-0021 will involve the following structure construction activities:

Barrier Railing Replacement.

The contractor will construct formwork and a protective cover below the existing deck overhang. This will be supported from the existing bridge girders.

Contractor will access the area alongside and below the bridge west of the river from an existing gravel road located at the southwest quadrant of the bridge to the right of Abutment 1. Some minor grading and brush trimming will be needed to improve access to the bridge.

Manlifts will be used to install this formwork from below the bridge except in areas over the active river that can not be reached from the bank. Areas over the river will be installed from the bridge deck using an under bridge access truck.

Areas at the east end of the bridge in span 7 could be accessed by an existing path at the northeast quadrant to the left of Abutment 8. The path could be improved with minor grading to accommodate small equipment such as a manlift.

The existing barrier and portion of the deck overhang will be removed by saw cutting and demolition with jack hammers and a backhoe mounted jack hammer.

Deck Rehabilitation

Existing AC surfacing on the bridge deck will be removed by grinding.

Deck surface will be cleaned using shot blasting equipment.

Deck will be treated with methacrylate resin and a 0.75 inch thick polyester concrete overlay will be placed using paving equipment.

Seismic Retrofit

The existing cross bracing located between the steel girders near the abutments and piers will be strengthened by adding additional steel bracing members. These will be either bolted or welded into place.

Steel plates will be added to the top flange of the girders at the hinge locations to restrain lateral movement. These will be welded into place.

Paint will be removed in areas to be welded by blast cleaning. All debris will be contained. After welding, bare metal areas will be painted.

Access for this work will be from below the bridge except for the hinges in span 5 over the water which will be accessed from the bridge deck.

Temporary construction easements and equipment staging area may be required. No disposal of excavated material outside the project limits is involved.

ISA Conclusions:

1. Records review.

The hazardous waste investigation for this PEAR, was limited to a records review, State's Steel Bridges database review, and a Site Investigation for Naturally Occurring Asbestos (NOA), Aerially Deposited Lead (ADL) and Lead/Chromium based paint site investigation, performed by Geocon, Inc. (during 2004 for project EA 03-ED-49, PM 24.1/24.6, EA 2C3600 under Task Order No. 04, Contract 03A0937) .

Based on the nature of the project work scope, no significant hazardous waste is expected to be encountered within the project limits. Appropriate Standard Special Provisions should be included in the project's construction contract.

2. Aerially Deposited Lead (ADL)

Between PM 24.1 and PM 24.6, Total lead was detected at concentrations at or above the laboratory method detection limit in 52 of the 115 soil samples tested. Total lead concentrations ranged from non-detect to 140 mg/kg. Soil pH values ranged from 6.76 to 8.71.

A Lead Compliance Plan for ADL is required. The contractor shall prepare and submit a project specific "Lead Compliance Plan" under Section 7-1.07, "Lead compliance Plan," of the Standard Specifications and use SSP 15-027 LCP.

ADL Waste Disposal/Soil Reuse Classification:

Soil materials excavated to a maximum depth of 0.8 m (2.6 ft) bgs may be reused onsite without restrictions based on lead content since the 90% and 95% total lead UCLs for each layer are less than 50 mg/kg (ten times the STLC value for lead of 5.0 milligrams per liter).

3. Traffic Stripe -Lead/Chromium Based Paint

Between PM 24.1 and PM 24.6, four traffic stripe paint chip samples collected and were reported to contained total lead and total chromium in excess of the laboratory method detection limit. Total lead was reported at values ranging from 26 to 76 mg/kg and total chromium was reported at values ranging from 21 to 38 mg/kg.

Two of the samples were had reported total lead concentrations greater than 50 mg/kg (ten times the STLC value for lead of 5.0 milligrams per liter). The samples were further analyzed for soluble lead by the WET method. Neither sample contained soluble lead at or above the STLC value of 5.0 mg/l.

The Contractor is required to properly manage removed stripe and pavement marking and shall implement a project specific lead compliance plan prepared by a Certified Industrial Hygienist (CIH) as required by Cal/OSHA.

The actual text containing the requirements for the lead compliance plan is found in the Amendments to the 2006 Standard Specifications in Section 7-1.07. Use BEES Item Code 190110. (Note that just one lead compliance plan that addresses all lead exposures on the project should be prepared, so the quantity should only be one.)

Use Standard Special Provision (SSP) 14-001 if the project includes separate removal of yellow paint or yellow thermoplastic paint from the rad surface.

Use SSP 15-305 if yellow paint or yellow thermoplastic paint will be removed while grinding the entire pavement surface, and the project will not require the paint or thermoplastic paint to be removed before grinding begins.

4. Structure - Lead/Chromium Based Paint.

State's steel bridges database provided by John C Rogers from HQ shows that the South Fork American River, Bridge No. 25-0021 has "Zinc Chromate Lead based paint." Sampling and testing the lead-based paint will be performed under a Task Order. A Lead Compliance Plan N-SSP for lead based paint and debris containment Special Provisions approved by HQ are required.

5. Naturally Occurring Asbestos (NOA)

The mapped and observed geology of the Site is not indicative of a metamorphic regime where NOA minerals are likely to occur. Outcrops with documented occurrences of NOA are mapped approximately 1.2 km (0.76 mi) to the northeast and 2.0 km (1.3 mi) to the south-southwest of the Site. NOA was not reported at or above 0.25 percent in the eleven samples analyzed. However, one sample collected was reported to contain NOA trace, less than 0.25 percent chrysotile. (ref. Geocon report, sec. 6.1 p.14)

Though material containing NOA at or above 0.25 percent is unlikely on the Site, the following conclusions and recommendations are applicable if subsequent work reveals the presence of such NOA containing materials. NOA is a State of California regulated substance.

In the unlikely event that NOA is discovered at levels exceeding the CARB (California Air Resources Board) regulatory limit of 0.25 percent NOA content, the excavated materials cannot be used as, or in such a way that it could fall under the definition of surfacing material as defined by the CARB Rules.

Non-Standard Special Provisions (NOA minor) apply for minor soils disturbance in soils potentially containing NOA. This N-SSP minor for NOA, required HQ approval. Engineering controls such as wet suppression must be utilized to minimize aerial dispersion of NOA fibers in planned work areas during excavation and road construction activities.

Under Title 8 Section 5208 of the California Code of Regulations (CCR), disturbance of asbestos containing materials requires wet working methods and possible respiratory protection and air monitoring. El Dorado County has also implemented guidelines and regulations for handling and disposal of NOA containing materials. Contractors handling asbestos containing material should consult Title 17, Section 93105, and contact the El Dorado County Environmental Management Department and the California Occupational Safety and Health Administration to establish the appropriate regulatory protocol and actions necessary for excavation and/or disturbance of asbestos containing soils.

6. NESHAP Notification.

A special provision shall be added to the contract to address NESHAP notification. "The Contractor shall prepare bridge seismic retrofit modification notification form and attachments to be submitted to the California Air Resource Board, Compliance Division, (2020 'L' Street, Sacramento, CA 95814,) as required by NESHAP, 40CFR Part 61, and California Air Resources Control Board rules."

7. Treated Wood Waste

Treated wood waste (TWW) can occur as post along metal beam guard railing (MBGR), thrie beam barrier, piles, or roadside signs. These wood products are typically treated with preserving chemicals that may be hazardous (carcinogenic) and include but are not limited to arsenic, chromium, copper, creosote, and pentachlorophenol. The Department of Toxics Substances Control (DTSC) requires that TWW either be disposed as a hazardous waste, or if not tested, the generator may presume that TWW is a hazardous waste . Use SSP 14-010.

The Contractor shall prepare a detailed Health, Safety and Work Plan for all site personnel in accordance with the DTSC and CAL-OSHA regulations.

Treated wood waste must be disposed in an approved treated wood waste facility.

Current regulations allow for disposal of untested treated wood waste (TWW) in either a Class I hazardous waste landfill, or a composite-lined portion of a solid waste landfill unit that meets all requirements applicable to disposal of municipal solid waste and that is regulated by waste discharge requirements issued for discharges of designated waste or TWW.

8. Estimate cost and bid items that need to be included in the BEES:

- For the preliminary estimate of cost purposes, the required Health and Safety Plan covering: Lead Compliance Section 15-32.1 (ADL), Yellow traffic stripe removal, Structure Zinc Chromate Lead based paint, and remove and dispose of TWW is \$3,000.
- For the preliminary estimate of cost purposes, the required N-SSP for structure lead based paint "Debris Containment & Disposal" is \$...?
- For the preliminary estimate of cost purposes, the required N-SSP for Asbestos Compliance Plan (ACP) and Dust Control Plan (DCP) is \$3,500.

If you have any questions, do not hesitate to give me a call at (530) 741-4580.

cc: Molly Richard – Project Engineer - Advance Planning

ATTACHMENT G

TRAFFIC MANAGEMENT PLAN DATA SHEET

Memorandum

*Flex your power!
Be energy efficient!*

To: CHAD BAKER
Project Engineer

Date: February 4, 2009

File: 03-0F310K
ED-49-PM 23.99
Seismic Retrofit

From: SUDHA KODALI
TMP Coordinator
District 3-Office of Transportation Management Planning

Subject: Transportation Management Plan (TMP) Data Sheet

Background

- This project is located in El Dorado County on SR 49. The stretch of roadway within the project limits consists of a 2-lane conventional highway with minimal shoulder widths. This project proposes the following two alternatives for the South Fork American River Bridge (Br. No. 25 0021):
 1. Seismic Retrofit, Rail Upgrade, MBGR replacement at south end. This option will require a design exception for shoulder and sidewalk widths.
 2. Seismic Retrofit, Rail Upgrade, MBGR replacement at both ends and bridge widening with imported borrow.
- For detail description of locations, traffic volumes, refer to **Table-1**.

Table-1: Traffic Volumes (2007 Traffic Volumes on California State Highways)				
Location Description	Multilane Roadway	2-Lane, 2-Way Roadway	Peak-Hour (both directions combined)	AADT
03-ED-49-PM/22.87		X	500 vph	5,400 vpd

Recommendation

- This location is subject to pedestrian and bicycle recreational traffic. Consideration should be made for widening the structure to allow improved access for pedestrians and bicyclists.
- One lane that is at least 11 foot wide shall remain open at all times.
- A minimum of a 4 foot shoulder shall remain open at all times for pedestrian and bicycle use.
- One-way (reversible) traffic control in accordance with Standard Plan sheet T13 may be allowed Monday through Sunday at all times.
- Stage construction with K-rail will be necessary for bridge rail replacement.
- Consider using a temporary traffic signal to control traffic when the bridge is reduced to one lane open.
- When closures occur within 200 ft of an intersection, flaggers will need to be deployed to control all legs of the intersection.
- Advance flaggers are recommended in areas where there is inadequate approaching sight distance.
- K-rail shall be secured in place prior to allowing traffic on the bridge when bridge rail has been removed.
- The maximum length of any lane closure shall be limited to 0.5 mile.
- No lane closures, shoulder closures, or other traffic restrictions will be allowed on Special Days, designated legal holidays and the day preceding designated legal holidays; and when construction operations are not actively in progress.
- Access to driveways and cross streets must be maintained during construction, in accordance with traffic control standard plans or traffic handling provided in the contract plans.
- Pedestrian and bicycle traffic access will be required to be maintained. Signs will direct the public accordingly when sidewalks and bikeways are closed for the contract work.
- Portable changeable message signs will be required in direction of traffic during construction for each lane, shoulder and bridge closure.
- Work at this location may require the assistance of COZEEP, but probably not a full time presence.
- If there is a change in the scope of the project or the order of work (schedule), please advise the TMP unit, as this may affect the TMP estimate.
- Lane closure charts will have to be developed prior to P&E.

Cost

- For estimating purposes, use \$2,800 per working day to estimate the costs that are required for the Traffic Management Plan (TMP) items. These items include:
 - Traffic Control System: \$1,800 per day
 - Portable Changeable Message Signs: \$500 per day

CHAD BAKER
February 4, 2009
Page 3

- Maintain Traffic: \$500 per day
- COZEEP is estimated at \$1,000 per working day and \$2,000 per working night whenever CHP involvement is needed during construction. COZEEP estimate should include 2 officers per vehicle when performing night work.
- If there is a change in the scope of the project or the order of work (schedule), please advise the TMP unit, as this may affect the TMP estimate.

P & E Requirement

To complete a TMP for this project, please provide the following to the Office of Traffic Management Planning at least three months prior to P&E: project description, title sheet, typical cross sections, layout sheets, construction cost estimates, number of working days, project schedule, and a contact person.

Needed Resources

TMP office will need the following resources to complete our work:

Activity 160	40 hours
Activity 230	100 hours
Activity 255	30 hours
Activity 265	10 hours
Activity 270	10 hours
Activity 285	4 hours

D-3 TRANSPORTATION MANAGEMENT PLAN CHECKLIST

District / EA: 03-0F310K
Date Prepared: January 30, 2009
Prepared By: Sudha Kodail

Co.Rte.-PM.(KP) ED-49-PM 23.99
Location South Fork American River Bridge (Br. No. 25-0021)

Stage of Project (X box) PID PSR PR PS&E

Description: Seismic Retrofit

1.0 Public Information Strategies

- 1.1 Brochures and Mailers
- 1.2 Media Releases (& minority media sources)
- 1.3 Paid Advertising
- 1.4 Public Information Center
- 1.5 Public Meetings/Speakers Bureau
- 1.6 Project Telephone Hotline
- 1.7 Internet, E-Mail
- 1.8 Local cable TV and News
- 1.9 Notification to Impacted groups
(i.e. bicycle users, pedestrians with disabilities, others)
- 1.10 Project Web Page
- 1.11 Caltrans Public Information Office
- 1.12 Consultant Public Information Office
- 1.13 Other items

REQUIRED	RECOMMENDED	NOT APPLICABLE	BEES Item No.	COMMENTS	UNIT COST	REQUIRED IN SPEC.
	<input checked="" type="checkbox"/>			For Adjacent Property Owners		
	<input checked="" type="checkbox"/>					
		<input checked="" type="checkbox"/>				
		<input checked="" type="checkbox"/>				
		<input checked="" type="checkbox"/>	066063			
		<input checked="" type="checkbox"/>				
		<input checked="" type="checkbox"/>				
		<input checked="" type="checkbox"/>				
		<input checked="" type="checkbox"/>				
		<input checked="" type="checkbox"/>				
		<input checked="" type="checkbox"/>	066063			
		<input checked="" type="checkbox"/>				
		<input checked="" type="checkbox"/>				

2.0 Traveler Information Strategies

- 2.1 Changeable Message Signs (permanent)
- 2.2 Changeable Message Signs (portable)
- 2.3 Special Construction Signs
- 2.4 Traveler Information Systems (CHIN/Internet)
- 2.5 Highway Advisory Radio "HAR" (fixed or mobile)
- 2.6 Radar Speed Sign
- 2.7 Traffic Management Team
- 2.8 Revised Transit Schedules/ Maps
- 2.9 Bicycle community information
- 2.10 Other item

	<input checked="" type="checkbox"/>			If Available in vicinity		
<input checked="" type="checkbox"/>			128650			<input checked="" type="checkbox"/>
<input checked="" type="checkbox"/>			120690			
		<input checked="" type="checkbox"/>	861985			
	<input checked="" type="checkbox"/>		860520	If Available		
		<input checked="" type="checkbox"/>	066064			
		<input checked="" type="checkbox"/>				
		<input checked="" type="checkbox"/>				
	<input checked="" type="checkbox"/>					
		<input checked="" type="checkbox"/>				

3.0 Incident Management

- 3.1 COZEOP
- 3.2 Freeway Service Patrol (tow truck service patrol)
- 3.3 Traffic Surveillance Stations (loops or CCTV)
- 3.4 Transportation Management Center
- 3.5 Traffic Control Inspector (Caltrans)
- 3.6 Traffic Management Team
- 3.7 On-site Traffic Advisor (contractor)
- 3.8 Other Items

<input checked="" type="checkbox"/>			066062	During Construction		
		<input checked="" type="checkbox"/>	066065			
		<input checked="" type="checkbox"/>	066876			
		<input checked="" type="checkbox"/>				
		<input checked="" type="checkbox"/>				
		<input checked="" type="checkbox"/>				
		<input checked="" type="checkbox"/>				
		<input checked="" type="checkbox"/>				

4.0 Construction Strategies

- 4.1 Delay damage clause
- 4.2 Night work
- 4.3 Weekend Work
- 4.4 Extended Weekend Closures
- 4.5 Planned Lane Closures
- 4.6 Planned Ramp/Connector Closures
- 4.7 Total Facility Closure
- 4.8 Project Phasing
- 4.9 Truck Traffic Restrictions
- 4.10 Reduced Lane Widths

		<input checked="" type="checkbox"/>				
	<input checked="" type="checkbox"/>					
	<input checked="" type="checkbox"/>					
		<input checked="" type="checkbox"/>				
<input checked="" type="checkbox"/>				Per Lane Closure Charts		<input checked="" type="checkbox"/>
		<input checked="" type="checkbox"/>				
		<input checked="" type="checkbox"/>				
		<input checked="" type="checkbox"/>				
		<input checked="" type="checkbox"/>				

4.0 Construction Strategies (Continued)

- 4.11 Temporary K-Rail
- 4.12 Temporary Traffic Screens
- 4.13 Reduced Speed Zones
- 4.14 Traffic Control Improvements
- 4.15 Contingency Plans
 - 4.15.1 Material Plant on standby
 - 4.15.2 Extra Critical Equipment on site
 - 4.15.3 Material Testing Plan
 - 4.15.4 Alternate Material on site
(In case of failure or major delays)
 - 4.15.5 Emergency Detour Plan
 - 4.15.6 Emergency Notification Plan
 - 4.15.7 Weather Conditions Plan
 - 4.15.8 Delay Timing and Documentation Plan
 - 4.15.9 Late Closure Reopening Notification
- 4.16 Signal timing modification
- 4.17 Coordination with adjacent construction
- 4.18 Double Fine Zone (signs)
- 4.19 Right of Way Delay
- 4.20 Other Items

REQUIRED	RECOMMENDED	NOT APPLICABLE	BEEES Item No.	COMMENTS	UNIT COST	REQUIRED IN SPEC.
X			129000	For Bridge rail work		X
	X		129150	If K-rail is used		
		X				
		X				
X						X
		X				
		X				
		X				
		X				
	X					
	X					
		X				
		X				
		X				
X						X
	X					
		X	066022			
		X				

5.0 Demand Management

- 5.1 HOV Lanes/Ramps
- 5.2 Ramp metering
- 5.3 Park-and-Ride Lots
- 5.4 Parking Management/Pricing
- 5.5 Rideshare Incentives
- 5.6 Rideshare Marketing
- 5.7 Transit, Train, or Light-Rail Incentives
- 5.8 Transit Service Modification
- 5.9 Variable Work Hours
- 5.10 Telecommute
- 5.11 Other Items

		X				
		X				
		X				
		X				
		X				
	X		066069			
	X		066066			
		X				
		X				
		X				

6.0 Alternate Route Strategies

- 6.1 Ramp Closures
- 6.2 Street Improvements
- 6.3 Reversible Lanes
- 6.4 Temporary Lanes or Shoulders Use
- 6.5 Freeway to freeway connector closures
- 6.6 Encroachment Permit from City/County

		X				
		X				
X						
		X				
		X				
		X				

7.0 Other Strategies

- 7.1 Application of new technology
- 7.2 Other Items

		X				
		X				

Comments: _____

**Chart No. 1
Conventional Highway Lane Requirements**

County: El Dorado		Route/Direction: ED-49-NB/SB										PM: 23.99															
Closure Limits: PM 23.74/24.24																											
FROM HOUR TO HOUR		24	1	2	3	4	5	6	7	8	9	10	11	12	13	14	15	16	17	18	19	20	21	22	23	24	
Mondays through Thursdays		R	R	R	R	R	R	R	R	R	R	R	R	R	R	R	R	R	R	R	R	R	R	R	R	R	R
Fridays		R	R	R	R	R	R	R	R	R	R	R	R	R	R	R	R	R	R	R	R	R	R	R	R	R	R
Saturdays		R	R	R	R	R	R	R	R	R	R	R	R	R	R	R	R	R	R	R	R	R	R	R	R	R	R
Sundays		R	R	R	R	R	R	R	R	R	R	R	R	R	R	R	R	R	R	R	R	R	R	R	R	R	R
Legend:																											
R		Provide at least one through lane and one shoulder open for use by both directions of travel (Reversing Control). The lane shall be a minimum of 11 feet in width. The shoulder shall be a minimum of 4 feet in width																									
REMARKS:																											

ATTACHMENT H

LANDSCAPE ARCHITECTURE ASSESSMENT SHEET



**NORTH REGION
LANDSCAPE ARCHITECTURE ASSESSMENT SHEET**
03-LAND-0002 (Rev. 3/03)

TO: Ferdinand Batatan FROM: Kathleen Grady Unit/Senior TE Name: 216/ Chad Baker Project Manager: Clark Peri	CO: ED DISTRICT: 03 DATE: 4/20/09 EA: 0F310K	RTE: 49	PM 23.99:
PROJECT SEPARATION: <input checked="" type="checkbox"/> Landscape as part of roadway work EA <input type="checkbox"/> Landscape under separate EA (Follow-up)		PROJECT: Seismic Retrofit fro Bridge #25-0021 TYPE: SHOPP PROJECT MILESTONE: PID	

PROJECT DESCRIPTION: Seismic retrofit and rail upgrade of South Fork American bridge (Br No. 25-0021). Seismic retrofit and raiiling upgrade, a design exception will be pursued for non-standard shoulder and sidewalk widths.

AREA (Sq.Ft.) FOR HIGHWAY PLANTING: AREA (Sq.Ft.) FOR EROSION CONTROL:	14,520 Sq. Ft. (ground disturbance) + 108,900 Sq. Ft. (2.5 Ac staging area)
PLANT COUNT FOR MITIGATION PLANTING:	
LANDSCAPE FREEWAY STATUS: HIGHWAY PLANTING IS: SCENIC HIGHWAY STATUS: REVEGETATION REQUIRED?	<input type="checkbox"/> Yes <input type="checkbox"/> Warranted <input type="checkbox"/> Officially Designated <input type="checkbox"/> Permit Required
	<input checked="" type="checkbox"/> No <input type="checkbox"/> Not Warranted <input checked="" type="checkbox"/> Eligible <input type="checkbox"/> Offset of Visual Impact
	<input type="checkbox"/> Not Designated <input type="checkbox"/> Other (Forest Service, BLM, etc.)
BIOLOGIST CONTACT: DATE OF CONTACT: REVEG. SPECIALIST CONTACT:	Gary Grunder April 21, 2009 Monica Finn – May 5, 2009

ADJACENCY TO BILLBOARDS:
 Project area is adjacent to outdoor advertising. Project area is not adjacent to outdoor advertising.

WATER AND POWER AVAILABILITY: N/A

IS THERE (E) IRRIGATION THAT WILL BE IMPACTED BY THIS PROJECT: Yes No

DESIGN FOR MAINTENANCE SAFETY:

CONTEXT SENSITIVITY:
 It is determined that the project will involve consideration of highway aesthetics and will require further evaluations pertaining to specific roadside enhancements.
 No foreseen issues with highway aesthetics Other Consideration should be given to the railing type to be aesthetically pleasing.

COOPERATIVE MAINTENANCE AGREEMENTS:

Project may involve additional tasks indicated	<input type="checkbox"/> Visual Simulation <input type="checkbox"/> Highway Planting <input type="checkbox"/> Contour Grading	<input checked="" type="checkbox"/> Erosion Control <input type="checkbox"/> Field Visit <input checked="" type="checkbox"/> Cost Estimate	<input type="checkbox"/> SWPPP/NPDES <input type="checkbox"/> Context Sensitive Solutions/Aesthetics <input type="checkbox"/> Landscape Evaluation
--	---	--	--



**NORTH REGION
LANDSCAPE ARCHITECTURE ASSESSMENT SHEET**
03-LAND-0002 (Rev. 3/03)

COST INFORMATION: <input type="checkbox"/> Highway Planting, Irrigation, and/or Mitigation <input type="checkbox"/> ___-year Plant Establishment <input checked="" type="checkbox"/> Erosion Control <input checked="" type="checkbox"/> Slope Protection <input type="checkbox"/> Aesthetic Treatment	 \$35,000 \$ 7,000 TOTAL \$42,000
--	---

OTHER RELATED INFORMATION:

Landscape Architecture Resource Estimate:

ROADSIDE VEGETATION MANAGEMENT TREATMENT NEEDS:

- Extended Gore Areas
- Guardrails and Signs
- Medians
- Road Edge
- Side Slopes/Embankment Slopes

(See: <http://www.dot.ca.gov/hq/LandArch/roadside/index.htm> for potential treatment measures)

The above cost is based on treatment covering an area of 14,520 sq. ft. The landscape treatments for this disturbed area shall consist of:

- Erosion Control Netting; and
- Erosion Control Type D.

The staging area of 108,900 sq. ft. will need to be treated with:

- Erosion Control type D.

PREPARED BY:  DATE: 8/6/09 CONCURRED BY: _____ DATE: _____
 (Project Manager)

APPROVED BY: _____ DATE: _____
 (Landscape Architecture or Engineering Services Branch Chief)

ATTACHMENT I

COST ESTIMATE BREAKDOWN

PRELIMINARY COST ESTIMATE SUMMARY
Alternative 1

PROJECT DESCRIPTION:

**In El Dorado County at South Fork American River Bridge.
Perform seismic retrofit and barrier railing upgrade.**

SUMMARY OF PROJECT COST ESTIMATE

TOTAL ROADWAY ITEMS	\$ 1,062,000
TOTAL STRUCTURE ITEMS	\$ 640,000
SUBTOTAL CONSTRUCTION COSTS	\$ 1,702,000
TOTAL RIGHT OF WAY ITEMS	\$ 485,000
TOTAL PROJECT CAPITAL OUTLAY COSTS	\$ 2,187,000

Reviewed by District
Program Manager

Signature

Date

Approved by
Project Manager

Signature

Date

I. ROADWAY ITEMS

Quantity Unit Unit Price Item Cost Section Cost

Section 1: Earthwork

Roadway Excavation			\$ -	\$ -
Imported Borrow			\$ -	\$ -
Clearing & Grubbing	1	LS	\$ 10,000	\$ 10,000

Subtotal Earthwork \$ 10,000

Section 2: Pavement Structural Section*

PCC Pavement			\$ -	\$ -
HMA (Type A)	38	TON	\$ 244	\$ 9,272
RHMA (Open Graded)	38	TON	\$ 83	\$ 3,187
Cold Plane Asphalt Concrete Pavement	533	SQYD	\$ 8	\$ 4,131
Concrete Barrier (Type 732)			\$ -	\$ -
Treated Permeable Base			\$ -	\$ -
Aggregate Subbase			\$ -	\$ -
Edge Drains			\$ -	\$ -

Subtotal Pavement Structural Sections \$ 16,590

Section 3: Drainage

Large Drainage Facilities			\$ -	\$ -
Storm Drains			\$ -	\$ -
Pumping Plants			\$ -	\$ -
Project Drainage			\$ -	\$ -
Misc Drainage			\$ -	\$ -

Subtotal Drainage \$ -

Quantity Unit Unit Price Item Cost Section Cost

Section 4: Specialty Items

Prepare SWPPP			\$ -	\$ -
Water Pollution Control	1	LS	\$ 10,000	\$ 10,000
Barriers and Guardrails	1	LS	\$ 12,000	\$ 12,000
Irrigation Modification			\$ -	\$ -
Concrete Headlight Glare Screen r&r			\$ -	\$ -
Facilities - Temp Fence & Gate	1	LS	\$ 2,000	\$ 2,000
Erosion Control & Slope Protection	1	LS	\$ 42,000	\$ 42,000
Construction Site BMPs	1	LS	\$ 40,000	\$ 40,000
Resident Engineer Office Space	1	LS	\$ 10,000	\$ 10,000
Additional Funds for Barrier Railing	1	LS	\$ 160,000	\$ 160,000

Subtotal Specialty Items \$ 276,000

Section 5: Traffic Items

Portable Changeable Message Signs	70	Days	\$ 500	\$ 35,000
Roadside Signs (Const Area)	1	LS	\$ 7,000	\$ 7,000
COZEEP	35	Days	\$ 2,000	\$ 70,000
Traffic Control System	70	Days	\$ 1,800	\$ 126,000
Maintain Traffic	70	Days	\$ 500	\$ 35,000
Temporary Signing and Striping	1	LS	\$ 4,000	\$ 4,000
Temporary Railing Type K	1140	LF	\$ 43	\$ 49,020
Temporary Crash Cushion	28	EA	\$ 340	\$ 9,520
Temporary Lighting & Electrical	1	LS	\$ 50,000	\$ 50,000

Subtotal Traffic Items \$ 385,540

SUBTOTAL SECTIONS 1 THROUGH 5 \$ 689,000

Section 6: Minor

Section Cost

$$\boxed{\$ 689,000} \times \boxed{0.1} = \boxed{\$ 68,900}$$

(Subtotal Sections 1-5)

Total Minor Items $\boxed{\$ 69,000}$

Section 7: Roadway Mobilization

$$\boxed{\$ 758,000} \times \boxed{0.10} = \boxed{\$ 75,800}$$

(Subtotal Sections 1-6)

Total Roadway Mobilization $\boxed{\$ 76,000}$

Section 8: Roadway Additions

Supplemental Work

$$\boxed{\$ 758,000} \times \boxed{0.05} = \boxed{\$ 37,900}$$

(Subtotal Sections 1-6)

Contingencies

$$\boxed{\$ 758,000} \times \boxed{0.25} = \boxed{\$ 189,500}$$

(Subtotal Sections 1-6)

Total Roadway Additions $\boxed{\$ 228,000}$

TOTAL ROADWAY ITEMS $\boxed{\$ 1,062,000}$
(Subtotal Sections 1-8)

Estimate Prepared By: Ferdinand Batatan
(Print Name)

Date: 8/24/2009
Phone: (530) 741-5704

Estimate Checked By: Molly Richard
(Print Name)

Date: 8/31/2009
Phone: (530) 741-5746

II. Structures Items

	<i>Quantity</i>	<i>Unit</i>	<i>Unit Price</i>	<i>Item Cost</i>	<i>Section Cost</i>
S Fork American River Bridge #25-0021	1	LS	\$640,000	\$640,000	
Structure Type	Steel Girder				
Footing Type (pile/spread)	Pile				
(includes 10% mobilization and 25% contingency)					

Subtotal Structures Items \$640,000

III. Railroad Related Costs

	<i>Quantity</i>	<i>Unit</i>	<i>Unit Price</i>	<i>Item Cost</i>	<i>Section Cost</i>
N/A			\$ -	\$ -	
			\$ -	\$ -	
			\$ -	\$ -	
			\$ -	\$ -	

Subtotal Railroad Costs \$ -

TOTAL STRUCTURES AND RAILROAD ITEMS \$ 640,000

Estimate Prepared By: Gudmund Setberg
 (Print Name)

Date: 3/10/2009
 Phone: (916) 227-8282

IV. Right of Way Escalated Value

	<i>Item Cost</i>
Acquisition (including excess lands, damages to remainder(s) and goodwill)	\$ 471,628
Project Development Permit Fees	\$ 13,712
Utility Relocation (State share)	\$ -
Relocation Assistance	\$ -
Clearance/Demolition	\$ -
Title and Escrow Fees	\$ -

TOTAL RIGHT OF WAY ITEMS **\$ 485,000**

Anticipated Date of Right of Way Certification November 1, 2013
(Date to which values are escalated)

Construction Contract Work:

Brief Description of Work:

Right of Way Branch Cost Estimate for Work*

* This dollar amount is to be included in the Roadway and/or Structures items of work, as appropriate. Do not include in Right of Way items.

Estimate Prepared By: Kelly Kilpatrick
(Print Name)

Date: 12/31/2010
Phone: (530) 740-4915

ATTACHMENT J

PROGRAMMING SHEET

PROGRAMMING SHEET - 2009/2010

EA: 03-0310 Project Manager: Clark Pen Date: 01/11/2010
 Proj Name: No Nick Co-Rte-PM: ED-049- 024.0/ Type: SHOPP

PROJECT SCHEDULE

MILESTONE		DATE (STATUS)
Begin Environmental Document	M020	08/01/2010 (T)
Begin Project Report	M040	07/01/2010 (T)
Circulate Environmental Document (DED)	M120	01/15/2012 (T)
Project Approval & Environmental Document (PA&ED)	M200	11/01/2012 (T)
District Submits Bridge Site Data to Structures	M221	11/01/2011 (T)
Right of Way Maps	M224	09/01/2011 (T)
Regular Right of Way	M225	03/01/2012 (T)
District Plans, Specifications & Estimates to DOE	M377	04/01/2013 (T)
Draft Structures Plans, Specifications & Estimates	M378	03/01/2013 (T)
District Plans, Specifications & Estimates (PS&E)	M380	07/01/2013 (T)
Right of Way Certification	M410	11/01/2013 (T)
Ready to List (RTL)	M460	11/01/2013 (T)
Headquarters Advertise (HQ AD)	M480	01/16/2014 (T)
Approve Construction Contract	M500	05/04/2014 (T)
Contract Acceptance (CCA)	M600	05/04/2015 (T)
End Project	M800	05/03/2017 (T)

ESTIMATE	DATE	AMOUNT
ROADWAY	01/07/10	\$ 1062
BRIDGE	01/07/10	\$ 640
Subtotal Const		\$ 1702
RIGHT OF WAY	01/06/10	\$ 485
MITIGATION		\$ 0
Subtotal RW		\$ 485
GRAND TOTAL		\$ 2187

EXISTING PROGRAMMING	
PAED	\$
PS&E	\$
RW - Sup	\$
RW - Cap	\$
Const - Sup	\$
Const - Cap	\$

*Does not apply to RW Capital + Not Escalated ++ Only Escalated to 1 year into Future

PROJECT COSTS BY SB45 CATEGORY

CAPITAL COST ESTIMATE (Escalation Factor)	Prior Yrs+	09/10+	10/11 (3.5%)	11/12 (3.5%)	12/13 (3.5%)	13/14 (3.5%)	Future++ (3.5%)	Total	
Right of Way						485		\$ 485	
Construction						1953		\$ 1,953	
CAPITAL COSTS TOTAL								\$ 2,438	
SUPPORT COSTS (Escalation Factor)			(1.5%)	(1.5%)	(1.5%)	(1.5%)	(1.5%)		Sup/Cap
PAED		5	151	143	47			\$ 345	14.17%
PS&E			34	183	276	54		\$ 547	22.45%
Right of Way				10	0	2	9	\$ 21	0.87%
Construction						52	333	\$ 385	15.78%
SUPPORT COSTS TOTAL								\$ 1,299	53.27%
TOTAL PROJECT COSTS								\$ 3,737	

PROJECT SUPPORT IN PYS

	Prior Yrs	09/10	10/11	11/12	12/13	13/14	Future	Total	PY %
Environmental	0.00	0.01	0.73	0.77	0.55	0.02	0.04	2.12	25.63%
Design	0.00	0.00	0.19	0.25	0.21	0.00	0.03	0.68	8.22%
Engineering Services	0.00	0.00	0.15	0.32	0.38	0.03	0.07	0.95	11.49%
Surveys	0.00	0.00	0.02	0.07	0.01	0.02	0.08	0.20	2.42%
Right of Way	0.00	0.00	0.01	0.00	0.01	0.00	0.01	0.03	0.36%
Traffic	0.00	0.00	0.04	0.12	0.12	0.03	0.07	0.38	4.59%
Construction	0.00	0.00	0.00	0.03	0.09	0.17	0.93	1.22	14.75%
Project Management	0.00	0.01	0.08	0.10	0.06	0.04	0.14	0.43	5.20%
District Units*	0.00	0.00	0.03	0.03	0.03	0.01	0.05	0.15	1.81%
Subtotal Dist/Region Resources	0.00	0.02	1.25	1.69	1.46	0.32	1.42	6.16	74.49%
59-DES Project Development	0.00	0.00	0.01	0.41	0.48	0.04	0.10	1.04	12.58%
59-DES Structures Foundation	0.00	0.00	0.00	0.00	0.00	0.00	0.00	0.00	0.00%
59-Office Engineer	0.00	0.00	0.00	0.03	0.03	0.19	0.00	0.25	3.02%
59-DES Project Management	0.00	0.00	0.01	0.02	0.01	0.00	0.00	0.04	0.48%
59-DES Construction	0.00	0.00	0.01	0.02	0.04	0.11	0.60	0.78	9.43%
59-DES Other Units**	0.00	0.00	0.00	0.00	0.00	0.00	0.00	0.00	0.00%
Subtotal DES Resources	0.00	0.00	0.03	0.48	0.56	0.34	0.70	2.11	25.51%
TOTAL PYs	0.00	0.02	1.28	2.17	2.02	0.66	2.12	8.27	

*Admin, Png, Maintenance
 **DES Admin, DES Png, DES Maintenance
 HRS/PYS = 1758
 Comments: