

File No. PA16-0006

Location Map

Town Center West Residential
Pre-Application



117-160-48, -49, -50, -51, portion of -46 and -47



Exhibit A

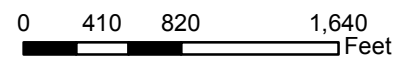

POR. SEC. 11, T.9N., R.8E., M.D.M.

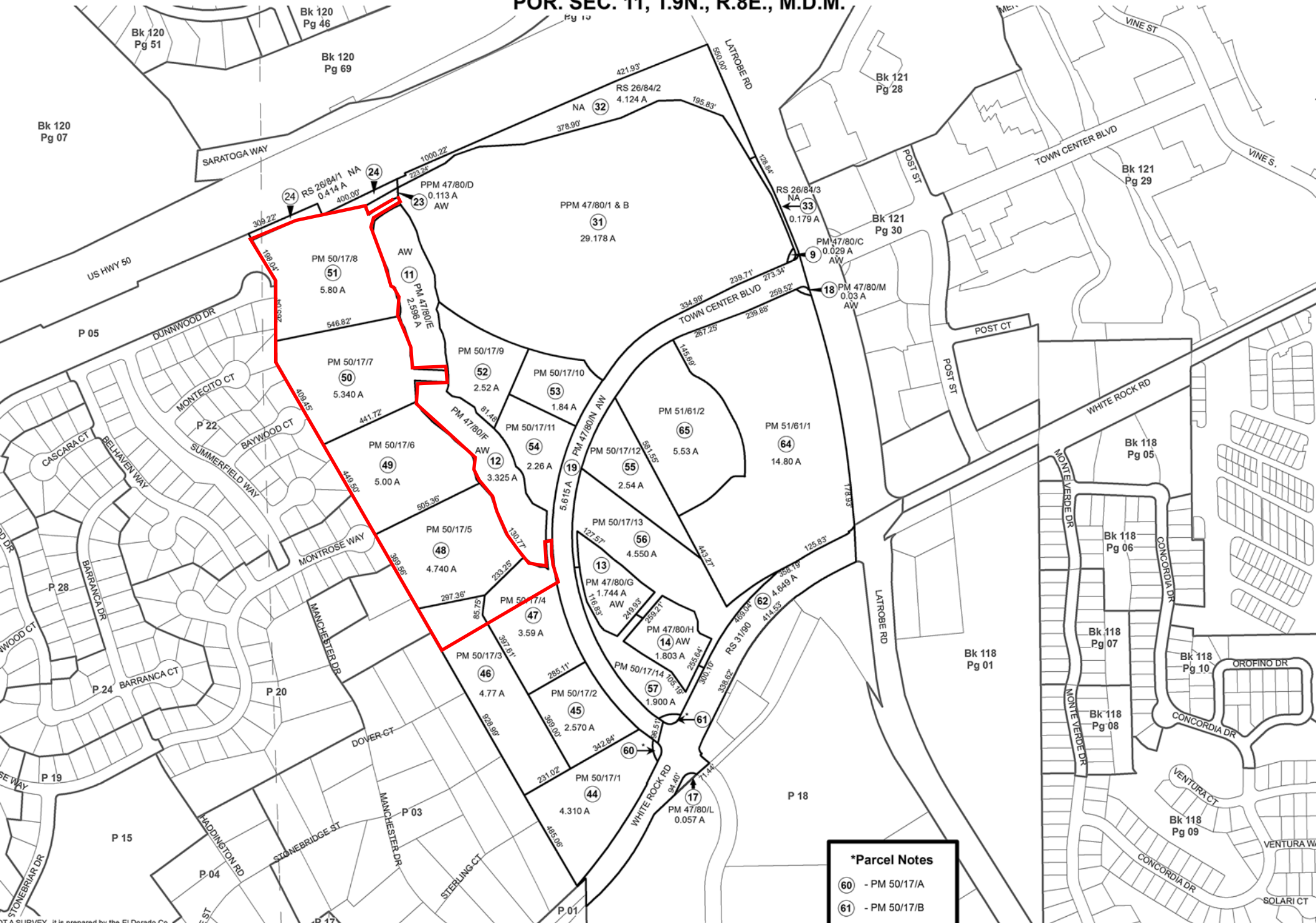

Bk 120 Pg 07

Bk 120 Pg 51

Bk 120 Pg 46

Bk 120 Pg 69

Bk 121 Pg 28

Bk 121 Pg 29

Bk 121 Pg 30

Bk 118 Pg 05

Bk 118 Pg 06

Bk 118 Pg 07

Bk 118 Pg 08

Bk 118 Pg 09

Bk 118 Pg 10

Bk 118 Pg 01

***Parcel Notes**
 (60) - PM 50/17/A
 (61) - PM 50/17/B

...T A SURVEY, it is prepared by the El Dorado Co. for assessment purposes only. Area calculations are not guaranteed. Users should verify items and acreage.

Acreages Are Estimates

Adjacent Map Pages Shown in Grey Text
 Assessor's Block Numbers Shown in Ellipses
 Assessor's Parcel Numbers Shown in Circles

Exhibit B

Rev. OCT 31, 2014
 17-0070 B 2 of 80

Assessor's Map
 County of El

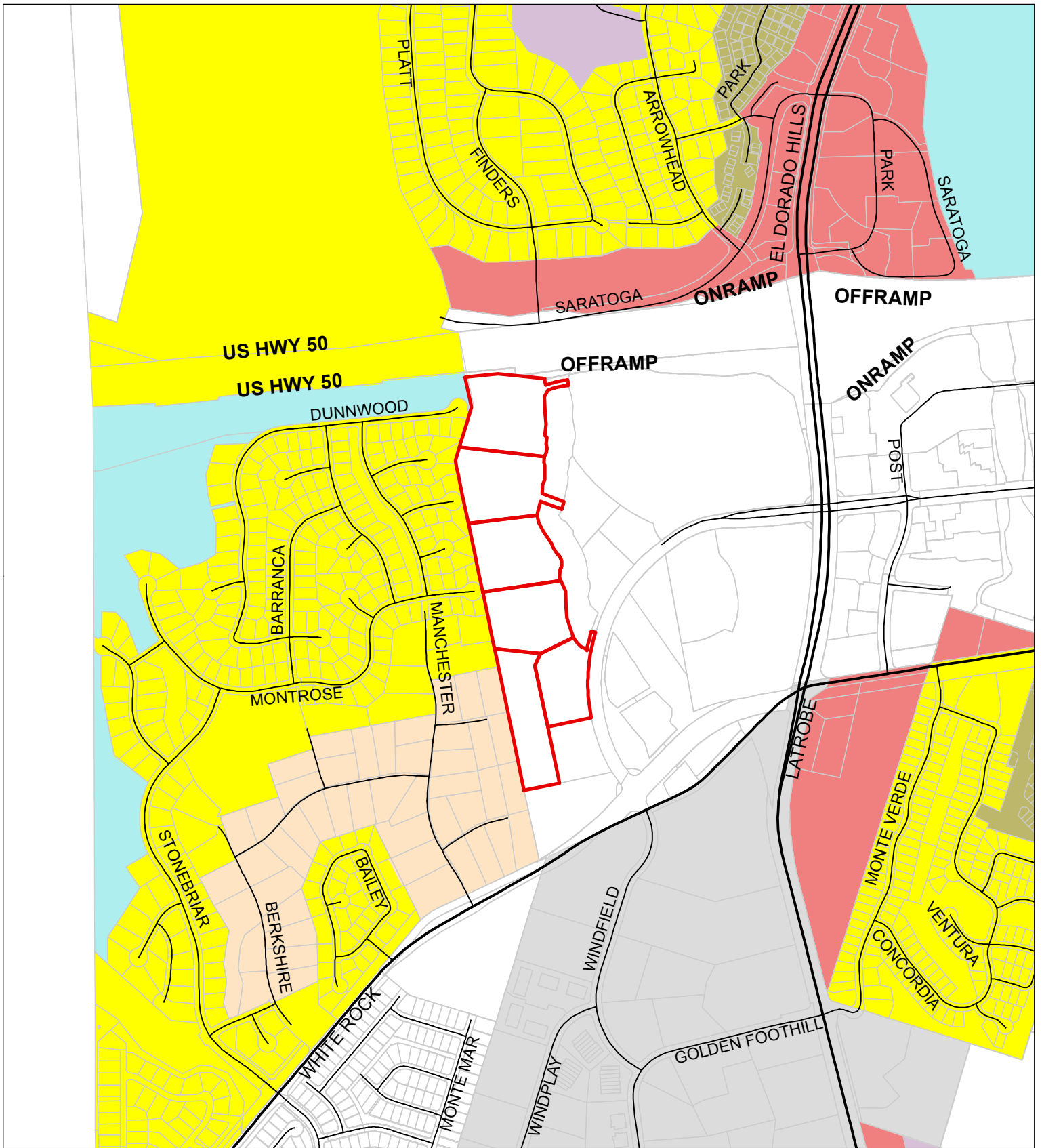

File No. PA16-0006
Land Use Map

Town Center West Residential
 Pre-Application

- Site
- Adopted Plan
- Commercial
- High Density Residential
- Medium Density Residential
- Research & Development
- Multi-Family Residential
- Open Space
- Public Facilities

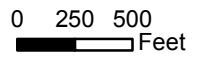
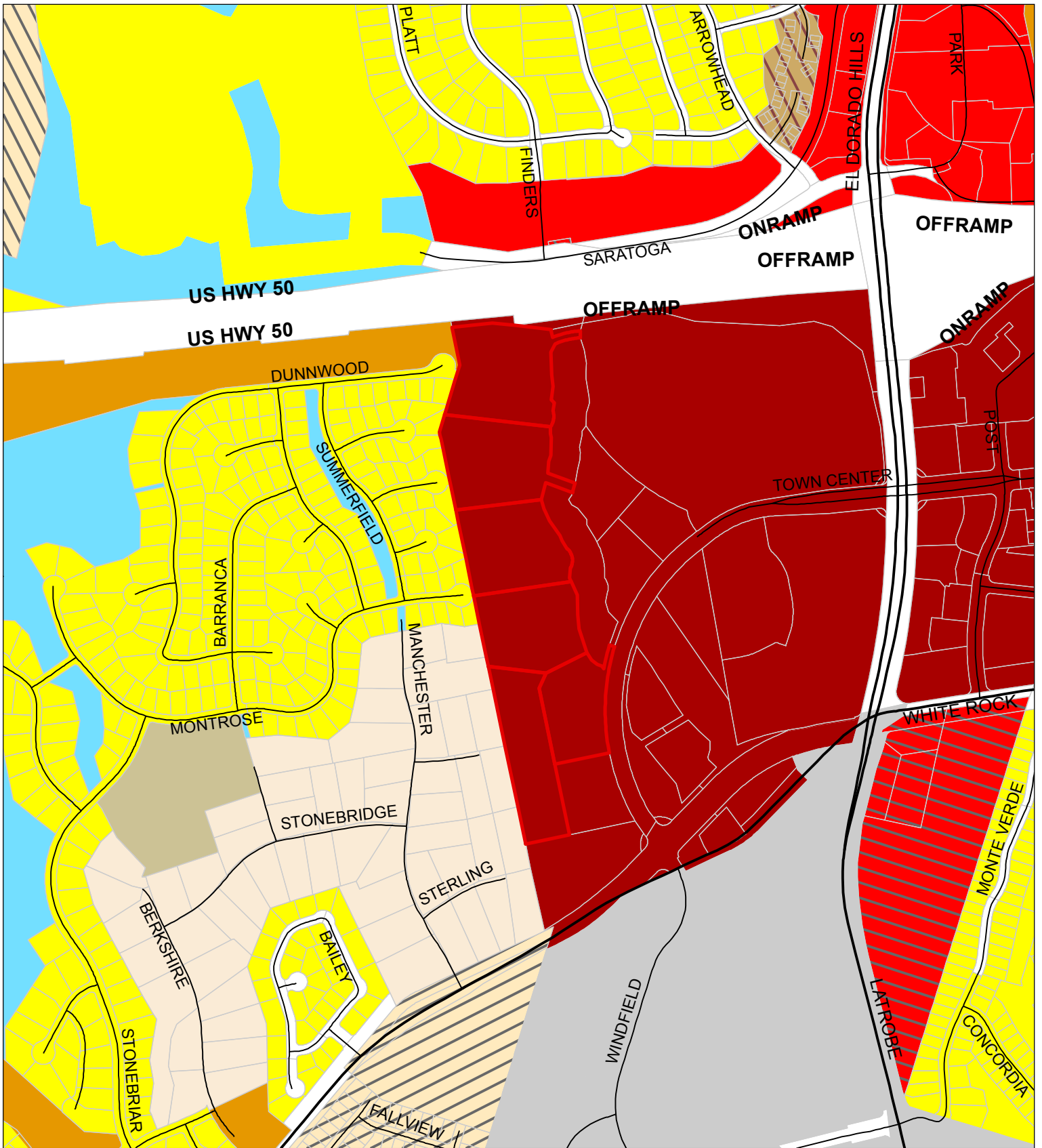

Exhibit C



**File No. PA16-0006
Zoning Map**

**Town Center West Residential
Pre-Application**

- Site
- CC = Commercial Community
- CG = Commercial General
- CL = Commercial Limited
- CR = Commercial Regional
- OS = Open Space
- R&D = Reasearch & Development
- R1 = Residential Single Unit

- RM = Residential Multi-Unit
- R20K = Residential 20,000
- R1A = Residential 1 Acre
- RF-H = Recreational Facility High
- CC-SP = Carson Creek Specific Plan
- PR-SP = Promontory Specific Plan
- TC = Transportation Corridor

0 250 500
Feet



Exhibit D



TOWN CENTER EAST & WEST

SEPTEMBER, 2016

16 NOV 22 AM 8:26

RECEIVED
PLANNING DEPARTMENT

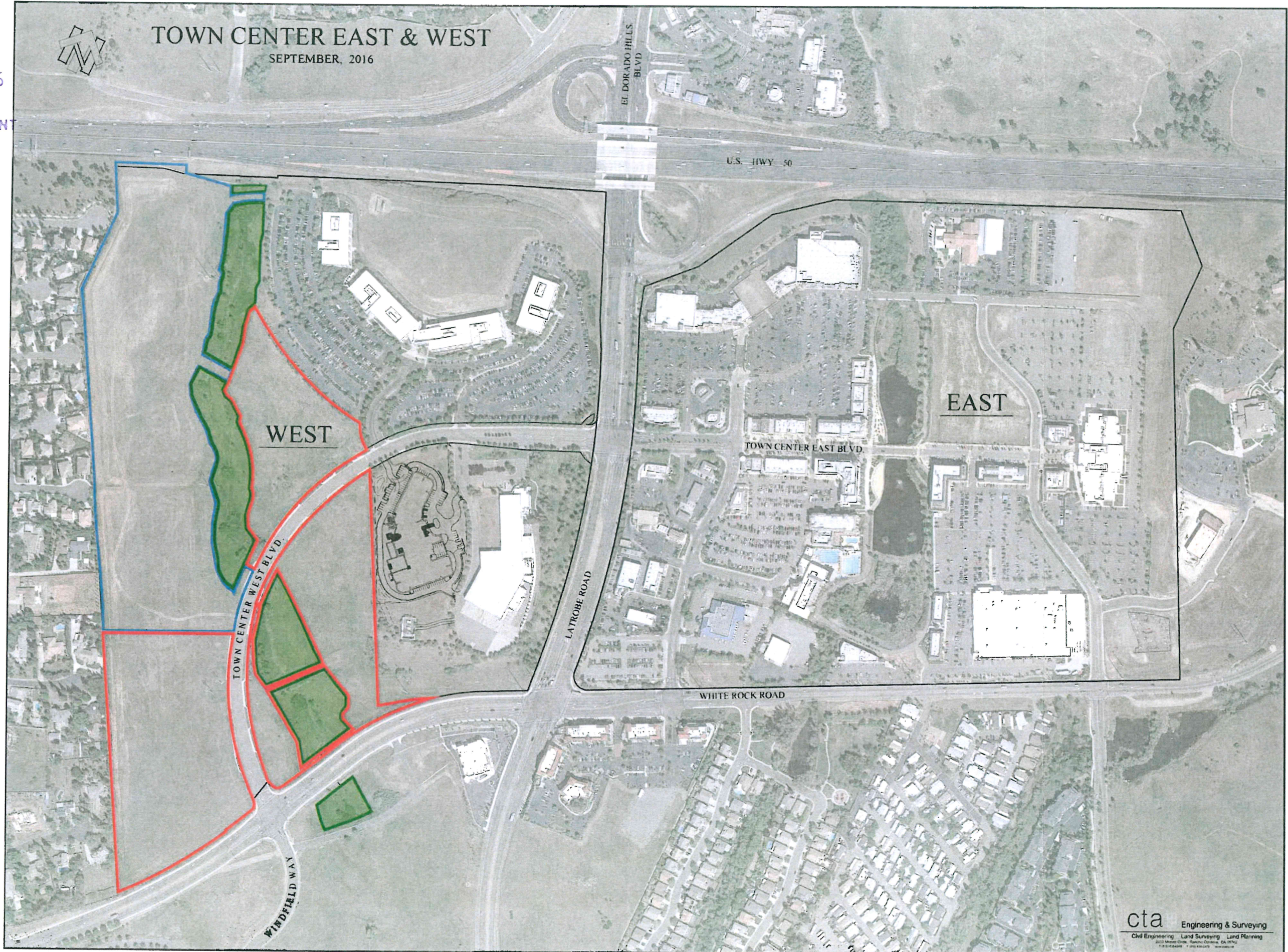

Exhibit E

TOWN CENTER WEST

SEPTEMBER, 2016



16 NOV 22 AM 8:26
RECEIVED
PLANNING DEPARTMENT

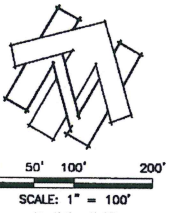

TOWN CENTER WEST PLANNING AREA D

EL DORADO COUNTY, CALIFORNIA
SCALE: 1"=100' SEPTEMBER, 2016

16 NOV 22 AM 8:26
RECEIVED
PLANNING DEPARTMENT

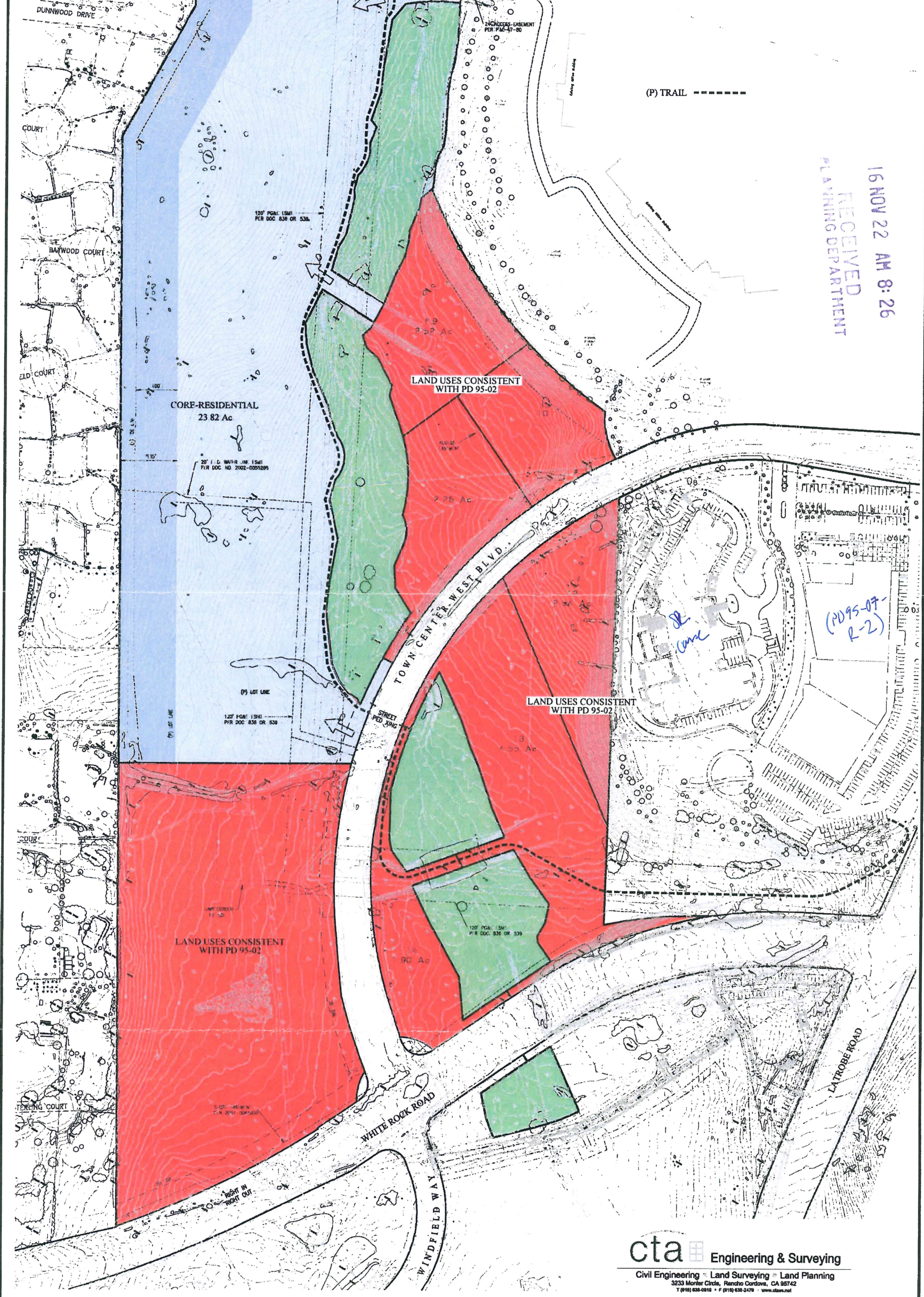

cta Engineering & Surveying
Civil Engineering • Land Surveying • Land Planning
3233 Monier Circle, Rancho Cordova, CA 95742
TEL: 916-838-0918 • FAX: 916-838-2078 • www.cta.com

**EL DORADO HILLS
TOWN CENTER**

**DESIGN GUIDELINES
and
DEVELOPMENT STANDARDS**

TOWN CENTER WEST

Approved
April 27, 1995
El Dorado County Planning Commission

Approved
May 9, 1995 (Development Plan)
May 23, 1995 (Master Signage Program)
El Dorado County Board of Supervisors

Prepared by:
THE MANSOUR COMPANY
1241 Hawks Flight Court, Suite 205
El Dorado Hills, California 95762
(916) 933-3013

Planning and Architectural Consultant:
MURRAY & DOWNS AIA Architects, Inc.
3025 Sacramento Street
Placerville, California 95667
(916) 626-1810

Signage Consultant:
DAVIES ASSOCIATES
9424 Dayton Way, Suite 217
Beverly Hills, California 90210
(310) 247-9572

Landscape Consultant:
CAPITAL DESIGN GROUP
1913 Capitol Avenue, Suite B
Sacramento, California 95814
(916) 973-0283

TABLE OF CONTENTS

Exhibit F

Purpose

The purpose of these Design Guidelines is to direct the orderly development of the El Dorado Hills Town Center consistent with the goals and policies of the El Dorado Hills Specific Plan. These Design Guidelines reflect those presented in the Specific Plan while providing additional development criteria to encourage innovative design and creative expression in meeting the needs and demands of the community.

It is intended that these Design Guidelines allow for the creation of a character at the Town Center appropriate to and in keeping with that of El Dorado County, its landscape and its historic building types. The intention is not to dictate a style of building but rather to encourage, within the context of modern materials and methods, an architectural style expressive of the simple forms found in the historic buildings of the area.

Introduction

In adopting the nearly 4,000 acre El Dorado Hills Specific Plan, the County of El Dorado approved a commercial site along U.S. Highway 50 at the El Dorado Hills Boulevard/Latrobe interchange designated in the Specific Plan as Villages T and U. Now known as the **El Dorado Hills Town Center**, these villages were **"intended to provide for commercial uses of greater variety and at a higher intensity than provided elsewhere in the Specific Plan area or in the greater El Dorado Hills/Cameron Park area."** The site is zoned General Commercial - Planned Development and the zoning is secured by a Development Agreement between the property owner and the County of El Dorado. The Town Center ultimately can be expected to be the **"hub of economic development in western El Dorado County"** and **"a major node of economic and retail activity on the eastern side of the Sacramento Metropolitan region."**

The Land Use element of the Specific Plan recognizes the pivotal role of the Town Center in the overall scheme of the community and refers to the area as the **"major commercial area."** Use of the broad category CG - General Commercial zoning enables the Town Center to respond to rapidly re-defining and evolving markets and to take advantage of the demands of new technologies for quality business settings within a well-planned and definitively regulated environment. The use of the Planned Development Overlay Zone provides the County a "level of review" to ensure consistency with the Design Guidelines and Standards set forth within the Specific Plan.

The Town Center consists of two distinct yet complimentary components - **Town Center East** and **Town Center West**. Retail and service commercial uses are concentrated within **Town Center East**. It is here that highway commercial uses are sited so as to achieve a high degree of visibility from U.S. Highway 50 while neighborhood and community uses are located in areas of convenient access and within the Town Square - the heart of Town Center East. Larger, more regionally oriented uses are accommodated within the Major Retail area and can be accessed from both Latrobe and White Rock Roads. **Town Center West** is planned as an employment center of mid- and low-rise buildings within five planning areas. Ancillary uses which could be accommodated include a conference hotel facility and support retail services.

Uses stated and depicted within the Specific Plan for **Town Center West** included hotel/convention center, restaurants, medical facilities, highway commercial, office parks, retail, business, professional and research development. The Specific Plan explicitly states that the types of uses to be allowed at Town Center West "include but are not necessarily limited to" those listed. Uses allowed within the CG - General Commercial zoning include a wide variety of "sales, storage, distribution and light manufacturing businesses of the type which do not ordinarily cause more than a minimal amount of noise, odor, smoke, dust or other factors tending to disturb the peaceful enjoyment of adjacent residential or agricultural land uses" (El Dorado County Code Chapter 17.32.170). Light manufacturing is also allowed in the C - Commercial land use category under the 1981 El Dorado County Long Range Plan in effect at the time of adoption of the Specific Plan and the Development Agreement for Town Center West in 1989.

TOWN CENTER WEST

Town Center West consists of approximately 130 acres along U.S. Highway 50 at the El Dorado Hills Boulevard/Latrobe interchange. Access to Town Center West is provided from Latrobe Road via Town Center Boulevard, a landscape enhanced, divided parkway, and from White Rock Road at D Street. Limited and/or restricted driveway access from White Rock Road may also be provided. Pedestrian and bicycle access is provided by means of sidewalks and bicycle lanes within the right-of-way for both Latrobe and White Rock Roads.

The **Town Center West** Planned Development provides for an employment center of five planning areas briefly described below and summarized in Figure 1.

Planning Area A is located in the southeast quadrant of Town Center West with access provided by Town Center Boulevard. Planning Area A consists of approximately 36 acres. Planned building square footage is 477,000 square feet.

Planning Area B is located in the in the northwest quadrant of the Town Center West adjacent to U.S. Highway 50 with access provided by D Street. Planning Area B consists of approximately 30 acres. Planned building square footage is 347,000 square feet.

Planning Area C is located in the northeast quadrant of Town Center West with access provided by Town Center Boulevard. Planning Area C consists of approximately 24 acres. Planned building square footage is 237,000 square feet.

Planning Area D is located along the eastern boundary of Town Center West with access provided by D Street. Planning Area D consists of approximately 23 acres. Planned building square footage is 344,000 square feet.

Planning Area E is located at the southern boundary of Town Center West and is separated from the northern planning areas by White Rock Road. Access is provided by driveways from White Rock Road and Latrobe Road. Planning Area E consists of approximately 7 acres. Planned building square footage is 60,000 square feet.

Figure 1: Planning Areas and Planned Building Square Footage

	Area Acreage	Planned Building Square Footage
Planning Area A	36.3	477.000
Planning Area B	29.7	347.000
Planning Area C	24.4	237.000
Planning Area D	22.7	344.000
Planning Area E	7.1	60.000
Roads	10.9	
Totals	131.1	1,465.000

1. The Land Uses

Proposed by the Town Center West Planned Development are those uses consistent with the El Dorado Hills Specific Plan and the CG - General Commercial zoning granted at the time of adoption of the Specific Plan and the approval of the Development Agreement vesting the development rights. While the uses described below are intended to create a quality environment of complementary and compatible uses, it is recognized that not all appropriate and viable uses can be "listed" at any given time. Within the regulatory framework of the Design Guidelines and Development Standards, additional uses may from time to time be found to be consistent with the intent and purpose of the Town Center West Planned Development. Types of uses proposed are described below and tabulated in Figure 2.

1.1 "LM" - Uses of a light manufacturing and assembling nature including the warehousing and distribution of such goods when fully enclosed within the building and of a type which do not ordinarily cause more than a minimal amount of dust, smoke, odor, air or water pollutants, noise or electrical interference or other factors tending to disturb the peaceful enjoyment of the adjacent residential use will be permitted in those Planning Areas having the LM designation. Permitted uses include:

Data Processing Technologies	Plastics Molding Processes and Assembly
Digital Information Components Assembly and Manufacturing	Precision Instruments Assembly and Manufacturing
Electronics Component Assembly and Manufacturing	Printing and Publishing Plants

Ancillary and support uses such as restaurants and retail sales may be approved from time to time

in accordance with the regulatory framework of the Design Guidelines and Development Standards.

1.2 "RD" - Uses of a service, research or product development nature when fully enclosed within the building of a type which do not ordinarily cause more than a minimal amount of dust, smoke, odor, air or water pollutants, noise or electrical interference or other factors tending to disturb the peaceful enjoyment of the adjacent residential use and which cannot be accommodated within traditional office buildings will be permitted in those Planning Areas having the RD designation. Also permitted are uses of a light manufacturing nature which may generate a greater number of trip ends than those assumed for areas designated LM. Permitted uses include:

- | | |
|--|--|
| Blueprint Services | Information Systems Research |
| Computer Technologies | Laboratories - scientific, research and testing |
| Data Processing | Materials Research |
| Digital Information Transfer Processes | Photocopying and Printing Services |
| Electronics Component Assembly and Manufacturing | Precision Instruments Assembly and Manufacturing |

Ancillary and support uses such as restaurants and retail sales may be approved from time to time in accordance with the regulatory framework of the Design Guidelines and Development Standards.

1.3 "BPO" - Uses of a business and professional nature which can be accommodated within traditional office settings including administrative and governmental offices and corporate offices of businesses not otherwise allowed within the Town Center West Planned Development such as construction and engineering firms will be permitted in those Planning Areas having the BPO designation. These uses shall provide a transition and buffer zone between the adjacent residential use and the more intense uses within the Town Center West Planned Development. Permitted uses include:

- | | | |
|------------|-----------------------|---------------------------|
| Accountant | Financial Brokerage | Land Planner |
| Architect | Financial Institution | Medical/Dental |
| Attorney | Graphic Designer | Professional Associations |
| Engineer | Investment Brokerage | Surveyor |

Ancillary and support uses such as restaurants and retail sales may be approved from time to time in accordance with the regulatory framework of the Design Guidelines and Development Standards.

1.4 "C" - Uses of a service and retail nature will be limited to those which are ancillary to

and in support of the primary uses within the development and will not exceed 60,000 square feet in total. Permitted uses include:

Barber Shop	Fast Food Restaurant	Office Supplies
Boxing/Shipping Service	Florist	Restaurant
Copy/Printing Service	Hair Salon	Service Station
Delicatessen	Hotel	Shoe Repair
Dry Cleaner	Newsstand	Stationers

Figure 2: Planned Square Footage by Use and Planning Area

	LM	RD	BPO	C	Total
Planning Area A	250,000	200,000	27,000	10,000 ¹	477,000
Planning Area B	300,000	47,000			347,000
Planning Area C			237,000	250rm Hotel	237,000
Planning Area D		150,000	194,000	15,000 ¹	344,000
Planning Area E				35,000 ¹	60,000 ¹
Total	550,000	397,000	458,000	60,000¹	1,465,000

Note 1. The total Planned Square Footage of Category C use shall not exceed 60,000 square feet. When allocated to a Planning Area other than Planning Area E, the number of square feet of Category C uses allocated shall be deducted from Category BPO.

1.5 Uses Not Specified

Additional uses may be permitted when, by determination of the Director of Planning, such uses are found to be similar in nature to those established within the Town Center West Planned Development. Should the Director of Planning be unable to make such a determination, the Applicant may request the Planning Commission make a finding permitting such use based on the information requested and submitted through the Planned Development Site Plan process and, by resolution of record, set forth its findings and its interpretations.

1.6 Planned Square Footage

The Total Planned Square Footage for any Planning Area is shown in Figure 2. Total Planned Square Footage, whether by Use or Planning Area, may be exceeded provided any project proposing such adheres to all other development standards of the Town Center West Planned Development and the impacts of such a proposed project do not preclude the development of the Planned Square Footage of the remaining Uses or Planning Areas as determined by the Director of Planning. Should the Director of Planning be unable to make such a determination, the

Applicant may request the Planning Commission make a finding permitting such use based on the information requested and submitted through the Planned Development Site Plan process and, by resolution of record, set forth its findings and its interpretations.

1.7 Allocation of Uses

Upon request of any project proponent, the Director of Planning may determine, based on the information requested and submitted through the Planned Development Site Plan Process, that a re-allocation of uses within or between any Planning Area(s) is appropriate. In no event shall the Allowed Square Footage of Category C uses exceed 60,000 square feet. See Figure 2. Should the Director of Planning be unable to make such a determination, the Applicant may request the Planning Commission make a finding permitting such use based on the information requested and submitted through the Planned Development Site Plan process and, by resolution of record, set forth its findings and its interpretations.

1.8 Approval Process

Site specific project approvals shall be a ministerial act of the Director of Planning. Prior to submitting a building permit application to the County, site specific projects shall be approved by the Design Review Committee as defined in the Covenants, Conditions and Restrictions for the El Dorado Hills Town Center West. Prior to issuance of a building permit, County staff shall find the proposed site specific project has received approval from the Design Review Committee and is consistent with the Development Plan, the Development Standards and other conditions of approval of the Town Center West Planned Development.

2. The Development Standards

(Refer to the Improvements Phasing Plan for Planning sub-Areas.)

2.1 Planning Area A

2.1.1 Building Height - Buildings situated in Planning sub-Area A1 and A2 shall be limited to 35 feet in height whereas buildings in Planning sub-Area A3 shall have a maximum height of 65 feet.

2.1.2 Minimum Front Setbacks - shall be applicable to all lots having frontage on any public or private street adjacent to and within Town Center West. See Appendix 1 - Street Cross Section criteria.

2.1.2 Minimum Front Setbacks - (continued)

	Building		Parking	
	from ROW	from toe/top of slope	from ROW	from toe/top of slope
Latrobe Road	50'	30'	25'	5'
White Rock Road	50'	30'	15'	5'
Town Center Boulevard	35'	30'	15'	5'
D Street	35'	30'	10'	5'
Private Streets	35'	30'	10'	5'

2.1.3 Minimum Side lot and Rear lot Setbacks - When not abutting a public or private street, side lot setback shall be 5 feet and rear lot setback shall be 10 feet except that for every building or portion of a building of which an exterior wall of the first floor is located more than 150 feet from a fire access roadway as measured by an approved route around the exterior of the building a fire access roadway shall be provided. Side lot and rear lot setback may be zero (0) feet subject to a firewall approved by the County of El Dorado Building Department and upon approval of the El Dorado Hills Fire Department. Where side and/or rear lot abuts a public or private street, setback shall be those as for Front Setbacks above.

2.1.4 Drainage Corridor - A 100 foot (50 feet each side of centerline) non-building corridor shall be maintained along the intermittent drainage which bisects the Planning Area. The corridor shall be maintained as a landscape feature and as an integral component of the engineered drainage system. The corridor may be crossed for purposes of driveways and parking lot circulation.

2.1.5 PG&E Easement - A 120 foot PG&E easement bisects the Planning Area. Uses within the easement are limited to roadways, driveways, parking and landscape and are subject to approval by PG&E.

2.2 Planning Area B

2.2.1 Building Height - Buildings situated along the western boundary adjacent to existing residential zoning shall be limited in height to 35 feet. Buildings situated east of the drainage corridor shall have a maximum height of 65 feet.

2.2.2 Minimum Front Setbacks - shall be applicable to all lots having frontage on any public or private street adjacent to and within Town Center West. See Appendix 1 -

Street Cross Section criteria.

2.2.2 Minimum Front Setbacks - (continued)

	Building		Parking	
	from ROW	from toe/top of slope	from ROW	from toe/top of slope
Town Center Boulevard	35'	30'	15'	5'
U.S. Highway 50	50'	30'	20'	5'
Private Streets	35'	30'	10'	5'
West Boundary Landscape Buffer	60' [from property line]	30'	20' [from property line]	5'

2.2.3 Minimum Side lot and Rear lot Setbacks - When not abutting a public or private street, side lot setback shall be 5 feet and rear lot setback shall be 10 feet except that for every building or portion of a building of which an exterior wall of the first floor is located more than 150 feet from a fire access roadway as measured by an approved route around the exterior of the building a fire access roadway shall be provided. Side lot and rear lot setback may be zero (0) feet subject to a firewall approved by the County of El Dorado Building Department and upon approval of the El Dorado Hills Fire Department. Where side and/or rear lot abuts a public or private street, setback shall be those as for Front Setbacks above.

2.2.4 Drainage Corridor - A 100 foot (50 feet each side of centerline) non-building corridor shall be maintained along the intermittent drainage which bisects the Planning Area. The corridor shall be maintained as a landscape feature and as an integral component of the engineered drainage system. The corridor may be crossed for purposes of driveways and parking lot circulation.

2.2.5 PG&E Easement - A 120 foot PG&E easement bisects the Planning Area. Uses within the easement are limited to roadways, driveways, parking and landscape and are subject to approval by PG&E.

2.2.6 Landscape Buffer - A landscape buffer shall be provided along the western boundary of Planning Area B adjacent to the neighboring residential project. The landscape buffer shall be 20 feet in width where the adjacent residential project is required to provide a 10 foot buffer and 30 feet in width where no buffer is required of the adjacent residential project. The landscape buffer shall incorporate elements of height such as berms and hedges and may include decorative and security fencing.

2.2.7 Acoustical Analysis - Exterior noise levels at any project property line common with residential development shall be no greater than 55 dB Ldn. Consistent with El Dorado Hills Specific Plan Policy 1.4.1.4, developers of projects adjacent to residential

development shall submit an acoustical analysis prepared by a qualified acoustical consultant prior to issuance of a building permit. The analysis shall include mitigations required to meet the above 55 dB Ldn standard relating to such project elements as site development and building placement, truck loading and delivery area design and landscape features including natural topographic barriers.

2.3 Planning Area C

2.3.1 Building Height - Buildings situated along Latrobe Road shall be limited in height to 50 feet. Buildings situated on the prominent hillside shall be sited so as to conform to the contour of the hillside and shall not exceed 35 feet in height.

2.3.2 Minimum Front Setbacks - shall be applicable to all lots having frontage on any public or private street adjacent to and within Town Center West. See Appendix 1 - Street Cross Section criteria.

	Building		Parking	
	from ROW	from toe/top of slope	from ROW	from toe/top of slope
Latrobe Road	50'	30'	25'	5'
Town Center Boulevard	35'	30'	15'	5'
U.S. Highway 50	50'	30'	20'	5'
Private Streets	35'	30'	10'	5'

2.3.3 Minimum Side lot and Rear lot Setbacks - When not abutting a public or private street, side lot setback shall be 5 feet and rear lot setback shall be 10 feet except that for every building or portion of a building of which an exterior wall of the first floor is located more than 150 feet from a fire access roadway as measured by an approved route around the exterior of the building a fire access roadway shall be provided. Side lot and rear lot setback may be zero (0) feet subject to a firewall approved by the County of El Dorado Building Department and upon approval of the El Dorado Hills Fire Department. Where side and/or rear lot abuts a public or private street, setback shall be those as for Front Setbacks above.

2.4 Planning Area D

2.4.1 Building Height - Buildings shall be limited in height to 35 feet.

2.4.2 Minimum Front Setbacks - shall be applicable to all lots having frontage on any public or private street adjacent to and within Town Center West. See Appendix 1 - Street Cross Section criteria.

2.4.2 Minimum Front Setbacks - (continued)

	Building		Parking	
	from ROW	from toe/top of slope	from ROW	from toe/top of slope
Town Center Boulevard	35'	30'	15'	5'
D Street	35'	30'	10'	5'
White Rock Road	50'	30'	15'	5'
Private Streets	35'	30'	10'	5'
West Boundary Landscape Buffer	60' [from property line]	30'	30' [from property line]	5'

2.4.3 Minimum Side lot and Rear lot Setbacks - When not abutting a public or private street, side lot setback shall be 5 feet and rear lot setback shall be 10 feet except that for every building or portion of a building of which an exterior wall of the first floor is located more than 150 feet from a fire access roadway as measured by an approved route around the exterior of the building a fire access roadway shall be provided. Side lot and rear lot setback may be zero (0) feet subject to a firewall approved by the County of El Dorado Building Department and upon approval of the El Dorado Hills Fire Department. Where side and/or rear lot abuts a public or private street, setback shall be those as for Front Setbacks above.

2.4.4 Drainage Corridor - A 100 foot (50 feet each side of centerline) non-building corridor shall be maintained along the intermittent drainage at the eastern boundary of the Planning Area. The corridor shall be maintained as a landscape feature and as an integral component of the engineered drainage system. The corridor may be crossed for purposes of driveways and parking lot circulation.

2.4.5 PG&E Easement - A 120 foot PG&E easement bisects the Planning Area. Uses within the easement are limited to roadways, driveways, parking and landscape and are subject to approval by PG&E.

2.4.6 Landscape Corridor - A landscape buffer shall be provided along the western boundary of Planning Area D adjacent to the neighboring residential project. The landscape buffer shall be 20 feet in width where the adjacent residential project is required to provide a 10 foot buffer and 30 feet in width where no buffer is required of the adjacent residential project. The landscape buffer shall incorporate elements of height such as berms and hedges and may include decorative and security fencing.

2.4.7 Acoustical Analysis - Exterior noise levels at any project property line common

with residential development shall be no greater than 55 dB Ldn. Consistent with El Dorado Hills Specific Plan Policy 1.4.1.4, developers of projects adjacent to residential development shall submit an acoustical analysis prepared by a qualified acoustical consultant prior to issuance of a building permit. The analysis shall include mitigations required to meet the above 55 dB Ldn standard relating to such project elements as site development and building placement, truck loading and delivery area design and landscape features including natural topographic barriers.

2.4.8 Emergency Access Easement - *(Bob, How do we describe this? Recorded against parcel prior to transfer of title? at time of PD approval? when alignment is determined by either development of TCW or Springfield Ranch?)*

2.5 Planning Area E

2.5.1 Building Height - Buildings shall be limited in height to 35 feet.

2.5.2 Minimum Front Setbacks - shall be applicable to all lots having frontage on any public or private street adjacent to and within Town Center West. See Appendix 1 - Street Cross Section criteria.

	Building		Parking	
	from ROW	from toe/top of slope	from ROW	from toe/top of slope
Latrobe Road	50'	30'	10'	5'
D Street	35'	30'	10'	5'
White Rock Road	50'	30'	15'	5'
Private Streets	35'	30'	10'	5'

2.5.3 Minimum Side lot and Rear lot Setbacks - When not abutting a public or private street, side lot setback shall be 5 feet and rear lot setback shall be 10 feet except that for every building or portion of a building of which an exterior wall of the first floor is located more than 150 feet from a fire access roadway as measured by an approved route around the exterior of the building a fire access roadway shall be provided. Side lot and rear lot setback may be zero (0) feet subject to a firewall approved by the County of El Dorado Building Department and upon approval of the El Dorado Hills Fire Department. Where side and/or rear lot abuts a public or private street, setback shall be those as for Front Setbacks above.

2.5.4 Drainage Corridor - A 100 foot (50 feet each side of centerline) non-building corridor shall be maintained along the intermittent drainage at the eastern boundary of the Planning Area. The corridor shall be maintained as a landscape feature and as an integral component of the engineered drainage system. The corridor may be crossed for purposes

of driveways and parking lot circulation.

- 2.6 **Maximum Impervious Surface** - within any project site shall not exceed 75% of site area net of Drainage Corridor, PG&E Easement, Landscape Corridor and slope banks.
- 2.7 **Minimum Lot Area** - shall be 15,000 square feet.
- 2.8 **Minimum Lot Width** - shall be 150 feet measured at the setback line from each public or private street on which the lot has frontage.

3. The Design Guidelines

In keeping with the Commercial Design Guidelines presented in the Specific Plan, it is intended that Town Center West "create an aesthetically pleasing environment" while providing for "commercial uses of a greater variety and at a higher intensity" than elsewhere in the El Dorado Hills community or the County west slope area. The following Design Guidelines are intended to foster consistency, compatibility and continuity throughout Town Center West.

Note: Throughout this document, italics are used to present statements, policies and guidelines expressed in the EL Dorado Hills Specific Plan.

3.1 Circulation

The circulation system at Town Center West is designed in concert with that of Town Center East. The intersection of Town Center Boulevard with Latrobe Road shall be signalized with multiple turn lanes to facilitate traffic movements to and from the Centers. Vehicular circulation will be served from an internal street system rather than directly from surrounding arterials. Street cross sections shall conform to the Development Plan. See Appendix 1 - Street Cross Section Criteria. Sidewalks shall be located within all public street rights-of-way and shall be enhanced with shade trees and other landscape materials. See Appendix 3 - Specific Landscape Criteria. Bicycle lanes within public street rights-of-way shall link Town Center West with the surrounding community.

- 3.1.1 Primary access to Town Center West shall occur at Latrobe Road via Town Center Boulevard, a landscaped enhanced, divided parkway. Except as follows, no other access shall be allowed onto Latrobe Road from any adjacent parcel unless such access is approved by the Director of the Department of Transportation:
 - a. One driveway, limited to right turn in and right turn out only, on the west side of Latrobe Road a minimum of 350 feet south of White Rock Road.

This access restriction shall be shown on all parcel maps.

- 3.1.2 Secondary access to Town Center West shall occur at White Rock Road via D Street.

Except as follows, no other access shall be allowed onto Latrobe Road from any adjacent parcel unless such access is approved by the Director of the Department of Transportation:

- a. One driveway, limited to right turn in and right turn out only, on the north side of White Rock Road west of D Street near the project's western boundary line.
- b. One driveway, limited to right turn in and right turn out only, on the south side of White Rock Road midway between Latrobe Road and D Street.

These access restrictions shall be shown on all parcel maps.

- 3.1.3 No access shall be allowed onto Town Center Boulevard from adjacent parcels other than as shown on the approved Development Plan unless such access is approved by the Director of the Department of Transportation.
- 3.1.4 D Street shall extend from its terminus in the north with Town Center Boulevard to the southernmost boundary line of the project property whether or not White Rock Road is realigned or improved within its present alignment.
- 3.1.5 Provision shall be made for public transportation services as required by a Trip Reduction Ordinance or other public transportation regulation. This may take the form of bus or van pull-outs at designated locations, passenger waiting facilities and/or alternative vehicle parking and/or storage facilities. In these instances, *all street furniture (bus shelters, benches, trash receptacles, etc.) shall utilize a common design theme as provided for in the Design Guidelines. See Appendix 2 - Approved Hardscape Elements.*
- 3.1.6 Parking and loading spaces shall conform to Chapter 17.18 of the El Dorado County Zoning as to size and number. Requests for reduction in the number of spaces required shall be accompanied by supporting analyses and may be made to the Director of Planning or the Planning Commission.
- 3.1.7 *Common access drives shall be used where feasible to minimize the number of driveways occurring along internal streets and shall be adequately sized to accommodate anticipated traffic.*
- 3.1.8 *The dimensions of all driveways and aisles shall be adequate to serve the number and design requirements of the parking spaces provided, and shall be in conformance with County standards where no stated or depicted Town Center West Design Guideline standard is established.*
- 3.1.9 *Pedestrian and auto circulation shall be separated. Separations may take the form of buffer plantings, grade changes, or the provision of additional distance between these circulation systems.*

- 3.1.10 Sidewalks and bicycle lanes shall be located on both sides of all internal and peripheral public streets. See Appendix 1 - Street Cross Section Criteria.
- 3.1.11 *Trees shall be planted along all streets to provide shade, to soften the appearance of the hard streetscape, and to create a tree canopy to enhance pedestrian comfort.* See Appendix 1 - Street Cross Section Criteria and Appendix 3 - Specific Landscape Criteria.
- 3.1.12 *Pedestrian paths and walkways should be designed to prevent pedestrian access through planted areas.*
- 3.1.13 *All pedestrian pathways shall be paved and at a minimum of 4 feet in width. All sidewalks that combine bicycle and pedestrian use shall be a minimum of 6 feet in width.* Walkways adjacent to public streets shall be the minimum width indicated on the appropriate street cross section. See Appendix 1 - Street Cross Section Criteria.
- 3.1.14 *The use of paving materials such as stamped concrete, interlocking pavers, exposed aggregate, and other embellished paving materials is recommended in areas of high pedestrian activity.*
- 3.1.15 *Selected crosswalks within each development shall be delineated with one of the paving materials listed above and shall contrast with the pavement of the street, alley, driveway, or parking lot in which the crosswalk occurs.* See Appendix 2 - Approved Hardscape Elements and Exhibit B - Town Center West Landscape Concept.

3.2 Architectural Character

The overall architectural character at Town Center West is derived from the historical buildings of El Dorado County. The simple, utilitarian form and economy of means necessary in an earlier time will be expressed through the use of modern materials and contemporary ideas in architecture. Within the limitations of the needs of the users within Town Center West for facilities of functional and economical design, the same structural clarity and invention of those earlier days will be encouraged at Town Center West today.

- 3.2.1 Buildings shall have substance and durability both in reality and appearance. Stucco, concrete, block, brick and wood siding shall be the standard. Brick, stone, heavy timbers and materials replicating and reflecting these and the natural surroundings shall be used as both functional and ornamental components.
- 3.2.2 Architectural massing shall be simple and regular. The bulk of large buildings shall be minimized by changes in color and texture, wall scoring, plant-on detailing, changes of roof plane, shifts in the facade and other architectural means.
- 3.2.3 The height, scale and texture of buildings shall respond to the surroundings so that Town Center West is continuously knitted together.

- 3.2.4 Rootlines shall be integrated with the overall design of the building. Roof elements shall conceal roof-top mechanical equipment and be incorporated so as to be perceived as unified with the building mass.
- 3.2.5 Roof covering materials shall be reflective of the European influence prevalent in Northern California. Wood shakes and shingles, concrete and architectural grade composition roof coverings imitative of wood shakes and shingles, slate tiles and metal channeled roofing materials shall be the standard for all accent and decorative roof areas. The red clay tiles of the Spanish influence in Southern California are not acceptable.
- 3.2.6 Light to medium valued colors shall be used on the exterior of buildings, especially as their height increases.
- 3.2.7 Glass shall be used carefully with special attention paid to color, opening sizes, frame color and material, and changes of plane between glass and other exterior materials. Reflective glass is prohibited.
- 3.2.8 Building signage shall conform to the Town Center Master Signage Program. See Appendix 5 - Master Signage Program - Town Center West.
- 3.2.9 Plazas, courtyards and parking lots shall be defined on at least two sides by buildings or landscaping. Facades, arcades, garden walls, trees or other elements having strong visual character shall be used to define such open spaces.
- 3.2.10 Pedestrian areas and sidewalks shall incorporate arcades, colonnades and trellises wherever possible to achieve a greater pedestrian comfort level. In areas where these elements are not appropriate, sidewalks shall be enlivened with awnings, canopies, landscaping or other means to provide full or partial coverings.
- 3.2.11 Works of art are encouraged in the development of major outdoor spaces. The use of pools, sprays, fountains and sculptures and other elements of visual interest such as flags, murals, banners, hangings, sculpture may be incorporated where appropriate.

3.3 Landscape Character

The variety of uses and their intensity within the different planning areas at Town Center West will be unified through a defined landscape character. Landscape will be used to identify entry sequences and individual circulation elements and to reduce the impact of the scale and size of the structures necessary within the employment center. A landscape corridor shall buffer the adjacent residential zoning. Where feasible, the drainage corridor shall be incorporated into the landscape concept and shall provide for pedestrian access. The Design Guidelines provide for a plant species mix which is complementary to the native species and yet compatible with the scope and scale of the development. In addition to the species listed in Appendix 3 - Specific Landscape Criteria, please refer to the El Dorado Hills Specific Plan Appendix B - Plant List Tables.

- 3.3.1 A major landscape and monument sign entry statement shall be located at the intersection of Town Center Boulevard and Latrobe Road. A minor entry statement shall be constructed at D Street and White Rock Road. See Appendix 3 - Specific Landscape Criteria and Appendix 5 - Town Center West Signage Program.
- 3.3.2 Individual user entry treatments shall compliment the landscape and monument entry statements for the overall project. See Appendix 5 - Master Signage Program.
- 3.3.3 All public streets shall have a continuous and consistent softscape and hardscape treatment. *Planting adjacent to streets shall blend with the streetscape planting.* See Appendix 1 - Street Cross Section Criteria and Appendix 3 - Specific Landscape Criteria.
- 3.3.4 Initial tree plantings shall be as indicated in Appendix 3 - Specific Landscape Criteria. Subsequent plantings shall be matched to maturing tree size or 36" box, whichever is smaller.
- 3.3.5 A landscape buffer shall be provided along the western boundary adjacent to the neighboring residential project. The landscape buffer shall vary from 20 to 30 feet in width and may incorporate elements of height such as berms, low hedges and decorative and security fencing. See Appendix 3 - Specific Landscape Criteria.
- 3.3.6 *Trees shall be planted and maintained throughout surfaced parking lots to ensure that, within 15 years after planting, a minimum of 40 percent of the parking lot will be shaded.*
- 3.3.7 *Areas to be planted with turf shall not slope in excess of 3:1. Areas within the public right-of-way that are to be planted with turf shall not slope in excess of 4:1. All areas which are to be planted with ground cover shall not slope in excess of 2:1. All planting areas shall be graded to drain at 2 percent minimum grade.*
- 3.3.8 *Mounding and berming shall be utilized where practical to add topographical variety to the landscape.*
- 3.3.9 *To the maximum extent possible, landscape design shall incorporate native trees and shrubs and should be drought resistant.*
- 3.3.10 *All landscaped areas will be maintained with an automatic irrigation system. Where possible, drip irrigation is recommended.*

3.4 Site Planning Criteria

The site planning criteria are proposed to achieve the project's long-term planning, urban design and marketing goals and to help ensure that individual projects promote the overall circulation and landscape concepts of Town Center West. *Site design shall be accomplished in a manner that will integrate the commercial area with surrounding residential or commercial properties*

through the extensive use of landscaping, plazas, and buildings oriented in a predetermined, cohesive manner.

- 3.4.1 Site planning shall enhance and integrate building architecture, landscape architecture, color and signage through all stages of design.
- 3.4.2 Corner cut-offs and related landscape and monument signage shall provide a strong entry sequence into Town Center West as well as project identification. See Appendix 3 - Specific Landscape Criteria and Appendix 5 - Master Signage Program - Town Center West.
- 3.4.3 Individual projects shall provide a well-articulated, identifiable entry sequence from street to building. Entry into individual sites and connections to and into buildings shall be enhanced with landscaping, hardscape, conforming signage and accented architectural design.
- 3.4.4 *All walls and fences shall be of a design compatible with adjacent architecture. Heights of walls and fences shall be as required for their intended use but shall not exceed 8 feet unless approved by the Design Review Committee.*
- 3.4.5 *Where serving as a visual or noise barrier for enclosure of storage areas, open work areas or refuse collection areas, wall and fence heights and materials shall be sufficient to ensure that adjacent properties and public streets are protected from visual or noise impacts.*
- 3.4.6 *Loading docks and delivery points shall be located away from major vehicular and pedestrian circulation areas, as well as residences and meeting places utilized by the general public. No vehicle loading or unloading shall be permitted on public roads or private shared access roads.*
- 3.4.7 *All loading and storage areas shall be screened from view from streets and the neighboring residences and located at the rear of buildings. For those buildings located adjacent to the neighboring residences, loading and storage areas may be located at the sides of buildings. Screening can be achieved by mounding, plantings, fences, walls, or a combination of these elements.*
- 3.4.8 *Trash enclosures will be required for all trash containers and be consistent with the architectural style. All enclosures shall have gates to facilitate pickup and litter control. All enclosures shall be of adequate height to screen the trash container from view.*
- 3.4.9 *Where trash enclosures can be viewed from a second story level or from adjacent residences, a roof, trellis or other similar screening technique shall be used to screen the trash enclosures from view. Trash compactors within tenant spaces are recommended to minimize the size and number of trash containers.*

- 3.4.10 Antennas or other transmission devices, transformers and electrical equipment whether attached to or separate from the building shall be screened from view from streets and adjacent residences with walls, berms, plant material or full height screens.
- 3.4.11 Overall site grading shall be consistent with the Grading Concept Plan. *Grading may be natural or architectural in form and should complement the architecture or land use of a site in a pleasing manner.* No lot shall be additionally graded so as to alter the flow of surface run-off away from the engineered and constructed storm drain system.
- 3.4.12 Grading cut slopes shall not exceed 40 feet in height and may incorporate a crib or other type of earth/stone retaining wall not exceeding 30 feet in height. Grading fill slopes shall not exceed 40 feet in height with a slope not to exceed 2:1. The resulting manufactured slopes shall be revegetated with approved ground cover plant materials. See Appendix 3 - Specific Landscape Criteria

3.5 Lighting Concept

Exterior lighting at Town Center West shall enhance and reinforce the image of the Center as a quality experience. Consideration shall be given both to the safety of vehicular, bicycle and pedestrian traffic and the affect of ambient light levels in the community. On-site lighting shall provide adequate light for the proper conduct of business while respecting neighboring properties and protecting the surrounding community from the glare and sky glow of spilled light. Accent lighting may be used to feature architectural elements, landscaping, entries and pedestrian areas, provided it is compatible with all other lighting.

- 3.5.1 *Lighting shall include project and building entry lighting, parking lot lighting, pathway lighting, and accent lighting for landscaping and architecture. Security lighting also should be included when necessary.*
- 3.5.2 Lighting intensities shall vary being more intense at entry areas while non-entry areas shall have lower lighting levels.
- 3.5.3 *Lighting fixture design shall be consistent in shape, material and color and shall be compatible with other site elements. See Appendix 2 - Approved Hardscape Elements.*
- 3.5.4 *All exterior lighting fixtures shall be efficient in terms of design and energy use. Low and high-pressure sodium lamps are recommended in public areas but prohibited on structures.*
- 3.5.5 *Lighting fixtures within commercial areas shall be designed to deflect light and glare away from the viewsheds of adjacent residences, parks, and open space areas. Fixture placements are to be approved by the Design Review Committee. Cutoff-type fixtures are preferred to minimize light spillage and glare. Lighting fixtures in parking areas shall be mounted with the light source parallel to the ground.*

- 3.5.6 Flashing lights, strings of lights, search lights, laser light beams and colored lights shall not be permitted. Christmas lighting displays may be permitted upon approval of the Design Review Committee.
- 3.5.7 All exterior architectural lighting shall utilize indirect light sources. Acceptable lighting includes wall washing, overhead down lighting, interior lighting that spills outside and decorative wall-mounted lights that are integral with the building.
- 3.5.8 On-building sign illumination shall coordinate in color and intensity with the building exterior illumination (e.g. internally-illuminated signs should not be washed out by bright building exterior illumination).
- 3.5.9 Wall-mounted security-type service area lighting fixtures may be used only in screened service areas and only when direct light and glare is kept within these areas. Wall-mounted service lighting shall consist of cut-off type fixtures with the light source parallel to the ground and not tilted. Service and security lighting may not be substituted for pedestrian, architectural or parking area lighting along street frontages.
- 3.5.10 Courtyards, arcades and seating areas shall be lighted to promote pedestrian use and safety. A variety of lighting may be used to create interest and special effects in coordination with the character and function of the area.
- 3.5.11 Step or bollard lighting shall be used to clearly illuminate level changes and handrails for stairs and ramps. Bollards also may be used to supplement and enhance other pedestrian area lighting.
- 3.5.12 *All electrical, telephone, and other cable services shall be installed underground. Transformers, terminal boxes, meter cabinets, pedestals, concealed ducts, and other facilities necessary and appurtenant to underground facilities, street lighting, and the irrigation system may be placed above ground when necessary. Public utilities may be provided in private streets with recorded easements to ensure access as required for maintenance.*

Appendix 1 - Street Cross Section Criteria

NOTE:

"A" Street is to be designated "Town-Center Boulevard."

"D" Street is to be designated.

TOWN CENTER

LATROBE ROAD

ULTIMATE - SECTION A

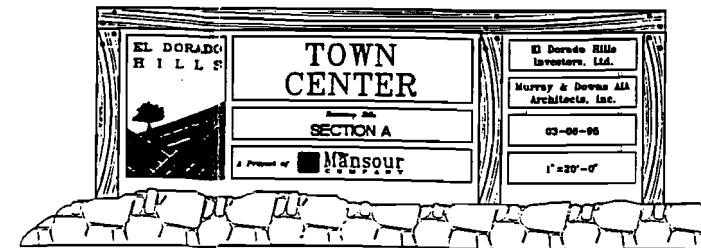
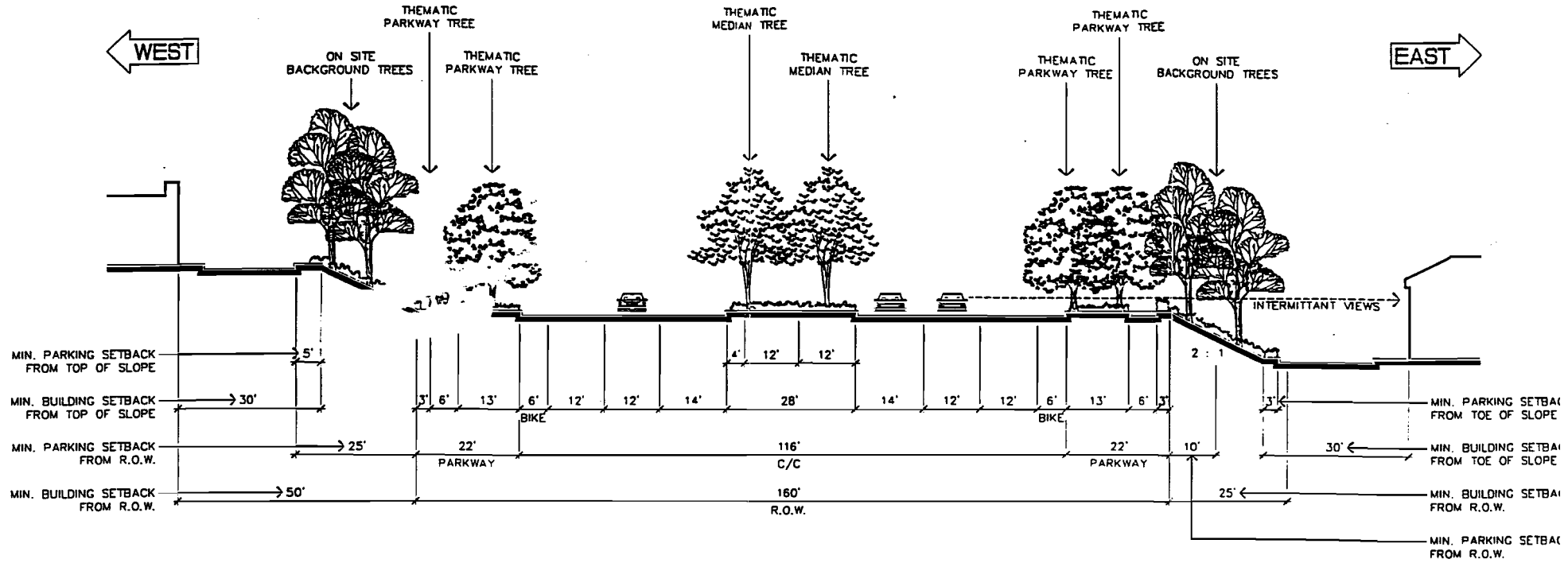

TOWN CENTER

WEST

TOWN CENTER BOULEVARD

ENTRY - SECTION 1

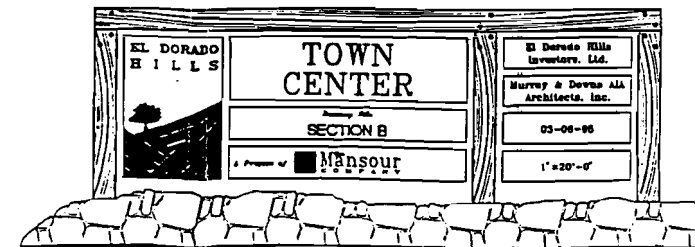
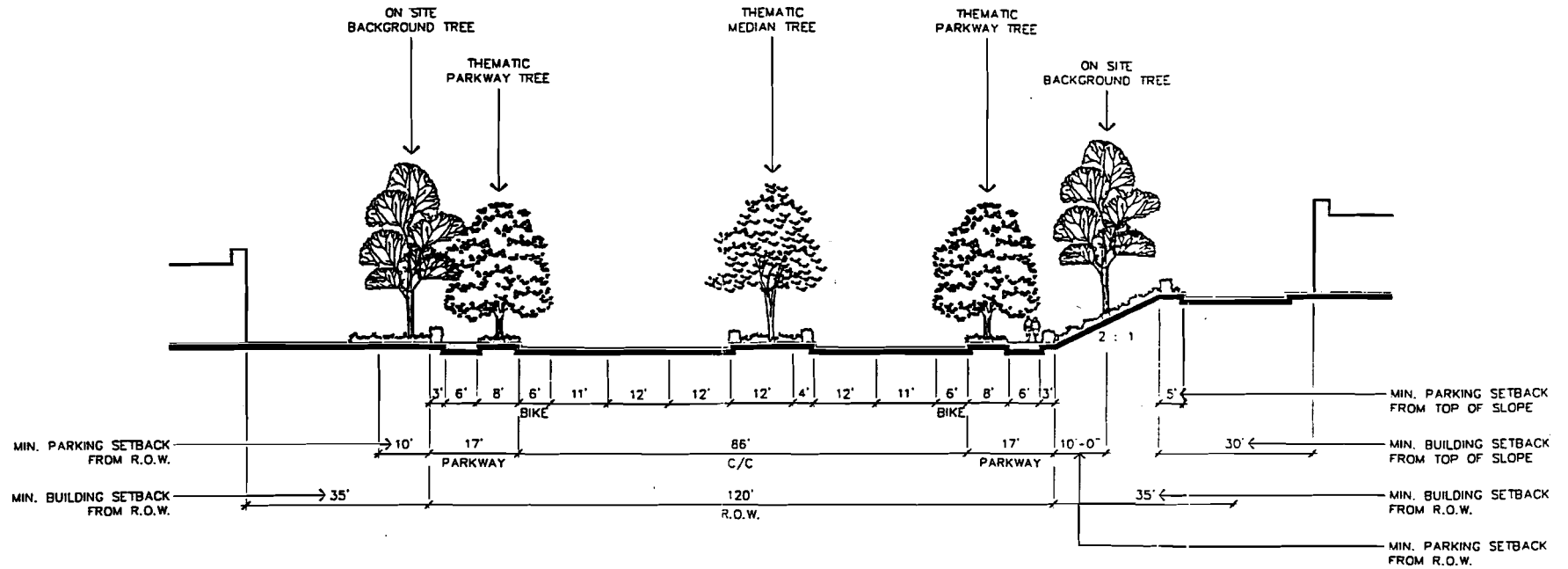

TOWN CENTER

TOWN CENTER BOULEVARD

WEST

SECTION C1

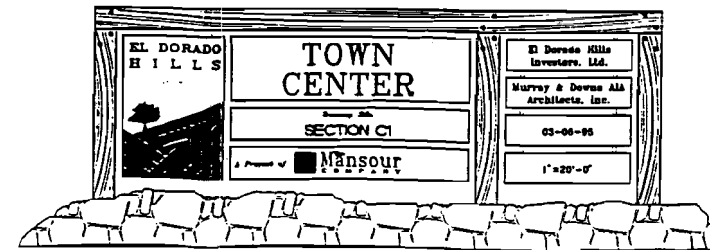
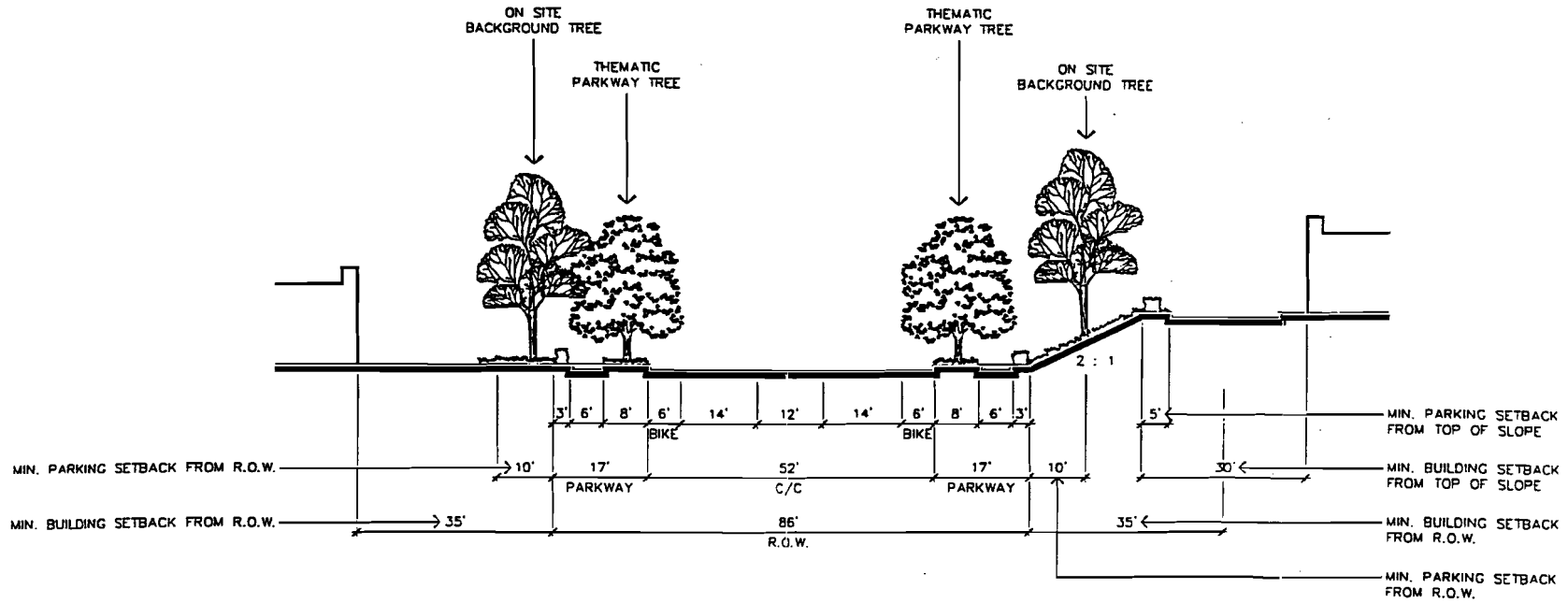

TOWN CENTER

TOWN CENTER BOULEVARD

WEST

SECTION C2

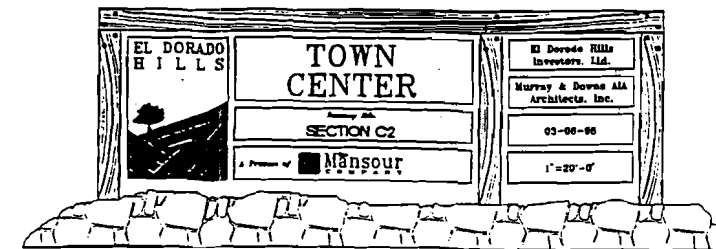
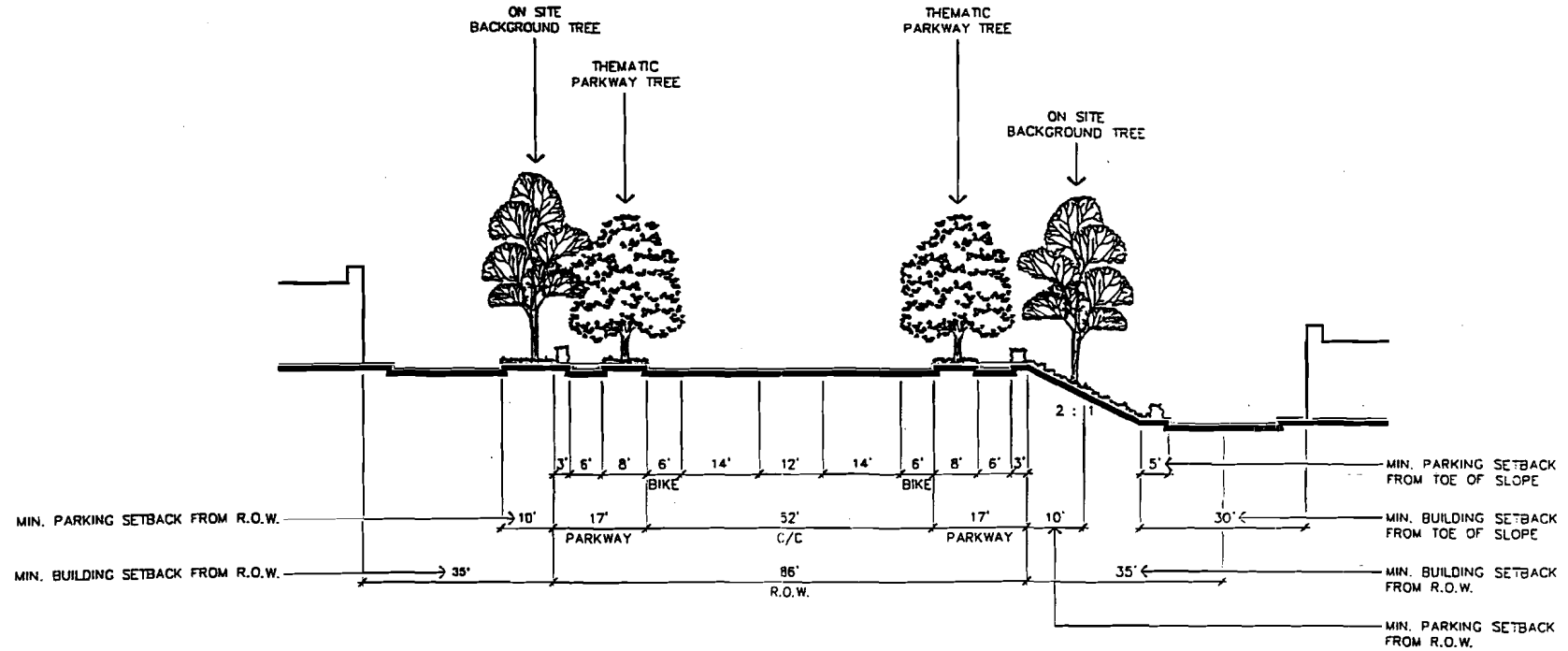

TOWN CENTER

WEST

"D" STREET

ENTRY - SECTION I

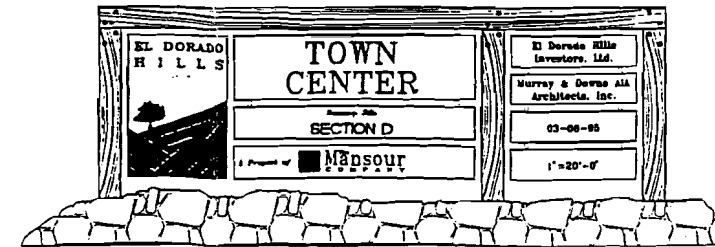
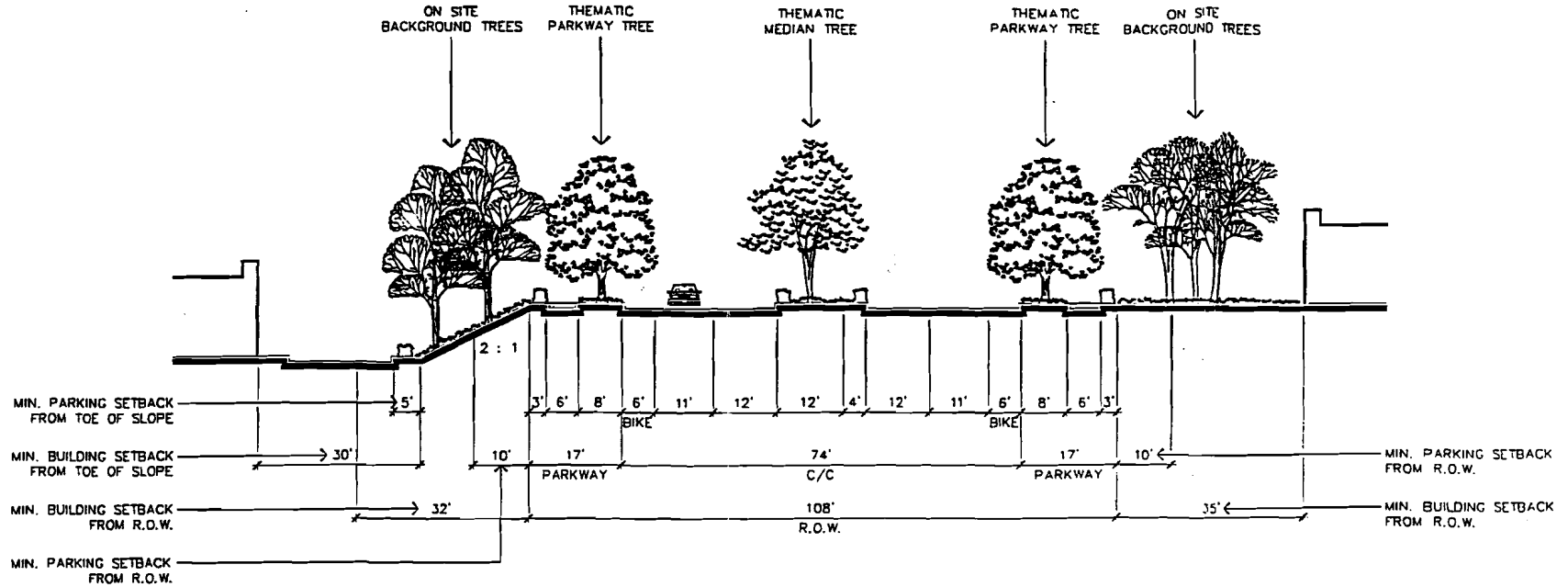

TOWN CENTER

WEST

"D" STREET

SECTION E

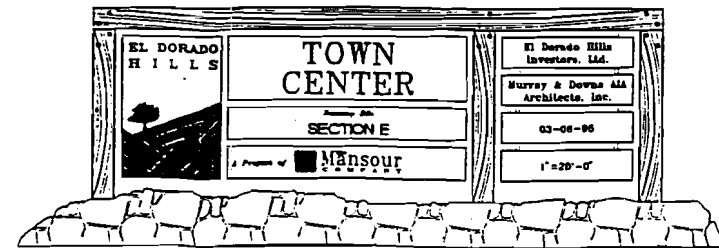
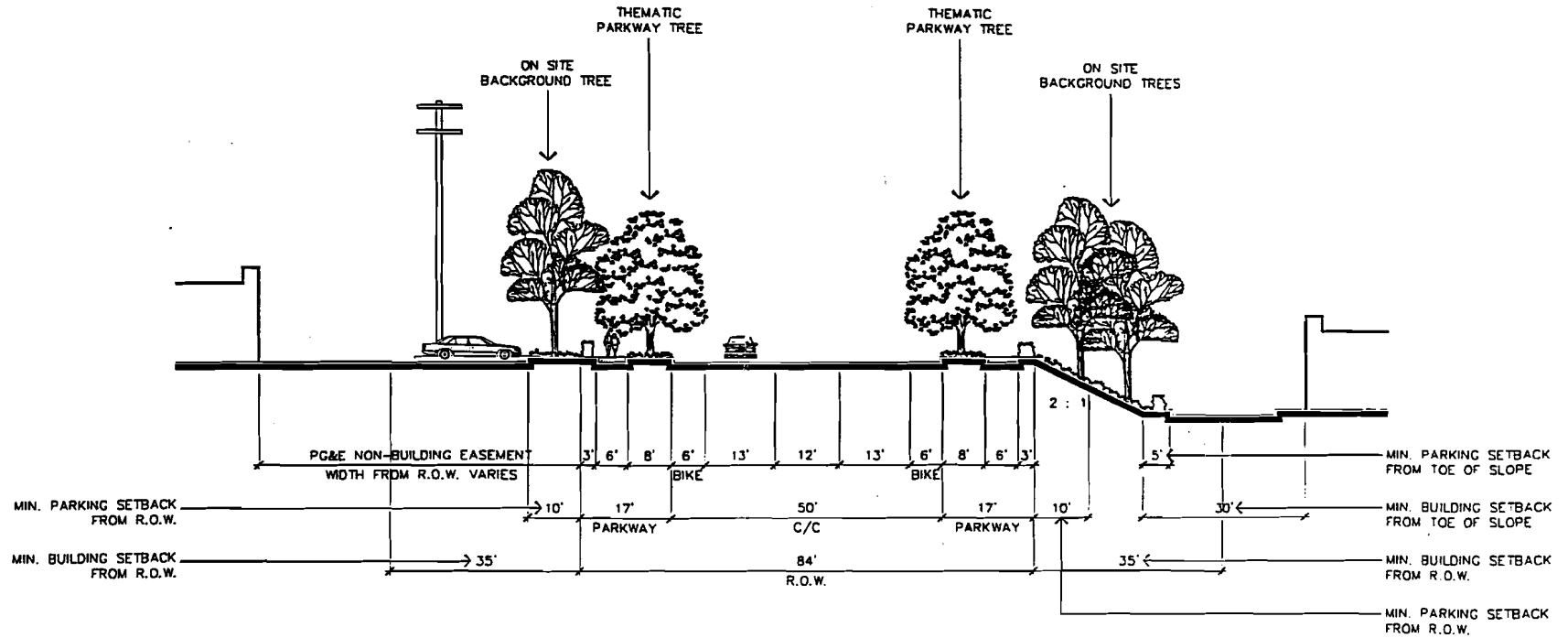

TOWN CENTER

WEST

WHITE ROCK ROAD

ULTIMATE - SECTION 1

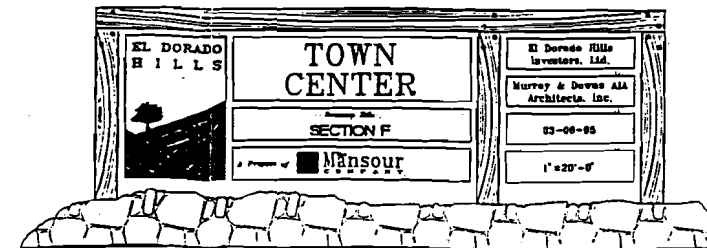
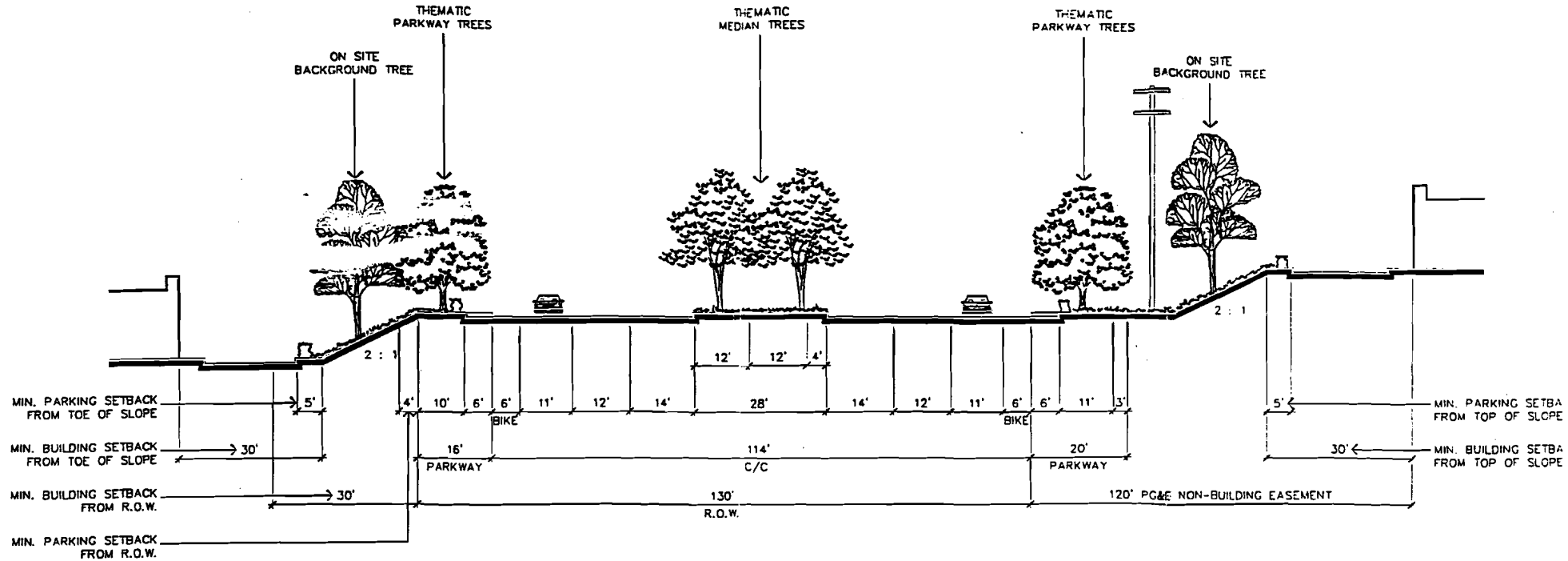

TOWN CENTER

WEST

WHITE ROCK ROAD

ULTIMATE - SECTION C

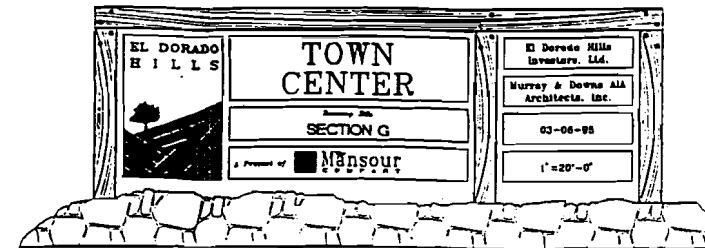
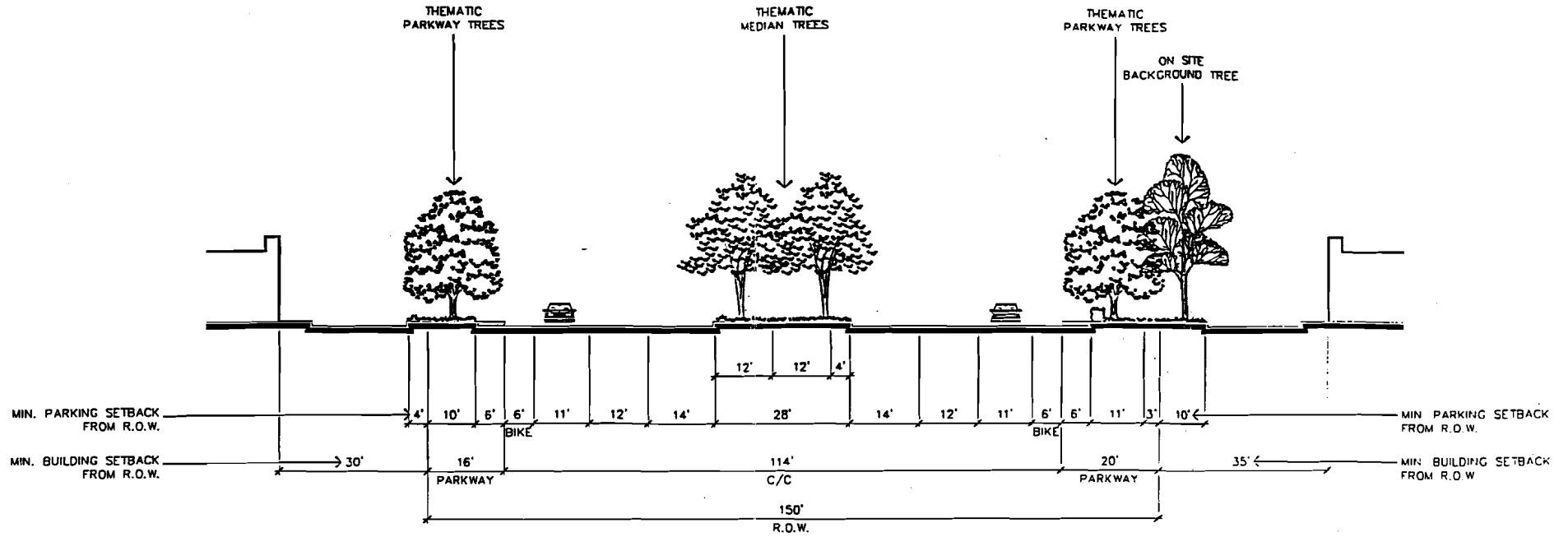

TOWN CENTER

WEST

U.S. HIGHWAY 50

SECTION H

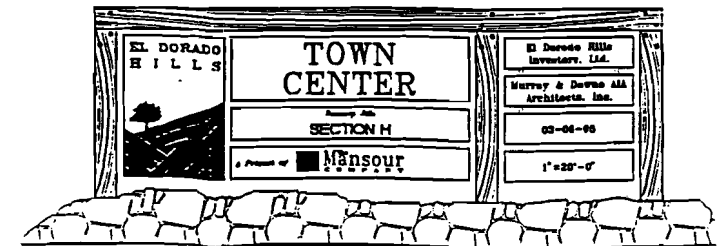
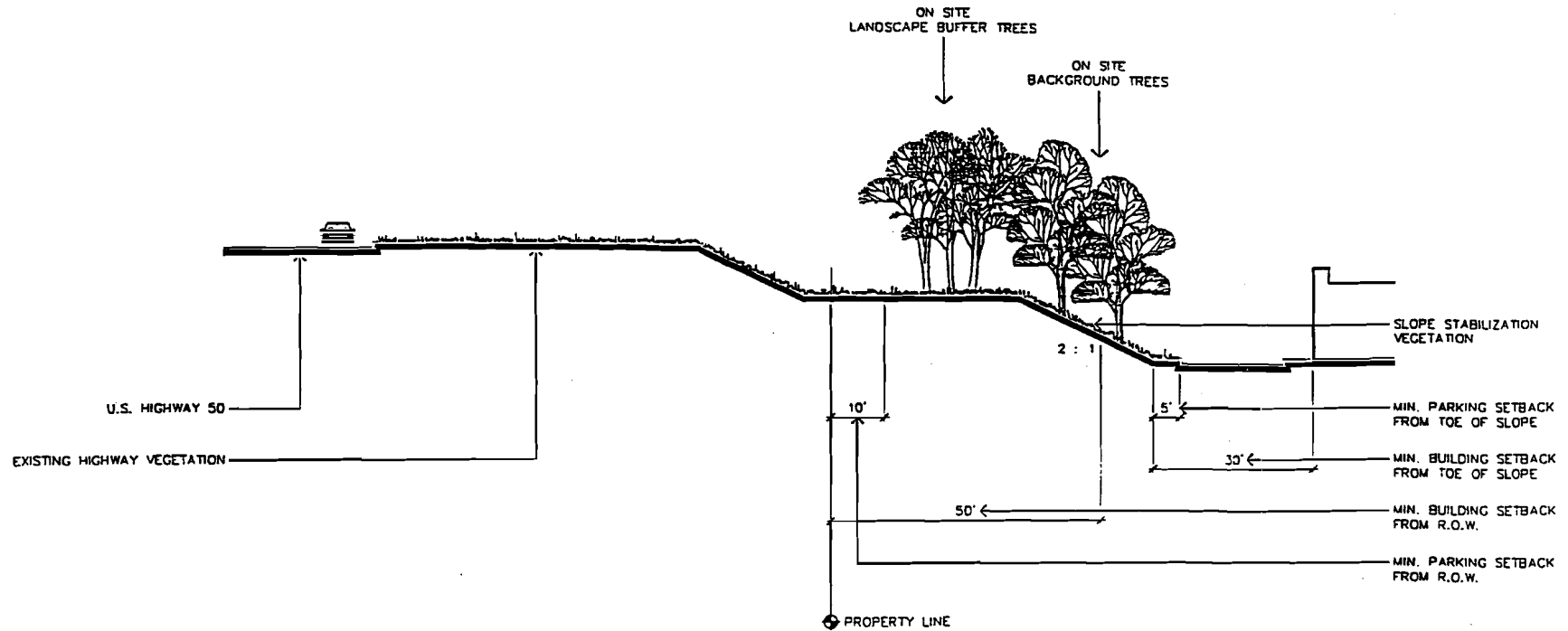

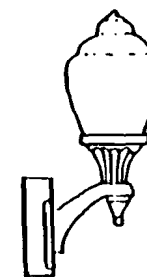
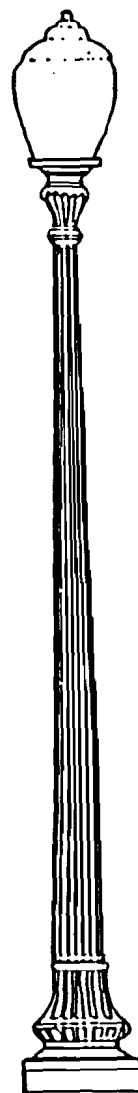
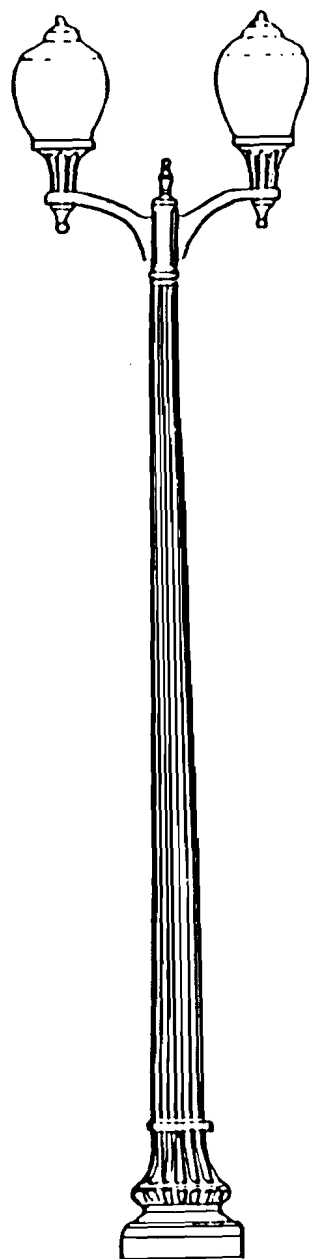

Lighting

Austin Series

- Globe RC9118
- Pole 11-185
- Base BA105
- Crossarm CA302
- Bollard BA105

Antique Street Lamps, Inc
8412 South Congress
Austin, Texas 78745
(512) 282-9780

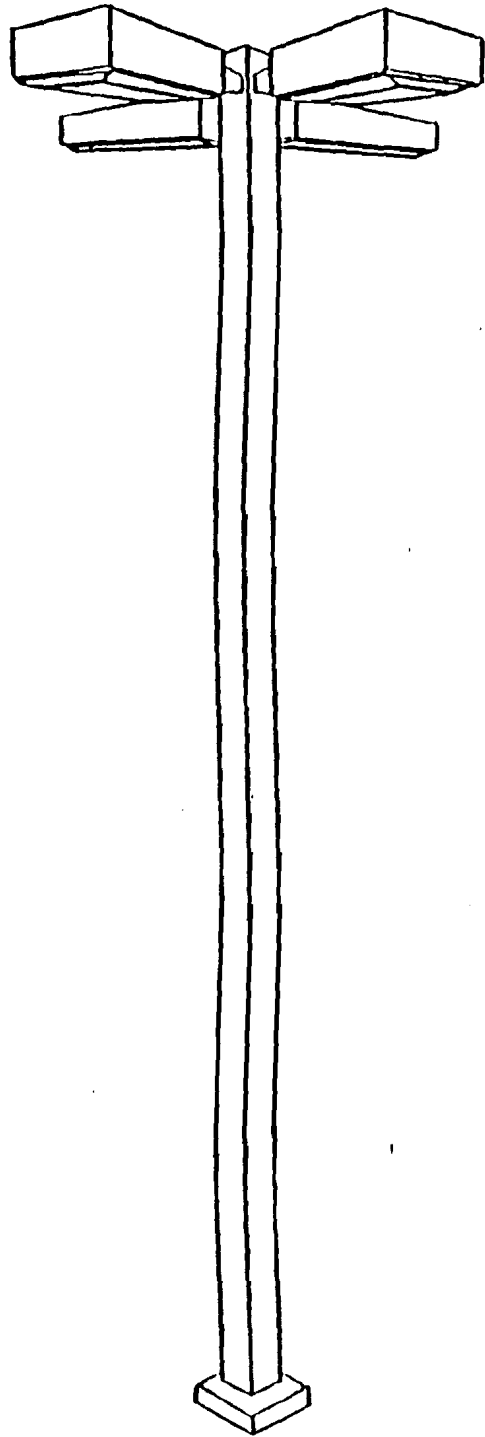

**Parking Lot Lighting
Down Light Box (typical)**

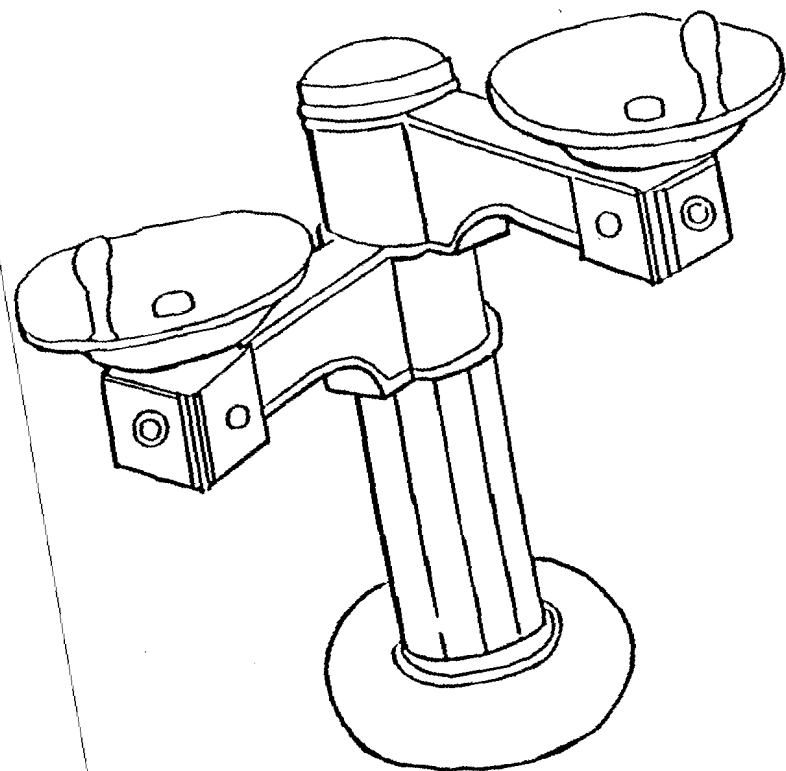
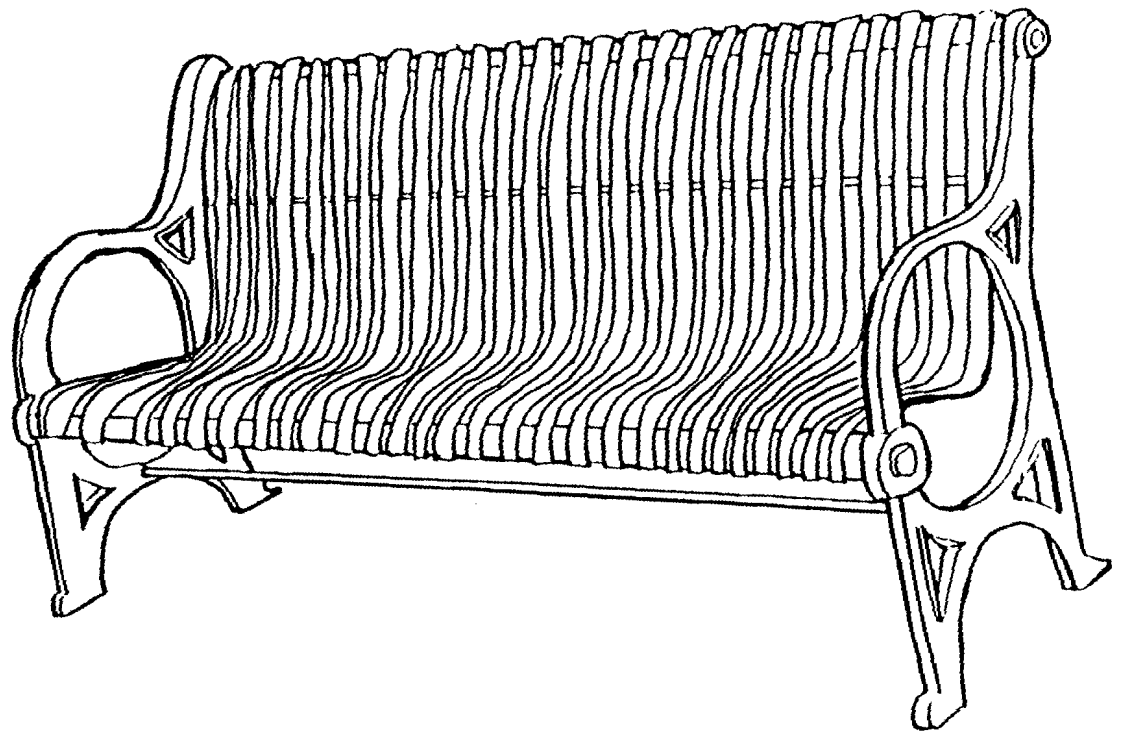

**Drinking Fountains
Metro Series**

**Seating
Bowery Bench (w/cast iron leg)**

**Canterbury International
5632 W. Washington Blvd.
Los Angeles, CA 90016
(213) 936-7111**

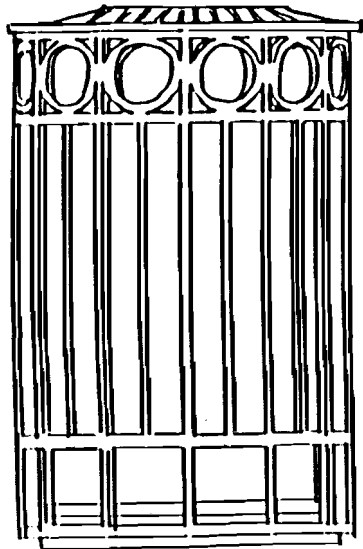
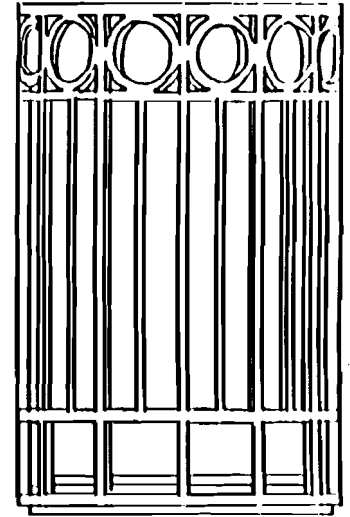
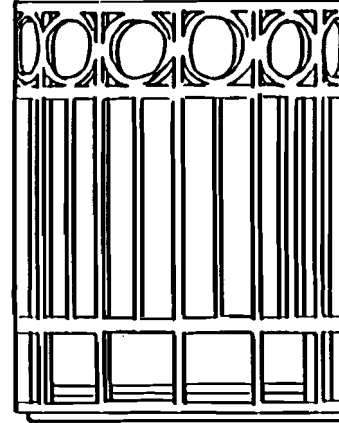
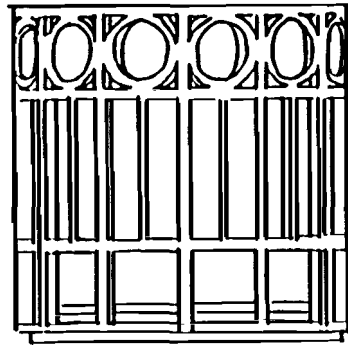
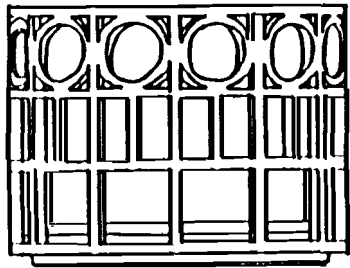

Trash Receptacles
Pennsylvania Avenue Series

Free Standing Planters
Pennsylvania Avenue Series

Canterbury International
5632 W. Washington Blvd.
Los Angeles, CA 90016
(213) 936-7111

Appendix 3 - Specific Landscape Criteria

The following Specific Landscape Criteria is comprised of two components: 1) the elements specific to the street rights-of-way and 2) the elements specific to the individual Planning Areas. It is suggested the user first familiarize himself with the elements of the street right-of-way adjacent to his parcel before referring to the individual Planning Area.

**EL DORADO HILLS TOWN CENTER
Town Center West Landscape Elements**

Latrobe Road

- | | | | | |
|-----|--|---|------------------|-------------|
| 1. | <p>Thematic Median Tree
Bradford Pear</p> | <p>30' on center
Pyrus Calleryana 'Bradford'</p> | <p>15 gallon</p> | <p>100%</p> |
| 2. | <p>Thematic Parkway Tree
American Sweetgum</p> | <p>30' on center
Liquidambar Styraciflua 'Palo Alto'</p> | <p>15 gallon</p> | <p>100%</p> |
| 3. | <p>Shrub Palette - Nursery stock sizes chosen by the initial landscape architect shall become the standard for future phases.</p> | | | |
| 3.1 | <p>Median
Compact Oregon Grape
Cotoneaster</p> | <p>Mahonia aquifolium 'Compacta'
(varieties)</p> | | |
| 3.2 | <p>Roadside
Howard McMinn
Manzanita
Crimson Spot Rockrose
Cotoneaster
Hybrid Oregon Grape
Toyon
Day Lilly</p> | <p>Arctostaphylos d. 'Howard McMinn'

Cistus ladanifer
(varieties)
Mahonia 'Golden Abundance'
Heteromeles Arbutifolia
Hemerocallis (Hybrid varieties)</p> | | |
| 4. | <p>Ground Cover Palette - Nursery stock sizes chosen by the initial landscape architect shall become the standard for future phases.</p> | | | |
| 4.1 | <p>Median
St. Johnswort</p> | <p>Hypericum calycinum</p> | | |
| 4.2 | <p>Roadside
Turf-type tall fescue
St. Johnswort
Knotweed</p> | <p>'Trophy' or 'Survivor' Endophyte-enhanced turf type
Hypericum calycinum
Polygonum Capitatum</p> | | |

**EL DORADO HILLS TOWN CENTER
Town Center West Landscape Elements**

White Rock Road

- | | | | | |
|-----|---|--|-----------|------|
| 1. | Thematic Median Tree
Red Horsechestnut | 30' on center
Aesculus carnea 'Briotii' | 15 gallon | 100% |
| 2. | Thematic Parkway Tree
London Plane tree | 30' on center
Platanus acerifolia 'bloodgood' | 15 gallon | 100% |
| 3. | Shrub Palette - Nursery stock sizes chosen by the initial landscape architect shall become the standard for future phases. | | | |
| 3.1 | Median
Juniper
Spiraea | Juniperus (varieties)
Spiraea bumalda | | |
| 3.2 | Roadside
Glossy Abelia
Cotoneaster
Hybrid Oregon Grape
Zabel Laurel
Juniper
Spiraea | Abelia grandiflora 'Ed Goucher'
(varieties)
Mahonia 'Golden Abundance'
Prunus l. 'Zabeliana'
Juniperus varieties)
Spiraea bumalda | | |
| 4. | Ground Cover Palette - Nursery stock sizes chosen by the initial landscape architect shall become the standard for future phases. | | | |
| 4.1 | Median
St. Johnswort
Knotweed | Hypericum calycinum
Polygonum Capitatum | | |
| 4.2 | Roadside
Turf-type tall fescue
Low Cotoneaster
St. Johnswort
Knotweed | 'Trophy' or 'Survivor' Endophyte-enhanced turf type
Cotoneaster 'Lowfast'
Hypericum calycinum
Polygonum capitatum | | |

**EL DORADO HILLS TOWN CENTER
Town Center West Landscape Elements**

Town Center Boulevard (all segments)

- | | | | | |
|-----|--|---|-----------|------|
| 1. | Thematic Median Tree
Purple-leaf plum | 30' on center
Prunus 'Krauter-Vesuvius' | 15 gallon | 100% |
| 2. | Thematic Parkway Tree
Red Maple | 30' on center
Acer rubrum 'October Glory' | 15 gallon | 100% |
| 3. | Shrub Palette - Nursery stock sizes chosen by the initial landscape architect shall become the standard for future phases. | | | |
| 3.1 | Median
Juniper
Spiraea | Juniperus (varieties)
Spiraea Bumalda | | |
| 3.2 | Roadside
Spiraea
Sumac
Flowering currant
Privet
Glossy Abelia
Flowering Quince | Spiraea bumalda
Rhus (varieties)
Ribes (varieties)
Ligustrum (varieties)
Abelia grandiflora 'Ed Goucher'
Chaenomeles (varieties) | | |
| 4. | Ground Cover Palette - Nursery stock sizes chosen by the initial landscape architect shall become the standard for future phases. | | | |
| 4.1 | Median
Dwarf Periwinkle
Knotwee | Vinca minor
Polygonum capitatum | | |
| 4.2 | Roadside
Low Cotoneaster
English Ivy
Dwarf Periwinkle
Turf-type tall fescue | Cotoneaster 'Lowfast'
Hedera helix
Vinca minor
'Trophy' or 'Survivor' Endophyte-enhanced turf type | | |

**EL DORADO HILLS TOWN CENTER
Town Center West Landscape Elements**

D Street

1. Thematic Parkway Tree 30' on center 15 gallon 100%
European Hackberry Celtis australis

2. Shrub Palette - Nursery stock sizes chosen by the initial landscape architect shall become the standard for future phases.

Glossy Abelia	Abelia grandifolia 'Ed Goucher'
Flowering Currant	Ribes (varieties)
Cotoneaster	Cotoneaster (varieties)
Hybrid Oregon Grape	Mahonia 'Golden Abundance'
Zabel Laurel	Prunus l. 'Zabeliana'

3. Ground Cover Palette - Nursery stock sizes chosen by the initial landscape architect shall become the standard for future phases.

Turf-type tall fescue	'Trophy' or 'Survivor' Endophyte enhanced turf type
Low Cotoneaster	Cotoneaster 'Lowfast'
St. Johnswort	Hypericum calycinum
Knotweed	Polygonum capitatum

**EL DORADO HILLS TOWN CENTER
Town Center West Landscape Elements**

Entry Corner Cut-offs

1. Major and Minor Entries - shall incorporate Town Center West Identification Monument signage at intersection of Town Center Boulevard with Latrobe Road and D Street with White Rock Road.

- | | | | | |
|-----|---|----------------------|---------|------|
| 1.1 | Thematic Foreground Tree
Flowering Crabapple | Malus Floribunda | 24" box | 100% |
| 1.2 | Thematic Background Tree
Coast Redwood | Sequoia sempervirens | 24" box | 100% |

2. Site Specific Entry Elements - shall replicate major and minor Town Center West entries and shall incorporate user identification monument signage. See Town Center West Design Guidelines and Development Standards Appendix 5 - Master Signage Program.

- | | | | | |
|-----|--|----------------------|---------|------|
| 2.1 | Thematic Background Tree
Coast Redwood | Sequoia sempervirens | 24" box | 100% |
| 2.2 | Thematic Tree
Red Flowering
Crabapple | Malus 'Red-Silver' | 24" box | 100% |

3. Shrub Palette - major and minor entries and site specific entries. Nursery stock sizes chosen by the initial landscape architect shall become the standard for future phases.

- | | |
|------------------------------|---------------------------------|
| Spiraea | Spiraea Bumalda |
| Flowering Currant | Ribes (varieties) |
| Juniper | Juniperus (varieties) |
| Hybrid Oregon Grape | Mahonia 'Golden Abundance' |
| Day Lillies | Hemerocallis (hybrid varieties) |
| Crimson Spot Rockrose | Cistus Ladanifer |

4. Groundcover Palette - major and minor entries and site specific entries. Nursery stock sizes chosen by the initial landscape architect shall become the standard for future phases.

- | | |
|------------------------------|---|
| English Ivy | Hedera Helix |
| Dwarf Periwinkle | Vinca minor |
| Juniper | Juniperus (varieties) |
| Turf-type tall fescue | 'Trophy' or 'Survivor' Endophyte enhanced turf type |

**EL DORADO HILLS TOWN CENTER
Town Center West Landscape Elements**

U.S Highway 50 Landscape Buffer

1. On-Site Background Trees - shall be clustered into groves at random locations. Trunk to trunk spacing shall not exceed 30 feet and groves shall be not be farther than 75 feet apart measured between trunks of outermost trees within each grove. Planting size mix shall be:

15 gallon	60%
24" box	30%
36" box	10%

- 1.1 Evergreen
- | | |
|----------------------------|----------------------------|
| Coast Redwood | Sequoia semp. 'Aptos Blue' |
| Japanese Black Pine | pinus thunbergiana |
- 1.2 Deciduous
- | | |
|-----------------------------|-----------------------|
| River Birch | Betula Nigra |
| Washington Hawthorne | Crataegus phaenopyrum |

2. Shrub Palette - Nursery stock sizes chosen by the initial landscape architect shall become the standard for future phases.

Manzanita	Arctostaphylos d. 'Howard McMinn'
Parney Cotoneaster	Cotoneaster Lacteus
Toyon	Heteromeles arbutifolia
Italian Buckthorn	Rhamnus alternatus
Silktassel	Garrya e. 'James Roof'
Flannel Bush	Fremontodendron 'California Glory'

3. Groundcover Palette - Nursery stock sizes chosen by the initial landscape architect shall become the standard for future phases.

Dwarf Coyote Brush	Baccharis pilularis 'Twin Peaks'
Low Cotoneaster	Cotoneaster 'Lowfast'

**EL DORADO HILLS TOWN CENTER
Town Center West Landscape Elements**

West Boundary Landscape Buffer

1. On-Site Background Trees - shall be clustered into groves at random locations. Trunk to trunk spacing shall not exceed 30 feet and groves shall be not be farther than 50 feet apart measured between trunks of outermost trees within each grove. Grove plantings shall combine with hedgerow plantings to create a visual barrier between Town Center West and the adjacent residential property.

Planting Sizes	15 gallon	60%
	24" box	30%
	36" box	10%

- 1.1 Evergreen
 - Coast Redwood** Sequoia semp. 'Aptos Blue'
 - Japanese Black Pine** pinus thunbergiana

- 1.2 Deciduous
 - River Birch** Betula Nigra
 - Washington Hawthorne** Crataegus phaenopyrum

2. Shrub Palette - At the time of development within Planning Areas B and D of Town Center West and in those areas where the elevation at the west boundary/property line is less than 8 feet above the average constructed grade of any adjacent residential lot/parcel, a hedgerow of shrub plantings shall be installed. Planting materials for the hedgerow shall be a minimum of 15 gallons in size and spaced according to specie requirements to create a visual barrier within 5 years.

Manzanita	Arctostaphylos d. 'Howard McMinn'
Parney Cotoneaster	Cotoneaster Lacteus
Toyon	Heteromeles arbutifolia
Italian Buckthorn	Rhamnus alternatus
Silktassel	Garrya e. 'James Roof'
Flannel Bush	Fremontodendron 'California Glory'

3. Groundcover Palette - Nursery stock sizes chosen by the initial landscape architect shall become the standard for future phases.

Dwarf Coyote Brush	Baccharis pilularis 'Twin Peaks'
Low Cotoneaster	Cotoneaster 'Lowfast'

EL DORADO HILLS TOWN CENTER

Town Center West Landscape Elements

All Planning Areas

1. On-site Background Trees - adjacent to Parkway plantings. On site Background Trees shall be clustered into groves at random locations. Trunk to trunk spacing shall not exceed 30 feet and groves shall be not be farther than 75 feet apart measured between trunks of outermost trees within each grove. Planting size mix shall be:

	15 gallon	70%
	24" box	30%

 - 1.1 Evergreen

Coast Redwood	Sequoia semp. 'Aptos Blue'
Japanese Black Pine	Pinus thunbergiana
Glossy Privet	Ligustrum lucidum
 - 1.2 Deciduous Trees

Little Leaf Linden	Tilia cordata
European Hackberry	Celtis australis
River Birch	Betula nigra
Washington Hawthorn	Crataegus phaenopyrum

2. On-site General Purpose Trees - Planting sizes shall be consistent with the proposed application and shall be subject to approval of the Design Review Committee. Planting size mix shall be:

	15 gallon	70%
	24"box	20%
	36" box	10%

 - 2.1 Evergreen Trees

Coast Redwood	Sequoia semp. 'Aptos Blue'
Italian Stone Pine	Pinus Pinea
California Bay	Umbelularia californica
Glossy Privet	Ligustrum lucidum
Deodar Cedar	Cedrus deodara
 - 2.2 Deciduous Trees

Norway Maple	Acer platenoides
European Hackberry	Celtis australis
Sweetgum	Liquidambar styraciflua 'Palo Alto'
White Birch	Betula pendula
Saucer Magnolia	Magnolia soulangeana
Crabapple	Malus Liset
Flowering Pear	Pyrus 'Aristocrat'
Purple Plum	Prunus Cerasifera 'Thundercloud'
Tulip Tree	Liriodendron tulipifera

**EL DORADO HILLS TOWN CENTER
Town Center West Landscape Elements**

All Planning Areas (continued)

3. Shrub Palette - Planting sizes shall be consistent with the proposed application and shall be subject to approval of the Design Review Committee. Planting sizes mix shall be:

5 gallon	70%
15 gallon	20%
24" box	10%

Strawberry Tree	Arbutus unedo
Flowering Quince	Chaenomeles (varieties)
Western Dogwood	Cornus stolonifera
Rhododendron	Rhododendron (varieties)
Manzanita	Arctostaphylos (varieties)
Privet	Ligustrum (varieties)
Common Lilac	Syringa (varieties)
Viburnum	Viburnum (varieties)
Pyracantha	Pyracantha (varieties)
Glossy Abelia	Abelia grandiflora 'Ed Goucher'
Boxwood	Buxus (varieties)
Cotoneaster	Cotoneaster (varieties)
Day Lilly	Hemerocallis (varieties)
Juniper	Juniperus (varieties)
Oregon Grape	Mahonia (varieties)
Spiraea	Spiraea (varieties)

4. Groundcover and Vine Palette - Planting sizes shall be consistent with the proposed application and shall be subject to approval of the Design Review Committee.

Boston Ivy	Parthenocissus tricuspidata
Lady Banks Rose	Rosa banksaea 'Alba Plena'
Purple Chinese Wisteria	Wisteria sinensis
Hahn's Ivy	Hedera helix 'Hahn's'
Dwarf Periwinkle	Vinca minor
Turf-type tall fescue	'Trophy' or 'Survivor' Endophyte-enhanced turf type

5. Parking Lot Trees - Trees shall be planted and maintained throughout surfaced parking lots to ensure that, within 15 years after planting, a minimum of 40 percent of the parking lot will be shaded. Planting size shall be:

15 gallon	100%
-----------	------

Honeylocust	Gleditsia triacanthos 'Shademaster'
--------------------	-------------------------------------

TOWN CENTER

ON-SITE

WEST

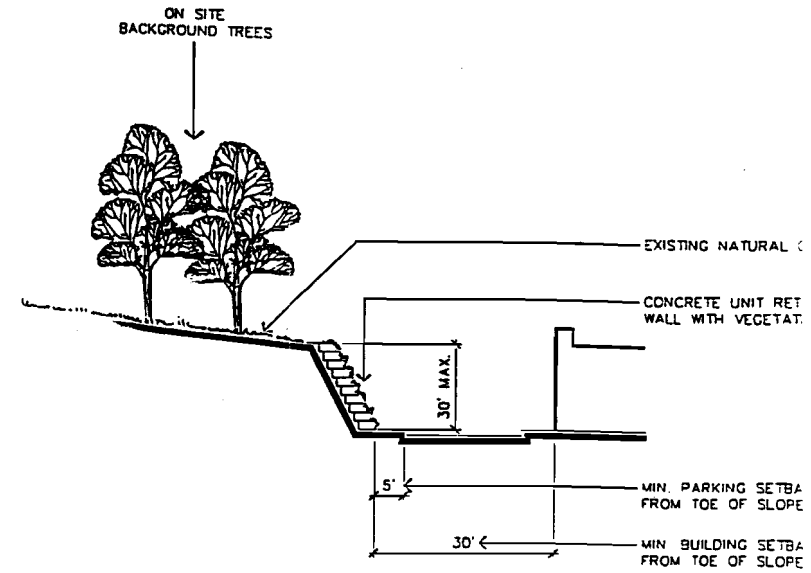

TOWN CENTER

ON-SITE CUT AND FILL SLOPE

WEST

SECTION J

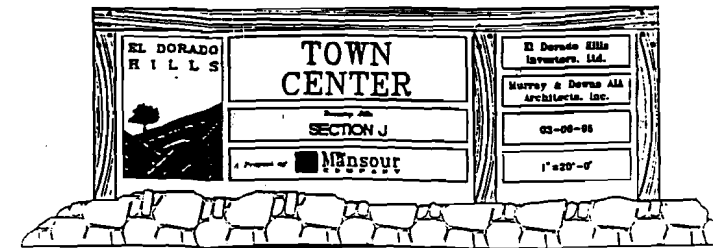
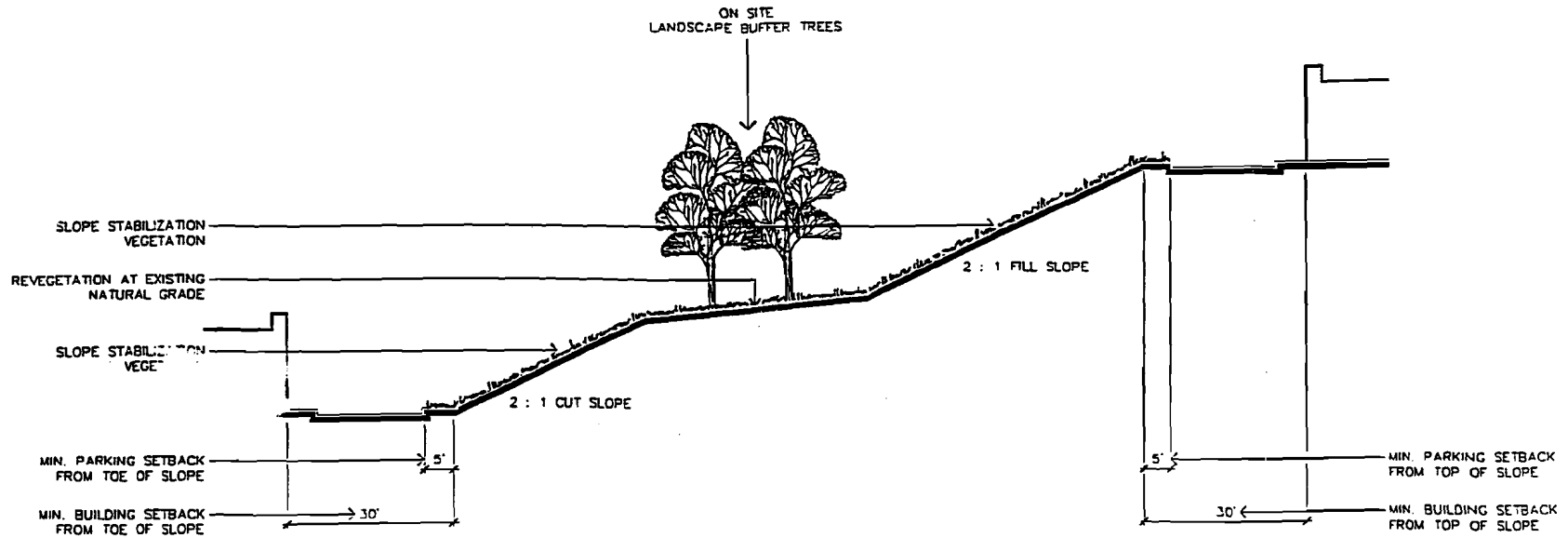

TOWN CENTER WEST PROPERTY LINE (CUT SLOPE)

WEST

SECTION K

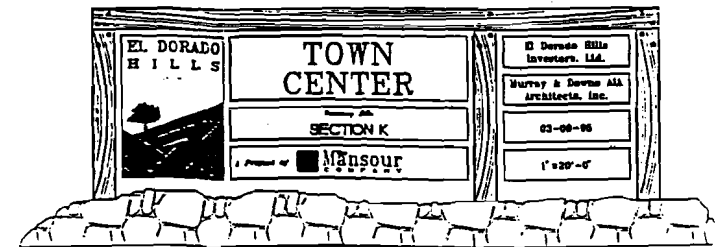
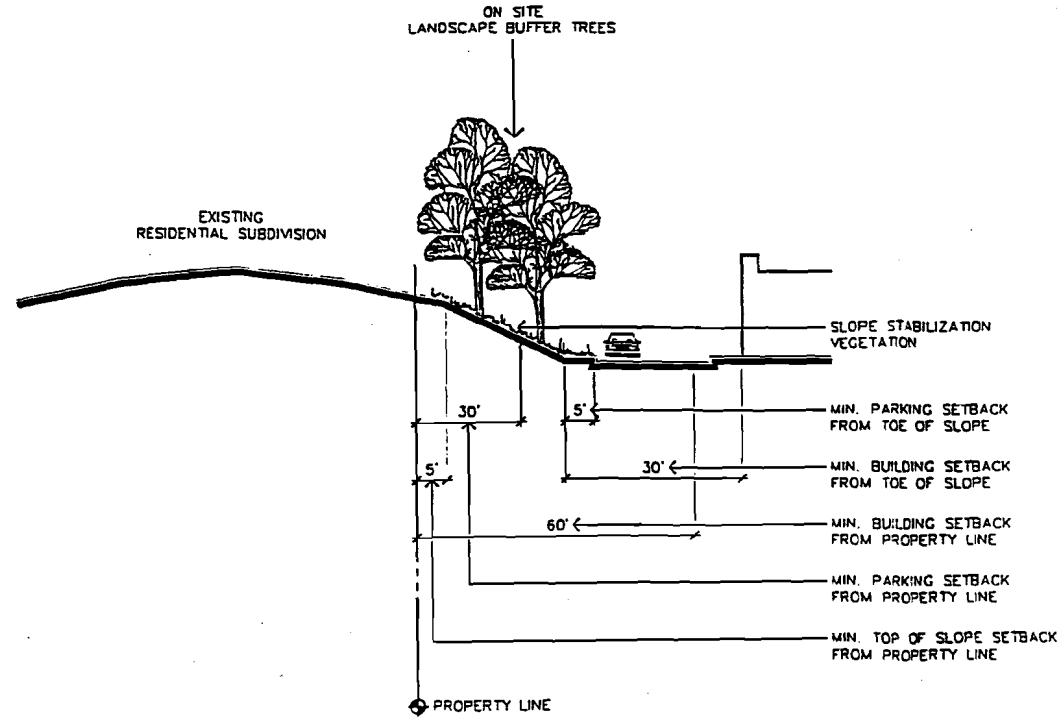

TOWN CENTER

WEST PROPERTY LINE (AT GRADE)

WEST

SECTION L

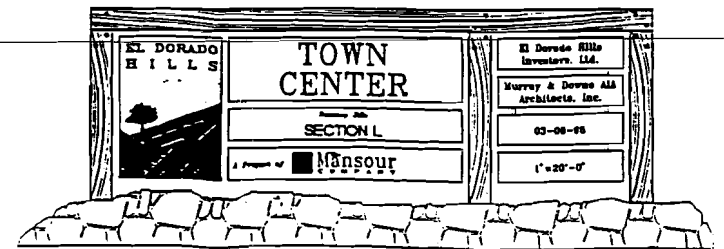
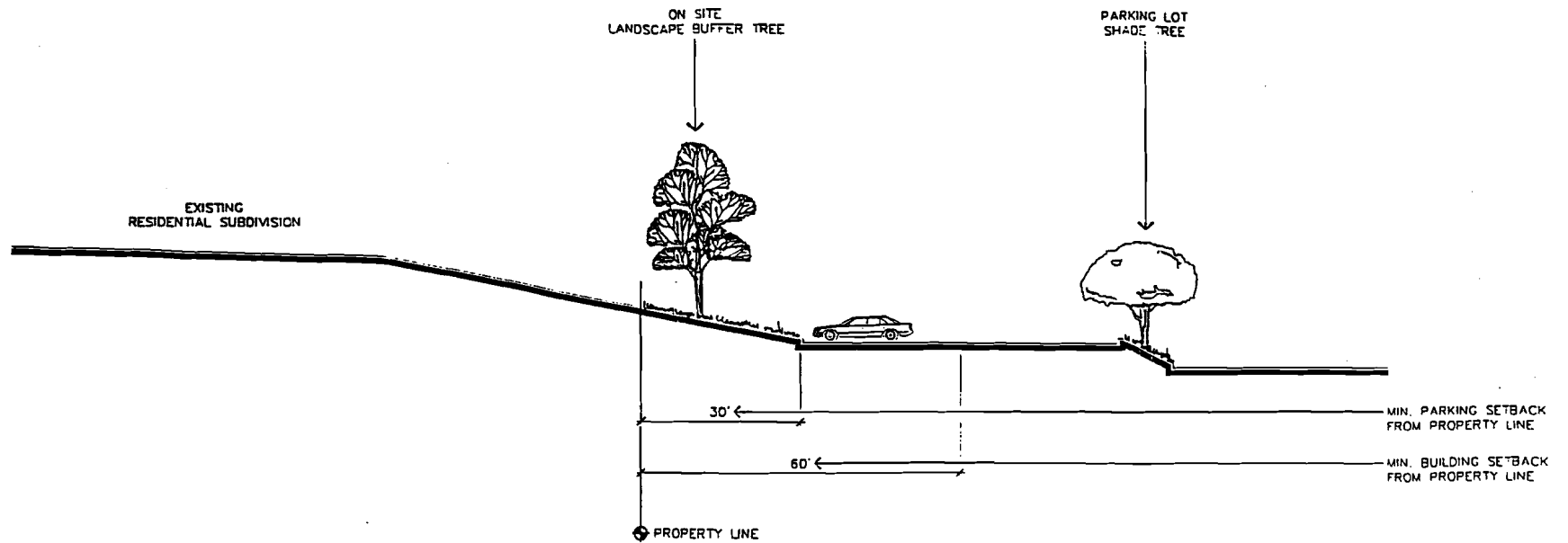





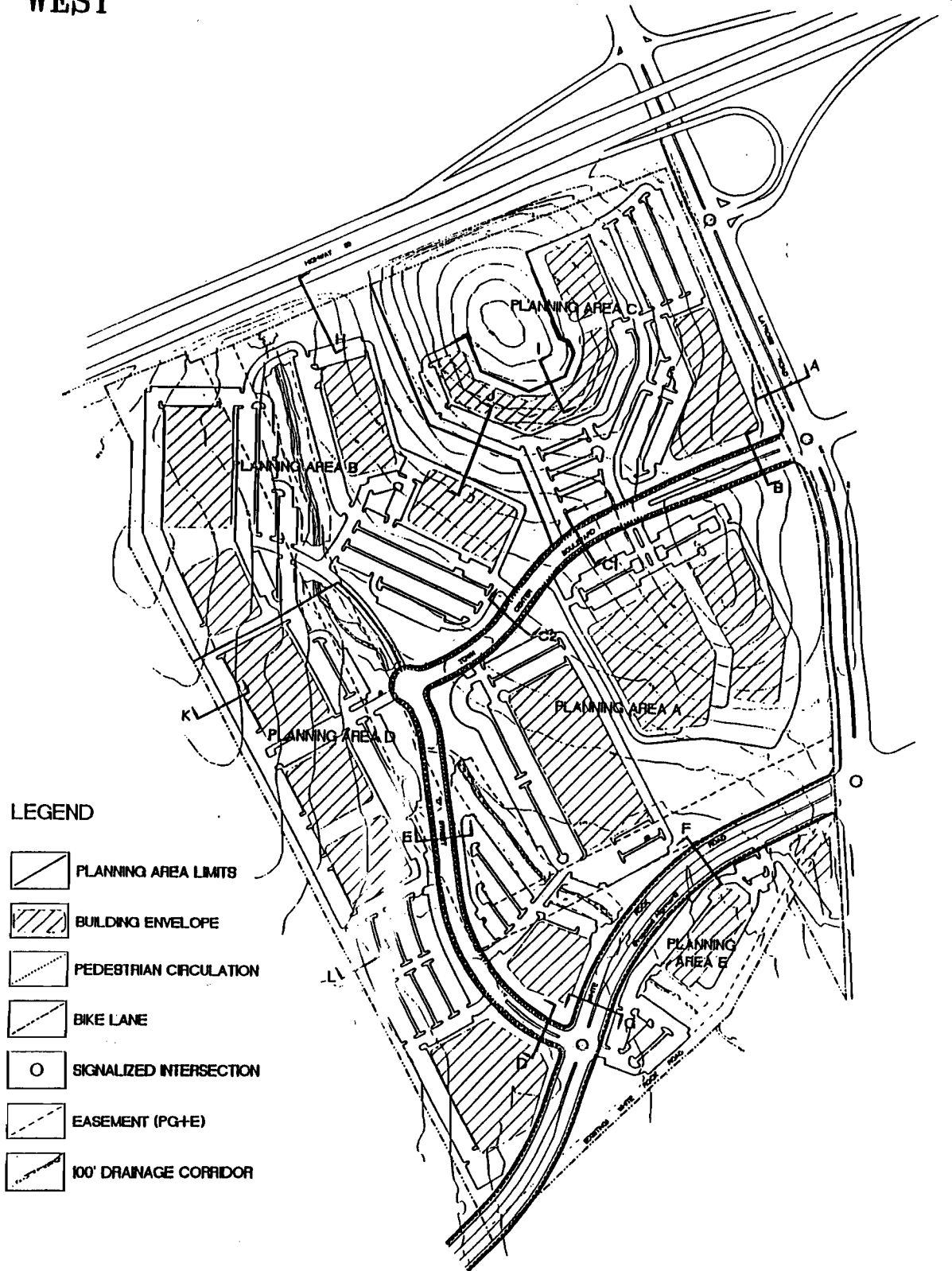

TOWN CENTER

WEST

KEY MAP



LEGEND

-  PLANNING AREA LIMITS
-  BUILDING ENVELOPE
-  PEDESTRIAN CIRCULATION
-  BIKE LANE
-  SIGNALIZED INTERSECTION
-  EASEMENT (PG+E)
-  100' DRAINAGE CORRIDOR

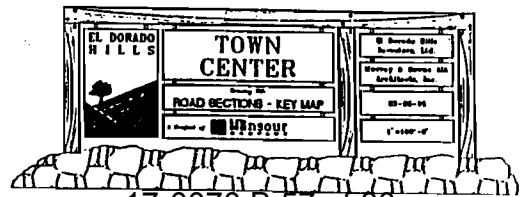

Appendix 4 - Specific Lighting Criteria

The Specific Lighting Criteria is comprised of three components: 1) the elements specific to the street rights-of-way, 2) the elements specific to parking lots and 3) the elements specific to the individual Planning Areas. It is suggested the user first familiarize himself with the elements of the street right-of-way adjacent to his parcel before referring to the individual Planning Area.

(Manufacturer may be substituted provided material and fabrication is determined to be "equal or better" by the Design Review Committee.)

Town Center Boulevard

-	Entry Intersection	Austin Series:	5-globe unit: one unit per corner
		Pole Height:	Uniform: not to exceed 24 feet
		Footcandles:	1.5 standard
		Spacing:	As required to maintain standard
-	Median	Austin Series	2-globe unit: triangulated with roadside units
		Pole Height:	Uniform: not to exceed 24 feet
		Footcandles:	1.0
		Spacing:	As required to maintain standard
-	Roadside	Austin Series:	Single globe unit: triangulated with median units
		Pole Height:	Uniform: not to exceed 24 feet
		Footcandles:	1.0
		Spacing:	As required to maintain standard

D Street

-	Roadside	Austin Series:	Single globe unit
		Pole Height:	Uniform: not to exceed 24 feet
		Footcandles:	0.5
		Spacing:	As required to maintain standard

Parking Lot Lighting

-	Standard Interior	(To Be Named):	Downlight cutoff "shoebox" fixture (model # to be determined)
		Pole Height:	Uniform: not to exceed 24 feet
		Footcandles:	1.5
		Spacing:	As required to maintain standard
-	End Aisle Accent	Austin Series:	(as determined by user)
		Pole Height:	Uniform: not to exceed 16 feet
		Footcandles:	1.0

Appendix 4 - Specific Lighting Criteria (continued)

- Walkway Intersections

Austin Series:	(as determined by user)
Pole Height:	Uniform: not to exceed 16 feet
Footcandles:	1.0
Spacing:	not applicable

- Planning Areas A, B, C, D and E**
- Accent Post Lighting

Austin Series	(as determined by user)
Pole Height:	Uniform: not to exceed 16 feet
Footcandles:	1.0
Spacing:	not applicable

- Supplemental Pedestrian Lighting

Austin Series	Bollard
Footcandles:	0.5
Spacing:	As required to maintain standard

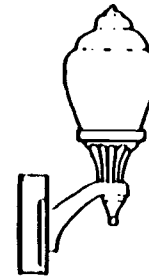
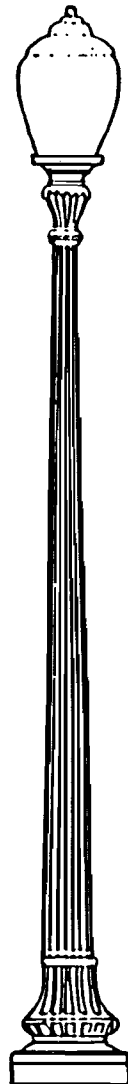
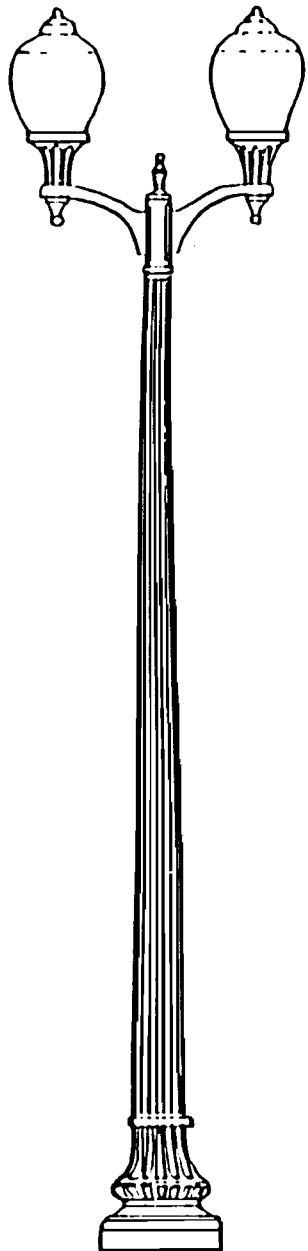

Lighting

Austin Series

- Globe RC9118
- Pole 11-185
- Base BA105
- Crossarm CA302
- Bollard BA105

Antique Street Lamps, Inc
8412 South Congress
Austin, Texas 78745
(512) 282-9780

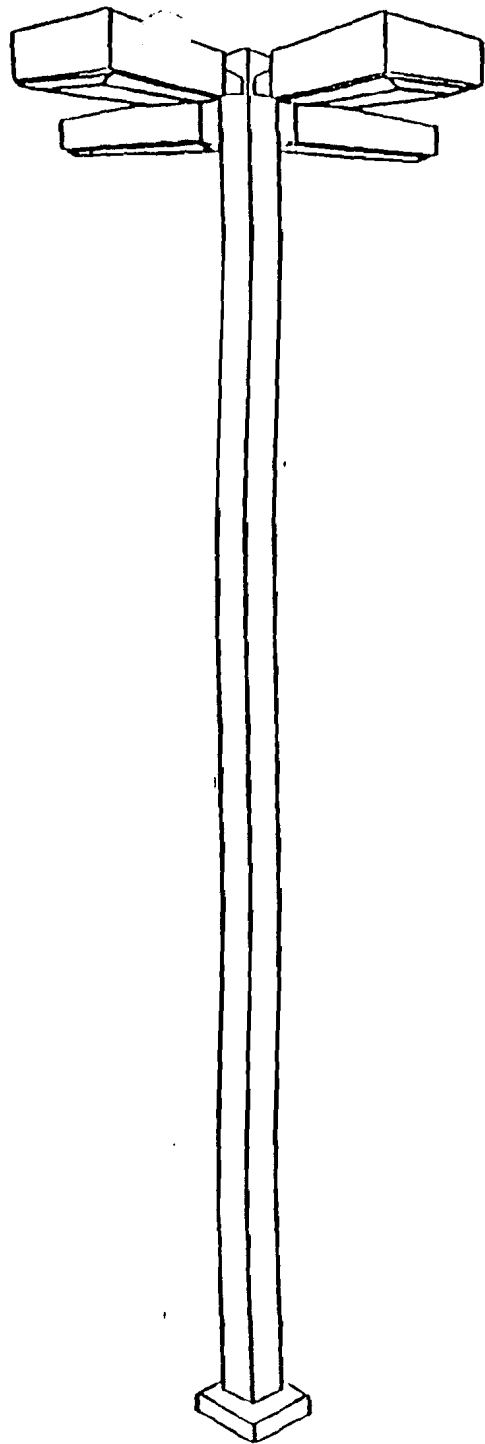

**Parking Lot Lighting
Down Light Box (typical)**

Appendix 5 - Master Signage Program - Town Center West

TABLE OF CONTENTS

- 1.0 Introduction
- 2.0 Signage Concept
- 3.0 General Design Requirements
- 4.0 Town Center Identification Signage
 - 4.1 Highway Oriented Sign
 - 4.2 Major Town Center West Entry Signs
 - 4.3 Minor Town Center West Entry Signs
- 5.0 Directional and Regulatory Signage
 - 5.1 General Directional Signs
 - 5.2 Auto/Pedestrian Directional Signs
- 6.0 User Identification/Information Signs
 - 6.1 Town Center East (intentionally deleted)
 - 6.2 Town Center West
 - 6.2.1 Identification Monument
 - 6.2.2 On-Site Convenience Sign
 - 6.2.3 On-Building Identification Sign - Office User
 - 6.2.4 On-Building Identification Sign - Hotel User
 - 6.2.5 On-Building Identification Sign - In-Line retail User
 - 6.2.6 Building Address Display
- 7.0 Temporary Signage
 - 7.1 Flags and Banners
 - 7.2 Special Event Signs/Devices
 - 7.3 Marketing Construction Signs

EL DORADO HILLS TOWN CENTER MASTER SIGNAGE PROGRAM

Town Center West

1.0 Introduction

1.1 Objectives

The planning, architecture and landscaping of the El Dorado Hills Town Center reflect the intention that Town Center provide a high quality environment for its tenants, patrons and the community-at-large. Recognizing that development within Town Center will progress in stages according to market demand, the signage program will respond to properly reflect the scope and scale of Town Center's development during the build-out time frame.

1.2 Intent

The following Master Signage Program has been prepared for the El Dorado Hills Town Center in order to establish overall standards for the design and regulation of signs and other graphic elements throughout the project. The program is intended to create a consistency in sign design that reinforces the overall image of Town Center while maintaining the means for individual user identification.

The Master Signage Program included general guidelines for the following sign types:

Project Identification Signage

Directional and Regulatory Signage

User Identification/Information Signage

Temporary Signage

EL DORADO HILLS TOWN CENTER MASTER SIGNAGE PROGRAM

Town Center West

2.0 Signage Concept

2.1 Project Identification Signage

The design of project identification elements will utilize the rail fence and rock wall theme developed for the Town Center. Colors shall be:

Forest Green (equal to PMS 555)

Golden Tan (equal to PMS 465 or equivalent as reflected in metals or metallic materials)

Materials, methods of construction and typeface style will be established by the initial developer and shall become the standard.

Perimeter signage shall consistently display the project symbol/logotype as a unifying graphic image.

Sign materials shall consist of steel I-beam members, natural or painted wood, painted metal and metal or composite dimensional letters. Materials shall be consistent with the proposed application and shall be approved by the Design Review Committee.

2.2 Directional/Information Signage

All auto and pedestrian oriented directional/informational signs shall use a common format based on the rail fence theme. Materials, colors and the project typeface and symbol/logotype shall be consistently applied to these elements throughout the project. Regulatory signs shall be similarly designed subject to approval by the Director of the Department of Transportation or other authority.

2.3 User Identification Monument Signage

User Identification Monument Signage shall replicate Project Identification Signage using the rail fence and rock wall theme. Users may display their individual corporate colors, symbols, logotypes and identities within the established format.

3.0 General Design Requirements

3.1 Site Specific Project Planner/Architect/Builder Responsibility

Each site specific project proponent shall review the El Dorado Hills Town Center Master Signage Program before preparing designs of specific project signs. Although previous signing practices with the Town Center will be considered, they will not govern the signs being currently submitted nor be the basis for deviation from the current standards. Each site specific project proponent shall comply with any other jurisdictional regulations as may be applicable. Approval by the Design Review Committee does not constitute approval by any County or State agency.

3.2 Design Review Committee Responsibility

The Design Review Committee will be responsible to interpret the Master Signage Program, review sign submittals and issue approvals of same. The Design Review Committee shall inspect completed signs to ensure compliance with the Master Signage Program only.

3.3 Property Owners Association

The Property Owners Association shall be responsible for the enforcement of the standards set forth in the Master Signage Program.

3.4 Non-Conforming Signs

The Design Review and/or Property Owners Association at their discretion, and at the project proponent's expense, will correct, replace or remove any sign that is installed without written approval and/or that is deemed not to be in conformance with the approved plans/project sign criteria.

3.5 Prohibited Signs

Only those signs provided for herein and specifically approved in writing by the Design Review Committee shall be allowed. No temporary wall or fascia signs, pennants, banners, flags, trailer signs, vehicles used for sign identity purposes, inflatable displays or sandwich boards shall be allowed.

4.0 Town Center Identification Signage

4.1 Highway Oriented Signs

Description:	Illuminated, single faced, freestanding pylon sign utilizing the rail fence and rock wall theme and displaying the El Dorado Hills Town Center symbol/logotype with provision for the display of a maximum of ten (10) retail commercial user names and/or symbols/logotypes and three (3) corporate user symbols/logotypes
Location:	Adjacent to U.S. Highway 50 approximately mid-point on the west face of the mound located in the northeast corner of the project area
Setback:	125 feet from property line/U.S. Highway 50 ROW line
Height:	32' from grade to top of sign
Overall Size:	40 feet wide, 28 feet high - 1120 square feet
Total Number of Signs:	One (1)

4.0 Town Center Identification Signage

4.2 Major Town Center West Entry Sign

Description:	Illuminated single-faced freestanding ground monument sign using the rail fence and rock wall theme and displaying the El Dorado Hills Town Center symbol/logotype. Town Center West designation and no more than three (3) corporate user symbols/logotypes
Location:	Within landscaped corner cut-offs at major entry at Latrobe Road and Town Center Boulevard
Setback:	minimum of 15 feet from ROW
Height:	5' - 6"
Maximum Square Footage	120 square feet (60 square feet each sign)
Total Number of Signs:	two (2) - one on each corner of intersection of Latrobe Road and Town Center Boulevard

4.0 Town Center Identification Signage

4.3 Minor Town Center West Entry Signs

Description:	Illuminated single-faced freestanding ground monument sign displaying the El Dorado Hills Town Center symbol/logotype and the Town Center West designation
Location:	Within landscaped corner cut-offs at minor entry at White Rock Road and D Street
Setback:	minimum of 10 feet from ROW
Height:	4' - 6"
Maximum Square Footage:	80 square feet (40 square feet each sign)
Total Number of Signs:	two (2) - one on each corner of intersection of White Rock Road and D Street

5.0 Directional and Regulatory Signage

5.1 General Directional Signs

Description:	Non-illuminated, single or double-faced, freestanding post and panel sign based on the rail fence theme established for the project.
Location:	As required
Setback:	As required
Height:	4' - 6"
Maximum Square Footage:	As required
Total number of Signs:	As required

5.0 Directional and Regulatory Signage

5.2 Auto/Pedestrian Directional Signs

Description:	Non-illuminated, single or double-faced, freestanding post and panel sign based on the rail fence theme established for the project.
Location:	As required
Setback:	As required
Height:	4' - 6"
Maximum Square Footage:	As required
Total number of Signs:	As required

6.2 Town Center West

6.2.1 User Identification Monument Signs

Description:	Illuminated, freestanding monument sign displaying a building or complex name or single or multiple user name(s). Individual corporate identification by symbol/logotype and/or color shall be permitted within the established format subject to approval of the Design Review Committee
Location:	At primary off-street entry to buildings or building complexes
Setback:	minimum of 10 feet from ROW
Height:	4' - 0"
Maximum Square Footage:	40 square feet
Total Number of Signs:	One (1) sign per lot. Building or building complex with two street frontages shall be allowed one (1) sign per street frontage

6.2 Town Center West

6.2.2 On-Site Convenience Sign

Description:	Illuminated and non-illuminated freestanding convenience signs identifying parking, exits, service/delivery entrances and code required regulatory signage; may be single or double-faced
Location:	On-site as needed
Setback:	As required
Height:	4' - 0"
Maximum Square Footage:	4 square feet
Total Number of Signs:	4 signs per lot

6.2 Town Center West

6.2.3 On-Building Identification Sign - Office User

Description:	Illuminated corporate identification letters/symbols
Location:	Building fascia, parapet or wall
Height:	Maximum letter height - 30 inches Maximum symbol height - 36 inches
Maximum Square Footage:	(length of sign may not exceed 70 percent of fascia, parapet or wall length on which sign is attached)
Total Number of Signs:	Two (2) signs

6.2.4 On-Building Identification Sign - Hotel User

Description:	Illuminated corporate identification letters/symbols
Location:	Building fascia, parapet or wall
Height:	Maximum letter height - 4' - 0" Maximum symbol height - 4' - 6"
Maximum Square Footage:	(Length of sign may not exceed 70 percent of fascia, parapet or wall length on which sign is attached)
Total Number of Signs:	Two (2) signs

6.2 Town Center West

6.2.5 On-Building Identification Sign - In-Line retail User

Description:	Illuminated user identification
Location:	Primary building elevation and attached to building fascia, parapet or wall
Height:	Maximum letter height - 18"
Maximum Square Footage:	35 square feet: overall length of sign shall not exceed 70 percent of the front footage of the shop between lease lines
Total Number of Signs:	One(1) per tenant storefront: users occupying corner spaces may have two (2) signs, one on each building elevation

6.2.6 Building Address Display

Description:	Mandatory address numerals for each building and/or tenant
Location:	To be uniformly displayed on the building face most visible from the street fronting the site
Height:	Not to exceed 12"

Appendix 6 - Improvements Phasing Plan

Improvement Phasing and Triggers.

All improvements to be completed prior to issuance of Certificate of Occupancy for any project within the subject Planning Area.

Phase I -Development of Planning sub-Area A-1 (the CPM 20 acre site) and Planning Area C (excepting the northwest quadrant which is to be held from development until completion of the PSR for U.S. Highway 50/El Dorado Hills boulevard Interchange).

Improvements: A Street (Town Center Boulevard) from Latrobe Road to the western-most driveway access of the CPM 20 acre site (approximately 1250 linear feet) as depicted on the Development Plan.

Phase II - Any development within Planning sub-Area A-2 or Planning Area B-1.

Improvements: Extend A Street (Town Center Boulevard) to its western terminus with D Street (subject to specific site plan approval by EDH Fire Department). If development is proposed for both areas concurrently, construction of D Street is required.

Phase III - Any development within Planning Area A-3, B-2, D-1, D-2 or E

Improvements: Design and construct D Street from the southern boundary of the project property through White Rock Road intersection and to its northern terminus with Town Center Boulevard.

TOWN CENTER

DEVELOPMENT PLAN

WEST

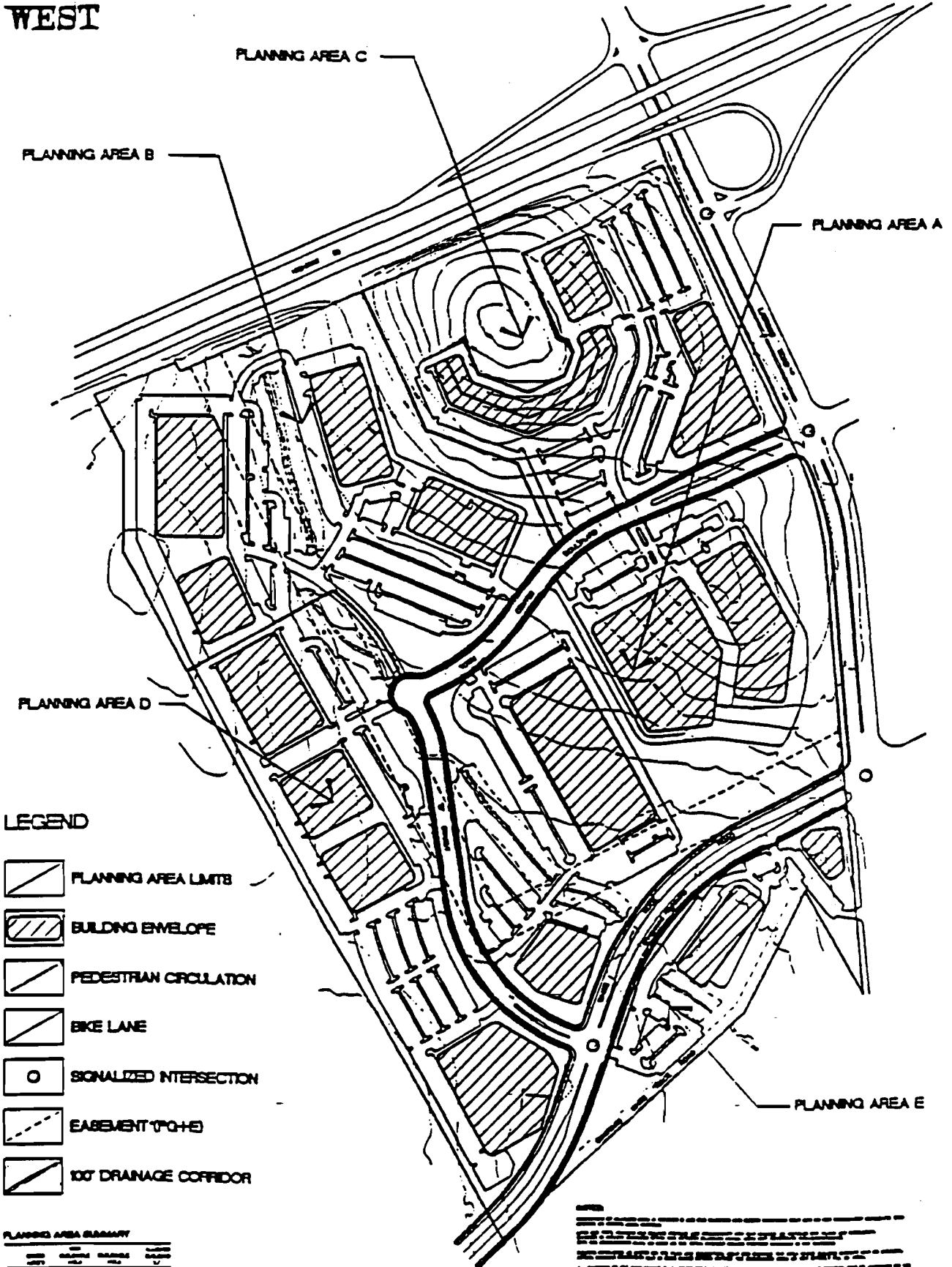

LEGEND

- PLANNING AREA LIMITS
- BUILDING ENVELOPE
- PEDESTRIAN CIRCULATION
- BIKE LANE
- SIGNALIZED INTERSECTION
- EASEMENT (PQ+E)
- 10' DRAINAGE CORRIDOR

PLANNING AREA BOUNDARY

PLANNING AREA	BOUNDARY	DESCRIPTION
A
B
C
D
E

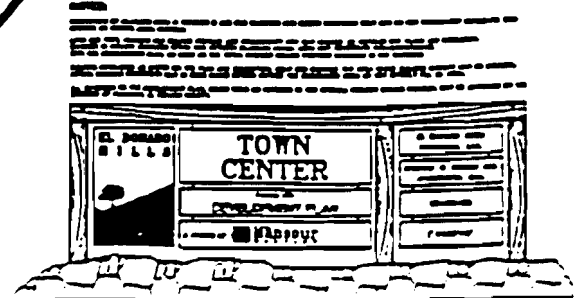

TOWN CENTER

LANDSCAPE CONCEPT

WEST

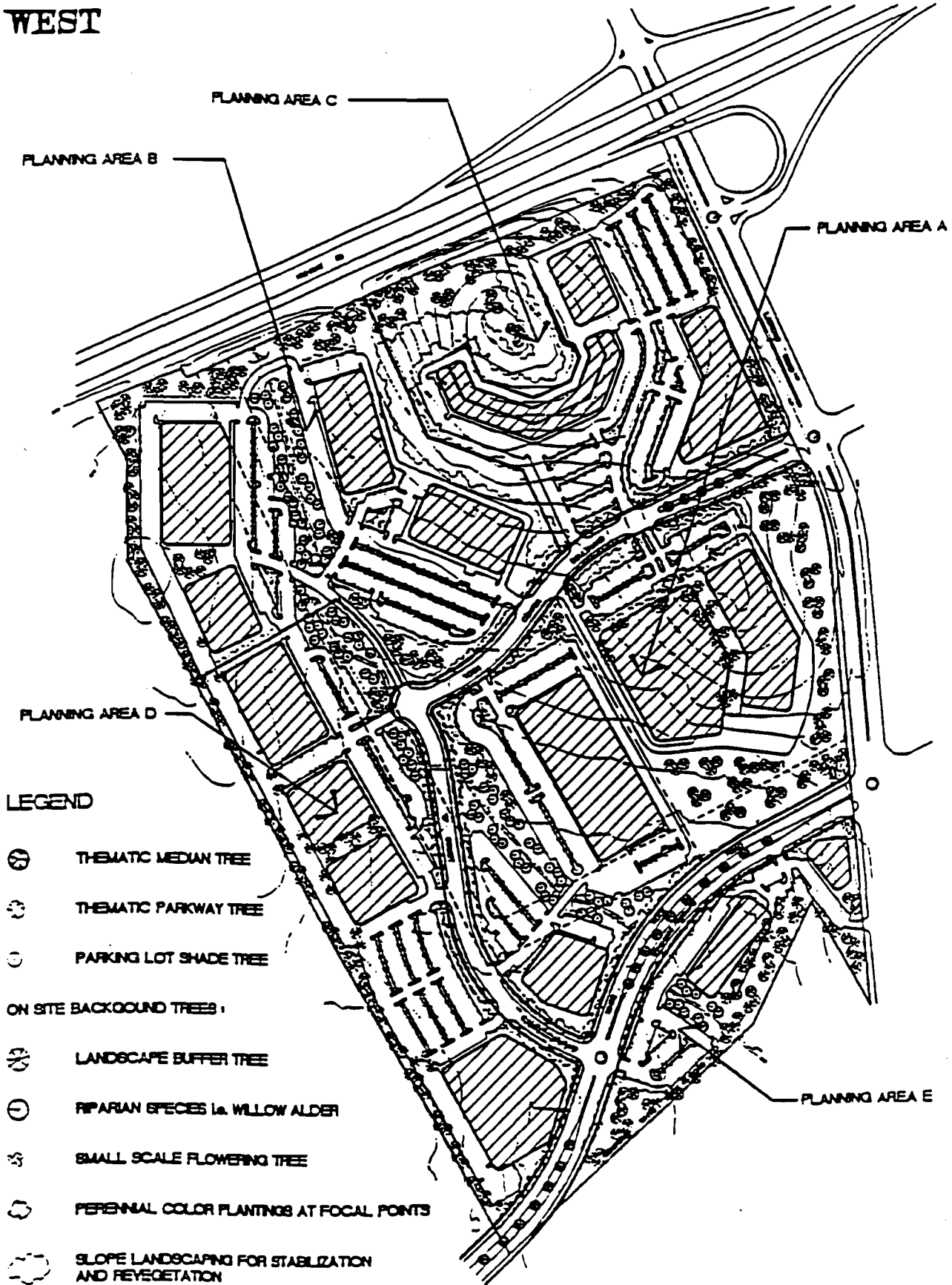

LEGEND

- ⊗ THEMATIC MEDIAN TREE
- ⊙ THEMATIC PARKWAY TREE
- PARKING LOT SHADE TREE
- ON SITE BACKGROUND TREES :
- ⊗ LANDSCAPE BUFFER TREE
- ⊙ RIPARIAN SPECIES (e.g. WILLOW ALDER)
- ⊙ SMALL SCALE FLOWERING TREE
- ⊙ PERENNIAL COLOR PLANTINGS AT FOCAL POINTS
- ⊙ SLOPE LANDSCAPING FOR STABILIZATION AND REVEGETATION

NOTE :
ALL PLANTINGS TO BE GROUPED IN HYDRO-ZONES FOR OPTIMAL WATER CONSERVATION

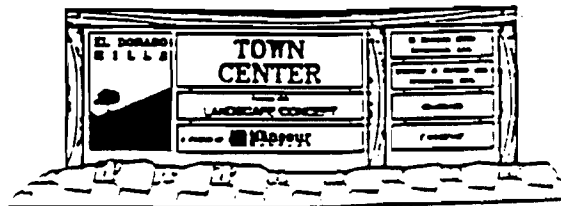

TOWN CENTER

GRADING CONCEPT

ST

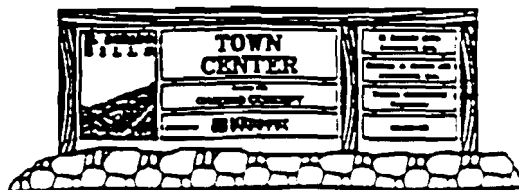
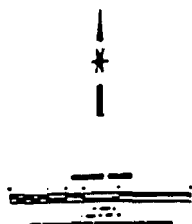
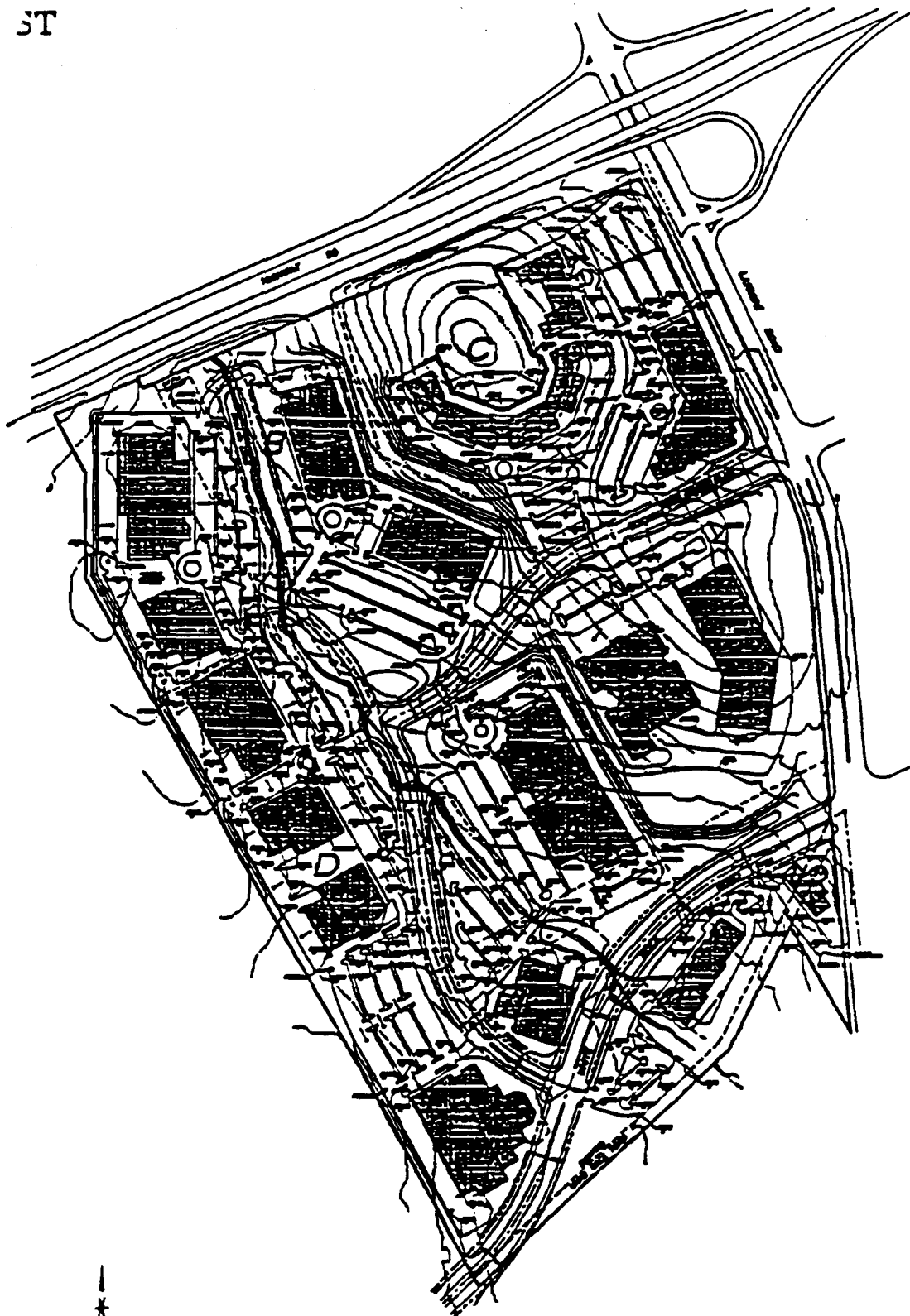

EL DORADO HILLS

EL DORADO COUNTY, CA

CONCEPTUAL NEIGHBORHOOD PLAN

Figure 10

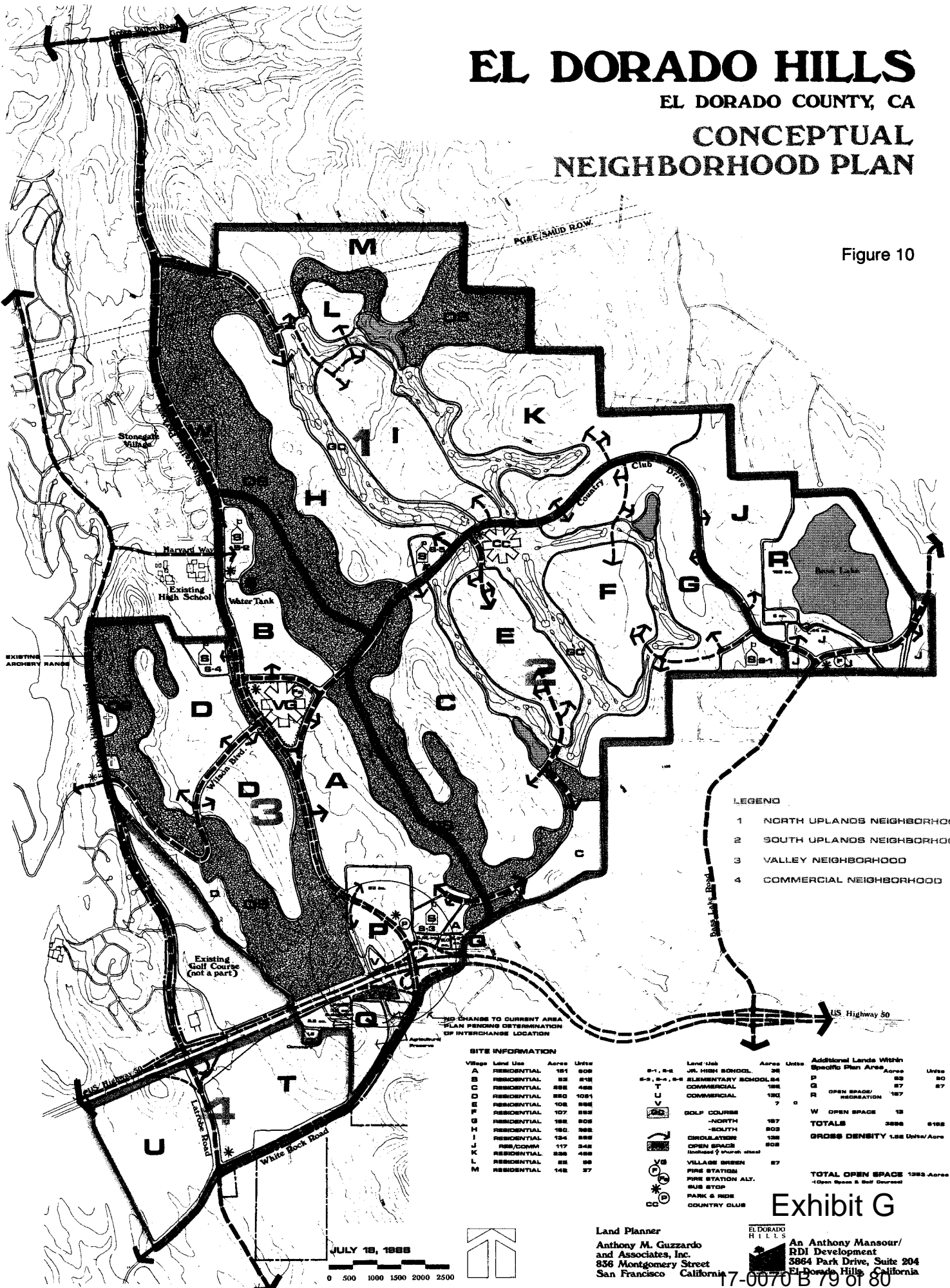

- LEGEND**
- 1 NORTH UPLANDS NEIGHBORHOOD
 - 2 SOUTH UPLANDS NEIGHBORHOOD
 - 3 VALLEY NEIGHBORHOOD
 - 4 COMMERCIAL NEIGHBORHOOD

SITE INFORMATION

Village	Land Use	Acres	Units
A	RESIDENTIAL	181	808
B	RESIDENTIAL	88	418
C	RESIDENTIAL	880	458
D	RESIDENTIAL	880	1081
E	RESIDENTIAL	108	888
F	RESIDENTIAL	107	888
G	RESIDENTIAL	188	808
H	RESIDENTIAL	182	888
I	RESIDENTIAL	134	888
J	RSS/COMM	117	348
K	RESIDENTIAL	838	488
L	RESIDENTIAL	88	88
M	RESIDENTIAL	148	87

Land Use	Acres	Units	Additional Lands Within Specific Plan Area	Acres	Units
S-1, R-4	JR. HIGH SCHOOL	38			
S-3, S-4, S-5	ELEMENTARY SCHOOL	84			
T	COMMERCIAL	188			
U	COMMERCIAL	182			
V	COMMERCIAL	7			
CC	GOLF COURSE				
	-NORTH	187			
	-SOUTH	808			
	CIRCULATOR	138			
	OPEN SPACE	808			
	(includes 7 church sites)				
VS	VILLAGE GREEN	87			
	FIRE STATION				
	FIRE STATION ALT.				
	BUS STOP				
	PARK & RIDE				
	COUNTRY CLUB				
			TOTALS	3888	8188
			TOTAL OPEN SPACE	1288	Acres
			<small>(Open Space & Golf Course)</small>		
			GROSS DENSITY	1.88 Units/Acre	

Exhibit G

Land Planner
 Anthony M. Guzzardo
 and Associates, Inc.
 856 Montgomery Street
 San Francisco, California

EL DORADO HILLS
 An Anthony Mansour/
 RDI Development
 3864 Park Drive, Suite 204
 El Dorado Hills, California

JULY 18, 1988
 0 500 1000 1500 2000 2500



EL DORADO HILLS

EL DORADO COUNTY, CA

LAND USE & CIRCULATION MAP (Illustrative) 2

Figure 9

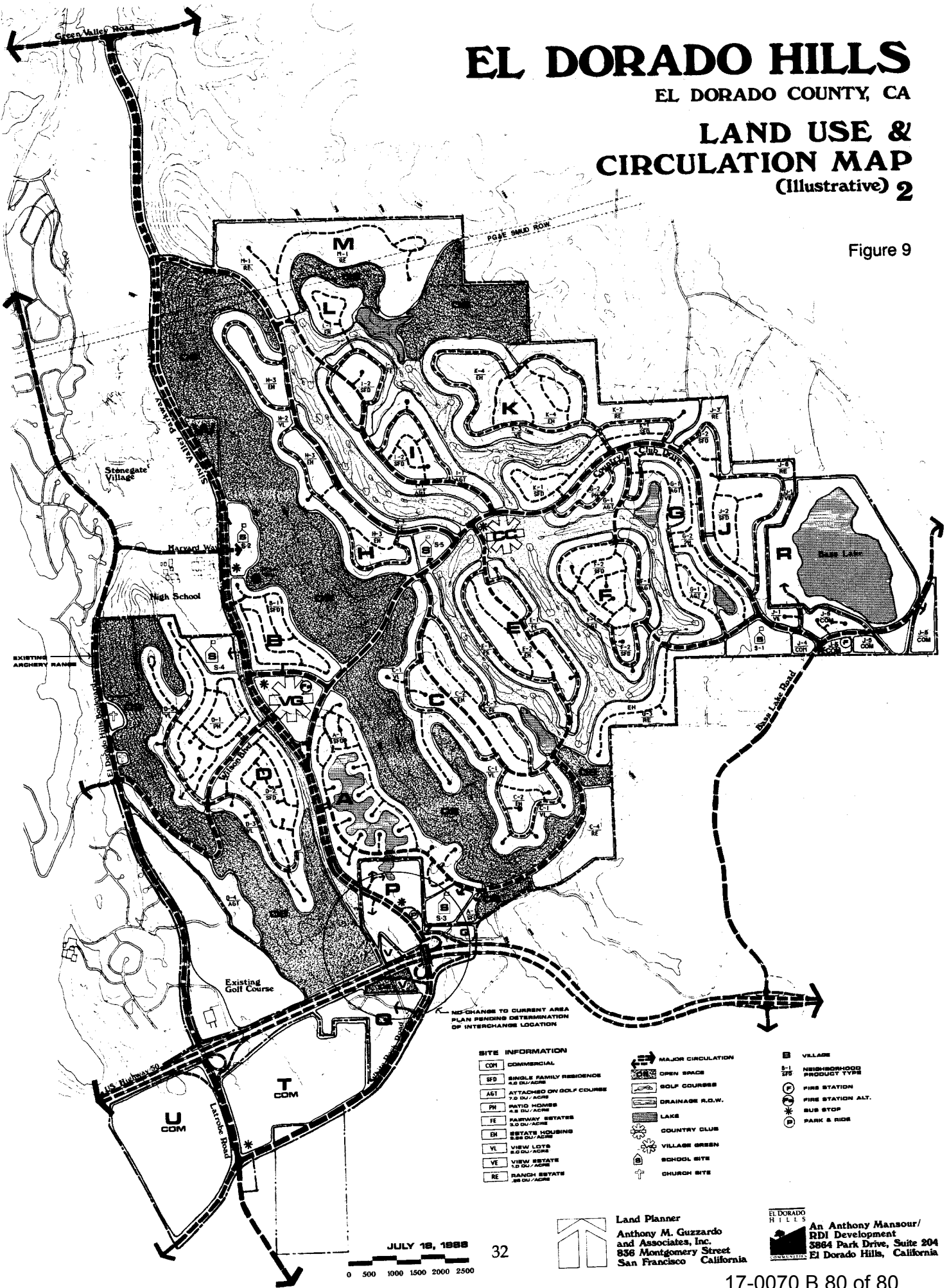

SITE INFORMATION

COM	COMMERCIAL
SFB	SINGLE FAMILY RESIDENCE 4.0 DU/ACRES
AG1	ATTACHED ON GOLF COURSE 7.0 DU/ACRES
PH	PATIO HOMES 4.0 DU/ACRES
FE	FARMWAY ESTATES 3.0 DU/ACRES
EN	ESTATE HOUSING 3.5 DU/ACRES
VL	VIEW LOTS 8.0 DU/ACRES
VE	VIEW ESTATE 1.0 DU/ACRES
RE	RANCH ESTATE 10 DU/ACRES

MAJOR CIRCULATION

[Symbol]	OPEN SPACE
[Symbol]	GOLF COURSE
[Symbol]	DRAINAGE R.O.W.
[Symbol]	LAKE
[Symbol]	COUNTRY CLUB
[Symbol]	VILLAGE GREEN
[Symbol]	SCHOOL SITE
[Symbol]	CHURCH SITE

VILLAGE

[Symbol]	NEIGHBORHOOD PRODUCT TYPE
[Symbol]	FIRE STATION
[Symbol]	FIRE STATION ALT.
[Symbol]	SUB STOP
[Symbol]	PARK & RIDE

JULY 18, 1988
0 500 1000 1500 2000 2500

Land Planner
Anthony M. Guzzardo
and Associates, Inc.
836 Montgomery Street
San Francisco

EL DORADO HILLS
An Anthony Mansour/
RDI Development
3864 Park Drive, Suite 204
El Dorado Hills, California