

SERRANO VILLAGE J5 & J6

TREE PRESERVATION AND PROTECTION PLAN

EL DORADO COUNTY

CALIFORNIA

SEPTEMBER 2016

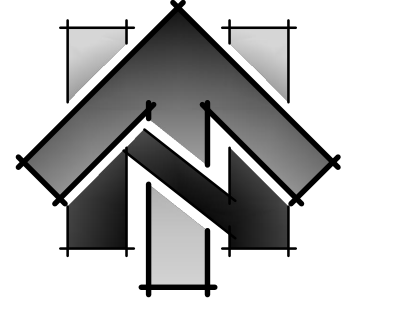

0 30' 60' 120'

SCALE IN FEET
MINOR CONTOUR INTERVAL = 1'
MAJOR CONTOUR INTERVAL = 5'



905 Silver Street, Suite 200, Folsom, CA 95630
916.366.3040 Fax 916.366.3303
R.E.Y. ENGINEERS, Inc.
Civil Engineers / Land Surveyors

OAK TREES
EXISTING OAK TREES: 541
TREES TO BE REMOVED: 376
REMAINING OAK TREES POST CONSTRUCTION: 165

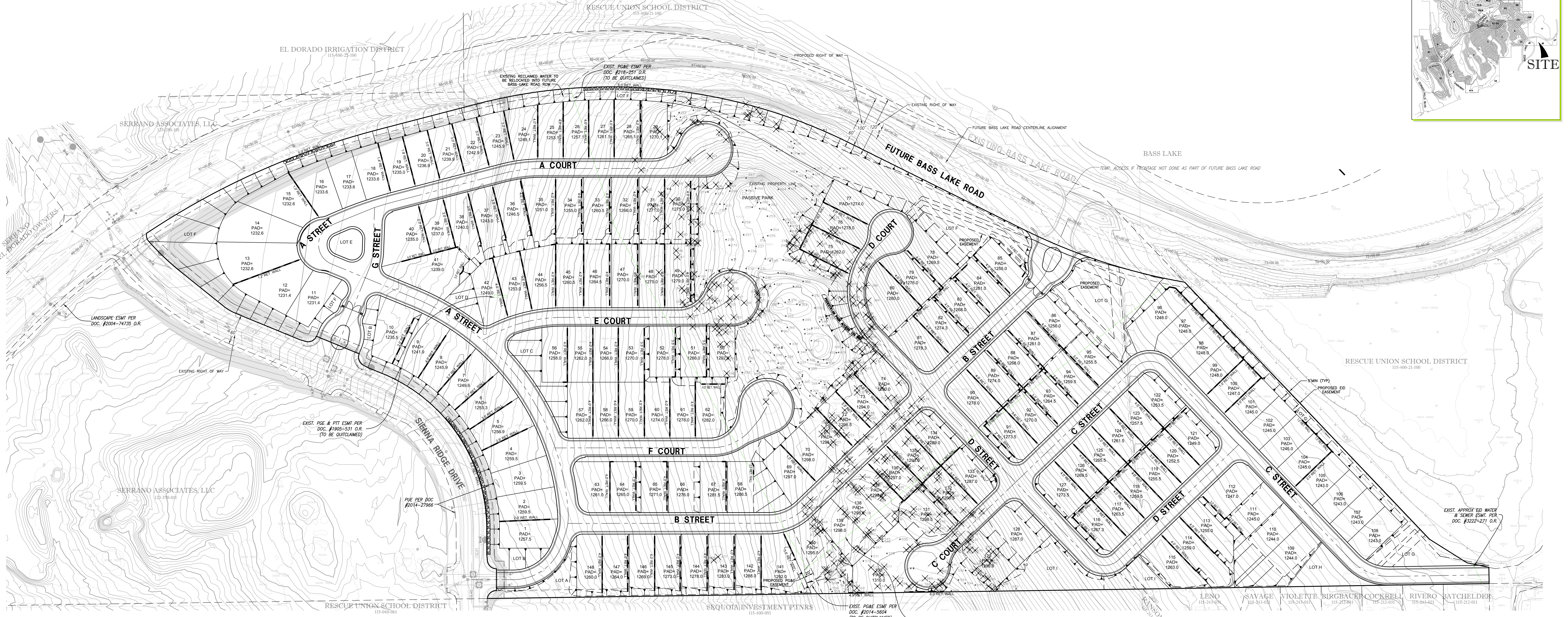
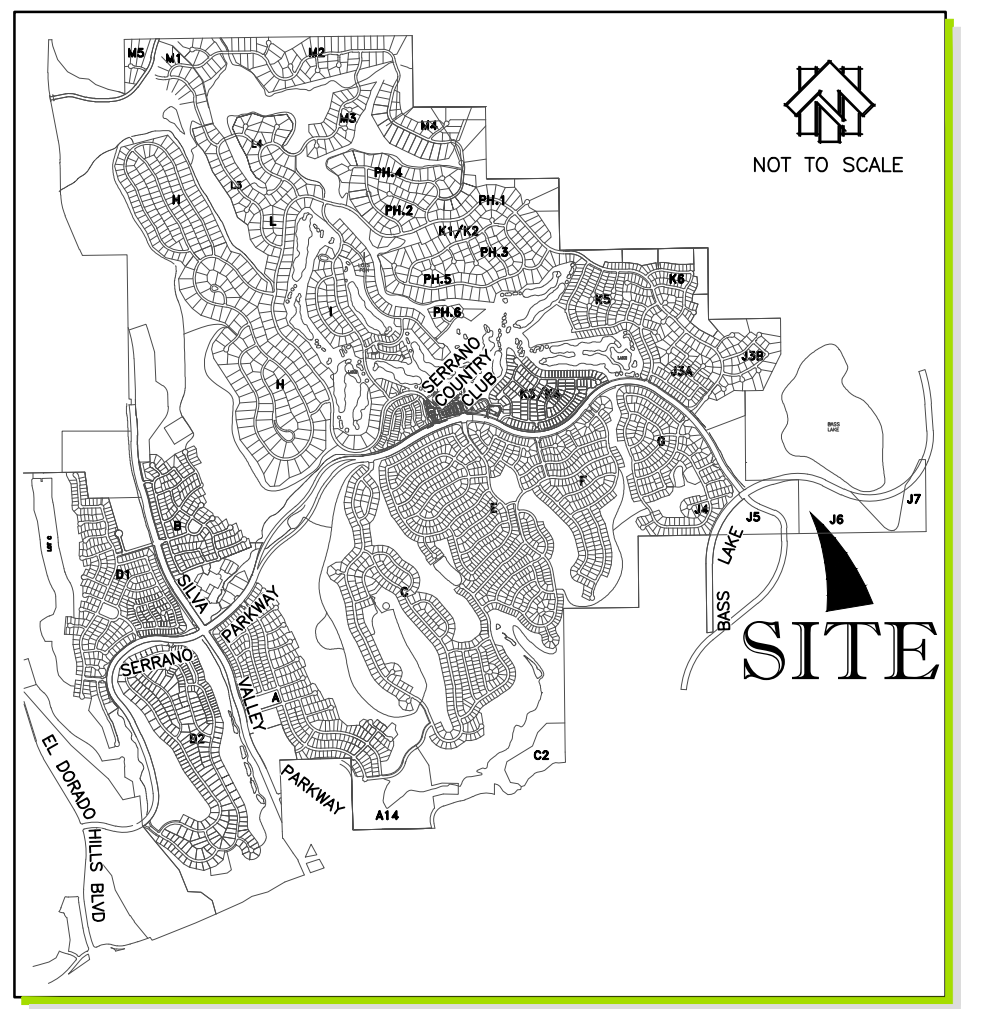

R:\SERRANO\J5 & J6\Drawings\Tree\17-0381 E 1 of 40.dwg - 17-0381 E 1 of 40.dwg - 17-0381 E 1 of 40.dwg - 17-0381 E 1 of 40.dwg - 17-0381 E 1 of 40.dwg

EXHIBIT M

**Modified Single-Unit Residential (R1) Development Standards for Serrano Village J5/J6
Tentative Subdivision**

Standard	Required by Zoning Ordinance	Proposed Modifications to Single-Unit Residential Development Standards	Notes
<i>Maximum Building Coverage (all buildings)</i>	35%	Maximum 65% coverage	
<i>Minimum Lot Area – Interior Lot</i>	6,000 sf	5,003 sf	
<i>Minimum Lot Width – Interior Lot</i>	60 feet	45 feet	
<i>Minimum Lot Area – Corner Lot</i>	7,500 sf	6,258 sf	
<i>Minimum Lot Width – Corner Lot</i>	75 feet	60 feet	
<i>Maximum Building Height</i>	40 feet	35 feet	
<i>Front Yard Setback</i>	20 feet	15 feet for living space 15 feet for side-load garage 20 feet for front-load garage	
<i>Rear Yard Setback</i>	15 feet	10 feet	
<i>Side Yard Setback</i>	5 feet	3 feet	
<i>Setback for AC/Pool Equipment</i>	Up to 50% encroachment, but not less than 3' from any property line	Side: 2.5' Rear: 2.5'	Shall be screened by solid fence
<i>Setback for Solid Fences and Walls over 40 inches tall</i>	Solid Fence Walls not to exceed 40" in height with in front yard	Front: 5' Side, and Rear: 0'	
<i>Setback for Open fences and walls (50% or more) and over 40 inches tall and less than 7' tall</i>	Front Yard with fence/wall 50% open or more, below 7' tall	Front, Side, and Rear: 0'	
<i>Setback for any structure such as a permanent BBQ or spa, not over 40 inches high</i>	Front: 20 feet Rear: 10 feet Side: 5 feet	Front: 0' Side and Rear: 2.5'	
<i>Setback for Pergola/ Trellis</i>	Side: 5' Rear: 15'	Side: 2.5' Rear: 2.5'	
<i>Setback for any structure over 30 inches high.</i>	Rear: 15'	Rear: 5'	Subject to Building Code
<i>Minimum Side and Rear Yard Setback: Swimming pool (underground)</i>	Side: 5 feet Rear: 5 feet	Side and Rear: 5'	As measured from edge of footing
<i>Minimum Side and Rear Yard Setback: Portable sheds (120 square feet or less)</i>	Side and Rear: 5'	Side and Rear: 5'	
<i>Setback for architectural extensions of the dwelling (uninhabitable space)</i>	Up to 50% encroachment, but not less than 3' to side property line	Side and Rear: 2.5'	
<i>Setback for chimneys – attached or detached</i>	Front and Rear: 3' into setbacks Side: 3' into setbacks, but remainder setback not less than 3'	Side: 3' Rear: 7'	

EXHIBIT N

NOTES:

- (E) UTILITIES NOT SHOWN FOR CLARITY
- (E) TREES #'S AND TREES TO BE REMOVED NOT SHOWN FOR CLARITY
- SOME EXISTING TOPOGRAPHIC FEATURES NOT SHOWN FOR CLARITY

ASSUMPTIONS

- 45 MPH POSTED LIMIT USED IN LIEU OF 85TH PERCENTILE SPEED FOR LANE REDUCTION CALCULATIONS
- 12' LANE WIDTH USED FOR LANE REDUCTION CALCULATIONS
- ADVANCED WARNING DISTANCE (D) FROM MUTCD SECTION 2C.05 - TABLE 2C-4 = 775FT, D/4=194FT
- LANE REDUCTION PER MUTCD SECTION 3B-14

LANE REDUCTION CALCULATIONS

LENGTH OF TAPER (L) = LANE WIDTH (W) x SPEED (S)
 $L = (12) \times (45)$
 $L = 540'$

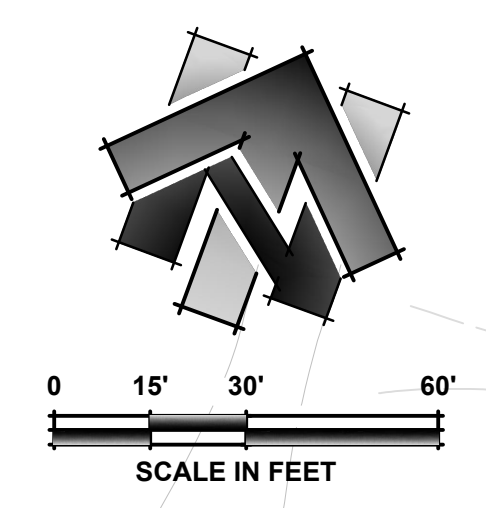
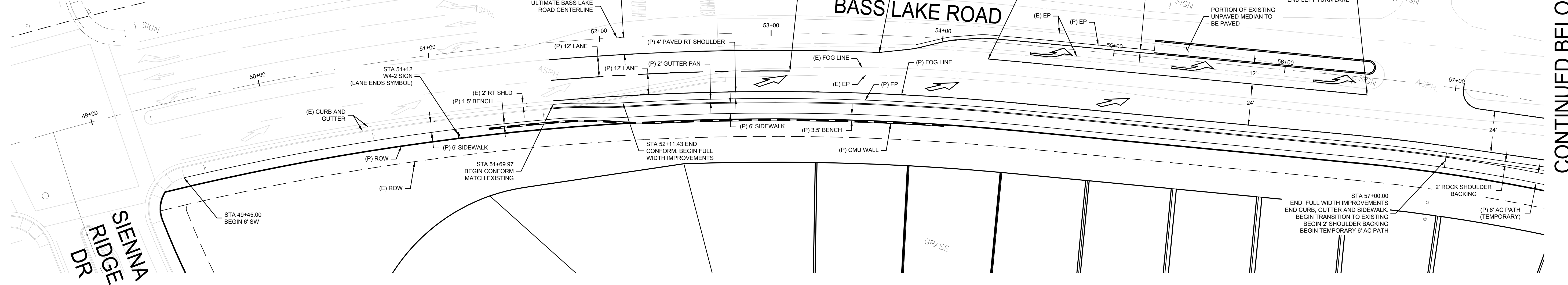

CONTINUED BELOW

CHECKED BY	DATE
NO. REVISION	DESCRIPTION

DRAWING SCALE
 HOR. SCALE: 1"=30'
 VERT. SCALE: 1"=6'

REY ENGINEERS, INC.
 Civil Engineers | Land Surveyors | LDAR
 995 S. Main Street, Suite 200, Fullerton, CA 92630
 Phone: (714) 366-3340 Fax: (714) 366-3333

PRELIM PLANIMETRICS FOR:
BLR FRONTAGE IMPROVEMENTS AT J6
CALIFORNIA
EL DORADO COUNTY

DRAWING INFO
 DATE: 01/28/17
 DRAFTER: [Signature]
 DESIGNER: [Signature]
 REVIEWER: [Signature]

PROJECT NO.
2677.216
 SHEET NO. **1** OF **1**

CONTINUED ABOVE

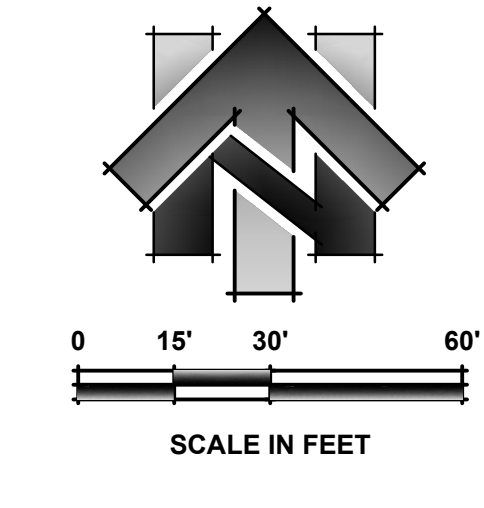
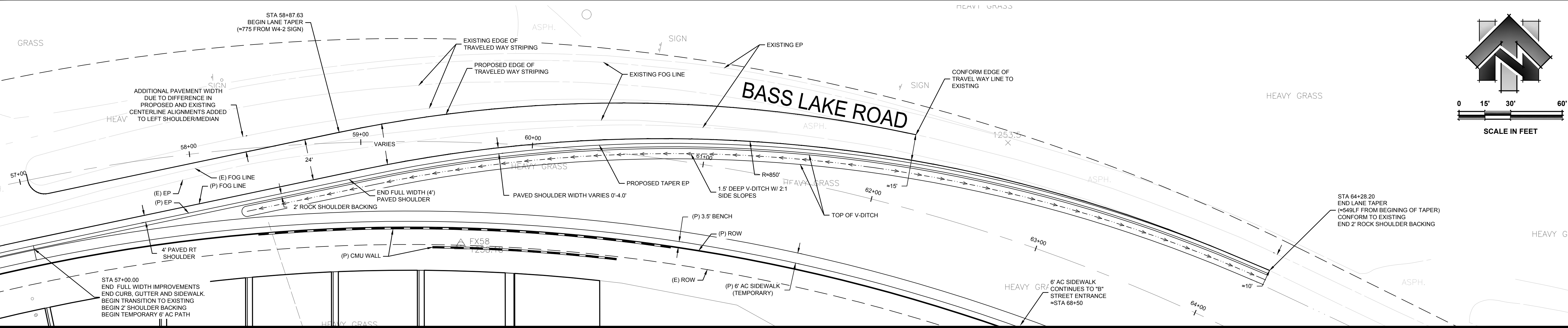

R:\2677.216 - Village J6 Grading Plans\1.0 - CAD Drawings\Grading Plans\2677.216 - 05-06 - Grading&Drainage.dwg Jan 06, 2017 - 12:03pm. abarnes

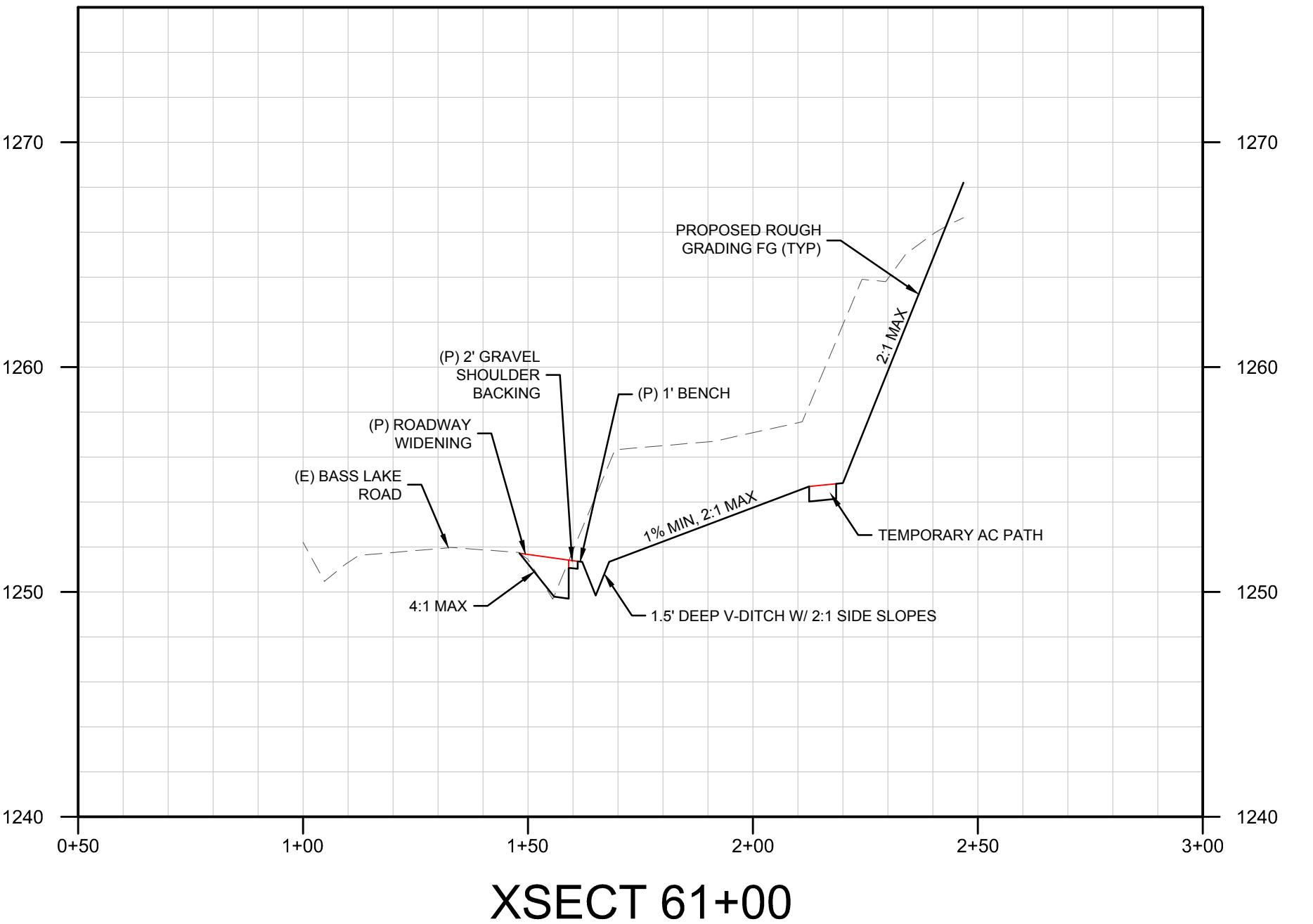
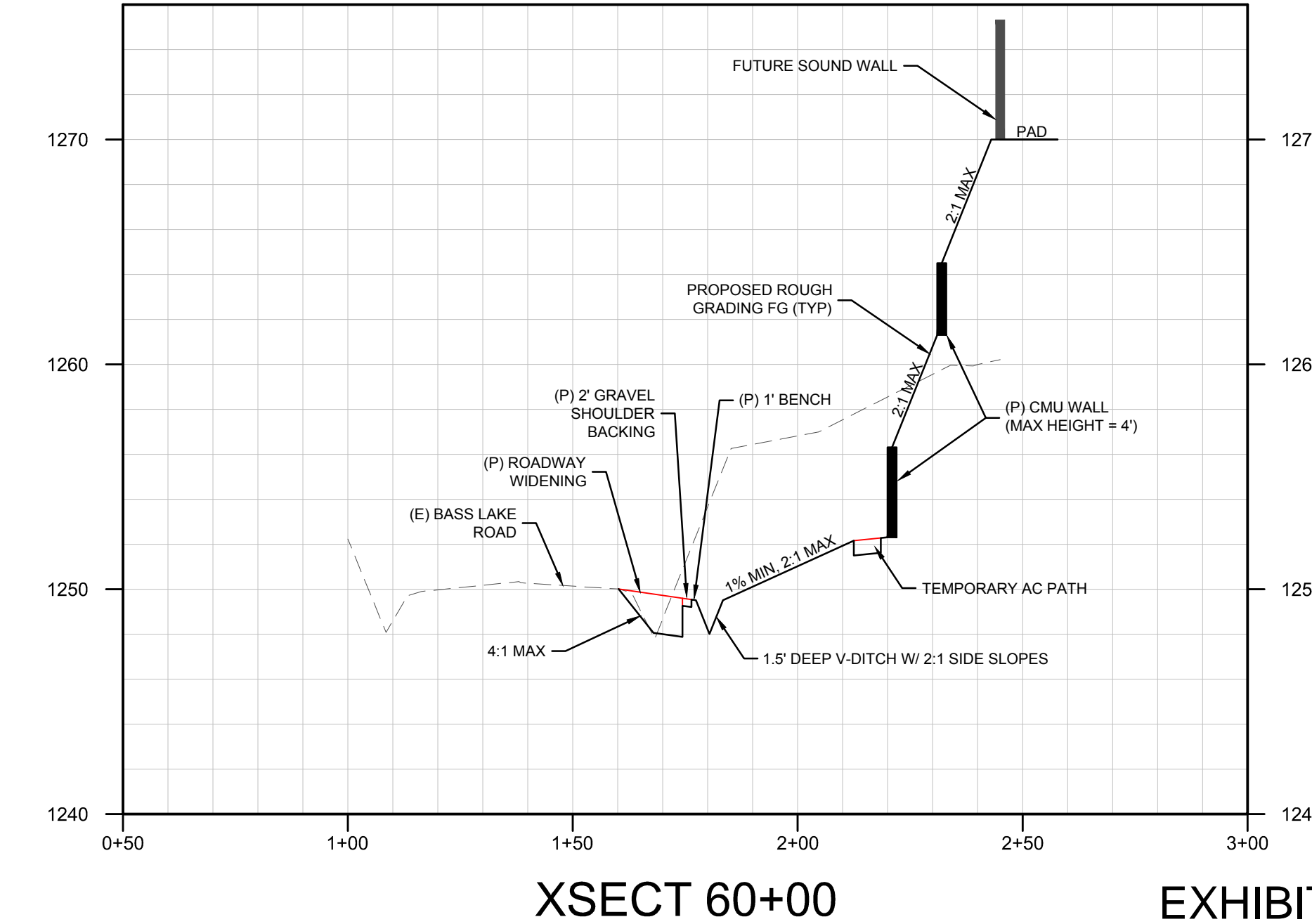
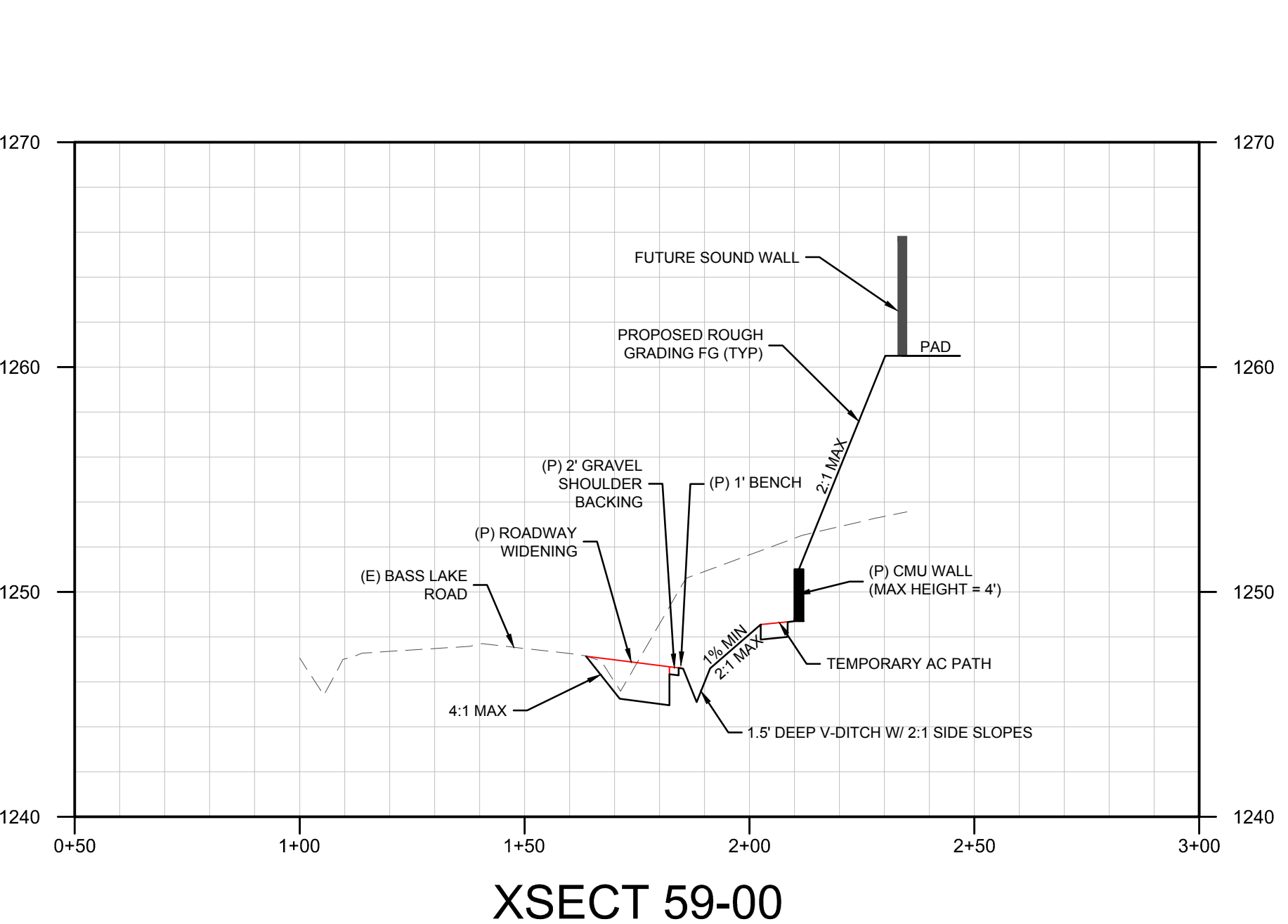

XSECT 59+00

XSECT 60+00

EXHIBIT O

XSECT 61+00



El Dorado Irrigation District

Letter No.: EEO 2016-0236

March 4, 2016

VIA FIRST-CLASS MAIL

Andrea Howard
Serrano Associates, LLC
4525 Serrano Parkway
El Dorado Hills, CA 95762

Subject: Facility Improvement Letter (FIL), Serrano Village J5 & J6
Assessor's Parcel No. 123-570-03, 04 (El Dorado Hills)

Dear Ms. Howard:

This letter is in response to your request dated January 27, 2016 and is valid for a period of three years. If a Facility Plan Report (FPR) for your project is not submitted to El Dorado Irrigation District (EID or District) within three years of the date of this letter, a new Facility Improvement Letter will be required.

Design drawings for your project must be in conformance with the District's *Water, Sewer and Recycled Water Design and Construction Standards*.

This project is a 160-lot residential subdivision on 35 acres. Water service, sewer service, recycled water service and fire hydrants are requested. The property is within the District boundary.

This letter is not a commitment to serve, but does address the location and approximate capacity of existing facilities that may be available to serve your project.

Water Supply

As of January 1, 2015, there were 5,094 equivalent dwelling units (EDUs) of water supply available in the Western/Eastern Water Supply Region. Your project as proposed on this date would require 179 EDUs of water supply.

Water Facilities

The El Dorado Hills Fire Department has determined that the minimum fire flow for this project is 1000 GPM for a 2-hour duration while maintaining a 20-psi residual pressure. According to the District's hydraulic model, the existing system can deliver the required fire flow. A 12-inch water line is located in Sienna Ridge Road and Serrano Parkway and several water lines exist in the Bridlewood Subdivision. The FPR should address the potential points of connection and the various fire flow requirements for the proposed Serrano projects in the area. There are existing water lines located along the eastern boundary of the property to be developed. You will be required to provide an unobstructed dedicated easement for these existing facilities in order to ensure that they will not be located on individual residential lots. The hydraulic grade line for the

existing water distribution facilities is 1,463 feet above mean sea level at static conditions and 1,460 feet above mean sea level during fire flow and maximum day demands.

The flow predicted above was developed using a computer model and is not an actual field flow test.

Recycled Water Facilities

There is an existing 16-inch recycled water line passing through the eastern portion of the property to be developed. You will be required to provide an unobstructed dedicated easement for these existing facilities in order to ensure that they will not be located on individual residential lots, or relocate a new recycled water line into a public road/easement with adequate space to maintain a transmission main of this size. The hydraulic grade line for the existing recycled water distribution facilities is approximately 1,395 feet above mean sea level. All new recycled water facilities required for this project should be addressed in the FPR.

The following items must be provided to and/or approved by the District before delivery of recycled water:

1. Non-Residential Sites:
 - a. A User Reclamation Plan (URP) prepared in accordance with the Recycled Water On-site Design and Construction Standards, and
 - b. On-site recycled water plans submitted with improvement plans.
2. Residential Sites:
 - a. An Engineer's Report as described in California Code of Regulations, Title 22, and
 - b. On-site recycled water landscape plans submitted for each individual home lot or, standard plans to be used with production homes.

The Engineer's Report and/or User Reclamation Plan will need to be approved before the District approves the project development plans. All costs for these studies, plans, and reports will be borne by the applicant.

Sewer Facilities

There is a 15-inch sewer line located near the southern property line in Birmingham Way. At this time there appears to be adequate capacity in this sewer line to serve the proposed project. In order to receive service from this line, an extension of facilities of adequate size must be constructed. All future sewer facilities will need to be coordinated with the off-site sewer portion of the Silver Springs project. This should be addressed in the FPR. Your project as proposed on this date would require 160 EDUs of sewer service.

Facility Plan Report

A Facility Plan Report (FPR) will be required for this project. The FPR shall address the expansion of the water, recycled water and sewer facilities and the specific fire flow requirements for all phases of the project. A meeting to discuss the content of the report will be required. Please contact this office to arrange the meeting. A preliminary utility plan, prepared by your engineer, must be brought to the meeting.

Two copies of the FPR will be required along with a \$2,000.00 deposit. You will be billed for actual time spent in review and processing of your FPR. Please submit the FPR and fee to our Customer Service Department. Enclosed is the FPR description and transmittal form for your use. The items listed under content in the description and the completed transmittal form must be bound in each copy of the FPR.

Easement Requirements

Proposed water lines, sewer lines and related facilities must be located within an easement accessible by conventional maintenance vehicles. When the water lines or sewer lines are within streets, they shall be located within the paved section of the roadway. No structures will be permitted within the easements of any existing or proposed facilities. The District must have unobstructed access to these easements at all times, and generally does not allow water or sewer facilities along lot lines.

Easements for any new District facilities constructed by this project must be granted to the District prior to District approval of water and/or sewer improvement plans, whether on-site or off-site. In addition, due to either nonexistent or prescriptive easements for some older facilities, any existing on-site District facilities that will remain in place after the development of this property must also have an easement granted to the District.

Environmental

The County is the lead agency for environmental review of this project per Section 15051 of the California Environmental Quality Act Guidelines (CEQA). The County's environmental document should include a review of both off-site and on-site water and sewer facilities that may be constructed by this project. You may be requested to submit a copy of the County's environmental document to the District if your project involves significant off-site facilities. If the County's environmental document does not address all water and sewer facilities and they are not exempt from environmental review, a supplemental environmental document will be required. This document would be prepared by a consultant. It could require several months to prepare and you would be responsible for its cost.

Summary

Service to this proposed development is contingent upon the following:

- The availability of uncommitted water supplies at the time service is requested;
- Approval of the County's environmental document by the District (if requested);
- Approval of a Facility Plan Report by the District;
- Executed grant documents for all required easements;
- Approval of an extension of facilities application by the District;
- Approval of facility improvement plans by the District;
- Construction by the developer of all onsite and offsite proposed water and sewer facilities;
- Acceptance of these facilities by the District; and
- Payment of all District connection costs.



Services shall be provided in accordance with El Dorado Irrigation District Board Policies and Administrative Regulations, as amended from time-to-time. As they relate to conditions of and fees for extension of service, District Administrative Regulations will apply as of the date of a fully executed Extension of Facilities Agreement.

If you have any questions, please contact me at (530) 642-4135.

Sincerely,

A handwritten signature in blue ink, appearing to read 'Michael J. Brink', is written over a horizontal line.

Michael J. Brink, P.E.
Supervising Senior Civil Engineer

MB/MM:at

Enclosures: System Map
FPR Guidelines and transmittal

cc w/ System Map:

Marshall Cox – Fire Marshal
El Dorado Hills Fire Department
Via email - mcox@edhfire.com

Roger Trout, Director
El Dorado County Development Services Department
Via email - roger.trout@edcgov.us

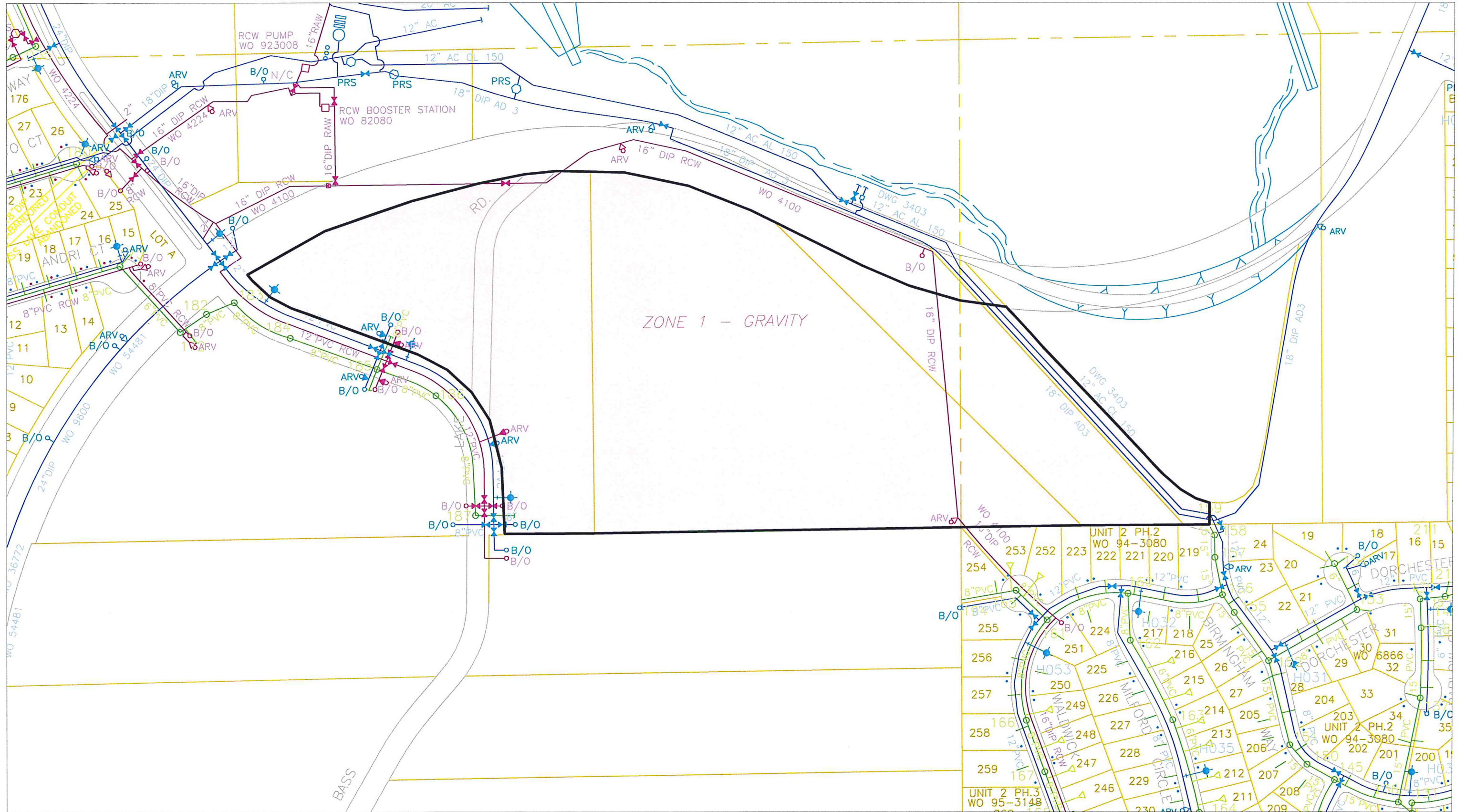

El Dorado Irrigation District
System Map

WARNING: For schematic purposes only.
Exact pipe location must be
field verified.

- WATERLINE
- - - - - SEWERLINE



Scale: 1" = 250'

DATE: March 2, 2016

Serrano Village J5 & J6

17-0881 E 3 of 40 -03,04

SERRANO VILLAGE J5 & J6

TENTATIVE WATER, RECLAIMED WATER & SEWER PLAN

EL DORADO COUNTY SEPTEMBER 2016 CALIFORNIA

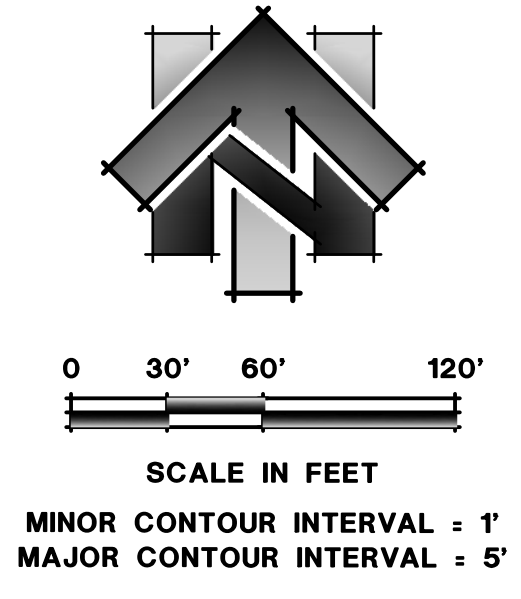

SERRANO
 905 Sutter Street, Suite 200, Folsom, CA 95630
 P: 916.366.3340 Fax: 916.366.3303
 R.E.Y. ENGINEERS, Inc.
 Civil Engineers / Land Surveyors

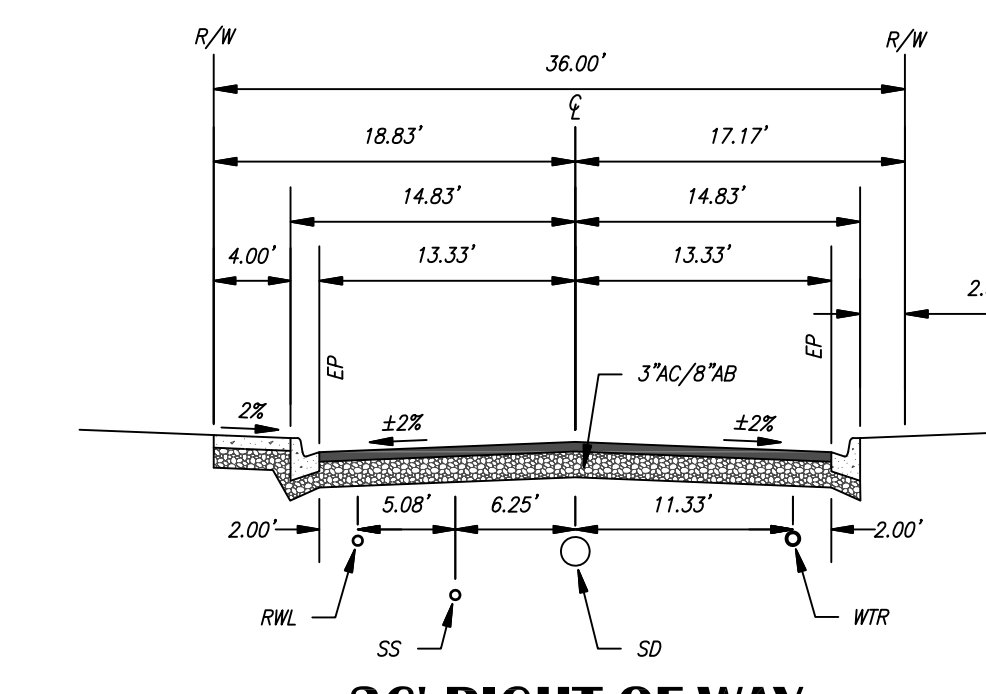
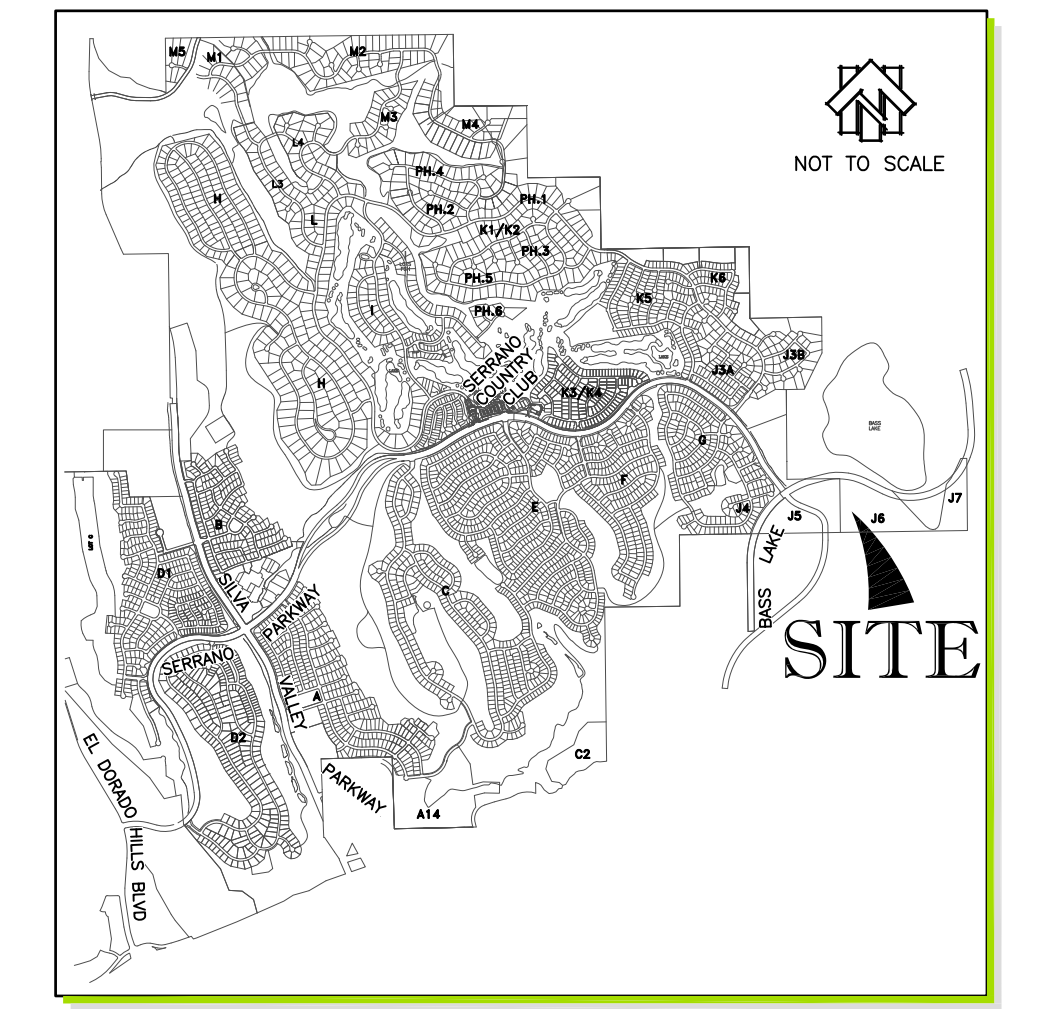

36' RIGHT-OF-WAY
 SCALE: N.T.S.
 "A" COURT
 "C" STREET - STA. 9+37.84 TO STA. 15+33.79
 "C" COURT
 "D" COURT
 "E" COURT
 "F" COURT

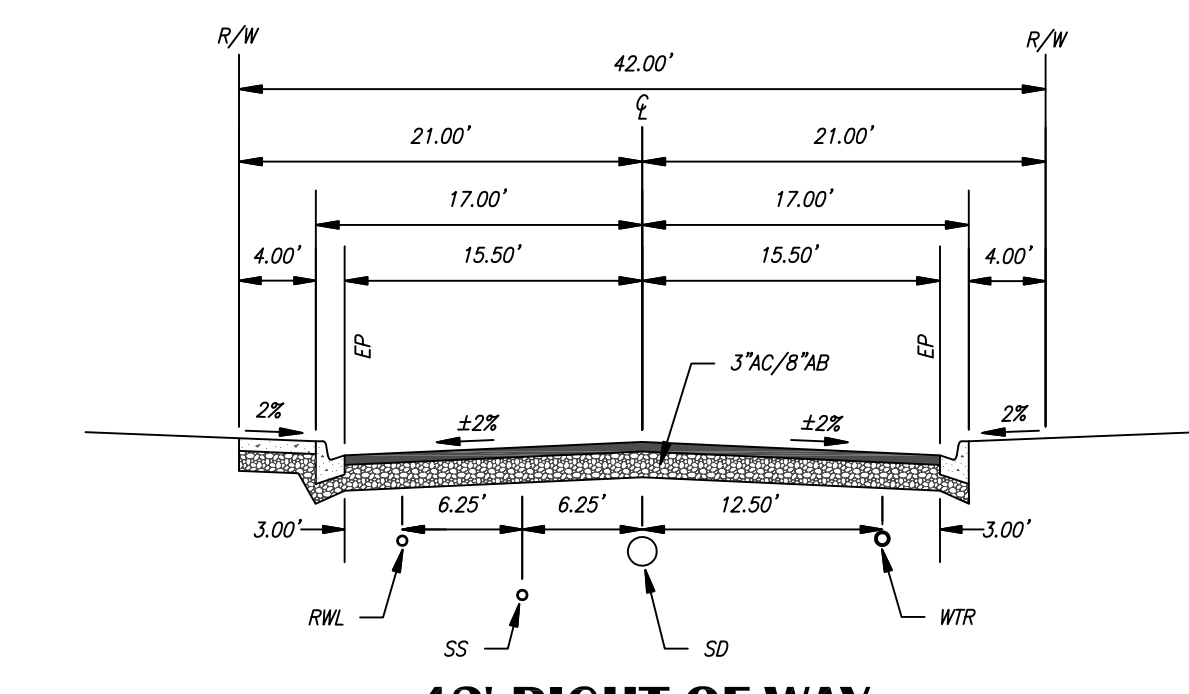

42' RIGHT-OF-WAY
 SCALE: N.T.S.
 "A" STREET
 "B" STREET
 "C" STREET - STA. 3+38.44 TO STA. 6+64.44
 "D" STREET - STA. 4+83.30 TO STA. 9+74.50
 "G" STREET

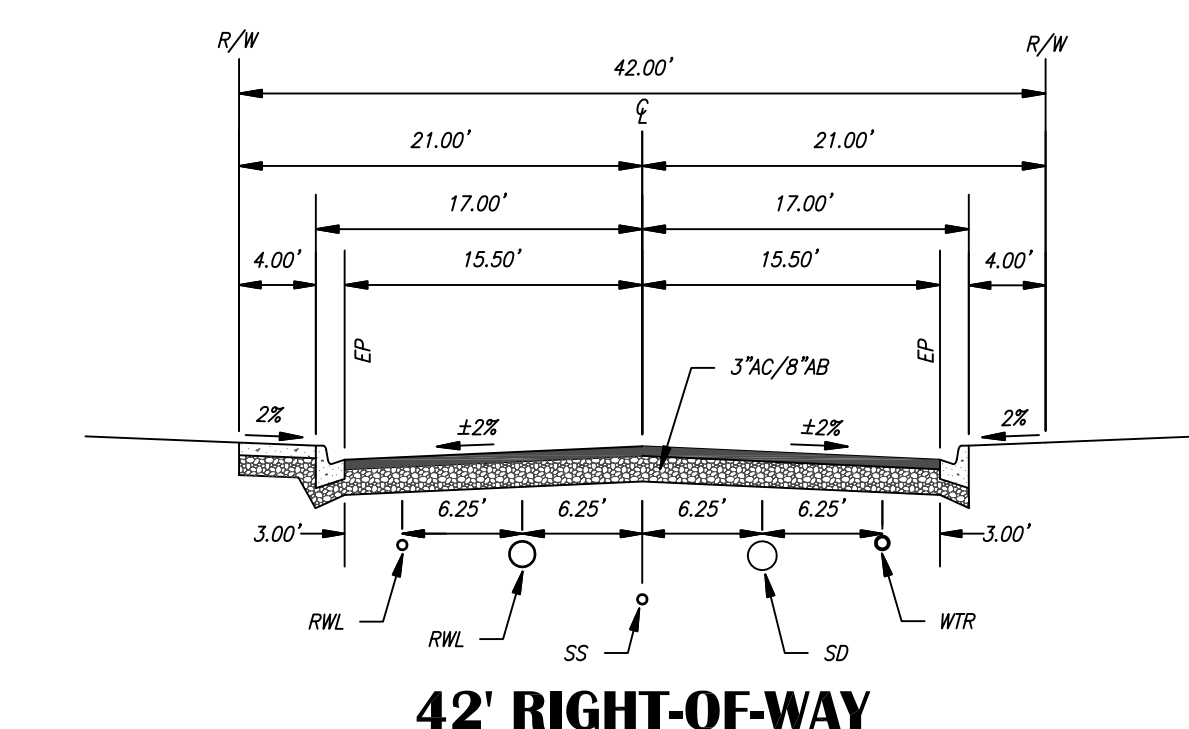

42' RIGHT-OF-WAY
 SCALE: N.T.S.
 "C" STREET - STA. 6+64.44 TO STA. 9+37.84
 "D" STREET - STA. 9+74.50 TO STA. 13+32.70

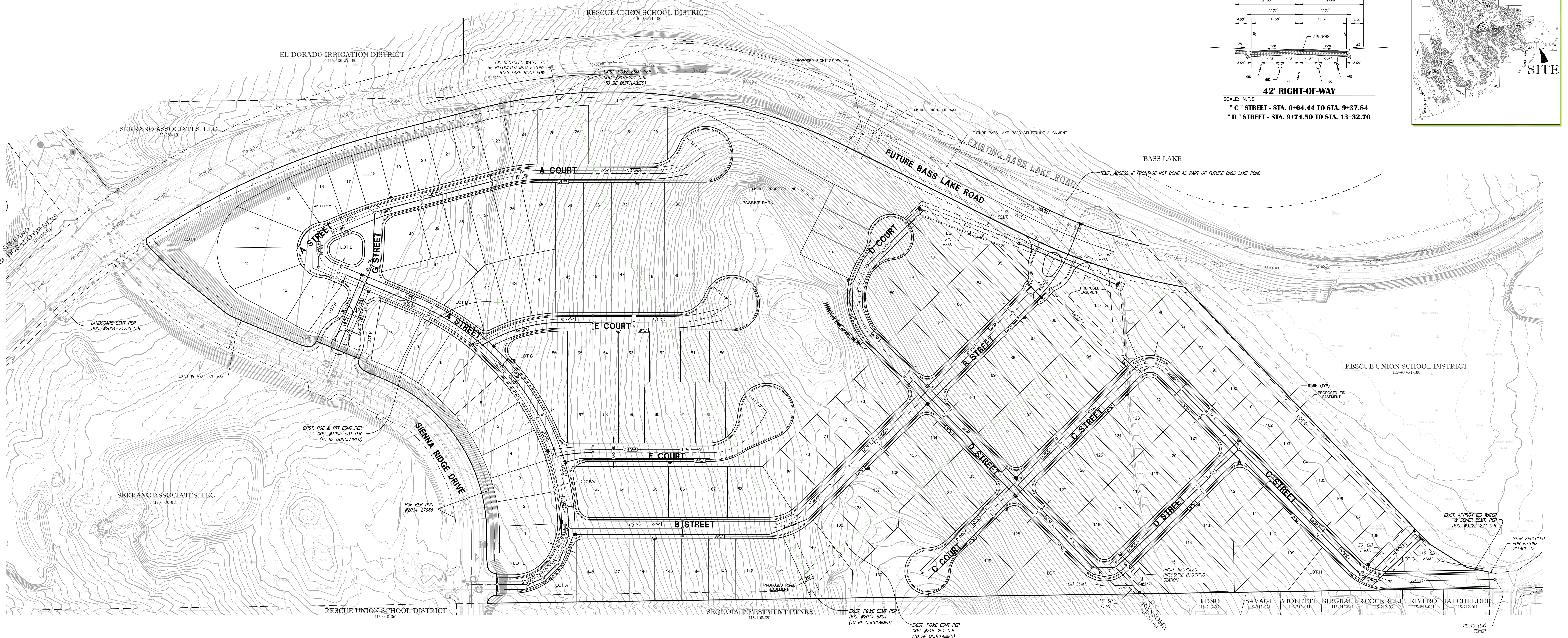

EXHIBIT Q

R:\SERRANO_VILLAGE\J5 & J6\Drawings\17-0381 E 9 of 40.dwg - 17-0381 E 9 of 40.dwg - 17-0381 E 9 of 40.dwg - 17-0381 E 9 of 40.dwg - 17-0381 E 9 of 40.dwg

SERRANO VILLAGE J5 & J6

EXISTING / PROPOSED DRAINAGE EXHIBIT

EL DORADO COUNTY

SEPTEMBER 2016

CALIFORNIA

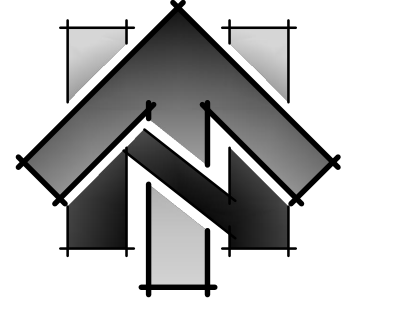

0 30' 60' 120'

SCALE IN FEET

MINOR CONTOUR INTERVAL = 1'

MAJOR CONTOUR INTERVAL = 5'



R.E.Y. ENGINEERS, Inc.
Civil Engineers / Land Surveyors

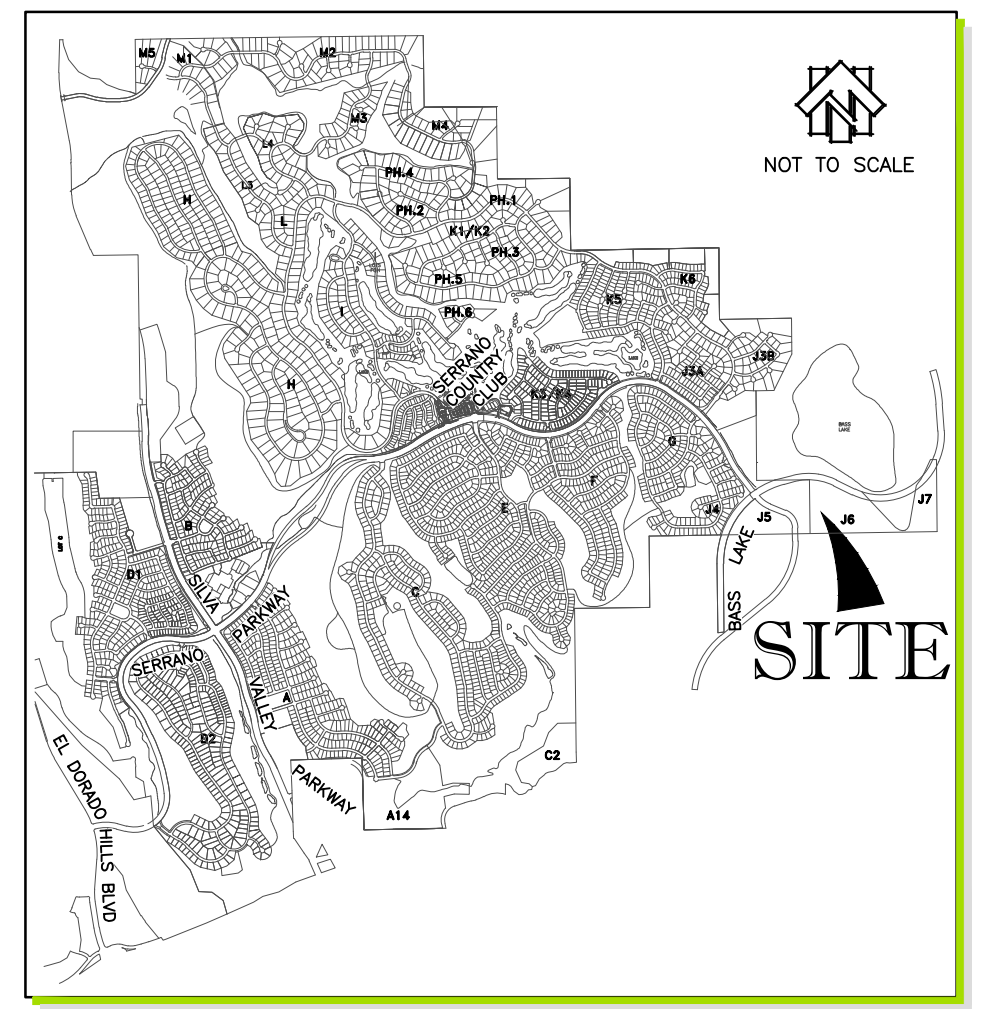

LEGEND:

- OVERLAND RELEASE
- EXISTING DRAINAGE PATTERN
- PROPOSED DRAINAGE PATTERN

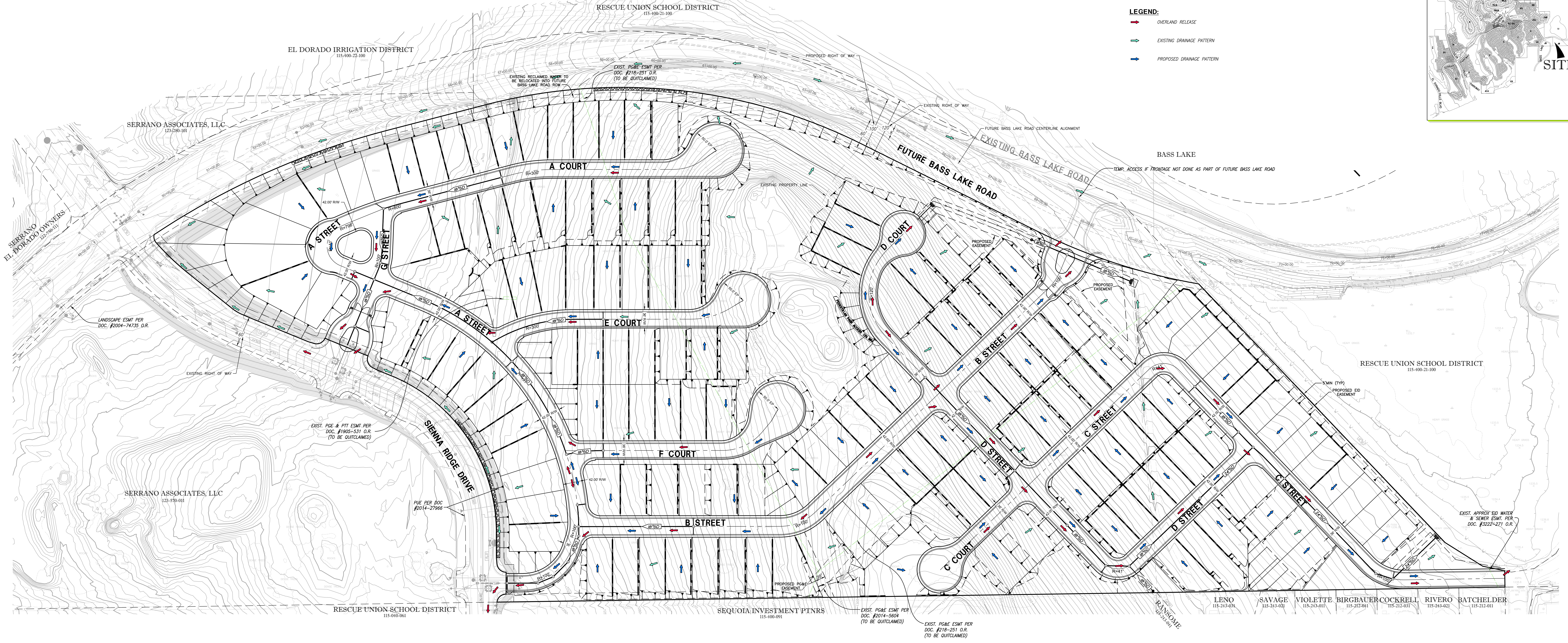

17-0381 E 11 of 40

Environmental Noise Analysis

Serrano Village J5 & J6

El Dorado County, California

BAC Job # 2013-070

Prepared For:

Parker Development Company

Attn: Mr. Tom Howard
4525 Serrano Parkway
El Dorado Hills, CA 95762

Prepared By:

Bollard Acoustical Consultants, Inc.



Paul Bollard, President

November 22, 2016



EXHIBIT S

17-0381 F 12 of 40

Introduction

The Serrano Village J5 & J6 project is located in the western portion of El Dorado County, in the unincorporated community of El Dorado Hills. Land uses in the project vicinity include single-family residential to the northwest and southeast, Bass Lake to the north, and rural residential to the south. Village J6 proposes a 148-lot subdivision while Village J5 would consist of commercial uses.

Traffic noise emanating from Bass Lake Road, as well as noise from the proposed Village J5 commercial uses are considered to be potentially significant noise sources affecting the proposed residential uses of Village J6. As a result, the project developer has retained Bollard Acoustical Consultants, Inc. (BAC) to prepare this analysis. The project area, residential site plan, and commercial site plan are shown in Figures 1, 2, and 3, respectively.

El Dorado County Noise Standards

The Noise Element of the El Dorado County General Plan contains policies to ensure that County residents are not subjected to noise beyond acceptable levels.

Policy 6.5.1.1 of the County Noise Element requires an acoustical analysis for new residential developments located in potentially noise-impacted areas.

Policy 6.5.1.2 states that where proposed non-transportation noise sources are likely to produce noise levels exceeding the performance standards of Table 1 at existing or planned residential uses, an acoustical analysis shall be required as part of the environmental review process so that noise mitigation may be included in the project design.

Policy 6.5.1.3 states that where noise mitigation measures are required to achieve the County's exterior noise standards, the emphasis of such measures shall be placed upon site planning and project design. The use of noise barriers shall be considered a means of achieving the noise standards only after all other practical design-related noise mitigation measures have been integrated into the project and the noise barriers are not incompatible with the surroundings.

Policy 6.5.1.7 states that noise created by new non-transportation noise sources shall be mitigated so as not to exceed any of the noise level standards of Table 1, as measured immediately within the property line of the receiving property.

Policy 6.5.1.8 establishes 45 and 60 dB L_{dn} as being acceptable interior and exterior noise levels, respectively, for new residential uses affected by traffic noise sources. Where it is not possible to reduce noise in outdoor activity areas to 60 dB L_{dn} or less using a practical application of the best available noise reduction measures, an exterior noise level of up to 65 dB L_{dn} may be allowed provided that available exterior noise reduction measures have been implemented and interior noise levels are in compliance with the 45 dB L_{dn} standard.

Figure 1

Serrano Village J5 & J6 - El Dorado County, California
Project Area and Traffic Noise Measurement Locations

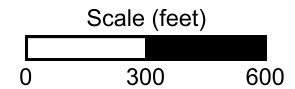



Figure 2

Serrano Village J5 & J6 - El Dorado County, California Project Site Plan, Recommended Noise Barrier Locations, and 60 dB Ldn Traffic Noise Contour



Legend

-  Future (2035) 60 dB Ldn Traffic Noise Contour
-  Recommended 6-foot Noise Barrier Location

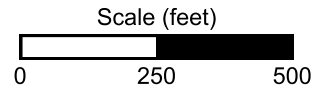

Figure 3
 Serrano Village J5 & J6 - El Dorado County, California
 Serrano J5 Commercial Center Site Plan



Table 1
Performance Standards for Non-Transportation Noise Sources
El Dorado County Noise Element – Community Areas

Noise Level Descriptor	Daytime (7 a.m. - 7 p.m.)	Evening (7 p.m. - 10 p.m.)	Nighttime (10 p.m. - 7 a.m.)
Hourly L_{eq} , dB	55 dB	50 dB	45 dB
Maximum Level, dB	70 dB	60 dB	55 dB

Note: Each of the noise levels specified above should be lowered by 5 dB for simple tone noises, noises consisting primarily of speech or music, or for recurring impulsive noises.

Please refer to Appendix A for definitions of acoustical terminology.

Existing Ambient Noise Environment

The noise environment in the project vicinity is primarily defined by traffic noise emanating from Bass Lake Road. To quantify existing ambient noise levels in the project area, BAC conducted long-term and short-term noise surveys at the locations shown on Figure 1 on August 7-9, 2013. Larson-Davis Laboratories (LDL) 820 precision integrating sound level meters were used to complete the noise level measurement survey. The meters were calibrated before use with a LDL Model CAL200 calibrator to ensure the accuracy of the measurements.

The equipment used meets all pertinent specifications of the American National Standards Institute for Type 1 sound level meters (ANSI S1.4). The noise level measurement results are summarized below in Table 2. The detailed long-term monitoring results conducted at Site A are provided in Appendices B and C.

Table 2
Summary of Ambient Noise Level Measurements
Serrano Village J5 & J6 Residential Development – August 7-9, 2013

Site	Date	Daytime				Nighttime		
		L_{dn}	L_{eq}	L_{50}	L_{max}	L_{eq}	L_{50}	L_{max}
1 ¹	August 7, 2013 – 2:55 PM	--	59	--	71	--	--	--
2 ¹	August 7, 2013 – 2:30 PM	--	63	--	82	--	--	--
A ²	August 7-8, 2013	63	59	55	69-82	56	40	65-75
	August 8-9, 2013	63	58	55	68-77	56	41	64-73

Notes:

¹ Short-term noise level measurement location, 15 minute duration.

² Long-term noise level measurement location, 48 hour duration.

Source: Bollard Acoustical Consultants, Inc.

Evaluation of Future Bass Lake Road Traffic Noise Levels

Traffic Noise Prediction Methodology

The Federal Highway Administration Highway Traffic Noise Prediction Model (FHWA-RD-77-108) with the Calveno vehicle noise emission curves was used to predict traffic noise levels at the project site.

Traffic Noise Prediction Model Calibration

The FHWA Model provides reasonably accurate traffic noise predictions under “ideal” roadway conditions. Ideal conditions are generally considered to be long straight roadway segments with uniform vehicle speeds, a flat roadway surface, good pavement conditions, a statistically large volume of traffic, and an unimpeded view of the roadway from the receiver location. Such conditions did not appear to be in effect at this project site. As a result, Bollard Acoustical Consultants, Inc. conducted a careful calibration of the FHWA Model through site-specific traffic noise level measurements and concurrent traffic counts.

This calibration process was performed at two locations on the project site on August 7th, 2013. The traffic noise measurement locations, Sites 1 and 2, are shown in Figure 1. The detailed results of this procedure are provided in Appendix D. The FHWA Model was found to reasonably predict traffic noise levels at the measurement site. As a result, no calibration adjustment was applied to the FHWA Model for the prediction of future traffic noise levels at the project site.

Predicted Future Exterior Traffic Noise Levels at Outdoor Activity Areas

The FHWA Model was used with future traffic data to predict future traffic noise levels at the proposed outdoor activity areas of the project residences which are located adjacent to Bass Lake Road. Future traffic volume forecasts for Bass Lake Road were obtained from El Dorado County Traffic Model. The FHWA Model inputs and predicted future traffic noise levels at the project site are shown in Appendix E. The predicted future traffic noise levels are summarized below in Table 3.

Table 3
Predicted Future Traffic Noise Levels at Lots Nearest to Bass Lake Road
Serrano Village J5 & J6 – El Dorado County, California

Roadway	Predicted L _{dn} (dB) at Proposed Outdoor Activity Areas					
	Lot 15	Lot 23	Lot 28	Lot 77	Lot 96	Lot 101
Bass Lake Road	64	65	65	62	64	58

Note: A complete listing of FHWA Model inputs and results are provided in Appendix E.

The Table 2 data indicate that future traffic noise levels within the backyards of the nearest to Bass Lake Road will be exposed to the future traffic noise levels in the County's conditionally acceptable range of 60-65 dB L_{dn}. Because the predicted exterior levels along Bass Lake Road are within this conditionally acceptable range, a more specific analysis of potential noise impacts at the residences located adjacent to Bass Lake Road was prepared.

Traffic Noise Barrier Analysis

An analysis of noise barrier effectiveness was performed for this project and is summarized below in Table 4 for representative backyard areas. Proposed grading plans were reviewed to ensure that proposed site topography was included in the barrier analysis. The detailed results of the noise barrier effectiveness are provided as Appendix F.

Table 4
Barrier Analysis Results
Serrano Village J5 & J6 - El Dorado County, California

Barrier Height (feet)	Predicted L _{dn} (dB) at Proposed Outdoor Activity Areas				
	Lot 15	Lot 23	Lot 28	Lot 77	Lot 96
No barrier	64	65	65	62	64
5	56	57	56	53	59
6	55	56	55	52	58
7	54	55	54	51	57
8	53	54	53	50	56

Note: A complete listing of FHWA Model Noise Barrier Effectiveness inputs and results are provided in Appendix F.

As shown above in Table 4, the barrier analysis results indicate that a 5-foot wall constructed at the locations shown in Figure 2 would be adequate to achieve compliance with the County's exterior noise standard (60 dB L_{dn}).

The model result indicates that a 5-foot tall barrier would be adequate is based on the typical assumption that the receiver is located in the middle of the backyard area. If the receiver is located closer to the house (further from the road), the barrier would be more effective. However, at backyard receiver locations closer to the wall, the wall would be less effective as a standing individual could potentially see the roadway over the top of the barrier. To provide adequate noise attenuation, a solid barrier height of at least 6 feet is recommended.

Interior Noise Levels within Residences Located Adjacent to Bass Lake Road

With construction of the required Bass Lake Road noise barrier, future traffic noise levels are not predicted to exceed 60 dB L_{dn} at the exterior first-floor facades of residences constructed along Bass Lake Road. Due to reduced ground absorption at elevated positions, and lack of shielding by barriers at upper floor areas, second-floor facade exterior noise levels are predicted

to be approximately 67 dB L_{dn}. Based on this level, a building facade noise reduction of 22 dB or less would be required to achieve an interior noise level of 45 dB L_{dn} within second-floor rooms, and 15 dB of noise reduction would be required for first-floor facades.

Standard residential construction (wood siding, STC-26 windows, door weather-stripping, exterior wall insulation, composition plywood roof), results in an exterior to interior noise reduction of 25 dB with windows closed and approximately 15 dB with windows open. Therefore, standard construction would be acceptable for this project at all residences of this development. Nonetheless, mechanical ventilation should be provided to allow occupants to close doors and windows as desired for acoustical isolation.

Evaluation of Serrano Village J5 Commercial Center Noise Generation

Noise Sources Evaluated

The major noise-producing components of the Serrano Village J5 Commercial Center identified as potentially significant consist of parking lot activity, rooftop mechanical equipment, and loading dock activities. Each of these noise sources are evaluated separately below.

Parking Lot Noise

As a means of determining potential noise exposure due to project parking lot activities, Bollard Acoustical Consultants, Inc. utilized noise level data collected for previous parking lot noise studies. A typical sound exposure level (SEL) due to automobile arrivals/departures, including car doors slamming and people conversing, is approximately 70 dB at a distance of 50 feet. The approximate distance between the center of the nearest proposed parking lot area, located just north of Building F, and the closest residential areas to the northeast, Lots 7 and 8, is 150 feet.

Based on the capacity of the nearest parking lot, it was assumed that 42 cars could enter or leave the parking lot within a worst-case hour. Parking lot noise exposure was determined using the following equation.

$$\text{Peak Hour } L_{eq} = 70 + 10 \cdot \log(N) - 35.6$$

Where 70 is the SEL for a single automobile parking operation, N is the number of parking lot operations in a peak hour, and 35.6 is 10 times the logarithm of the number of seconds in an hour.

Using the equation and operations data described above, the proposed parking lot could be expected to produce a noise exposure of approximately 41 dB Peak Hour L_{eq} at the closest residential property lines. Therefore, noise exposure is expected to comply with the County's noise exposure standards and is not expected to be a significant impact on the closest residents and no mitigation measures are required.

Mechanical Equipment Noise

Heating, ventilating, and air conditioning (HVAC) requirements for this store will likely be met using rooftop mounted systems located atop the building. The units would be shielded from view of neighboring residential uses by intervening building parapets.

BAC reference file data for packaged HVAC systems indicate that a 12.5-ton packaged unit can be expected to generate an A-weighted sound power level of 85 dB. When projected to the nearest residential property lines 175 feet from the equipment location, the resulting levels compute to approximately 35 dB L_{eq} , including 5 dB of shielding provided by the building parapets.

Because the predicted HVAC equipment noise level of 35 dB L_{eq} is below measured existing ambient noise levels in the project vicinity and below County noise standards, no noise impacts are identified for this aspect of the project, and no additional consideration of noise mitigation measures would be warranted.

Truck Delivery and Unloading Noise

According to the commercial site plans shown on Figure 3, the commercial area would have only one truck loading dock, as the smaller stores would load through the front entrance with smaller trucks. The loading dock associated with the Market is approximately 750 feet from the residential project site and would be completely shielded from view of those proposed residences by the intervening market building. Given this distance and shielding, truck unloading operations at the commercial market are predicted to be inaudible at the proposed residential locations, and well below El Dorado County noise standards. As a result, no noise impacts are identified for this aspect of the project, and no additional consideration of noise mitigation measures is warranted.

Conclusions

The residential portion of Serrano Village J5 & J6 project site will be exposed to future Bass Lake Road traffic noise levels in excess of El Dorado County 60 dB L_{dn} exterior noise level standard for new residential developments. The following specific noise mitigation measures are recommended to achieve compliance with the County's noise standards:

- A 6-foot tall barrier would be required to reduce future traffic noise levels to approximately 60 dB L_{dn} in the backyards located adjacent to Bass Lake Road. Figure 2 shows the recommended locations of the noise barrier.
- Suitable materials for the traffic noise barriers include masonry and precast concrete panels. Other materials may be acceptable but should be reviewed by an acoustical consultant prior to use.
- Mechanical ventilation (air conditioning) should be provided for all residences in this development to allow the occupants to close doors and windows as desired to achieve compliance with the applicable interior noise level criteria.

These conclusions are based on the Bass Lake Road traffic assumptions cited in Appendix E and on noise reduction data for standard residential dwellings. Deviations from the Appendix E data, or the project site plan shown in Figure 2, could cause future traffic noise levels to differ from those predicted in this analysis. In addition, Bollard Acoustical Consultants, Inc. is not responsible for degradation in acoustic performance of the residential construction due to poor construction practices, failure to comply with applicable building code requirements, or for failure to adhere to the minimum building practices cited in this report.

Appendix A Acoustical Terminology

Acoustics	The science of sound.
Ambient Noise	The distinctive acoustical characteristics of a given space consisting of all noise sources audible at that location. In many cases, the term ambient is used to describe an existing or pre-project condition such as the setting in an environmental noise study.
Attenuation	The reduction of an acoustic signal.
A-Weighting	A frequency-response adjustment of a sound level meter that conditions the output signal to approximate human response.
Decibel or dB	Fundamental unit of sound, A Bell is defined as the logarithm of the ratio of the sound pressure squared over the reference pressure squared. A Decibel is one-tenth of a Bell.
CNEL	Community Noise Equivalent Level. Defined as the 24-hour average noise level with noise occurring during evening hours (7 - 10 p.m.) weighted by a factor of three and nighttime hours weighted by a factor of 10 prior to averaging.
Frequency	The measure of the rapidity of alterations of a periodic signal, expressed in cycles per second or hertz.
L_{dn}	Day/Night Average Sound Level. Similar to CNEL but with no evening weighting.
Leq	Equivalent or energy-averaged sound level.
L_{max}	The highest root-mean-square (RMS) sound level measured over a given period of time.
Loudness	A subjective term for the sensation of the magnitude of sound.
Masking	The amount (or the process) by which the threshold of audibility is for one sound is raised by the presence of another (masking) sound.
Noise	Unwanted sound.
Peak Noise	The level corresponding to the highest (not RMS) sound pressure measured over a given period of time. This term is often confused with the Maximum level, which is the highest RMS level.
RT₆₀	The time it takes reverberant sound to decay by 60 dB once the source has been removed.
Sabin	The unit of sound absorption. One square foot of material absorbing 100% of incident sound has an absorption of 1 sabin.
SEL	A rating, in decibels, of a discrete event, such as an aircraft flyover or train passby, that compresses the total sound energy of the event into a 1-s time period.
Threshold of Hearing	The lowest sound that can be perceived by the human auditory system, generally considered to be 0 dB for persons with perfect hearing.
Threshold of Pain	Approximately 120 dB above the threshold of hearing.

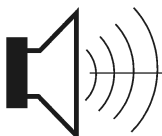

BOLLARD

Acoustical Consultants

**Appendix B-1
Serrano Village J5 & J6
24hr Continuous Noise Monitoring at Site A
August 7-8, 2013**

Hour	Leq	Lmax	L50	L90
15:00	57	69	55	43
16:00	58	70	57	45
17:00	60	75	58	51
18:00	60	70	58	48
19:00	59	76	57	46
20:00	58	69	57	46
21:00	57	72	55	40
22:00	56	73	48	34
23:00	53	68	41	31
0:00	52	67	35	29
1:00	49	67	31	27
2:00	45	65	28	25
3:00	49	66	30	26
4:00	53	69	34	28
5:00	59	75	54	37
6:00	62	75	60	47
7:00	62	75	61	52
8:00	61	73	58	48
9:00	58	76	53	43
10:00	57	81	51	41
11:00	57	76	53	42
12:00	56	69	51	40
13:00	57	78	52	42
14:00	56	72	51	41

Statistical Summary						
	Daytime (7 a.m. - 10 p.m.)			Nighttime (10 p.m. - 7 a.m.)		
	High	Low	Average	High	Low	Average
Leq (Average)	62.3	55.5	58.6	61.7	45.4	55.8
Lmax (Maximum)	81.5	68.7	73.4	75.1	65.2	69.4
L50 (Median)	61.2	50.9	55.2	60.4	27.8	40.2
L90 (Background)	51.9	40.0	44.6	47.1	25.3	31.6

Computed Ldn, dB	62.7
% Daytime Energy	76%
% Nighttime Energy	24%

**Appendix B-2
Serrano Village J5 & J6
24hr Continuous Noise Monitoring at Site A
August 8-9, 2013**

Hour	Leq	Lmax	L50	L90
15:00	56	71	53	43
16:00	57	77	55	45
17:00	58	70	56	47
18:00	58	69	56	45
19:00	58	72	56	45
20:00	57	68	56	44
21:00	58	69	56	47
22:00	54	68	48	33
23:00	53	67	42	32
0:00	51	68	39	31
1:00	51	70	34	27
2:00	47	64	28	25
3:00	45	66	29	26
4:00	53	73	35	30
5:00	58	73	51	39
6:00	62	73	61	47
7:00	63	74	62	53
8:00	61	75	59	49
9:00	58	71	54	43
10:00	57	72	52	41
11:00	57	76	51	39
12:00	57	72	52	38
13:00	57	76	52	40
14:00	57	72	54	43

Statistical Summary						
	Daytime (7 a.m. - 10 p.m.)			Nighttime (10 p.m. - 7 a.m.)		
	High	Low	Average	High	Low	Average
Leq (Average)	63.0	56.2	58.3	62.2	45.1	55.7
Lmax (Maximum)	76.5	68.3	72.3	73.4	64.1	69.0
L50 (Median)	62.1	51.1	55.0	60.5	28.4	40.7
L90 (Background)	52.6	38.5	44.1	46.8	25.2	32.0

Computed Ldn, dB	62.6
% Daytime Energy	75%
% Nighttime Energy	25%

Appendix C-1
Serrano Village J5 & J6
24hr Continuous Noise Monitoring at Site A
August 7-8, 2013

Sound Level, dBA

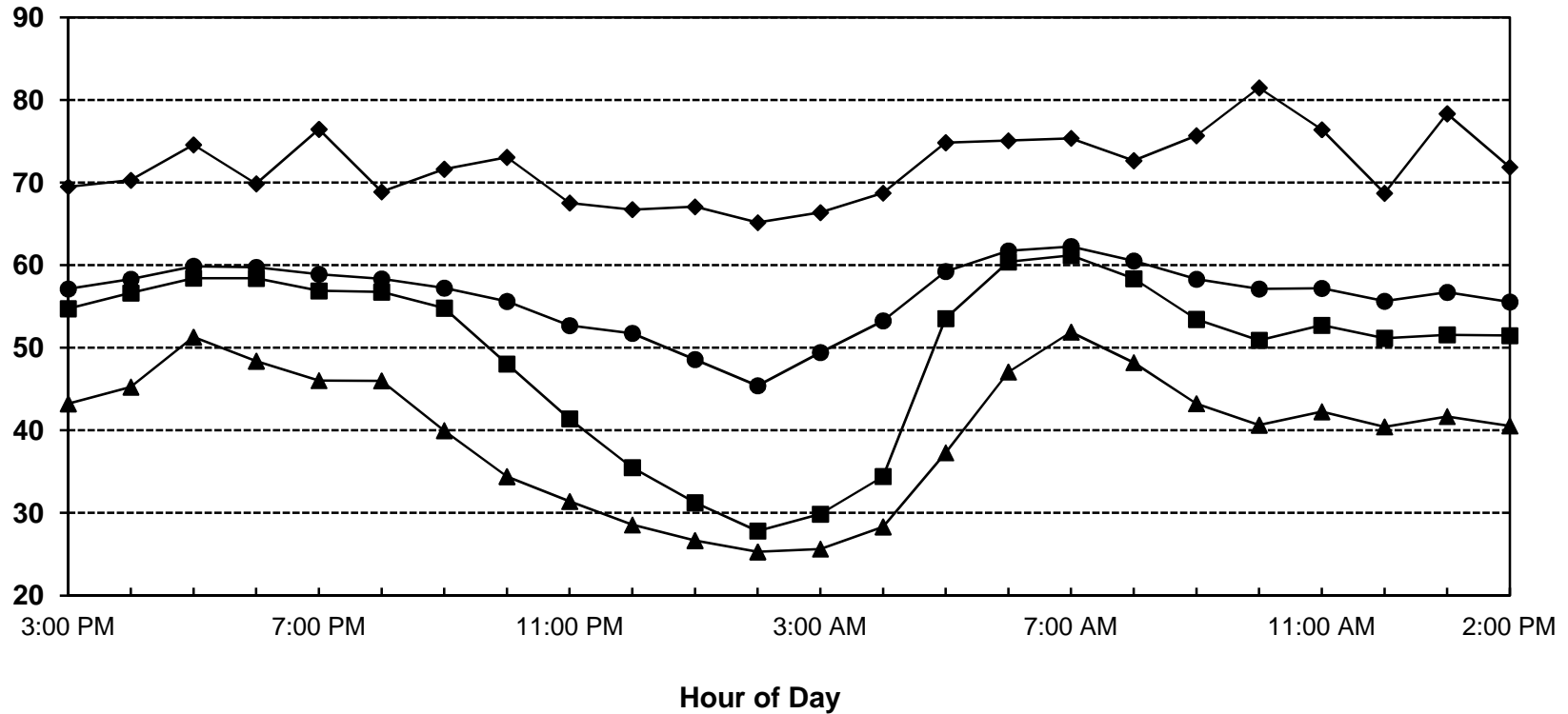

● Average (Leq)
 ◆ Maximum (Lmax)
 ■ L50
 ▲ L90

Ldn: 63 dB



Appendix C-2
Serrano Village J5 & J6
24hr Continuous Noise Monitoring at Site A
August 8-9, 2013

Sound Level, dBA

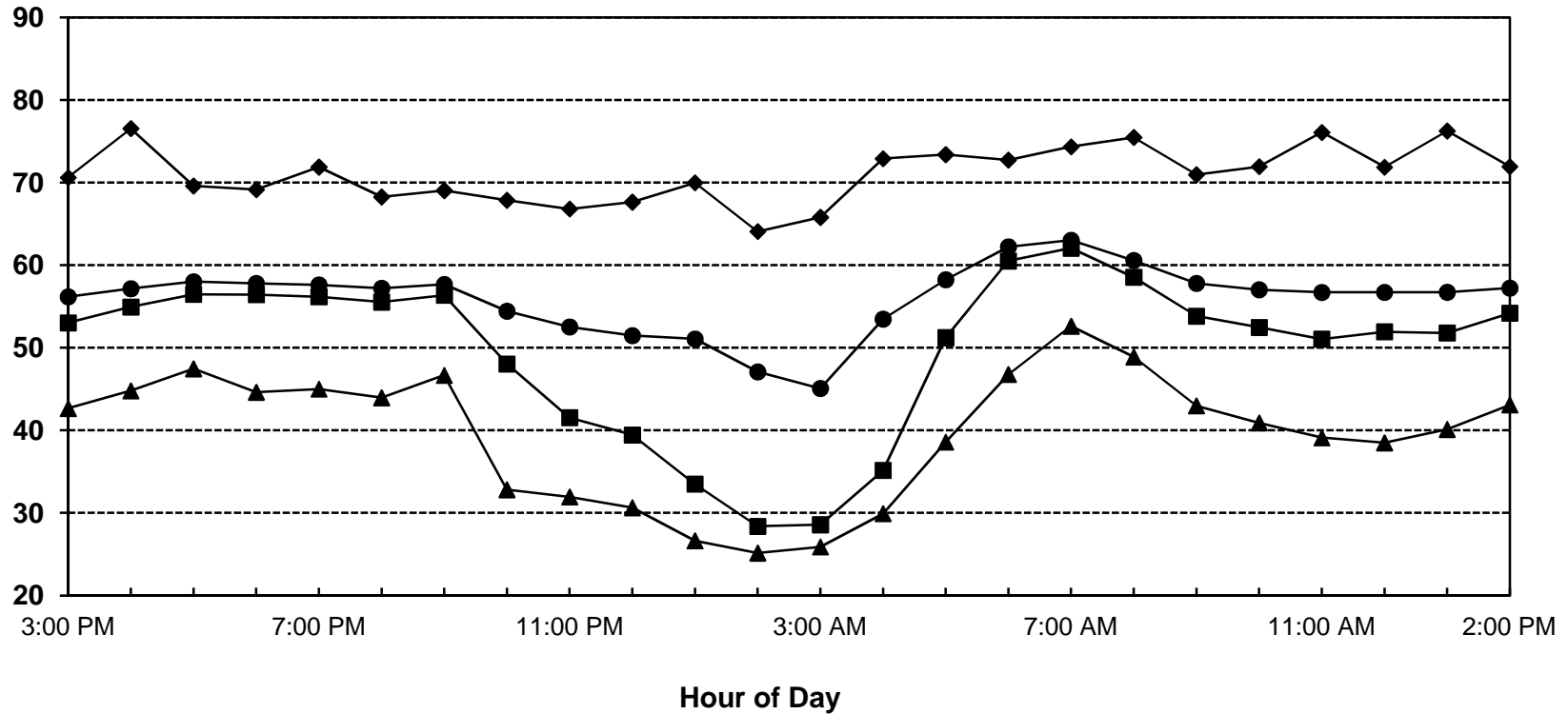

● Average (Leq)
 ◆ Maximum (Lmax)
 ■ L50
 ▲ L90

Ldn: 63 dB



Appendix D-1
FHWA Traffic Noise Prediction Model (FHWA-RD-77-108)
Calibration Worksheet

Project Information: Job Number: 2013-070
Project Name: Serrano Villages J5 & J6
Roadway Tested: Bass Lake Road
Test Location: Site 1
Test Date: August 7, 2013

Weather Conditions: Temperature (Fahrenheit): 85
Relative Humidity: Moderate
Wind Speed and Direction: Calm
Cloud Cover: Clear

Sound Level Meter: Sound Level Meter: LDL Model 820
Calibrator: LDL Model CAL200
Meter Calibrated: Immediately before
Meter Settings: A-weighted, slow response

Microphone: Microphone Location: On project site
Distance to Centerline (feet): 80
Microphone Height: 5 feet above ground
Intervening Ground (Hard or Soft): **Soft**
Elevation Relative to Road (feet): 5

Roadway Condition: Pavement Type Asphalt
Pavement Condition: Good
Number of Lanes: 2
Posted Maximum Speed (mph): 50

Test Parameters: Test Time: 2:55 PM
Test Duration (minutes): 15
Observed Number Automobiles: 138
Observed Number Medium Trucks: 2
Observed Number Heavy Trucks: 0
Observed Average Speed (mph): 40

Model Calibration: Measured Average Level (L_{eq}): 59.1
Level Predicted by FHWA Model: 59.6
Difference: 0.5 dB

Conclusions:



Appendix D-2
FHWA Traffic Noise Prediction Model (FHWA-RD-77-108)
Calibration Worksheet

Project Information: Job Number: 2013-070
Project Name: Serrano Villages J5 & J6
Roadway Tested: Bass Lake Road
Test Location: Site 2
Test Date: August 7, 2013

Weather Conditions: Temperature (Fahrenheit): 85
Relative Humidity: Moderate
Wind Speed and Direction: Calm
Cloud Cover: Clear

Sound Level Meter: Sound Level Meter: LDL Model 820
Calibrator: LDL Model CAL200
Meter Calibrated: Immediately before
Meter Settings: A-weighted, slow response

Microphone: Microphone Location: On project site
Distance to Centerline (feet): 50
Microphone Height: 5 feet above ground
Intervening Ground (Hard or Soft): **Soft**
Elevation Relative to Road (feet): 5

Roadway Condition: Pavement Type Asphalt
Pavement Condition: Good
Number of Lanes: 2
Posted Maximum Speed (mph): 50

Test Parameters: Test Time: 2:30 PM
Test Duration (minutes): 15
Observed Number Automobiles: 74
Observed Number Medium Trucks: 2
Observed Number Heavy Trucks: 0
Observed Average Speed (mph): 50

Model Calibration: Measured Average Level (L_{eq}): 62.9
Level Predicted by FHWA Model: 63.0
Difference: 0.1 dB

Conclusions:

**Appendix E
FHWA Traffic Noise Prediction Model (FHWA-RD-77-108)
Noise Prediction Worksheet**

Project Information:

Job Number: 2013-070
Project Name: Serrano Villages J5 & J6
Roadway Name: Bass Lake Road

Traffic Data:

Year: 2035
Average Daily Traffic Volume: 7,900
Percent Daytime Traffic: 76
Percent Nighttime Traffic: 24
Percent Medium Trucks (2 axle): 2
Percent Heavy Trucks (3+ axle): 1
Assumed Vehicle Speed (mph): 50
Intervening Ground Type (hard/soft): **Soft**

Traffic Noise Levels:

Location:	Description	Distance	Offset (dB)	-----L _{dn} , dB-----			Total
				Autos	Medium Trucks	Heavy Trucks	
1	Lot 15	95	0	63	54	55	64
2	Lot 23	90	0	64	55	56	65
3	Lot 28	90	0	64	55	56	65
4	Lot 77	140	0	61	52	53	62
5	Lot 96	95	0	63	54	55	64
6	Lot 101	245	0	57	48	49	58

Traffic Noise Contours (No Calibration Offset):

L _{dn} Contour, dB	Distance from Centerline, (ft)
75	19
70	41
65	87
60	188



Appendix F-1
FHWA Traffic Noise Prediction Model (FHWA-RD-77-108)
Noise Barrier Effectiveness Prediction Worksheet

Project Information: Job Number: 2013-070
 Project Name: Serrano Villages J5 & J6
 Roadway Name: Bass Lake Road
 Location(s): Lot 15

Noise Level Data: Year: 2035
 Auto L_{dn} , dB: 63
 Medium Truck L_{dn} , dB: 54
 Heavy Truck L_{dn} , dB: 55

Site Geometry: Receiver Description: Lot 15
 Centerline to Barrier Distance (C_1): 80
 Barrier to Receiver Distance (C_2): 15
 Automobile Elevation: 1216
 Medium Truck Elevation: 1218
 Heavy Truck Elevation: 1224
 Pad/Ground Elevation at Receiver: 1234
 Receiver Elevation¹: 1239
 Base of Barrier Elevation: 1234
 Starting Barrier Height 5

Barrier Effectiveness:

Top of Barrier Elevation (ft)	Barrier Height ² (ft)	----- L_{dn} , dB -----				Barrier Breaks Line of Sight to...		
		Autos	Medium Trucks	Heavy Trucks	Total	Autos?	Medium Trucks?	Heavy Trucks?
1239	5	55	46	49	56	Yes	Yes	Yes
1240	6	54	45	47	55	Yes	Yes	Yes
1241	7	53	44	46	54	Yes	Yes	Yes
1242	8	52	43	45	53	Yes	Yes	Yes
1243	9	51	42	44	52	Yes	Yes	Yes
1244	10	50	41	43	51	Yes	Yes	Yes
1245	11	49	40	42	51	Yes	Yes	Yes
1246	12	49	40	42	50	Yes	Yes	Yes
1247	13	49	40	41	50	Yes	Yes	Yes

Notes: 1. Standard receiver elevation is five feet above grade/pad elevations at the receiver location(s)



Appendix F-2
FHWA Traffic Noise Prediction Model (FHWA-RD-77-108)
Noise Barrier Effectiveness Prediction Worksheet

Project Information: Job Number: 2013-070
 Project Name: Serrano Villages J5 & J6
 Roadway Name: Bass Lake Road
 Location(s): Lot 23

Noise Level Data: Year: 2035
 Auto L_{dn} , dB: 64
 Medium Truck L_{dn} , dB: 55
 Heavy Truck L_{dn} , dB: 56

Site Geometry: Receiver Description: Lot 23
 Centerline to Barrier Distance (C_1): 75
 Barrier to Receiver Distance (C_2): 15
 Automobile Elevation: 1237
 Medium Truck Elevation: 1239
 Heavy Truck Elevation: 1245
 Pad/Ground Elevation at Receiver: 1251
 Receiver Elevation¹: 1256
 Base of Barrier Elevation: 1251
 Starting Barrier Height 5

Barrier Effectiveness:

Top of Barrier Elevation (ft)	Barrier Height ² (ft)	----- L_{dn} , dB -----				Barrier Breaks Line of Sight to...		
		Autos	Medium Trucks	Heavy Trucks	Total	Autos?	Medium Trucks?	Heavy Trucks?
1256	5	56	47	50	57	Yes	Yes	Yes
1257	6	55	46	48	56	Yes	Yes	Yes
1258	7	53	45	47	55	Yes	Yes	Yes
1259	8	53	44	46	54	Yes	Yes	Yes
1260	9	52	43	45	53	Yes	Yes	Yes
1261	10	51	42	44	52	Yes	Yes	Yes
1262	11	50	41	43	51	Yes	Yes	Yes
1263	12	49	40	42	51	Yes	Yes	Yes
1264	13	49	40	42	50	Yes	Yes	Yes

Notes: 1. Standard receiver elevation is five feet above grade/pad elevations at the receiver location(s)



Appendix F-3
FHWA Traffic Noise Prediction Model (FHWA-RD-77-108)
Noise Barrier Effectiveness Prediction Worksheet

Project Information: Job Number: 2013-070
 Project Name: Serrano Villages J5 & J6
 Roadway Name: Bass Lake Road
 Location(s): Lot 28

Noise Level Data: Year: 2035
 Auto L_{dn}, dB: 64
 Medium Truck L_{dn}, dB: 55
 Heavy Truck L_{dn}, dB: 56

Site Geometry: Receiver Description: Lot 28
 Centerline to Barrier Distance (C₁): 75
 Barrier to Receiver Distance (C₂): 15
 Automobile Elevation: 1250
 Medium Truck Elevation: 1252
 Heavy Truck Elevation: 1258
 Pad/Ground Elevation at Receiver: 1268
 Receiver Elevation¹: 1273
 Base of Barrier Elevation: 1268
 Starting Barrier Height 5

Barrier Effectiveness:

Top of Barrier Elevation (ft)	Barrier Height ² (ft)	----- L _{dn} , dB -----				Barrier Breaks Line of Sight to...		
		Autos	Medium Trucks	Heavy Trucks	Total	Autos?	Medium Trucks?	Heavy Trucks?
1273	5	55	46	49	56	Yes	Yes	Yes
1274	6	54	45	47	55	Yes	Yes	Yes
1275	7	53	44	46	54	Yes	Yes	Yes
1276	8	52	43	45	53	Yes	Yes	Yes
1277	9	51	42	44	52	Yes	Yes	Yes
1278	10	50	41	43	51	Yes	Yes	Yes
1279	11	50	41	42	51	Yes	Yes	Yes
1280	12	49	40	42	50	Yes	Yes	Yes
1281	13	48	40	41	50	Yes	Yes	Yes

Notes: 1. Standard receiver elevation is five feet above grade/pad elevations at the receiver location(s)



Appendix F-4
FHWA Traffic Noise Prediction Model (FHWA-RD-77-108)
Noise Barrier Effectiveness Prediction Worksheet

Project Information: Job Number: 2013-070
 Project Name: Serrano Villages J5 & J6
 Roadway Name: Bass Lake Road
 Location(s): Lot 77

Noise Level Data: Year: 2035
 Auto L_{dn}, dB: 61
 Medium Truck L_{dn}, dB: 52
 Heavy Truck L_{dn}, dB: 53

Site Geometry: Receiver Description: Lot 77
 Centerline to Barrier Distance (C₁): 125
 Barrier to Receiver Distance (C₂): 15
 Automobile Elevation: 1251
 Medium Truck Elevation: 1253
 Heavy Truck Elevation: 1259
 Pad/Ground Elevation at Receiver: 1285
 Receiver Elevation¹: 1290
 Base of Barrier Elevation: 1285
 Starting Barrier Height 5

Barrier Effectiveness:

Top of Barrier Elevation (ft)	Barrier Height ² (ft)	----- L _{dn} , dB -----				Barrier Breaks Line of Sight to...		
		Autos	Medium Trucks	Heavy Trucks	Total	Autos?	Medium Trucks?	Heavy Trucks?
1290	5	52	43	45	53	Yes	Yes	Yes
1291	6	51	42	44	52	Yes	Yes	Yes
1292	7	50	41	43	51	Yes	Yes	Yes
1293	8	49	40	42	50	Yes	Yes	Yes
1294	9	48	39	41	49	Yes	Yes	Yes
1295	10	47	38	40	49	Yes	Yes	Yes
1296	11	47	38	39	48	Yes	Yes	Yes
1297	12	46	37	39	47	Yes	Yes	Yes
1298	13	46	37	38	47	Yes	Yes	Yes

Notes: 1. Standard receiver elevation is five feet above grade/pad elevations at the receiver location(s)



**Appendix F-5
FHWA Traffic Noise Prediction Model (FHWA-RD-77-108)
Noise Barrier Effectiveness Prediction Worksheet**

Project Information: Job Number: 2013-070
Project Name: Serrano Villages J5 & J6
Roadway Name: Bass Lake Road
Location(s): Lot 96

Noise Level Data: Year: 2035
Auto L_{dn}, dB: 63
Medium Truck L_{dn}, dB: 54
Heavy Truck L_{dn}, dB: 55

Site Geometry: Receiver Description: Lot 96
Centerline to Barrier Distance (C₁): 80
Barrier to Receiver Distance (C₂): 15
Automobile Elevation: 1240
Medium Truck Elevation: 1242
Heavy Truck Elevation: 1248
Pad/Ground Elevation at Receiver: 1243
Receiver Elevation¹: 1248
Base of Barrier Elevation: 1243
Starting Barrier Height 5

Barrier Effectiveness:

Top of Barrier Elevation (ft)	Barrier Height ² (ft)	----- L _{dn} , dB -----				Barrier Breaks Line of Sight to...		
		Autos	Medium Trucks	Heavy Trucks	Total	Autos?	Medium Trucks?	Heavy Trucks?
1248	5	58	49	50	59	Yes	Yes	No
1249	6	57	48	50	58	Yes	Yes	Yes
1250	7	55	47	49	57	Yes	Yes	Yes
1251	8	54	45	48	56	Yes	Yes	Yes
1252	9	53	44	46	54	Yes	Yes	Yes
1253	10	52	43	45	54	Yes	Yes	Yes
1254	11	51	42	44	53	Yes	Yes	Yes
1255	12	50	41	43	52	Yes	Yes	Yes
1256	13	50	41	43	51	Yes	Yes	Yes

Notes: 1. Standard receiver elevation is five feet above grade/pad elevations at the receiver location(s)



El Dorado Hills Specific Plan

Actual Scenario

Table 1: Summary of Residential Use by Development Neighborhood
January 2017 (includes pending applications for Serrano Village A14, D1 Lots C & D, and J5/J6)

	Specific Plan			Actual ⁽¹⁾			(Reduction) / Increase from Specific Plan		
	(a) Dwelling Units	(b) Net Acres ⁽²⁾	(c) Net D.U./ac	(d) Dwelling Units	(e) Net Acres ⁽²⁾	(f) Net D.U./ac	(d) - (a) Dwelling Units	(e) - (b) Net Acres ⁽²⁾	(f) - (c) Net D.U./ac
NORTH UPLANDS									
Village H	362	160		267	213		(95)	53	
Village I	699	134		218	147		(481)	13	
Village J	342	117		483	150		141	33	
Village K	458	236		671	338		213	102	
Village L	56	25		110	68		54	43	
Village M	37	148		168	162		131	14	
	<u>1,954</u>	<u>820</u>	<u>2.38</u>	<u>1,917</u>	<u>1,077</u>	<u>1.78</u>	<u>(37)</u>	<u>257</u>	<u>(0.60)</u>
SOUTH UPLANDS									
Village C	482	252		427	162		(55)	(90)	
Village E	282	109		696	190		414	81	
Village F	553	107		257	74		(296)	(33)	
Village G	905	192		199	66		(706)	(126)	
	<u>2,222</u>	<u>660</u>	<u>3.37</u>	<u>1,579</u>	<u>493</u>	<u>3.20</u>	<u>(643)</u>	<u>(167)</u>	<u>(0.16)</u>
VALLEY									
Village A	606	151		376	117		(230)	(34)	
Village B	212	53		196	50		(16)	(3)	
Village D	1,051	250		787	266		(264)	16	
Village P (by others)	90	53		0	0		(90)	(53)	
Village Q (by others)	27	27		0	0		(27)	(27)	
Village V (by others)	0	7		0	0		0	(7)	
	<u>1,986</u>	<u>541</u>	<u>3.67</u>	<u>1,359</u>	<u>434</u>	<u>3.13</u>	<u>(627)</u>	<u>(107)</u>	<u>(0.54)</u>
	<u>6,162</u>	<u>2,021</u>	<u>3.05</u> *	<u>4,855</u>	<u>2,003</u>	<u>2.42</u> **	<u>(1,307)</u>	<u>(18)</u>	<u>(0.63)</u>
	* NET DENSITY (Specific Plan Area)			** NET DENSITY (Actual - Serrano Portion)					
MISCELLANEOUS									
Village T (by others)		126		126	<i>(assumes no change)</i>			0	
Village U (by others)		130		130	<i>(assumes no change)</i>			0	
		<u>256</u>		<u>256</u>					
MISCELLANEOUS									
Village J (Commercial)		45		12 ^[3]				(33)	
Village Green		27		27				0	
Village R (by others)		157		157	<i>(assumes no change)</i>			0	
Village W (by others)		13		13	<i>(assumes no change)</i>			0	
Circulation		139		139	<i>(assumes no change)</i>			0	
Schools		60		48 ^[4]				(12)	
Golf Course		370		189 ^[5]				(181)	
Open Space		808		989 ^[6]				181	
		<u>3,896</u>	<u>1.58</u>	<u>3,833</u>	<u>1.27</u>				
		Gross Density		Gross Density					

[1] Serrano portion only, as developed, mapped, and planned.

[2] Defined by the Specific Plan as the number of acres excluding open space, major circulation routes, and school sites.

[3] Village J5 Phase 1

[4] Includes Oak Meadow School, Silva Valley School, and Rolling Hills School. Rescue Union is pursuing a school site outside the Serrano boundary.

[5] In April 2000, the Planning Commission voted to approve abandonment of the 2nd golf course described in the Specific Plan in favor of open space accessible to the public.

[6] Minimum required open space acreage as a result abandonment of 2nd golf course. 1,178 total Golf Course and Open Space acres, less 189 ac for Golf Course, equals 989 ac.



El Dorado Hills Area Planning Advisory Committee

1021 Harvard Way
El Dorado Hills, CA 95762

2017 Board Chair

Tim White

Vice Chair

John Raslear

Secretary

Kathy Prevost

January 17, 2017

El Dorado County Community Development Agency
Development Services Department, Planning Division

Attn: Mel Pabalinas
2850 Fairlane Court
Placerville, CA. 95667

Subject: APAC Recommendations -Serrano Village J5J6

Dear Board of Supervisors, Planning Commission and County Staff,

The APAC Board will present these comments and recommendations about J5J6 to our full membership at our February meeting for approval.

At our APAC November 2016 Meeting, Kirk Bone and Andrea Howard representatives of Parker Associates presented a fact sheet ((Village J5J6 Development Standards (148 lots) September 2016)) comparing County Ordinance Requirements and Serrano modification for J5/J6. It was stated that Serrano Associates had received previous approval for these exceptions to the required county zoning ordinance regarding setbacks on all their projects. We will call this exception to the county standards "Parker Exceptions". These "Parker Exceptions" possibly may have made sense when Serrano was being continuously built out between EDH Boulevard and Bass Lake Road, but, should these "Parker Exceptions" be applied for new Parker/Serrano developments located north of Bass Lake Road?

Many new residential and some retail projects will be built north of Bass Lake Road in the next 20 years. This area is mostly undeveloped and should J5J6 be allowed to apply previously approved "Parker Exceptions" as the standard for this new area. If that is allowed then the "Parker Exceptions" will no longer be an "exception" but will by default become the new "standard".

We have attached the fact sheet presented by Kirk Bone. Please note the highlighted differences:

- Rear yard setback- 15 feet standard, Parker Exception 10 feet - a 33% Reduction
- Side yard setback – county standard 5 feet , Parker Exception 3 feet
- Setback for any structure over 30 inches high- 15 feet standard, Parker Exception 5 feet- a 66% Reduction
- Maximum building coverage - standard 35%, Parker Exception 65%- almost a 100% Increase!!!

Other items that need to be addressed:

Bike Lanes

Maps do not show:

Minimum class 2 bike paths on Bass Lake Road

Minimum class 2 bike paths on Sienna Ridge Drive.

Park land & Facilities

Lack of park facilities exacerbated by non standard back yards

Only one pedestrian path into passive park

Who will maintain passive park?

APAC appreciates having the opportunity to provide comments. If you have any questions please contact Tim White , 2017 APAC Chair at tjwhitejd@gmail.com or John Raslear, Vice Chair at jjrazzpub@sbcglobal.net.

Sincerely,

Tim White Board Chair

John Raslear Vice Chair

2017 APAC Committee Chair

Cc: EDCO Planning Commission

EDCO BOS

APAC read file

