



# at&t

SITE NUMBER: CVL03629  
 SITE NAME: ZEE ESTATES

GATE LANE 1,000' SOUTH EAST OF  
 THE INTERSECTION OF GATE LANE  
 AND SALMON FALLS ROAD  
 PILOT HILL, CA 95664  
 APN: 104-370-24-100

PROPRIETARY INFORMATION  
 THE INFORMATION CONTAINED IN THIS  
 SET OF DRAWINGS IS PROPRIETARY  
 BY NATURE. ANY USE OR  
 DISCLOSURE OTHER THAN THAT WHICH  
 RELATES TO PEEK SITE-COM IS  
 STRICTLY PROHIBITED

CLIENT:

5001 EXECUTIVE PKWY  
 SAN RAMON, CA 94583

PROJECT INFORMATION	PROJECT TEAM	SHEET INDEX
<p><b>APPLICANT:</b>            AT&amp;T MOBILITY            5001 EXECUTIVE PKWY            SAN RAMON, CA 94583</p> <p><b>CONSTRUCTION MANAGER:</b>            PETE MANAS            EPIC WIRELESS            8700 AUBURN FOLSOM ROAD, SUITE 400            GRANITE BAY, CA 95746            (530) 383-5957</p> <p><b>SITE SURVEY:</b>            GEIL ENGINEERING            1226 HIGH STREET            AUBURN, CA 95603            (530) 885-0426</p> <p><b>RF ENGINEER:</b>            ASAD SCHAHBAZ            MS455V@ATT.COM</p> <p><b>RFDS VERSION/DATE:</b>            1.00.01 / 05-01-17            1.00.02 / 5-22-17</p>	<p><b>ENGINEERING FIRM:</b>            PEEK SITE-COM            12852 EARHART AVE SUITE 101            AUBURN, CA 95602            (530) 885-6160</p> <p><b>SITE ACQUISITION &amp; PLANNING:</b>            JARED KEARSLEY            EPIC WIRELESS            8700 AUBURN FOLSOM ROAD, SUITE 400            GRANITE BAY, CA 95746            (916) 755-1326</p> <p><b>CIVIL VENDOR:</b>            VINCULUMS CONSTRUCTION MANAGER            KEN ABEL            KABEL@VINCULUMS.COM            (916) 844-4602</p>	<p><b>SITE NAME:</b> ZEE ESTATES  <b>SITE NUMBER:</b> CVL03629  <b>FA LOCATION#:</b> 13787593</p> <p><b>SITE ADDRESS:</b>            GATE LANE 1,000' SOUTH EAST OF THE INTERSECTION OF GATE            LANE AND SALMON FALLS ROAD            PILOT HILL, CA 95664</p> <p><b>ASSESSORS PARCEL NUMBER:</b> 104-370-24-100  <b>LATITUDE:</b> 38.483647°  <b>LONGITUDE:</b> -121.011305°  <b>ELEVATION:</b> 1,563' AMSL</p> <p><b>ZONING:</b> LA-10  <b>JURISDICTION:</b> EL DORADO COUNTY  <b>COUNTY:</b> EL DORADO</p> <p><b>PROPERTY OWNER:</b> WOLFE FAMILY TRUST  <b>OWNER ADDRESS:</b> 9289 SHADOW BROOK PLACE            GRANITE BAY, CA 95746</p>
		<p>T-1 TITLE SHEET            GN-1 GENERAL NOTES            GN-2 SITE SIGNAGE            C-1 SITE SURVEY            C-2 SITE SURVEY            C-3 EROSION CONTROL PLAN &amp; DETAILS            C-4 GRADING NOTES &amp; DETAILS            C-5 PRELIMINARY GROUNDING PLAN            A-1 OVERALL SITE PLAN            A-2 EQUIPMENT PLAN            A-3 ANTENNA PLAN &amp; DETAILS            A-4 ELEVATIONS            A-4.1 ELEVATIONS</p>

PROJECT INFORMATION:

**ZEE ESTATES**  
 GATE LANE 1,000' SOUTH EAST OF THE INTERSECTION OF GATE  
 LANE AND SALMON FALLS ROAD  
 PILOT HILL, CA 95664

REV: = DATE: DESCRIPTION: BY:

1	6-29-17	90% ZONING DOC'S	RB
1	8-3-17	90% ZONING DOC'S	ALP
2	8-9-17	100% ZONING DOC'S	ALP

CODE COMPLIANCE	VICINITY MAP	DIRECTIONS FROM AT&T	PROJECT DESCRIPTION
<p>ALL WORK AND MATERIALS SHALL BE PERFORMED AND INSTALLED IN ACCORDANCE WITH THE CURRENT EDITIONS OF THE FOLLOWING CODES AS ADOPTED BY THE LOCAL GOVERNING AUTHORITIES. NOTHING IN THESE PLANS IS TO BE CONSTRUED TO PERMIT WORK NOT CONFORMING TO THESE CODES.</p> <ol style="list-style-type: none"> <li>2016 CALIFORNIA BUILDING CODE</li> <li>2016 CALIFORNIA FIRE CODE</li> <li>2016 CALIFORNIA ELECTRICAL CODE</li> <li>2016 CALIFORNIA PLUMBING CODE</li> <li>2016 CALIFORNIA MECHANICAL CODE</li> <li>2016 CALIFORNIA HEALTH AND SAFETY CODE</li> </ol>	<p>SITE LOCATION</p>	<p>DIRECTIONS FROM AT&amp;T'S OFFICE AT 5001 EXECUTIVE PARKWAY, SAN RAMON, CA 94583</p> <ol style="list-style-type: none"> <li>HEAD NORTHEAST ON BISHOP DR TOWARD SUNSET DR</li> <li>TURN RIGHT ONTO SUNSET DR</li> <li>USE THE RIGHT 2 LANES TO TURN RIGHT ONTO BOLLINGER CANYON RD</li> <li>USE THE RIGHT 2 LANES TO MERGE ONTO I-680 N VIA THE RAMP TO SACRAMENTO</li> <li>MERGE ONTO I-680 N</li> <li>KEEP LEFT TO STAY ON I-680 N</li> <li>KEEP LEFT AT THE FORK TO STAY ON I-680 N</li> <li>KEEP LEFT AT THE FORK TO CONTINUE ON I-680</li> <li>USE ANY LANE TO TAKE EXIT 71A TOWARD I-80 E/SACRAMENTO</li> <li>MERGE ONTO I-80 E</li> <li>KEEP LEFT AT THE FORK TO STAY ON I-80 E</li> <li>KEEP LEFT AT THE FORK TO CONTINUE ON I-80BL E/US-50 E/CAPITAL CITY</li> <li>FREEWAY, FOLLOW SIGNS FOR INTERSTATE 80 BUSINESS/SACRAMENTO/SOUTH LAKE</li> <li>TAHOE</li> <li>CONTINUE ONTO US-50 E</li> <li>TAKE EXIT 30B TOWARD EL DORADO HILLS BLVD</li> <li>FOLLOW EL DORADO HILLS BLVD AND SALMON FALLS RD TO GATE LN</li> <li>MERGE ONTO LATROBE RD</li> <li>CONTINUE ONTO EL DORADO HILLS BLVD</li> <li>CONTINUE ONTO SALMON FALLS RD</li> <li>TURN RIGHT ONTO GATE LN</li> </ol>	<p>AT&amp;T PROPOSES TO CONSTRUCT A NEW UNMANNED TELECOMMUNICATIONS FACILITY. AT&amp;T WILL INSTALL:</p> <ul style="list-style-type: none"> <li>(1) NEW 15' WIDE GRAVEL ACCESS ROAD</li> <li>(1) NEW 30'X45' FENCED LEASE AREA</li> <li>(1) NEW 6' CHAIN LINK FENCE</li> <li>(1) NEW 12' WIDE DOUBLE ACCESS GATE</li> <li>(1) NEW 153' MONOPINE (TOP OF BRANCHES AT 160')</li> <li>(1) NEW PRE-FAB "WIC" LIGHT WEIGHT EQUIPMENT SHELTER WITH ANCILLARY INTERIOR EQUIPMENT</li> <li>(1) NEW GPS ANTENNA</li> <li>(1) NEW 35 Kw PROPANE GENERATOR</li> <li>(1) LP PROPANE TANK (500 GALLON)</li> <li>(12) NEW ANTENNAS</li> <li>(6) NEW RRUS-11, (3) NEW RRUS-12, (12) NEW RRUS-32</li> <li>(4) NEW SURGE SUPPRESSORS</li> <li>(2) FUTURE 4' M/W DISH</li> </ul>

COORDINATING ENGINEER:

**Peek Site-Com**  
 12852 Earhart Ave. Suite 101  
 Auburn, California 95602  
 Phone (530) 885-6160  
 E-Mail info@peeksitecom.com

OCCUPANCY & CONST. TYPE	SPECIAL INSPECTIONS	APPROVALS	GENERAL CONTRACTOR NOTES																											
<p>OCCUPANCY: U (UNMANNED)            CONSTRUCTION TYPE: V-B</p> <p>ACCESSIBILITY REQUIREMENTS:            THIS FACILITY IS UNMANNED AND NOT FOR HUMAN HABITATION, HANDICAPPED ACCESS REQUIREMENTS ARE NOT REQUIRED IN ACCORDANCE WITH THE 2016 CALIFORNIA BUILDING CODE, CHAPTER 11B, EXCEPTION SECTION 11B-203.5</p>	<p>*SEE SPECIAL INSPECTION FORM</p> <ol style="list-style-type: none"> <li>POST-INSTALLED ANCHORS</li> <li>HIGH STRENGTH BOLTING</li> </ol> <p><b>Attachment 1</b>  <b>Site 6 Zee Estates</b></p>	<table border="1"> <thead> <tr> <th>APPROVED BY:</th> <th>INITIALS:</th> <th>DATE:</th> </tr> </thead> <tbody> <tr> <td>AT&amp;T:</td> <td></td> <td></td> </tr> <tr> <td>VENDOR:</td> <td></td> <td></td> </tr> <tr> <td>R.F.:</td> <td></td> <td></td> </tr> <tr> <td>LEASING/LANDLORD:</td> <td></td> <td></td> </tr> <tr> <td>ZONING:</td> <td></td> <td></td> </tr> <tr> <td>CONSTRUCTION:</td> <td></td> <td></td> </tr> <tr> <td>POWER/TELCO:</td> <td></td> <td></td> </tr> <tr> <td>PG&amp;E:</td> <td></td> <td></td> </tr> </tbody> </table>	APPROVED BY:	INITIALS:	DATE:	AT&T:			VENDOR:			R.F.:			LEASING/LANDLORD:			ZONING:			CONSTRUCTION:			POWER/TELCO:			PG&E:			<p><b>DO NOT SCALE DRAWINGS</b></p> <p>THESE DRAWINGS ARE FORMATTED TO BE FULL SIZE 24"X36". CONTRACTOR SHALL VERIFY ALL PLANS AND EXISTING DIMENSIONS AND CONDITIONS ON THE JOBSITE AND SHALL IMMEDIATELY NOTIFY THE ARCHITECT/ENGINEER IN WRITING OF ANY DISCREPANCIES BEFORE PROCEEDING WITH THE WORK OR MATERIAL ORDERS OR BE RESPONSIBLE FOR THE SAME.</p>
APPROVED BY:	INITIALS:	DATE:																												
AT&T:																														
VENDOR:																														
R.F.:																														
LEASING/LANDLORD:																														
ZONING:																														
CONSTRUCTION:																														
POWER/TELCO:																														
PG&E:																														

SEAL:

SITE #: CVL03629    CHK.: ...    DRAWN BY: RB

SHEET TITLE: TITLE SHEET

SHEET NUMBER: T-1    REVISION: 0

*GENERAL CONSTRUCTION NOTES:*

1. DRAWINGS ARE NOT TO BE SCALED. WRITTEN DIMENSIONS TAKE PRECEDENCE, AND THIS SET OF PLANS IS INTENDED TO BE USED FOR DIAGRAMMATIC PURPOSES ONLY, UNLESS NOTED OTHERWISE. THE GENERAL CONTRACTOR'S SCOPE OF WORK SHALL INCLUDE FURNISHING ALL MATERIALS, EQUIPMENT, LABOR, AND ANYTHING ELSE DEEMED NECESSARY TO COMPLETE INSTALLATIONS AS DESCRIBED HEREIN.
2. PRIOR TO THE SUBMISSION OF BIDS, THE CONTRACTORS INVOLVED SHALL VISIT THE JOB SITE AND FAMILIARIZE THEMSELVES WITH ALL CONDITIONS AFFECTING THE PROPOSED PROJECT, WITH THE CONSTRUCTION AND CONTRACT DOCUMENTS, FIELD CONDITIONS AND CONFIRM THAT THE PROJECT MAY BE ACCOMPLISHED AS SHOWN PRIOR TO PROCEEDING WITH CONSTRUCTION. ANY ERRORS, OMISSIONS, OR DISCREPANCIES ARE TO BE BROUGHT TO THE ATTENTION OF THE ARCHITECT/ENGINEER.
3. THE GENERAL CONTRACTOR SHALL RECEIVE WRITTEN AUTHORIZATION TO PROCEED WITH CONSTRUCTION PRIOR TO STARTING WORK ON ANY ITEM NOT CLEARLY DEFINED BY THE CONSTRUCTION DRAWINGS/ CONTRACT DOCUMENTS.
4. THE CONTRACTOR SHALL SUPERVISE AND DIRECT THE PROJECT DESCRIBED HEREIN. THE CONTRACTOR SHALL BE SOLELY RESPONSIBLE FOR ALL CONSTRUCTION MEANS, METHODS, TECHNIQUES, SEQUENCES AND PROCEDURES AND FOR COORDINATING ALL PORTIONS OF THE WORK UNDER THE CONTRACT.
5. THE CONTRACTOR SHALL INSTALL ALL EQUIPMENT AND MATERIALS ACCORDING TO MANUFACTURER'S/ VENDOR'S SPECIFICATIONS UNLESS NOTED OTHERWISE OR WHERE LOCAL CODES OR ORDINANCES TAKE PRECEDENCE.
6. ALL WORK PERFORMED ON PROJECT AND MATERIALS INSTALLED SHALL BE IN STRICT ACCORDANCE WITH ALL APPLICABLE CODES, REGULATIONS, AND ORDINANCES. CONTRACTOR SHALL GIVE ALL NOTICES AND COMPLY WITH ALL LAWS, ORDINANCES, RULES, REGULATIONS AND LAWFUL ORDERS OF ANY PUBLIC AUTHORITY, MUNICIPAL AND UTILITY COMPANY SPECIFICATIONS, AND LOCAL AND STATE JURISDICTIONAL CODES BEARING ON THE PERFORMANCE OF THE WORK.
7. GENERAL CONTRACTOR SHALL PROVIDE AT THE PROJECT SITE A FULL SET OF CONSTRUCTION DOCUMENTS UPDATED WITH THE LATEST REVISIONS AND ADDENDUMS OR CLARIFICATIONS FOR THE USE BY ALL PERSONNEL INVOLVED WITH THE PROJECT.
8. THE STRUCTURAL COMPONENTS OF THIS PROJECT SITE/ FACILITY ARE NOT TO BE ALTERED BY THIS CONSTRUCTION PROJECT UNLESS NOTED OTHERWISE.
9. DETAILS INCLUDED HEREIN ARE INTENDED TO SHOW END RESULT OF DESIGN. MINOR MODIFICATIONS MAY BE REQUIRED TO SUIT JOB CONDITIONS OR SITUATIONS, AND SUCH MODIFICATIONS SHALL BE INCLUDED AS PART OF THE SCOPE OF WORK.
10. SEAL PENETRATIONS THROUGH FIRE-RATED AREAS WITH U.L. LISTED OR FIRE MARSHALL APPROVED MATERIALS IF APPLICABLE TO THIS FACILITY AND OR PROJECT SITE.
11. PROVIDE A PORTABLE FIRE EXTINGUISHER WITH A RATING OF NOT LESS THAN 2-A OR 2-A10BC WITHIN 75 FEET TRAVEL DISTANCE TO ALL PORTIONS OF THE PROJECT AREA DURING CONSTRUCTION.
12. THE CONTRACTOR SHALL MAKE NECESSARY PROVISIONS TO PROTECT EXISTING IMPROVEMENTS, EASEMENTS, PAVING, CURBING, ETC. DURING CONSTRUCTION. UPON COMPLETION OF WORK, CONTRACTOR SHALL REPAIR ANY DAMAGE THAT MAY HAVE OCCURRED DUE TO CONSTRUCTION ON OR ABOUT THE PROPERTY.
13. CONTRACTOR SHALL SEE TO IT THAT GENERAL WORK AREA IS KEPT CLEAN AND HAZARD FREE DURING CONSTRUCTION AND DISPOSE OF ALL DIRT, DEBRIS, RUBBISH AND REMOVE EQUIPMENT NOT SPECIFIED AS REMAINING ON THE PROPERTY. PREMISES SHALL BE LEFT IN CLEAN CONDITION AND FREE FROM PAINT SPOTS, DUST, OR SMUDGES OF ANY NATURE.
14. THE ARCHITECTS/ENGINEERS HAVE MADE EVERY EFFORT TO SET FORTH IN THE CONSTRUCTION AND CONTRACT DOCUMENTS THE COMPLETE SCOPE OF WORK. CONTRACTORS BIDDING THE JOB ARE NEVERTHELESS CAUTIONED THAT MINOR OMISSIONS OR ERRORS IN THE DRAWINGS AND OR SPECIFICATIONS SHALL NOT EXCUSE SAID CONTRACTOR FROM COMPLETING THE PROJECT AND IMPROVEMENTS IN ACCORDANCE WITH THE INTENT OF THESE DOCUMENTS. THE BIDDER SHALL BEAR THE RESPONSIBILITY OF NOTIFYING (IN WRITING) THE ARCHITECT/ENGINEER OF ANY CONFLICTS, ERRORS, OR OMISSIONS PRIOR TO THE SUBMISSION OF CONTRACTOR'S PROPOSAL. IN THE EVENT OF DISCREPANCIES THE CONTRACTOR SHALL PRICE THE MORE COSTLY OR EXTENSIVE WORK, UNLESS DIRECTED OTHERWISE.

*ABBREVIATIONS*

ABV.	ABOVE	L.F.	LINEAR FEET (FOOT)
ADD'L	ADDITIONAL	MAX.	MAXIMUM
A.G.L.	ABOVE GROUND LEVEL	M.B.	MACHINE BOLT
ALUM.	ALUMINUM	MECH.	MECHANICAL
APPROX.	APPROXIMATELY	MFR.	MANUFACTURER
AWG.	AMERICAN WIRE GAUGE	MIN.	MINIMUM
BLDG.	BUILDING	MISC.	MISCELLANEOUS
BLK.	BLOCKING	MTL	METAL
CAB.	CABINET	(N)	NEW
CONC.	CONCRETE	NO. (#)	NUMBER
CONN.	CONNECTION(OR)	N.T.S.	NOT TO SCALE
CONST.	CONSTRUCTION	O.C.	ON CENTER
CONT.	CONTINUOUS	P/C	PRECAST CONCRETE
DBL	DOUBLE	PPC	POWER PROTECTION CABINET
DEPT.	DEPARTMENT	P.S.F.	POUNDS PER SQUARE FOOT
D.F.	DOUGLAS FIR	P.S.I.	POUNDS PER SQUARE INCH
DIA.	DIAMETER	P.T.	PRESSURE TREATED
DIM.	DIMENSION	QTY.	QUANTITY
EA.	EACH	RAD. (R)	RADIUS
EL.	ELEVATION	REF.	REFERENCE
ELEC.	ELECTRICAL	REINF.	REINFORCEMENT(ING)
EMT.	ELECTRICAL METALLIC TUBING	REQ'D	REQUIRED
ENG.	ENGINEER	RGS	RIGID GALVANIZED STEEL
EQ.	EQUAL	SCH.	SCHEDULE
(E)	EXISTING	SHT.	SHEET
EXT.	EXTERIOR	SPEC.	SPECIFICATIONS
FAB.	FABRICATION	SQ.	SQUARE
F.A.	FINISHED FLOOR	S.S.	STAINLESS STEEL
F.B.	FINISHED GRADE	STD.	STANDARD
FT. (')	FOOT (FEET)	STL	STEEL
FTG.	FOOTING	STRUC.	STRUCTURAL
GA.	GAUGE	TEMP.	TEMPORARY
GALV.	GALVANIZE(D)	T.O.A.	TOP OF ANTENNAS
G.F.I.	GROUND FAULT CIRCUIT INTERRUPTER	T.O.F.	TOP OF FOUNDATION
GPS	GLOBAL POSITIONING SYSTEM	T.O.P.	TOP OF PLATE (PARAPET)
GRND.	GROUND(ING)	T.O.W.	TOP OF WALL
HT.	HEIGHT	TYP.	TYPICAL
ICGB.	ISOLATED COPPER GROUND BUS	U/G	UNDER GROUND
IN. (")	INCH(ES)	V.I.F.	VERIFY IN FIELD
INT.	INTERIOR	W	WIDE (WIDTH)
L.B.	LAG BOLTS	W/	WITH
		WT.	WEIGHT

*SYMBOLS LEGEND*

	WOOD FENCE
	CHAIN LINK FENCE
	HIDDEN LINE
	COAX/POWER/FIBER CONDUIT
	PROPERTY LINE
	ELEVATION DATUM
	EARTH
	CONCRETE
	SAND
	GRATE PLATFORM
	GRAVEL
	FRP (FIBERGLASS REINFORCED PLASTIC)
	NEW DC SURGE SUPPRESSOR
	NEW ANTENNA
	NEW RRU

PROPRIETARY INFORMATION

THE INFORMATION CONTAINED IN THIS SET OF DRAWINGS IS PROPRIETARY BY NATURE. ANY USE OR DISCLOSURE OTHER THAN THAT WHICH RELATES TO PEEK SITE-COM IS STRICTLY PROHIBITED

CLIENT:



5001 EXECUTIVE PKWY  
SAN RAMON, CA 94583

PROJECT INFORMATION:

**ZEE ESTATES**

GATE LANE 1,000' SOUTH EAST OF THE INTERSECTION OF GATE LANE AND SALMON FALLS ROAD  
PILOT HILL, CA 95664

REV: = DATE: = DESCRIPTION: = BY: =

REV	DATE	DESCRIPTION	BY
1	6-29-17	90% ZONING DOC'S	RB
1	8-3-17	90% ZONING DOC'S	ALP
2	8-9-17	100% ZONING DOC'S	ALP

COORDINATING ENGINEER:

*Peek Site-Com*  

 12852 Earhart Ave. Suite 101  
 Auburn, California 95602  
 Phone (530) 885-6160  
 E-Mail info@peeksitecom.com

SEAL:



SITE #:                      CHK.:                      DRAWN BY:

CVL03629	...	RB
----------	-----	----

SHEET TITLE:

*GENERAL NOTES*

SHEET NUMBER:                      REVISION:

**GN-1 0**



This Site Operated by:  
**AT&T MOBILITY**  
 2600 CAMINO RAMON, 4W850 N  
 SAN RAMON, CA 94583  
 IN CASE OF FIRE AND THE NEED FOR SHUTDOWN  
 TO DEACTIVATE ANTENNAS CALL  
 THE FOLLOWING NUMBER:  
 For 24 Hour Emergency Contact and Access Please Call:  
 (800) 832-6662

Reference Site#: **CVL03629**  
 Site Address: **860 GATE LN. PILOT HILL, CA 95664**

**FENCED COMPOUND SIGNAGE**

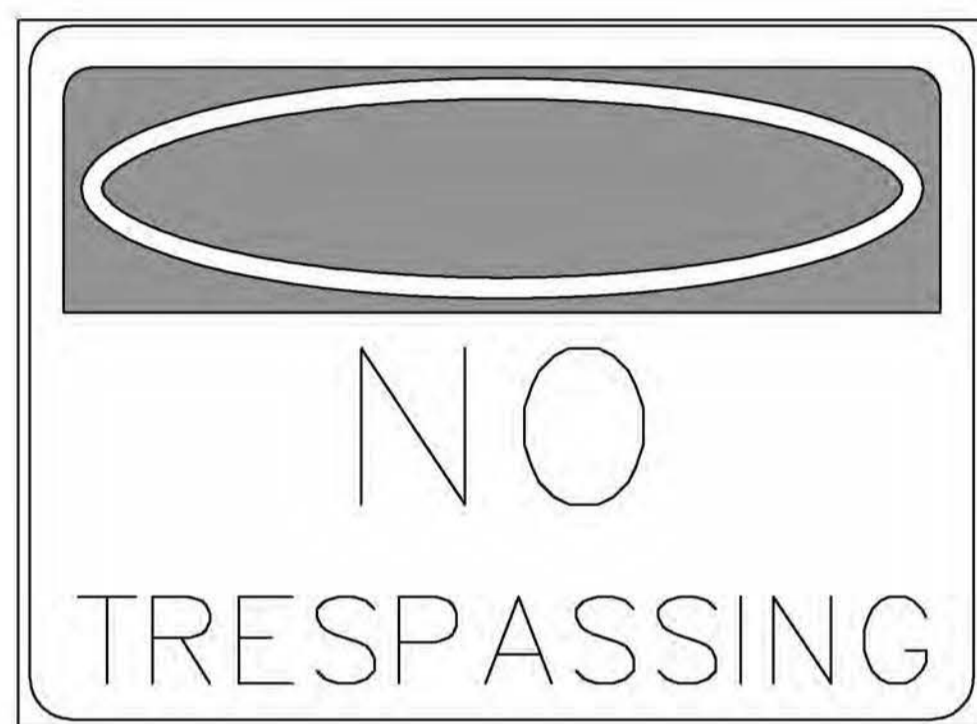

**FENCED COMPOUND SIGNAGE**



**DOOR/EQUIPMENT SIGN**

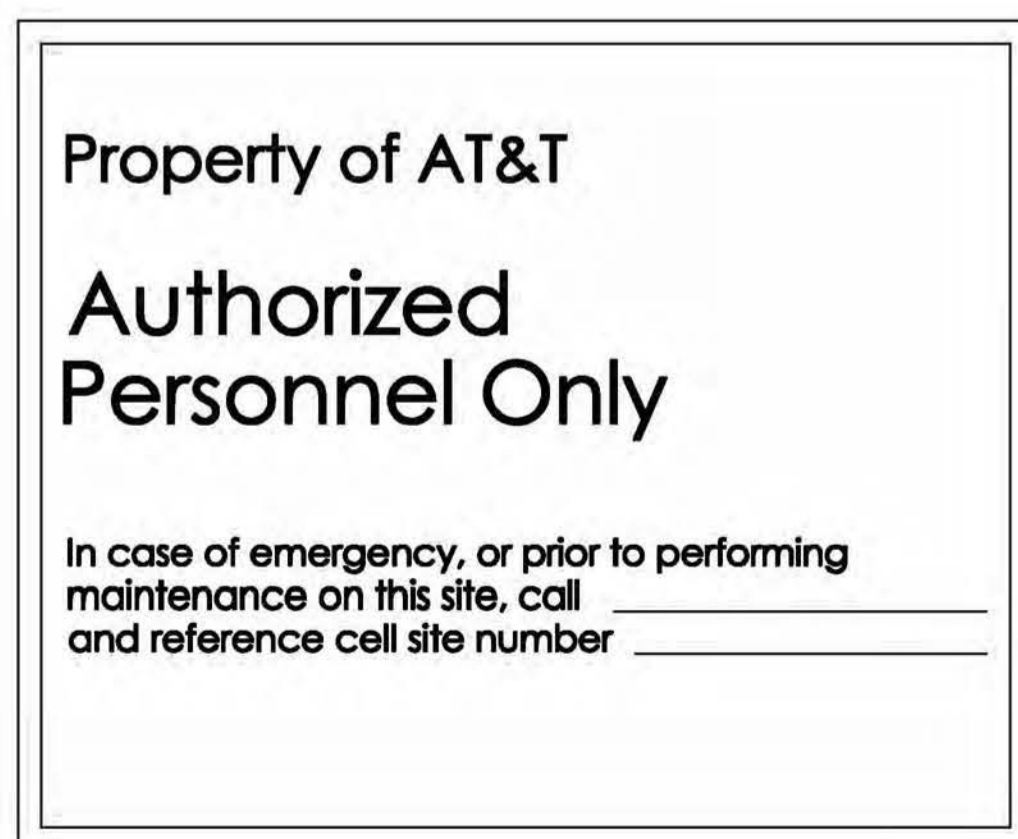

**SHELTER/CABINET DOORS SIGNAGE**

**INFORMATION**

AT&T MOBILITY OPERATES TELECOMMUNICATION ANTENNAS AT THIS LOCATION. REMAIN AT LEAST 3 FEET AWAY FROM ANY ANTENNA AND OBEY ALL POSTED SIGNS.

CONTACT THE OWNER(S) OF THE ANTENNA(S) BEFORE WORKING CLOSER THAN 3 FEET FROM THE ANTENNA(S).

CONTACT AT&T MOBILITY AT 800-368-2822 PRIOR TO PERFORMING ANY MAINTENANCE OR REPAIRS NEAR AT&T MOBILITY ANTENNAS.

THIS IS SITE # **CVL03629**.

CONTACT THE MANAGEMENT OFFICE IF THIS DOOR/HATCH/GATE IS FOUND UNLOCKED.

**INFORMACION**

EN ESTA PROPIEDAD SE UBICAN ANTENAS DE TELECOMUNICACIONES OPERADAS POR AT&T. FAVOR MANTENER UNA DISTANCIA DE NO MENOS DE 3 PIES Y OBEDECER TODOS LOS AVISOS.

COMUNIQUESE CON EL PROPIETARIO O LOS PROPIETARIOS DE LAS ANTENNAS ANTES DE TRABAJAR O CAMINAR DE MENOS DE 3 PIES DE LA ANTENA.

COMUNIQUESE CON AT&T MOBILITY 800-368-2822 ANTES DE REALIZAR CUALQUIER MANTENIMIENTO O REPARACION DE LAS ANTENNAS DE AT&T MOBILITY.

ESTA ES LA ESTACION BASE NUMERO **CVL03629**.

FAVOR COMUNICARSE CON LA OFICINA DE LA ADMINISTRACION DEL EDIFICIO SI ESTA PUERTA O CIERRE SE ENCUENTRA SIN CERRADO.

INFORMATION SIGN 1-1

**INFORMATION**

ACTIVE ANTENNAS ARE MOUNTED

ON THE OUTSIDE FACE OF THIS BUILDING

INFORMATION SIGN 1-2

ON THIS STRUCTURE

STAY BACK A MINIMUM OF 3 FEET FROM THESE ANTENNAS

CONTACT AT&T MOBILITY AT 800-368-2822 & FOLLOW THEIR INSTRUCTIONS PRIOR TO PERFORMING ANY MAINTENANCE OR REPAIRS CLOSER THAN 3 FEET FROM THE ANTENNAS

THIS IS AT&T MOBILITY SITE **CVL03629**

INFORMATION SIGN 1-2

**at&t**

INFORMATION SIGN 1-3

1-1/2"

2"

24"

STAY BACK 3 FEET FROM ANTENNA

INFORMATION SIGN 1-4

- CONTRACTOR SHALL INSTALL ALL INFORMATION SIGNAGE IN ACCORDANCE W/ AT&T WIRELESS DOCUMENT #03-0074, RF EXPOSURE POLICY AND RF SAFETY COMPLIANCE PROGRAM, LATEST EDITION.
- FABRICATION:
  - \*SIGN 1-1: ENTRANCE DOOR, SEE DETAIL 1A, THIS SHEET
  - \*SIGN 1-2: SIGN 1 IS TO BE MADE ON THE 50 MIL ALUMINUM SHEETING (SIZE 8 INCHES BY 12 INCHES) W/ (4) 1/4 INCH MOUNTING HOLES, ONE EACH CORNER OF THE SIGN FOR MOUNTING W/ HARDWARE W/ THE WRAPS. THE MAIN BACKGROUND COLOR IS THE BE WHITE FRONT & BACK W/ BLACK LETTERING
  - THE INFORMATION BAND SHALL BE 1.2 INCH SOLID GREEN BAND W/ 0.5 INCH HIGH BLACK LETTERING. THE BODY OF THE TEXT SHALL BE IN BLACK LETTERING W/ 0.2 INCH HIGH LETTERS. THE REF LINE SHALL BE IN 1/8 INCH LETTERS.
  - THE PLACEMENT OF TEXT SHALL BE DONE IN A MANNER THAT WILL PERMIT EASY READING FROM A DISTANCE OF APPROXIMATELY 6 FEET IN FRONT OF THE SIGN.
  - ALL PAINT WILL BE BAKER W/ ENAMEL W/ UV PROTECTIVE COATING OVER THE FACE OF THE SIGN.

- \*SIGN 1-2 POLE, SEE DETAIL 1B, THIS SHEET.
- SIGN 2 MUST BE A NON METALLIC LABEL W/ AN ADHESIVE BACKING, THE LABEL SHALL BE MADE USING VINYL OR SIMILAR WEATHERPROOF MATERIAL, THE LABEL SHALL BE APPROXIMATELY 5X7 INCHES W/ A WHITE BACKGROUND AND BLACK LETTERING. THE GREEN BAND SHALL BE 1.375 INCH IN HEIGHT & THE LETTERING SHALL BE BLACK W/ 0.75 INCH HIGH LETTERS. THE TEXT LETTERING SHALL BE BLACK W/ 1/8 INCH HIGH LETTERS. UV PROTECTION SHALL BE PLACED OVER THE FRONT OF THE LABEL.
- \*SIGN 1-3: BACK OF ANTENNAS, SEE DETAIL 1C & 3, THIS SHEET
- \*SIGN 3 IS A 1 INCH X 2 INCH PANEL THAT CAN BE APPLIED TO THE BACK OR SIDE OF AN ANTENNA TO IDENTIFY IT AS AN AT&T ANTENNA.
- \*SIGN 1-4: SIDE OF ANTENNAS, SEE DETAIL 1D & 3, THIS SHEET
- SIGN 4 IS MADE FROM TRANSPARENT MATERIAL 1-1/2 INCHES WIDE & 24 INCHES LONG. THE LETTERING IS TO BE BLACK W/ 1/2 INCH LETTERING IN A VERTICAL COLUMN. THE SPACING BETWEEN WORDS MUST BE SUCH THAT IT IS EASILY READ & FILLS THE LENGTH OF THE SIGN

**INFORMATION SIGNAGE**

**INFORMATION**

Federal Communications Commission  
Tower Registration Number

**1 2 3 4 5 6 7**

Posted in accordance with federal Communications Commission rules and antenna tower registration 47CFR 17.4(g).

**FCC ASR SIGNAGE**

Property of AT&T

**Authorized Personnel Only**

No Trespassing  
Violators will be Prosecuted

In case of emergency, or prior to performing maintenance on this site, call \_\_\_\_\_ and reference cell site number \_\_\_\_\_

**GATE SIGNAGE**

- NOTE:
- CONTRACTOR SHALL INSTALL ALL INFORMATION SIGNAGE IN ACCORDANCE W/ AT&T WIRELESS DOCUMENT #03-0074, RF EXPOSURE POLICY AND RF SAFETY COMPLIANCE PROGRAM, LATEST EDITION.
  - CONTRACTOR SHALL CONTACT AT&T R-RFSC FOR INFORMATION ON MPE LEVELS AND INSTRUCTIONS ON LEVEL AND LOCATION OF SIGNAGE.

**WARNING**

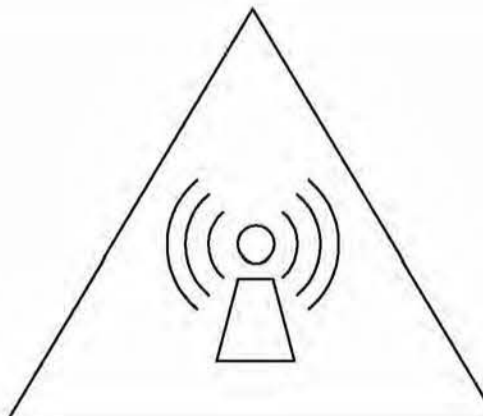

**Beyond This Point you are entering a controlled area where RF Emissions exceed the FCC Controlled Exposure limits**  
 Failure to obey all posted signs and site guidelines could result in serious injury

Ref: FCC 47CFR 1.1307(b)

**CAUTION**

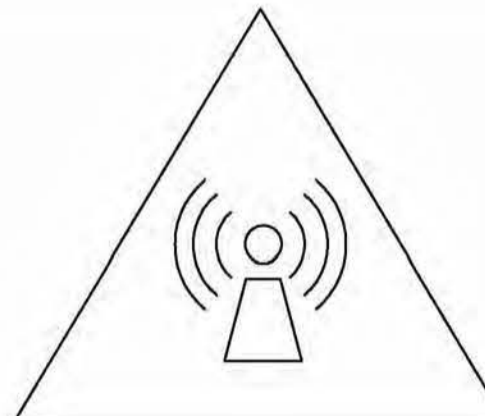

**Beyond This Point you are entering a controlled area where RF Emissions may exceed the FCC Controlled Exposure limits**  
 Obey all posted signs and site guidelines for working in an RF environment

Ref: FCC 47CFR 1.1307(b)

**CAUTION AND WARNING SIGN**

**SIGNAGE AND STRIPING INFORMATION**

- THE FOLLOWING INFORMATION IS A GUIDELINE W/ RESPECT TO PREVAILING STANDARDS LIMITING HUMAN EXPOSURE TO RADIO FREQUENCY ENERGY AND SHOULD BE USED AS SUCH. IF THE SITE'S EMF REPORT OR ANY LOCAL, STATE OR FEDERAL GUIDELINES OR REGULATIONS SHOULD BE IN CONFLICT W/ ANY PART OF THESE NOTES OR PLANS, THE MORE RESTRICTIVE GUIDELINE OR REGULATION SHALL BE FOLLOWED AND OVERRIDE THE LESSER.
- THE PUBLIC LIMIT OF RF EXPOSURE ALLOWED BY AT&T IS 1MWCM<sup>2</sup> AND THE OCCUPATIONAL LIMIT OF RF EXPOSURE ALLOWED BY AT&T IS 5MWCM<sup>2</sup>
- IF THE BOTTOM OF THE ANTENNA IS MOUNTED (8) EIGHT FEET ABOVE THE GROUND OR WORKING PLATFORM LINE OF THE PERSONAL COMMUNICATION SYSTEM (PCS) AND DOES NOT EXCEED THE PUBLIC LIMIT OF RF EXPOSURE LIMIT THEN NO STRIPING OR BARRICADES SHOULD BE NEEDED.
- IF THE PUBLIC LIMIT OF RF EXPOSURE ON THE SITE IS EXCEEDED AND THE AREA IS PUBLICLY ACCESSIBLE (E.G. ROOF ACCESS DOOR THAT CANNOT BE LOCKED, OR FIRE EGRESS) THEN BOTH BARRICADES AND STRIPING SHALL BE PLACED AROUND THE ANTENNAS. THE EXACT EXTENT OF THE BARRICADES AND STRIPING SHALL BE DETERMINED BY THE EMF REPORT FOR THE SITE DONE BEFORE OR SHORTLY AFTER COMPLETION OF SITE CONSTRUCTION. USE THE PLANS AS A GUIDELINE FOR PLACEMENT OF SUCH BARRICADES AND STRIPING.
- IF THE PUBLIC LIMIT OF RF EXPOSURE ON THE SITE IS EXCEEDED AND THE AREA IS PUBLICLY ACCESSIBLE (E.G. ROOF ACCESS DOOR THAT CANNOT BE LOCKED, OR FIRE EGRESS) THEN BOTH BARRICADES AND STRIPING SHALL BE PLACED AROUND THE ANTENNAS. THE EXACT EXTENT OF THE BARRICADES & STRIPING SHALL BE DETERMINED BY THE EMF REPORT FOR THE SITE DONE BEFORE OR SHORTLY AFTER COMPLETION OF SITE CONSTRUCTION. USE THE PLANS AS A GUIDELINE FOR PLACEMENT OF SUCH BARRICADES AND STRIPING.
- ALL TRANSMIT ANTENNAS REQUIRE A THREE LANGUAGE WARNING SIGN WRITTEN IN ENGLISH, SPANISH, AND CHINESE. THIS SIGN SHALL BE PROVIDED TO THE CONTRACTOR BY THE AT&T CONSTRUCTION PROJECT MANAGER AT THE TIME OF CONSTRUCTION. THE LARGER SIGN SHALL BE PLACED IN PLAIN SIGHT AT ALL ROOF ACCESS LOCATIONS AND ON ALL BARRICADES. THE SMALLER SIGN SHALL BE PLACED ON THE ANTENNA ENCLOSURES IN A MANNER THAT IS EASILY SEEN BY ANY PERSON ON THE ROOF. WARNING SIGNS SHALL COMPLY W/ ANSI C95.2 COLOR, SYMBOL, AND CONTENT CONVENTIONS. ALL SIGNS SHALL HAVE AT&T'S NAME AND THE COMPANY CONTACT INFORMATION (E.G. TELEPHONE NUMBER) TO ARRANGE FOR ACCESS TO THE RESTRICTED AREAS. THIS TELEPHONE NUMBER SHALL BE PROVIDED TO THE CONTRACTOR BY THE AT&T CONSTRUCTION PROJECT MANAGER AT THE TIME OF CONSTRUCTION.
- PHOTOS OF ALL STRIPING, BARRICADES & SIGNAGE SHALL BE PART OF THE CONTRACTORS CLOSE OUT PACKAGE & SHALL BE TURNED INTO THE AT&T CONSTRUCTION PACKAGE & SHALL BE TURNED INTO THE AT&T CONSTRUCTION PROJECT MANAGER AT THE END OF CONSTRUCTION. STRIPING SHALL BE DONE W/ FADE RESISTANT YELLOW SAFETY PAINT IN A CROSS-HATCH PATTERN AS DETAILED BY THE CONSTRUCTION DRAWINGS. ALL BARRICADES SHALL BE MADE OF AN RF FRIENDLY MATERIAL SO AS NOT TO BLOCK OR INTERFERE W/ THE OPERATION OF THE ANTENNAS. BARRICADES SHALL BE PAINTED W/ FADE RESISTANT YELLOW SAFETY PAINT. THE CONTRACTOR SHALL PROVIDE ALL RF FRIENDLY BARRICADES NEEDED, & SHALL PROVIDE THE AT&T CONSTRUCTION PROJECT MANAGER W/ A DETAILED
- SHOP DRAWING OF EACH BARRICADE. UPON CONSTRUCTION COMPLETION.

**GENERAL NOTES**

**NOTICE**

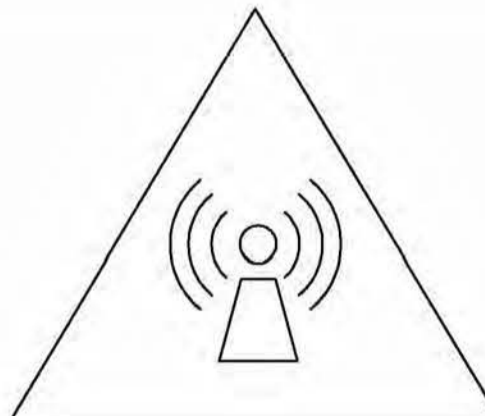

**Beyond This Point you are entering an area where RF Emissions may exceed the FCC General Population Exposure Limits**  
 Follow all posted signs and site guidelines for working in an RF environment

Ref: FCC 47CFR 1.1307(b)

**NOTICE SIGN**

PROPRIETARY INFORMATION

THE INFORMATION CONTAINED IN THIS SET OF DRAWINGS IS PROPRIETARY BY NATURE. ANY USE OR DISCLOSURE OTHER THAN THAT WHICH RELATES TO PEEK SITE-COM IS STRICTLY PROHIBITED

CLIENT:



5001 EXECUTIVE PKWY  
SAN RAMON, CA 94583

PROJECT INFORMATION:

**ZEE ESTATES**

GATE LANE 1,000' SOUTH EAST OF THE INTERSECTION OF GATE LANE AND SALMON FALLS ROAD  
PILOT HILL, CA 95664

REV: = DATE: DESCRIPTION: BY:

1	6-29-17	90% ZONING DOC'S	RB
2	8-3-17	90% ZONING DOC'S	ALP
1	8-9-17	100% ZONING DOC'S	ALP

COORDINATING ENGINEER:

**Peek Site-Com**

12852 Earhart Ave. Suite 101  
Auburn, California 95602  
Phone (530) 885-6160  
E-Mail info@peeksitcom.com

SEAL:



SITE #: CVL03629    CHK.: ...    DRAWN BY: RB

SHEET TITLE: **SITE SIGNAGE**

SHEET NUMBER: **GN-2**    REVISION: **0**

THESE DRAWINGS AND/OR THE ACCOMPANYING SPECIFICATION AS INSTRUMENTS OF SERVICE, ARE THE EXCLUSIVE PROPERTY OF GEIL ENGINEERING AND THEIR USE AND PUBLICATION SHALL BE RESTRICTED TO THE ORIGINAL SITE AND CARRIER FOR WHICH THEY ARE PREPARED. REUSE, REPRODUCTION OR PUBLICATION BY ANY METHOD, IN WHOLE OR IN PART, IS PROHIBITED EXCEPT BY WRITTEN PERMISSION FROM GEIL ENGINEERING TITLE TO THESE PLANS AND/OR SPECIFICATIONS SHALL REMAIN WITH GEIL ENGINEERING WITHOUT PREJUDICE AND VISUAL CONTACT WITH THEM SHALL CONSTITUTE PRIMA FACIE EVIDENCE OF ACCEPTANCE OF THESE RESTRICTIONS.

BOUNDARY SHOWN IS BASED ON MONUMENTATION FOUND AND RECORD INFORMATION. THIS IS NOT A BOUNDARY SURVEY. THIS IS A SPECIALIZED TOPOGRAPHIC MAP WITH PROPERTY LINES AND EASEMENTS BEING A GRAPHIC DEPICTION BASED ON INFORMATION GATHERED FROM VARIOUS SOURCES OF RECORD AND AVAILABLE MONUMENTATION FOUND DURING THE FIELD SURVEY. NO EASEMENTS WERE RESEARCHED OR PLOTTED. PROPERTY LINES AND LINES OF TITLE WERE NOT INVESTIGATED NOR SURVEYED. NO PROPERTY MONUMENTS WERE SET.

DATE OF SURVEY: 04-17-17  
 SURVEYED BY OR UNDER DIRECTION OF: KENNETH D. GEIL, R.C.E. 14803  
 LOCATED IN THE COUNTY OF EL DORADO, STATE OF CALIFORNIA  
 BEARINGS SHOWN ARE BASED UPON MONUMENTS FOUND AND RECORD INFORMATION. THIS IS NOT A BOUNDARY SURVEY.  
 ELEVATIONS SHOWN ON THIS PLAN ARE BASED UPON U.S.G.S. N.A.V.D. 88 DATUM. ABOVE MEAN SEA LEVEL.  
 N.G.V.D. 1929 CORRECTION: SUBTRACT 2.62' FROM ELEVATIONS SHOWN.  
 CONTOUR INTERVAL: 1'  
 CONTRACTOR IS RESPONSIBLE TO VERIFY LEASE AREA PRIOR TO CONSTRUCTION.  
 ASSESSOR'S PARCEL NUMBER: 104-370-24-100  
 OWNER(S): WOLFE FAMILY TRUST  
 9289 SHADOW BROOK PLACE  
 GRANITE BAY, CA 95746

Lease Area Description  
 All that certain lease area being a portion of the North 1/2 of Lot 7 as is shown on that certain Parcel Map filed for record at Book 13 of Parcel Maps, Page 106, El Dorado County Records, located in the County of El Dorado, State of California, and being a portion of Section 18, Township 11 N., Range 9 E., M.D.B. & M, and being more particularly described as follows:  
 Commencing at a 1-1/2" Capped Iron Pipe monument set at the Northeast corner of Parcel B as is shown on that certain Parcel Map filed for record at Book 21 of Parcel Maps at Page 34, Official Records of El Dorado County, from which a similar monument set West 442.06 feet from the Southeast corner of said parcel bears South 26°22'17" West 998.99 feet; thence from said point of commencement North 09°35'24" East 320.91 feet to the True Point of Beginning; thence from said True Point of Beginning North 46°36'50" East 45.00 feet; thence North 43°23'10" West 30.00 feet; thence South 46°36'50" West 45.00 feet; thence South 43°23'10" East 30.00 feet to the point of beginning.  
 Together with a non-exclusive easement for access and utility purposes fifteen feet in width the centerline of which is described as follows: beginning at a point which bears South 43°23'10" East 7.50 feet from the Southeast corner of the above described lease area and running thence South 46°36'50" West 27.43 feet; thence through a tangent curve to the left having a radius of 20.00 feet through an arc distance of 31.20 feet; thence South 42°46'14" East 46.11 feet; thence through a tangent curve to the left having a radius of 20.00 feet through an arc distance of 27.54 feet; thence North 58°20'12" East 34.31 feet; thence through a tangent curve to the right having a radius of 30.00 feet through an arc distance of 3.53 feet; thence North 65°04'17" East 25.36 feet; thence through a tangent curve to the left having a radius of 30.00 feet through an arc distance of 10.13 feet; thence North 45°43'15" East 32.48 feet to a point on the centerline of the road commonly known as "Gate Lane" and running thence over and across said Lane as is shown hereon to the public right of way more commonly known as Salmon Falls Road.

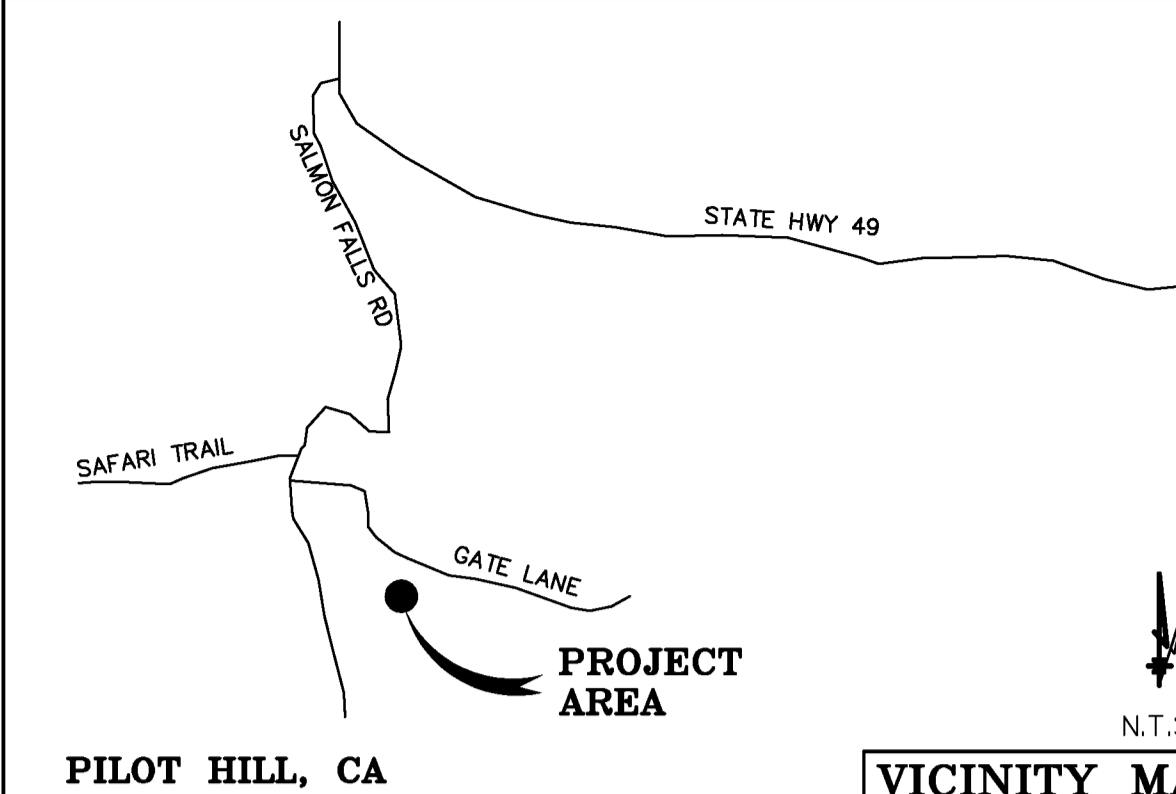

PILOT HILL, CA  
 VICINITY MAP  
 Geil Engineering  
 Engineering \* Surveying \* Planning  
 1226 High Street  
 Auburn, California 95603-5015  
 Phone: (530) 885-0426 \* Fax: (530) 823-1309

A.T. & T. Mobility  
 Project No./Name: CVL03629 / ZEE ESTATES  
 Project Site Location: Gate Lane 1,000' South East of the Intersection of Gate Lane and Salmon Falls Road  
 Pilot Hill, CA 95664  
 El Dorado County  
 Date of Observation: 04-17-17  
 Equipment/Procedure Used to Obtain Coordinates: Trimble Pathfinder Pro XL post processed with Pathfinder Office software.  
 Type of Antenna Mount: Proposed Monopine Tower  
 Coordinates (Tower)  
 Latitude: N 38° 48' 36.47" (NAD83) N 38° 48' 36.83" (NAD27)  
 Longitude: W 121° 01' 13.05" (NAD83) W 121° 01' 09.25" (NAD27)  
 ELEVATION of Ground at Structure (NAVD88) 1563' AMSL  
 CERTIFICATION: I, the undersigned, do hereby certify elevation listed above is based on a field survey done under my supervision and that the accuracy of those elevations meet or exceed 1-A Standards as defined in the FAA ASAC Information Sheet 91:003, and that they are true and accurate to the best of my knowledge and belief.  
 Kenneth D. Geil California RCE 14803

DEPT	APPROVED	DATE
ARC		
RE		
INT		
EE/IN		
OPS		
EE/OUT		

Surveyor  
**GEIL ENGINEERING**  
 ENGINEERING \* SURVEYING \* PLANNING  
 1226 HIGH STREET  
 AUBURN, CALIFORNIA 95603  
 Phone: (530) 885-0426  
 Fax: (530) 823-1309

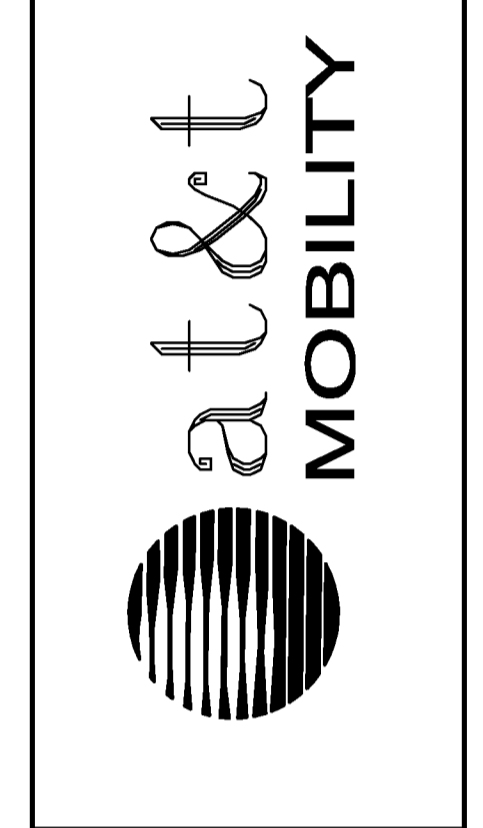

**CVL03629 ZEE ESTATES**  
**GATE LANE 1,000' SOUTH EAST OF THE INTERSECTION OF GATE LANE AND SALMON FALLS ROAD**  
**PILOT HILL, CA 95664**  
**PLOT PLAN AND SITE TOPOGRAPHY**

REVISIONS	DATE	DESCRIPTION
REV	04-18-17	PRELIMINARY DRAWING
REV	05-08-17	LEASE AREA DELETED
REV	08-18-17	ADDRESS CHANGE
REV		
REV		

Sheet  
**C-1**

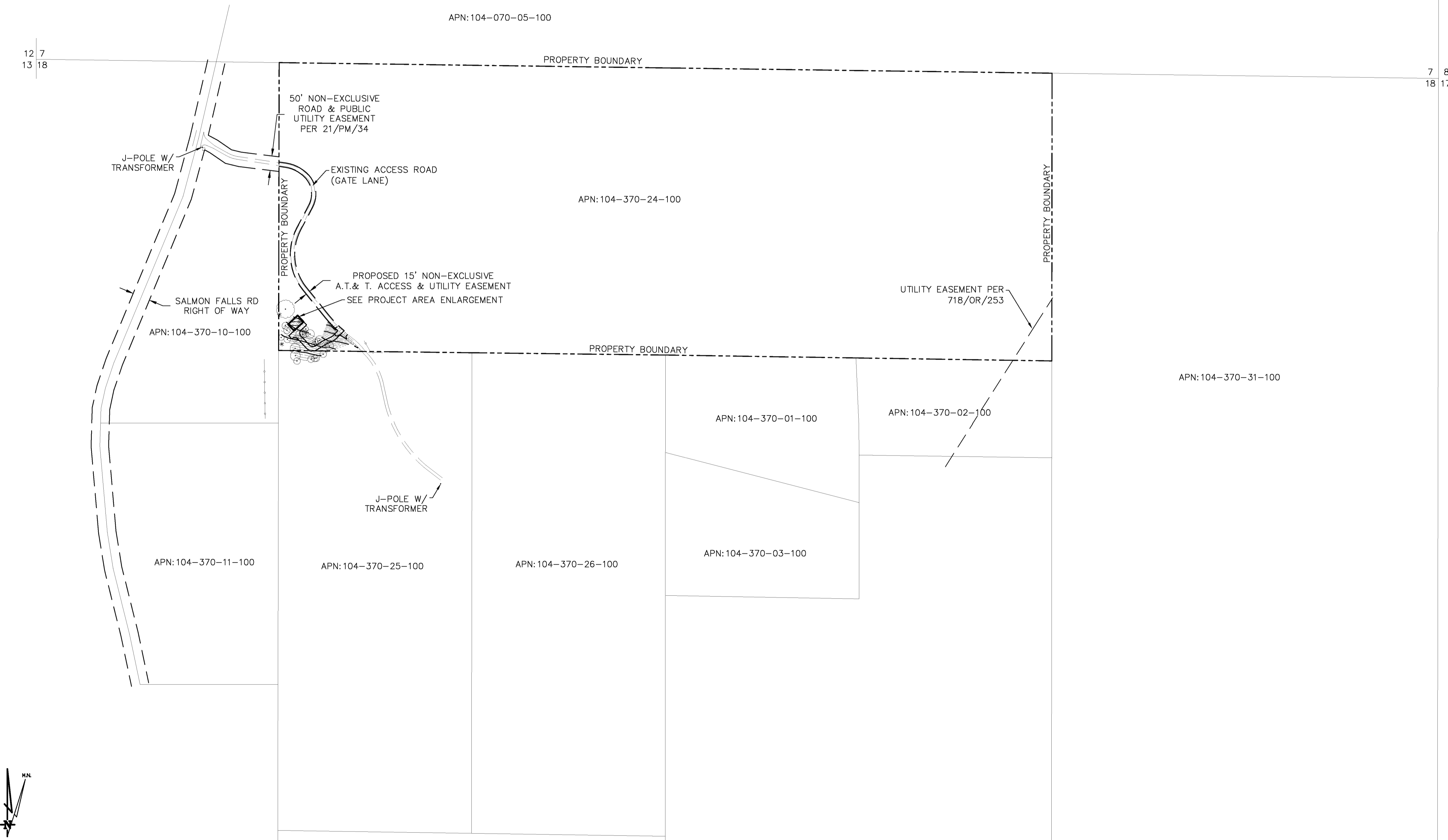

SCALE 1" = 200'

OVERALL SITE PLAN

THESE DRAWINGS AND/OR THE ACCOMPANYING SPECIFICATION AS INSTRUMENTS OF SERVICE, ARE THE EXCLUSIVE PROPERTY OF GEIL ENGINEERING AND THEIR USE AND PUBLICATION SHALL BE RESTRICTED TO THE ORIGINAL SITE AND CARRIER FOR WHICH THEY ARE PREPARED. REUSE, REPRODUCTION OR PUBLICATION BY ANY METHOD, IN WHOLE OR IN PART, IS PROHIBITED EXCEPT BY WRITTEN PERMISSION FROM GEIL ENGINEERING TITLE TO THESE PLANS AND/OR SPECIFICATIONS SHALL REMAIN WITH GEIL ENGINEERING WITHOUT PREJUDICE AND VISUAL CONTACT WITH THEM SHALL CONSTITUTE PRIMA FACIE EVIDENCE OF ACCEPTANCE OF THESE RESTRICTIONS.

BOUNDARY SHOWN IS BASED ON MONUMENTATION FOUND AND RECORD INFORMATION. THIS IS NOT A BOUNDARY SURVEY. THIS IS A SPECIALIZED TOPOGRAPHIC MAP WITH PROPERTY LINES AND EASEMENTS BEING A GRAPHIC DEPICTION BASED ON INFORMATION GATHERED FROM VARIOUS SOURCES OF RECORD AND AVAILABLE MONUMENTATION FOUND DURING THE FIELD SURVEY. NO EASEMENTS WERE RESEARCHED OR PLOTTED. PROPERTY LINES AND LINES OF TITLE WERE NOT INVESTIGATED NOR SURVEYED. NO PROPERTY MONUMENTS WERE SET.

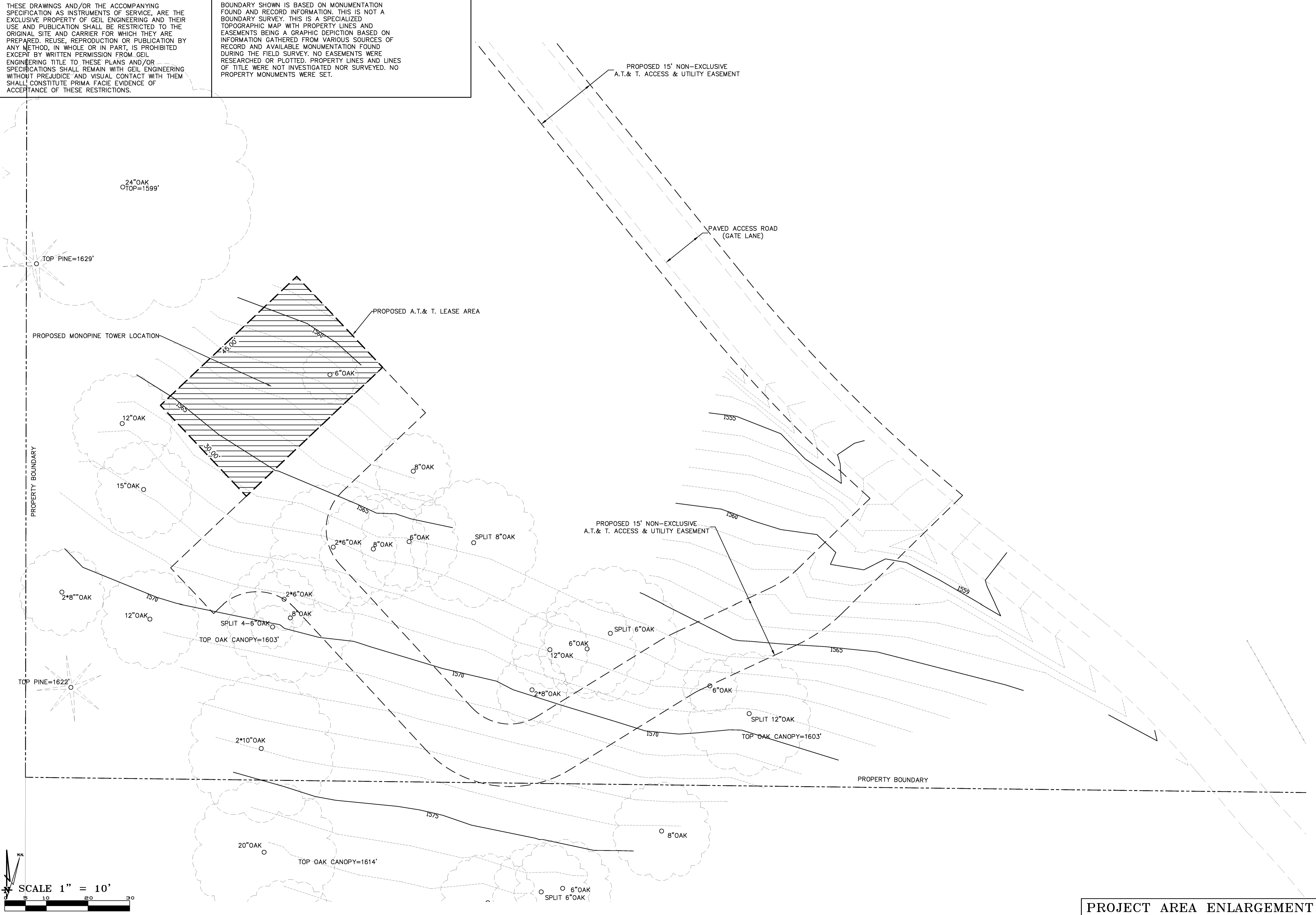

DEPT	APPROVED	DATE
ARC		
RE		
RF		
INT		
EE\IN		
OPS		
EE\OUT		

Surveyor  
**GEIL ENGINEERING**  
 ENGINEERING • SURVEYING • PLANNING  
 1226 HIGH STREET  
 AUBURN, CALIFORNIA 96905  
 Phone: (530) 885-1886  
 Fax: (530) 885-1806

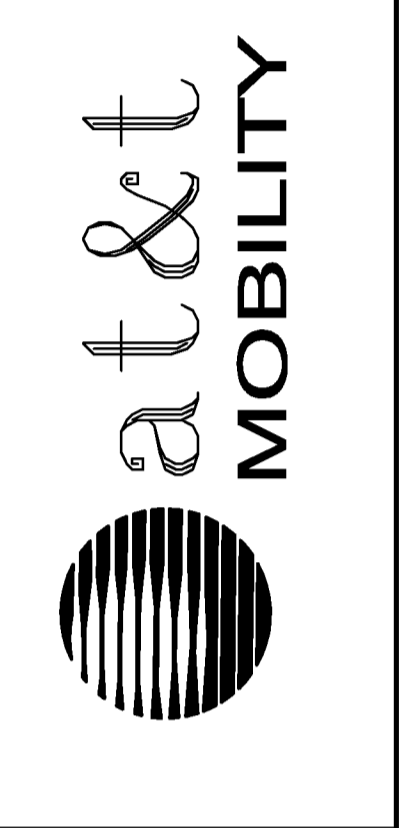

**CVL03629 ZEE ESTATES**  
 GATE LANE 1,000' SOUTH EAST OF THE INTERSECTION  
 OF GATE LANE AND SALMON FALLS ROAD  
 PILOT HILL, CA 95664  
 PLOT PLAN AND  
 SITE TOPOGRAPHY

Sheet

C-2

PROJECT AREA ENLARGEMENT

**GENERAL NOTES**

- THE CONTRACTOR SHALL HAVE A RESPONSIBLE PARTY, WHO SHALL HAVE THE AUTHORITY TO REPRESENT AND ACT FOR THE CONTRACTOR, ON THE JOB SITE DURING ALL WORKING HOURS.
- ALL WORK SHALL BE ACCOMPLISHED TO THE SATISFACTION OF THE WASHOE COUNTY AUTHORIZED REPRESENTATIVE.

DEFINITIONS:  
 (ESC) - EROSION AND SEDIMENT CONTROL  
 (NPDES) - NATIONAL POLLUTANT DISCHARGE ELIMINATION SYSTEM  
 (CWA) - CLEAN WATER ACT  
 (SWPPP) - STORM WATER POLLUTION PREVENTION PLAN  
 (BMP'S) - BEST MANAGEMENT PRACTICES

**THE CONTRACTOR SHALL:**

MAKE HIM/HERSELF AWARE OF THE REQUIREMENTS OF SAID GENERAL PERMIT AND THE PROVISIONS OF THE GRADING & EROSION CONTROL PLANS.

IMPLEMENT THE ESC FEATURES AND BEST MANAGEMENT PRACTICES (BMP'S) CONTAINED IN THE IMPROVEMENT PLANS, AND OTHERWISE DILIGENTLY PURSUE COMPLIANCE WITH THE LOCAL REQUIREMENTS.

ASSIST THE OWNER, ENGINEER, AND PUBLIC WORKS DEPARTMENT STAFF IN THE ASSESSMENT OF THE FUNCTIONALITY OF AND MODIFICATIONS TO THE FEATURES AND PRACTICES IMPLEMENTED AND PROPOSED.

MEET WITH THE OWNER AND THE PUBLIC WORKS DEPARTMENT STAFF TO DETERMINE AND DISCUSS THE STATUS OF THE PROJECT, CONSTRUCTION SCHEDULE, AND ANY MODIFICATIONS AND/OR ADDITIONS TO THE ESC FEATURES IN ORDER TO DILIGENTLY PURSUE COMPLIANCE.

DOCUMENT ANY MAINTENANCE, REPLACEMENT, INSPECTION, MODIFICATIONS OR ADDITIONS TO THE PROJECT ESC FEATURES, AND NOTIFY THE ENGINEER, OWNER AND PUBLIC WORKS DEPARTMENT STAFF OF ANY SUBSTANTIAL MODIFICATIONS OR ADDITIONS TO THE ESC PRACTICES AND FEATURES. ALL DISTURBED AREAS SHALL BE PROTECTED WITH APPROVED MATERIALS WITHIN 15 DAYS OF COMPLETION OF THE FINISHED GRADES.

MAINTAIN AN INVENTORY OF ESC MATERIALS (STRAW BALES, 1.5" - 3" CLEAN CRUSHED ROCK, FIBER ROLLS, SILT FENCE, ROCK BAGS, ETC.) ON SITE FOR EMERGENCY USE AS DIRECTED BY THE ENGINEER, OWNER, OR THE PUBLIC WORKS DEPARTMENT STAFF.

**OTHER RESPONSIBILITIES OF APPLICANT:**

- PROTECTION OF UTILITIES. THE APPLICANT SHALL BE RESPONSIBLE FOR THE PREVENTION OF DAMAGE TO ANY PUBLIC UTILITIES OR SERVICES.
- PROTECTION OF ADJACENT PROPERTY. THE APPLICANT SHALL BE RESPONSIBLE
- FOR THE PREVENTION OF DAMAGE TO ADJACENT PROPERTY. NO PERSON(S) SHALL EXCAVATE ON LAND THAT IS SO CLOSE TO THE PROPERTY LINE AS TO ENDANGER ANY ADJOINING PUBLIC STREET, SIDEWALK, ALLEY, STRUCTURE OR OTHER PUBLIC OR PRIVATE PROPERTY OR EASEMENT WITHOUT SUPPORTING AND PROTECTING SUCH PROPERTY FROM ANY DAMAGE WHICH MIGHT OTHERWISE RESULT.
- ADVANCE NOTICE. THE APPLICANT SHALL NOTIFY THE COUNTY AT LEAST FORTY-EIGHT HOURS PRIOR TO THE START OF WORK.
- EROSION AND SEDIMENT CONTROL. IT SHALL BE THE SOLE RESPONSIBILITY OF THE APPLICANT TO PREVENT DISCHARGE OF SEDIMENT FROM THE SITE, IN QUANTITIES GREATER THAN BEFORE THE GRADING OCCURRED, TO ANY WATERCOURSE, DRAINAGE SYSTEM, OR ADJACENT PROPERTY.
- COMPLIANCE WITH STORMWATER RUNOFF POLLUTION CONTROL CODE. AT ALL TIMES DURING THE PRECONSTRUCTION AND CONSTRUCTION OF ANY PROJECT FOR WHICH GRADING APPROVAL IS ISSUED UNTIL ALL FINAL IMPROVEMENTS AND PERMANENT STRUCTURES ARE COMPLETE, THE APPLICANT SHALL FULLY COMPLY WITH ALL APPLICABLE REQUIREMENTS OF THE STORMWATER RUNOFF POLLUTION CONTROL CODE.
  - 1. WET SEASON: ENTIRE PERIOD BETWEEN OCTOBER 1 THROUGH APRIL 30. CONTRACTOR SHALL ALSO IMPLEMENT WET SEASON MEASURES IF WET WEATHER IS EXPECTED DURING THE DRY SEASON.
  - 2. PHASES OF GRADING
    - . INITIAL (STAGE 1): WHEN CLEARING AND GRUBBING ACTIVITIES OCCUR.
    - . ROUGH (STAGE 2): WHEN CUT AND FILL ACTIVITIES OCCUR AND THE SITE IMPROVEMENTS ARE CONSTRUCTED, INCLUDING UNDERGROUND PIPING, STREETS, SIDEWALKS, AND OTHER IMPROVEMENTS.
    - . FINAL (STAGE 3): WHEN FINAL ELEVATIONS ARE SET, AND SITE IMPROVEMENTS ARE COMPLETED AND READY FOR COUNTY ACCEPTANCE.

**EROSION CONTROL NOTES**

- ALL EROSION AND SEDIMENT CONTROL MEASURES SHALL BE CONSTRUCTED AND MAINTAINED IN ACCORDANCE WITH THE COUNTY IMPROVEMENT STANDARDS, CURRENT EDITION, AND THE COUNTY EROSION AND SEDIMENT CONTROL GUIDELINES.
- EROSION CONTROL BEST MANAGEMENT PRACTICES (BMP'S) SHALL BE INSTALLED AND MAINTAINED DURING THE WET SEASON (OCTOBER THROUGH APRIL 30). SEDIMENT CONTROL BMP'S SHALL BE INSTALLED AND MAINTAINED ALL YEAR.
- ALL DRAINAGE INLETS IMMEDIATELY DOWNSTREAM OF THE WORK AREAS AND WITHIN THE WORK AREAS SHALL BE PROTECTED WITH SEDIMENT CONTROL AND INLET FILTER BAGS, YEAR ROUND. INLET FILTER BAGS SHALL BE REMOVED FROM THE DRAINAGE INLETS UPON ACCEPTANCE OF THE PUBLIC IMPROVEMENTS BY THE COUNTY.
- ALL AREAS DISTURBED DURING CONSTRUCTION, BY GRADING, TRENCHING, OR OTHER ACTIVITIES, SHALL BE PROTECTED FROM EROSION DURING THE WET SEASON (OCTOBER 1 THROUGH APRIL 30). HYDROSEED, IF UTILIZED, MUST BE PLACED BY SEPTEMBER 15. HYDROSEED PLACED DURING THE WET SEASON SHALL USE A SECONDARY EROSION PROTECTION METHOD.
- SENSITIVE AREAS AND AREAS WHERE EXISTING VEGETATION IS BEING PRESERVED SHALL BE PROTECTED WITH CONSTRUCTION FENCING. SEDIMENT CONTROL BMP'S SHALL BE INSTALLED WHERE ACTIVE CONSTRUCTION AREAS DRAIN INTO SENSITIVE OR PRESERVED VEGETATION AREAS.
- SEDIMENT CONTROL BMP'S SHALL BE PLACED ALONG THE PROJECT PERIMETER WHERE DRAINAGE LEAVES THE PROJECT. SEDIMENT CONTROL BMP'S SHALL BE MAINTAINED YEAR ROUND UNTIL THE CONSTRUCTION IS COMPLETE OR THE DRAINAGE PATTERN HAS BEEN CHANGED AND NO LONGER LEAVES THE SITE.
- THE FOLLOWING AREAS ARE TO RECEIVE HYDROSEEDING OR OTHER EROSION CONTROL: ALL SLOPES GREATER THAN 10:1.
- FOR DEWATERING OPERATIONS, SEDIMENT-LADEN STORM WATER SHALL BE EITHER PUMPED (NOTE 10) OR ROUTED (TEMPORARY DIVERSION SWALE) TO SEDIMENT TRAP(S) TO ALLOW SEDIMENT TO SETTLE OUT BEFORE DISCHARGE OFF-SITE. ONCE SEDIMENT HAS SETTLED OUT, WATER WILL BE DISCHARGED THROUGH SWALE LINED WITH IMPERVIOUS PLASTIC LINER.
- USE OF FIBER ROLLS SHALL BE AUGMENTED DURING WET SEASON WITH DEWATERING BMP'S IN THE EVENT THAT FIBER ROLLS DO NOT EFFECTIVELY RETAIN STORM WATER ON SITE. DEWATERING MAY INCLUDE PUMPS OR BERMS TO ROUTE WATER TO THE SEDIMENT TRAP. IF PUMPS ARE USED, THEN FILTER BAGS SHALL BE USED AT DISCHARGE HOSE ENDS. DEWATERING MATERIAL SHALL NOT BE DISCHARGED DIRECTLY TO THE STORM DRAIN SYSTEM.

**BMP INSTALLATION SCHEDULE**

BEST MANAGEMENT PRACTICE	LOCATION	IMPLEMENTATION SCHEDULE	MAINTENANCE SCHEDULE
A. PRESERVING EXISTING VEGETATION	AROUND PERIMETER OF PROJECT SITE	CONTINUOUS, UNTIL CONSTRUCTION IS COMPLETED	EDUCATE EMPLOYEES AND SUBCONTRACTORS REGARDING IMPORTANCE AT MAINTAINING EXISTING VEGETATION TO PREVENT EROSION AND FILER AND SEDIMENT IN RUNOFF FROM DISTURBED AREAS ON THE CONSTRUCTION SITE. INSPECT SITE PERIMETER MONTHLY TO VERIFY THE OUTSIDE VEGETATION IS NOT DISTURBED.
B. PROTECT GRADED AREAS AND SLOPES FROM WASHOUT & EROSION	THROUGHOUT PROJECT SITE	DURING WET SEASON	INSPECT GRADED AREAS AND SLOPES ON AT LEAST A MONTHLY BASIS TO CHECK FOR EROSION. REGRADE TRIBUTARY AREAS OR INSTALL FILTER BARRIER OR SAND BAG DIKES AS NECESSARY TO PREVENT EROSION.
C. GRAVEL FILTER	ALONG FLOW LINES OF UNPAVED ROADWAYS WITHIN SITE	IN PLACE DURING WET SEASON UNTIL ROADWAYS ARE PAVED	INSPECT DAILY AND AFTER EACH STORM. REMOVE ONSITE SEDIMENT DEPOSITED BEHIND BERM OR BARRIER TO MAINTAIN EFFECTIVENESS.
D. INLET FILTER BAG	INLETS TO THE STORM DRAINAGE SYSTEM	CONTINUOUS UNTIL LANDSCAPING IS IN PLACE	INSPECT WEEKLY AND AFTER EACH STORM. REMOVE SEDIMENT AND DEBRIS BEFORE ACCUMULATIONS HAVE REACHED ONE THIRD THE DEPTH OF THE BAG. REPAIR OR REPLACE INLET FILTER BAG AS SOON AS DAMAGE OCCURS.
E. FIBER ROLL	SEE PLAN SHEET C-4	CONTINUOUS	INSPECT WEEKLY AND AFTER EACH STORM. REMOVE SEDIMENT DEPOSITED BEHIND FIBER ROLL WHENEVER NECESSARY TO MAINTAIN EFFECTIVENESS.
F. HYDROSEEDING	3:1 SLOPES	IN PLACE DURING BY SEPT. 15	INSPECT SLOPES ON AT LEAST A MONTHLY BASIS TO CHECK FOR EROSION. IF EROSION IS NOTED, SPREAD STRAW MULCH OVER AFFECTED AREAS.
G. STABILIZED CONSTRUCTION ENTRANCE	ENTRANCES TO SITE FROM PUBLIC ROADWAYS	CONTINUOUS, UNTIL ENTRANCES AND ONSITE ROADWAYS ARE PAVED	INSPECT ON A MONTHLY BASIS AND AFTER EACH RAINFALL. ADD AGGREGATE BASE MATERIAL WHENEVER NECESSARY TO PREVENT SEDIMENT FROM BEING TRACKED INTO PUBLIC STREET.
H. WIND EROSION CONTROL PRACTICES	WHEREVER NECESSARY THROUGHOUT PROJECT SITE	CONTINUOUS UNTIL GRADING IS COMPLETED AND SOILS HAVE STABILIZED	INSPECT SITE DURING WINDY CONDITIONS TO IDENTIFY AREAS WHERE WIND EROSION IS OCCURRING AND ABATE EROSION AS NECESSARY
I. GOOD HOUSEKEEPING MEASURES	THROUGHOUT PROJECT SITE	CONTINUOUS UNTIL CONSTRUCTION IS COMPLETED	INSPECT SITE ON AT LEAST A MONTHLY BASIS TO VERIFY THAT GOOD HOUSEKEEPING PRACTICES ARE BEING IMPLEMENTED.
J. PROPER CONSTRUCTION MATERIAL STORAGE	DESIGNATED AREA	CONTINUOUS UNTIL CONSTRUCTION IS COMPLETED	INSPECT SITE ON AT LEAST A WEEKLY BASIS TO VERIFY THAT CONSTRUCTION MATERIALS ARE STORED IN A MANNER, WHICH COULD NOT CAUSE STORM WATER POLLUTION.
K. PROPER CONSTRUCTION WASTE STORAGE AND DISPOSAL INCLUDING 1) CONCRETE SPILL CLEANUP INCLUDING 1) PAINT & PAINTING SUPPLIES 2) VEHICLE FUELING MAINTENANCE & CLEANING	DESIGNATED COLLECTION AREA AND CONTAINERS  MATERIAL HANDLING AREA  DESIGNATED AREA WITH SECONDARY CONTAINMENT	CONTINUOUS UNTIL CONSTRUCTION IS COMPLETED  IMMEDIATELY AT TIME OF SPILL  CONTINUOUS	INSPECT MATERIAL HANDING AREAS ON AT LEAST A MONTHLY BASIS TO VERIFY PROPER SPILL CLEANUP.  KEEP AMPLE SUPPLIES OF SPILL CLEANUP MATERIALS ON SITE & INSPECT ON REGULAR SCHEDULE.
L. STREET AND STORM DRAINAGE FACILITY MAINTENANCE DEFINITIONS	STREETS AND STORM DRAINAGE FACILITIES	CONTINUOUS UNTIL CONSTRUCTION IS COMPLETED	MAINTAIN STORM DRAINAGE FACILITIES AND PAVED STREETS CLEAR OF SEDIMENT AND DEBRIS.

1. WET SEASON: ENTIRE PERIOD BETWEEN OCTOBER 1 THROUGH APRIL 30. CONTRACTOR SHALL ALSO IMPLEMENT WET SEASON MEASURES IF WET WEATHER IS EXPECTED DURING THE DRY SEASON.  
 2. PHASES OF GRADING  
 . INITIAL (STAGE 1): WHEN CLEARING AND GRUBBING ACTIVITIES OCCUR.  
 . ROUGH (STAGE 2): WHEN CUT AND FILL ACTIVITIES OCCUR AND THE SITE IMPROVEMENTS ARE CONSTRUCTED, INCLUDING UNDERGROUND PIPING, STREETS, SIDEWALKS, AND OTHER IMPROVEMENTS.  
 . FINAL (STAGE 3): WHEN FINAL ELEVATIONS ARE SET, AND SITE IMPROVEMENTS ARE COMPLETED AND READY FOR COUNTY ACCEPTANCE.



**ER-1** PORTABLE CONCRETE WASHOUT CONTAINER  
NO SCALE

**INSPECTION & MAINTENANCE OF FIBER ROLLS:**

- REPAIR OR REPLACE SPLIT, TORN, UNRAVELING OR SLUMPING FIBER ROLLS.
- INSPECT FIBER ROLLS WHEN RAIN IS FORECAST, FOLLOWING RAIN EVENTS, AT LEAST DAILY DURING PROLONGED RAINFALL, AND AT TWO-WEEK INTERVALS DURING THE NON-RAINY SEASON.
- SEDIMENT SHOULD BE REMOVED WHEN SEDIMENT ACCUMULATION REACHES ONE-HALF THE DESIGNATED SEDIMENT STORAGE DEPTH. USUALLY ONE-HALF THE DISTANCE BETWEEN THE TOP OF THE FIBER ROLL AND THE ADJACENT GROUND SURFACE. SEDIMENT REMOVED DURING MAINTENANCE MAY BE INCORPORATED INTO THE EARTHWORK ON THE SITE OR DEPOSITED AT AN APPROPRIATE LOCATION.

**NOTES:**

- FILTER BARRIER SHALL BE CONSTRUCTED LONG ENOUGH TO EXTEND ACROSS THE EXPECTED FLOW PATH AND AS APPROVED BY THE LANDSCAPE INSPECTOR.
- FIBER ROLL (8 TO 12" DIAMETER) SHALL BE PLACED INTO THE KEY TRENCH AND STAKES ON BOTH SIDES OF THE ROLL WITHIN 6 FEET OF EACH END AND THEN EVERY 3' TO 4' WITH 1" X 2" X 23" STAKES. STAKES ARE TYPICALLY DRIVEN IN ON ALTERNATING SIDES OF THE ROLL. ADJACENT ROLLS SHALL TIGHTLY ABUT.
- CLEAR SUBGRADE SO THAT REMOVAL OF ALL LOCAL DEVIATIONS AND TO REMOVE LARGE STONES OR DEBRIS THAT WILL INHIBIT INTIMATE CONTACT OF THE FIBER ROLL WITH THE SUBGRADE.
- PRIOR TO ROLL INSTALLATION, CONTOUR A CONCAVE TRENCH (2 TO 4 INCHES) DEEP ALONG THE PROPOSED INSTALLATION ROUTE. FIBER ROLL SHALL BE INSTALLED ALONG THE SIDE OF WALKS AND AROUND THE CATCH BASING. THE BOTTOM EDGE OF THE FIBER ROLL SHALL EXTEND TO AND ACROSS THE BOTTOM OF THE TRENCH. THE TRENCH SHALL BE BACKFILLED TO 4 INCHES ABOVE GROUND AND COMPACTED TO BURY AND SECURE THE BOTTOM OF THE FIBER ROLL.
- CONTRACTOR SHALL MAKE INSPECTIONS WEEKLY DURING THE WET SEASON. MONTHLY DURING THE DRY SEASON AND IMMEDIATELY AFTER EACH RAINFALL TO DETERMINE IF REPAIRS AND SEDIMENT REMOVAL IS REQUIRED. SEDIMENT SHALL BE REMOVED BEFORE IT HAS REACHED ONE THIRD THE HEIGHT OF THE FILTER FABRIC.

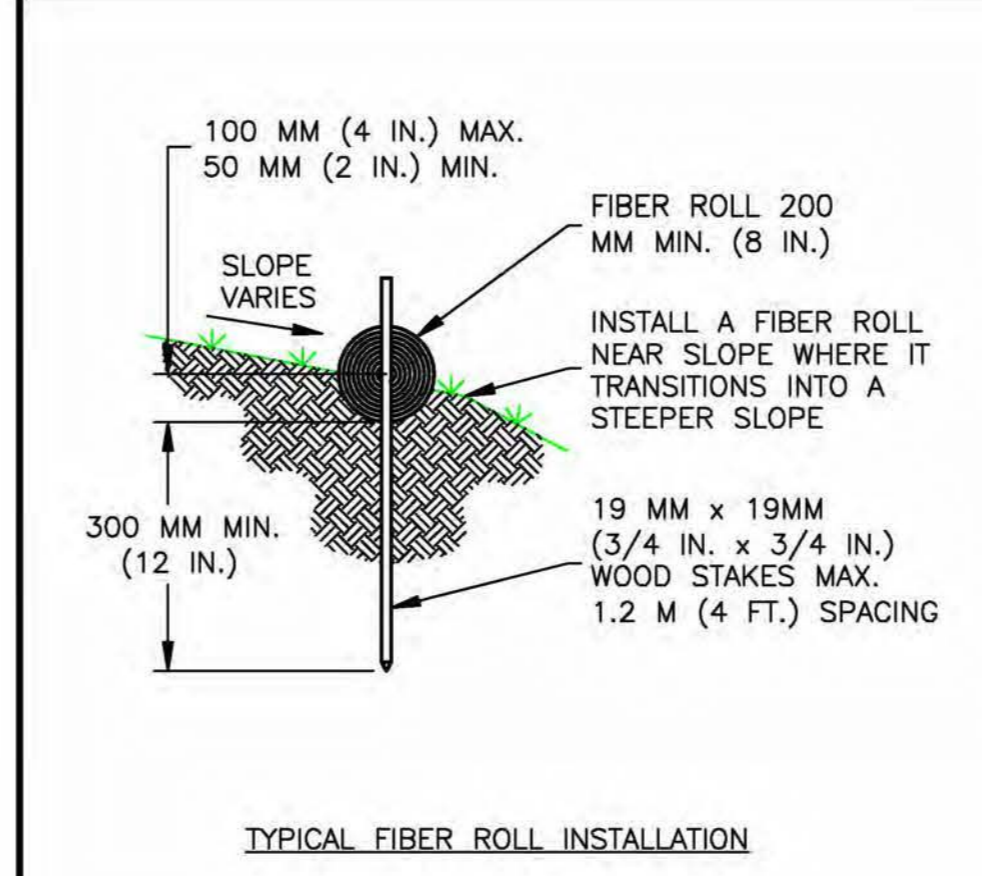

**ER-2** TYPICAL FIBER ROLL INSTALLATION  
FIBER ROLLS  
NO SCALE

**REVEGETATION STANDARDS**

- PERMANENT REVEGETATION OR LANDSCAPING, IF REQUIRED, IS TO BE COMMENCED ON THE CONSTRUCTION SITE AS SOON AS PRACTICAL AND IN NO CASE EXCEEDING TWELVE MONTHS AFTER ACHIEVING FINAL GRADES AND UTILITY PLACEMENTS. WHENEVER PRACTICAL, LAND IS TO BE DEVELOPED IN INCREMENTS OF WORKABLE SIZE WHICH CAN BE COMPLETED DURING A SINGLE CONSTRUCTION SEASON; EROSION CONTROL MEASURES ARE TO BE COORDINATED WITH THE SEQUENCE OF GRADING OR IMPROVEMENTS.
- ALL SURFACES DISTURBED BY VEGETATION REMOVAL, GRADING, HAUL ROADS, OR OTHER ACTIVITY OF CONSTRUCTION WHICH ALTERS THE NATURAL VEGETATIVE COVER ARE TO BE PREPARED FOR EXPEDIENT REVEGETATION OR OTHERWISE MAINTAINED TO CONTROL EROSION UNLESS COVERED WITH IMPERVIOUS OR OTHER IMPROVED SURFACES PURSUANT TO APPROVED PLANS WITHIN FOURTEEN DAYS FOLLOWING THE COMPLETION OF GRADING, OR REMOVAL OF VEGETATION IF NO GRADING WAS INVOLVED.
- TOPSOIL REMOVED FROM THE SURFACE IN PREPARATION FOR GRADING SHALL BE RESTORED TO EXPOSE CUT AND FILL EMBANKMENTS OR BUILDING PADS SO AS TO PROVIDE A SUITABLE BASE FOR SEEDING AND PLANTING.
- ACCEPTABLE METHODS OF REVEGETATION INCLUDE STRAW-MULCHING, HYDRO-MULCHING OR PLANTING OF MIXTURE SPECIFIED IN THE IMPROVEMENT STANDARDS. OTHER METHODS OF REVEGETATION MAY BE APPROVED BY THE COUNTY ENGINEER WHERE EQUIVALENT PROTECTION IS PROVIDED.
- ALL REVEGETATION AND LANDSCAPING ARE TO BE CONDUCTED WITHIN SUITABLE GROWING PERIODS. NATIVE PLANT MATERIALS ARE SPECIFICALLY ENCOURAGED IN ORDER TO REDUCE IRRIGATION DEMANDS.
- TEMPORARY SEDIMENTATION CONTROL FACILITIES ARE TO BE INSTALLED IN CONJUNCTION WITH INITIAL GRADING OPERATIONS AND MAINTAINED THROUGHOUT THE CONSTRUCTION PERIOD TO REMOVE SEDIMENTS FROM RUNOFF WATERS DURING DEVELOPMENT.
- PERMANENT SEDIMENT CATCHMENT BASINS OR OTHER TYPES OF SEDIMENT RETENTION FACILITIES ARE REQUIRED WHEREVER NECESSARY TO PREVENT DISCHARGE OF SEDIMENT INTO WATERS OF THE STATE. SEDIMENT RETENTION FACILITIES SHALL BE INSPECTED AND CLEANED ACCORDING TO A REGULAR MAINTENANCE SCHEDULE.
- THE PLANTING OR SEEDING OF VEGETATIVE PROTECTION MUST BE EFFECTIVE. IF THE VEGETATION DOES NOT GROW AND OFFER PROPER PROTECTION, IT MUST BE REPLANTED OR RESEEDED.
- THE MAINTENANCE OF VEGETATIVE PROTECTION ON GRADED SLOPES SHALL BE THE RESPONSIBILITY OF THE PERMITTEE AND SHALL BE GUARANTEED UNTIL THE VEGETATION IS WELL ESTABLISHED OR IS OFFICIALLY ASSUMED BY ANOTHER PARTY.

**DUST MITIGATION PLAN**

- SECTION 1: FUGITIVE DUST PREVENTION AND CONTROL**
- LAND CLEARING/EARTH MOVING:**  
 WATER SHALL BE APPLIED BY MEANS OF TRUCK(S), HOSES AND/OR SPRINKLERS PRIOR TO ANY LAND CLEARING OR EARTH MOVEMENT TO MINIMIZE DUST EMISSIONS. HAUL VEHICLES TRANSPORTING SOIL INTO OR OUT OF THE PROPERTY SHALL BE COVERED.
- VISIBLY DRY DISTURBED SOIL SURFACE AREAS:**  
 ALL VISIBLY DRY DISTURBED SOIL SURFACE AREAS OF OPERATION SHALL BE WATERED TO MINIMIZE DUST EMISSIONS.
- PAVED ROAD TRACK-OUT:**  
 PAVED ROADS SHALL BE CLEANED IF THE AMOUNT OF DIRT TRACKED-OUT OF THE OPERATION AREA HAS THE POTENTIAL TO CAUSE DUST EMISSIONS.
- VISIBLY DRY DISTURBED UNPAVED DRIVEWAYS:**  
 ALL VISIBLY DRY DISTURBED UNPAVED DRIVEWAY SURFACE AREAS OF OPERATION SHALL BE WATERED TO MINIMIZE DUST EMISSIONS. UNPAVED DRIVEWAYS MAY BE GRAVELED TO REDUCE DUST EMISSIONS.
- VEHICLES ENTERING / EXITING CONSTRUCTION AREA:**  
 VEHICLES ENTERING OR EXITING CONSTRUCTION AREA SHALL TRAVEL AT A SPEED WHICH MINIMIZES DUST EMISSIONS.
- EMPLOYEE VEHICLES:**  
 CONSTRUCTION WORKERS PARK IN DESIGNATED PARKING AREA(S) TO HELP REDUCE DUST EMISSIONS.
- SOIL PILES:**  
 SOIL PILE SURFACES SHALL BE MOISTENED IF DUST IS BEING EMITTED FROM THE PILE(S). ADEQUATELY SECURED TARPS, PLASTIC OR OTHER MATERIAL MAY BE REQUIRED TO FURTHER REDUCE DUST EMISSIONS.

PROPRIETARY INFORMATION  
 THE INFORMATION CONTAINED IN THIS SET OF DRAWINGS IS PROPRIETARY BY NATURE. ANY USE OR DISCLOSURE OTHER THAN THAT WHICH RELATES TO PEEK SITE-COM IS STRICTLY PROHIBITED

CLIENT: \_\_\_\_\_

5001 EXECUTIVE PKWY  
 SAN RAMON, CA 94583

PROJECT INFORMATION:

**ZEE ESTATES**

GATE LANE 1,000' SOUTH EAST OF THE INTERSECTION OF GATE LANE AND SALMON FALLS ROAD  
 PILOT HILL, CA 95664

REV:	DATE:	DESCRIPTION:	BY:
1	6-29-17	90% ZONING DOC'S	RB
1	8-3-17	90% ZONING DOC'S	ALP
2	8-9-17	100% ZONING DOC'S	ALP

COORDINATING ENGINEER:

**Peek Site-Com**

12852 Earhart Ave. Suite 101  
 Auburn, California 95602  
 Phone (530) 885-6160

E-Mail [info@peeksitecom.com](mailto:info@peeksitecom.com)

SEAL:

SITE #: \_\_\_\_\_ CHK.: \_\_\_\_\_ DRAWN BY: \_\_\_\_\_

CVL03629 ... RB

**EROSION CONTROL NOTES**

SHEET NUMBER: **C-3** REVISION: **0**

**GRADING STANDARDS**

1. GENERAL. UNLESS OTHERWISE RECOMMENDED IN THE APPROVED SOILS ENGINEERING OR ENGINEERING GEOLOGY REPORT, GRADING ACTIVITIES SHALL CONFORM TO THE PROVISIONS OF THIS SECTION.
  - A. CUT SLOPE. THE SLOPE OF CUT SURFACES SHALL BE NO STEEPER THAN IS SAFE FOR THE INTENDED USE AND SHALL BE NO STEEPER THAN 1 UNIT VERTICAL IN 2 UNITS HORIZONTAL (50% SLOPE) UNLESS THE PERMITTEE FURNISHES A SOILS ENGINEERING OR AN ENGINEERING GEOLOGY REPORT, OR BOTH, STATING THAT THE SITE HAS BEEN INVESTIGATED AND GIVING AN OPINION THAT A CUT AT A STEEPER SLOPE WILL BE STABLE AND NOT CREATE A HAZARD TO PROPERTY OR THE ENVIRONMENT.
  - B. FILL SLOPE AND PREPARATION
    - (1) PREPARATION OF GROUND. THE GROUND SURFACE SHALL BE PREPARED TO RECEIVE FILL BY REMOVING VEGETATION, NON-COMPLYING FILL, TOPSOIL AND OTHER UNSUITABLE MATERIALS SCARIFYING TO PROVIDE A BOND WITH THE NEW FILL.
    - (2) FILL MATERIAL. AMOUNT OF ORGANIC MATERIAL DETRIMENTAL TO STRUCTURAL INTEGRITY SHALL NOT BE PERMITTED IN FILLS. EXCEPT AS PERMITTED BY THE BUILDING OFFICIAL, NO ROCK OR SIMILAR IRREDUCIBLE MATERIAL WITH A MAXIMUM DIMENSION GREATER THAN 12 INCHES (0.31 M) SHALL BE BURIED OR PLACED IN FILLS.
    - (3) EXCEPTION. THE BUILDING OFFICIAL MAY PERMIT PLACEMENT OF LARGER ROCK WHEN THE SOILS ENGINEER PROPERLY DEVISES A METHOD OF PLACEMENT, AND CONTINUOUSLY INSPECTS ITS PLACEMENT AND APPROVES THE FILL STABILITY. THE FOLLOWING CONDITIONS SHALL ALSO APPLY:
      - (a) PRIOR TO ISSUANCE OF THE GRADING PERMIT, POTENTIAL ROCK DISPOSAL AREAS SHALL BE SHOWN ON THE GRADING PLAN.
      - (b) ROCK SIZES GREATER THAN 12 INCHES (0.31 M) IN MAXIMUM DIMENSION SHALL BE 10 FEET (3.05 M) OR MORE BELOW GRADE, MEASURED VERTICALLY.
      - (c) ROCKS SHALL BE PLACED SO AS TO ASSURE FILLING OF ALL VOIDS WITH WELL-GRADED SOIL.
    - (4) COMPACTION. ALL FILLS SHALL BE COMPACTED TO A MINIMUM OF 90 PERCENT OF MAXIMUM DRY DENSITY WITH SUFFICIENT TESTING FOR DOCUMENTATION OF COMPLIANCE WITH THIS STANDARD.
    - (5) SLOPE. THE SLOPE OF FILL SURFACES SHALL BE NO STEEPER THAN IS SAFE FOR THE INTENDED USE. FILL SLOPES SHALL BE NO STEEPER THAN 1 UNIT VERTICAL IN 2 UNITS HORIZONTAL (50% SLOPE).
2. SETBACKS
  - a. GENERAL. CUT AND FILL SLOPES SHALL BE SET BACK FROM SITE BOUNDARIES IN ACCORDANCE WITH THIS SECTION. SETBACK DIMENSIONS SHALL BE HORIZONTAL DISTANCES MEASURED PERPENDICULAR TO THE SITE BOUNDARY.
  - c. TOP OF CUT SLOPE. THE TOP OF CUT SLOPES SHALL NOT BE MADE NEARER TO A SITE BOUNDARY LINE THAN A MINIMUM OF 2 FEET. THE SETBACK MAY NEED TO BE INCREASED FOR ANY REQUIRED INTERCEPTOR DRAINS.
  - d. TOE OF FILL SLOPE. THE TOE OF FILL SLOPE SHALL BE MADE NOT NEARER TO THE SITE BOUNDARY LINE THAN MINIMUM OF 2 FEET. WHERE A FILL SLOPE IS TO BE LOCATED NEAR THE SITE BOUNDARY AND THE ADJACENT OFFSITE PROPERTY IS DEVELOPED, SPECIAL PRECAUTIONS SHALL BE INCORPORATED IN THE WORK AS THE BUILDING OFFICIAL DEEMS NECESSARY TO PROTECT THE ADJOINING PROPERTY FROM DAMAGE AS A RESULT OF SUCH GRADING. THESE PRECAUTIONS MAY INCLUDE BUT ARE NOT LIMITED TO:
    - (1) ADDITIONAL SETBACKS.
    - (2) PROVISION FOR RETAINING, OR SLOUGH WALLS.
    - (3) MECHANICAL OR CHEMICAL TREATMENT OF THE FILL SLOPE SURFACE TO MINIMIZE EROSION.
    - (4) PROVISIONS FOR THE CONTROL OF SURFACE WATERS.
  - e. MODIFICATION OF SETBACKS. THE BUILDING OFFICIAL MAY APPROVE ALTERNATE SETBACKS. THE BUILDING OFFICIAL MAY REQUIRE AN INVESTIGATION AND RECOMMENDATION BY A QUALIFIED ENGINEER OR ENGINEERING GEOLOGIST TO DEMONSTRATE THAT THE INTENT OF THIS SECTION HAS BEEN SATISFIED.
3. MAINTENANCE REQUIRED. THE PROPERTY OWNER SHALL BE RESPONSIBLE FOR ADEQUATELY MAINTAINING ALL DRAINAGE FACILITIES INSTALLED PURSUANT TO THIS SECTION.
4. GRADING INSPECTION
  - A. GENERAL. GRADING OPERATIONS FOR WHICH A PERMIT IS REQUIRED SHALL BE SUBJECT TO INSPECTION BY THE BUILDING OFFICIAL.
  - B. PERMITTEE. THE PERMITTEE SHALL BE RESPONSIBLE FOR THE WORK TO BE PERFORMED IN ACCORDANCE WITH THE APPROVED PLANS AND SPECIFICATIONS AND IN CONFORMANCE WITH THE PROVISIONS OF THIS CODE, AND THE PERMITTEE SHALL ENGAGE CONSULTANTS, IF REQUIRED, TO PROVIDE PROFESSIONAL INSPECTIONS ON A TIMELY BASIS. THE PERMITTEE SHALL ACT AS A COORDINATOR BETWEEN THE CONSULTANTS, THE CONTRACTOR AND THE BUILDING OFFICIAL. IN THE EVENT OF CHANGED CONDITIONS, THE PERMITTEE SHALL BE RESPONSIBLE FOR INFORMING THE BUILDING OFFICIAL OF SUCH CHANGE AND SHALL PROVIDE REVISED PLANS FOR APPROVAL.
  - C. BUILDING OFFICIAL. THE BUILDING OFFICIAL SHALL INSPECT THE PROJECT AT THE VARIOUS STAGES OF WORK REQUIRING APPROVAL TO DETERMINE THAT ADEQUATE CONTROL IS BEING EXERCISED BY THE PROFESSIONAL CONSULTANTS.
  - D. NOTIFICATION OF NONCOMPLIANCE. IF, IN THE COURSE OF FULFILLING THEIR RESPECTIVE DUTIES UNDER THIS CHAPTER, THE CIVIL ENGINEER, THE SOILS ENGINEER OR THE ENGINEERING GEOLOGIST FINDS THAT THE WORK IS NOT BEING DONE IN CONFORMANCE WITH THIS CHAPTER OR THE APPROVED GRADING PLANS, THE DISCREPANCIES SHALL BE REPORTED IMMEDIATELY IN WRITING TO THE PERMITTEE AND TO THE BUILDING OFFICIAL.
  - E. TRANSFER OF RESPONSIBILITY. IF THE CIVIL ENGINEER, THE SOILS ENGINEER, OR THE ENGINEERING GEOLOGIST OF RECORD IS CHANGED DURING GRADING, THE WORK SHALL BE STOPPED UNTIL THE REPLACEMENT HAS AGREED IN WRITING TO ACCEPT THEIR RESPONSIBILITY WITHIN THE AREA OF TECHNICAL COMPETENCE FOR APPROVAL UPON COMPLETION OF THE WORK. IT SHALL BE THE DUTY OF THE PERMITTEE TO NOTIFY THE BUILDING OFFICIAL IN WRITING OF SUCH CHANGE PRIOR TO THE RE-COMMENCEMENT OF SUCH GRADING.
5. EROSION AND SEDIMENTATION CONTROL
  - A. ADMINISTRATION
    - (1) THE EROSION AND SEDIMENT CONTROL PROVISIONS OF THIS SECTION SHALL BE APPLICABLE TO ALL FACILITIES AND ACTIVITIES UNDER THE SUPERVISION OF THE DIRECTOR OF THE DEPARTMENT OF PUBLIC WORKS.
    - (2) THE ADMINISTRATION OF THIS SECTION, AS IT AFFECTS COUNTY FACILITIES AND ACTIVITIES, IS THE RESPONSIBILITY OF THE DIRECTOR OF THE DEPARTMENT OF PUBLIC WORKS.
    - (3) THE ADMINISTRATION OF THIS SECTION AS IT AFFECTS OTHER BUILDING, GRADING, AND RELATED ACTIVITIES IS THE RESPONSIBILITY OF THE CHIEF BUILDING OFFICIAL.
    - (4) ANY SOILS OR GEOLOGIC REPORTS PREPARED FOR ANY PROJECT WHERE A GRADING PERMIT IS SUBMITTED AS A PART OF A TENTATIVE SUBDIVISION MAP APPLICATION, OR RELATED ENVIRONMENTAL DOCUMENT, SHALL BE PLACED IN THE RECORDS OF THE CHIEF BUILDING OFFICIAL.
  - B. EROSION AND SEDIMENTATION CONTROL. THESE MINIMUM EROSION AND SEDIMENTATION CONTROL STANDARDS SHALL APPLY TO ALL PROJECTS REQUIRING BUILDING, GRADING, AND DEVELOPMENT PERMITS, AND COUNTY OF MENDOCINO PUBLIC WORKS ACTIVITIES, TO PREVENT SEDIMENTATION OR DAMAGE TO ONSITE AND OFFSITE PROPERTY. THESE STANDARDS SHALL BE INCORPORATED INTO THE PROJECT DESIGN AND SHALL BE ADHERED TO DURING PROJECT CONSTRUCTION:
    - (1) GENERAL GUIDELINES
      - (a) MINIMIZE SOIL EXPOSURE DURING THE RAINY SEASON BY PROPER TIMING OF GRADING AND CONSTRUCTION.
      - (b) RETAIN TREES AND NATURAL VEGETATION TO STABILIZE HILLSIDES, RETAIN MOISTURE, REDUCE EROSION, MINIMIZE SILTATION AND NUTRIENT RUNOFF AND PRESERVE SCENIC QUALITIES.
      - (c) VEGETATE AND MULCH DENUDED AREAS TO PROTECT THEM FROM WINTER RAINS.
      - (d) DIVERT RUNOFF AWAY FROM STEEP, DENUDED SLOPES OR OTHER CRITICAL AREAS WITH BARRIERS, BERMS, DITCHES OR OTHER FACILITIES.
      - (e) LIMIT CONSTRUCTION, CLEARING OF VEGETATION AND DISTURBANCE OF THE SOIL TO AREAS OF PROVEN STABILITY. MITIGATE GEOLOGIC HAZARDS AND ADVERSE SOIL CONDITIONS WHEN THEY ARE ENCOUNTERED.
      - (f) REDUCE SEDIMENT TRANSPORT OFF THE SITE TO THE MAXIMUM EXTENT FEASIBLE THROUGH THE USE OF BEST MANAGEMENT PRACTICES (BMPs).

- (g) PROPOSE A NEW OR MODIFIED EROSION AND SEDIMENT CONTROL TECHNIQUE IF THE TECHNIQUE IS PREFERRED AND MEETS THE INTENT OF THESE REGULATIONS. OBTAIN APPROVAL FROM THE COUNTY PRIOR TO IMPLEMENTATION.
  - (h) CONDUCT FREQUENT SITE INSPECTIONS TO ENSURE THAT CONTROL MEASURES ARE WORKING PROPERLY AND TO CORRECT PROBLEMS AS NEEDED.
  - (i) EMPLOY OTHER MEANS OF EROSION AND SEDIMENT CONTROL AS REQUIRED BY THE CHIEF BUILDING OFFICIAL OR DIRECTOR OF THE DEPARTMENT OF PUBLIC WORKS AS APPLICABLE.
- (2) SEDIMENT CONTROL**
- (a) USE SEDIMENT BASINS, SILT TRAPS, OR SIMILAR MEASURE TO RETAIN SEDIMENT TRANSPORTED BY RUNOFF WATER ONSITE.
  - (b) COLLECT AND DIRECT SURFACE RUNOFF AT NON-EROSIVE VELOCITIES TO THE COMMON NATURAL WATERCOURSE OF THE DRAINAGE AREA.
  - (c) AVOID CONCENTRATING SURFACE WATER ANYWHERE EXCEPT SWALES OR WATERCOURSES.
  - (d) PREVENT MUD FROM BEING TRACKED ONTO THE PUBLIC ROADWAY BY TRAVELING OVER A TEMPORARY GRAVEL CONSTRUCTION ENTRANCE OR WASHING OFF VEHICLE TIRES BEFORE ENTERING A PUBLIC OR PRIVATE DRIVEWAY.
- (3) SLOPE CONSTRUCTION**
- (a) MINIMIZE LENGTH AND STEEPNESS OF SLOPES BY BENCHING, TERRACING OR CONSTRUCTING DIVERSION STRUCTURES.
  - (b) PRESERVE, MATCH, OR BLEND CUTS AND FILLS WITH THE NATURAL CONTOURS AND UNDULATIONS OF THE LAND.
  - (c) ROUND SHARP ANGLES AT THE TOP AND SIDES OF CUT AND FILL SLOPES.
  - (d) MAINTAIN CUT AND FILL SLOPES AT LESS THAN TWO-TO-ONE (2:1, RUN:RISE) SLOPE UNLESS A GEOLOGICAL AND ENGINEERING ANALYSIS INDICATES THAT STEEPER SLOPES ARE SAFE AND EROSION AND SEDIMENT CONTROL MEASURES CAN SUCCESSFULLY PREVENT EROSION.
- (4) PROTECTION OF WATERCOURSES AND DRAINAGE INLETS**
- (a) PREPARE DRAINAGEWAYS TO HANDLE CONCENTRATED OR INCREASED RUNOFF FROM DISTURBED AREAS BY USING APPROPRIATE LINING MATERIALS OR ENERGY ABSORBING DEVICES TO REDUCE THE VELOCITY OF RUNOFF WATER.
  - (b) TRAP SEDIMENT-LADEN RUNOFF IN BASINS TO ALLOW SOIL PARTICLES TO SETTLE OUT BEFORE FLOWS ARE RELEASED TO RECEIVING WATERS, STORM DRAINS, STREETS OR ADJACENT PROPERTY. THIS STANDARD IS NOT MANDATORY FOR GRADING THE SITE IS FULLY WINTERIZED AND STABILIZED PRIOR TO AND WHEN CONDUCTED BETWEEN APRIL 15 AND OCTOBER 15. REMOVE TRAPPED SEDIMENT TO A SUITABLE LOCATION ON-SITE OR AT A DISPOSAL SITE APPROVED BY THE COUNTY.
  - (c) DO NOT GRADE OR DRIVE EQUIPMENT IN A STREAMSIDE MANAGEMENT OR OTHER WET AREAS EXCEPT AS ALLOWED THROUGH THE COUNTY STREAMSIDE MANAGEMENT AREA ORDINANCE.
  - (d) DEPOSIT OR STORE EXCAVATED MATERIALS AWAY FROM WATERCOURSES.
  - (e) PROTECT ALL EXISTING OR NEWLY INSTALLED STORM DRAINAGE STRUCTURES FROM SEDIMENT CLOGGING.
  - (f) USE STRAW BALES, FILTER FABRIC WRAPS AND DRAINAGE INLET PROTECTIONS IN A MANNER THAT DOES NOT CAUSE ADDITIONAL EROSION OR FLOODING OF A ROADWAY.
- (5) DISPOSAL OF EXCAVATED MATERIALS**
- (a) STOCKPILE TOPSOIL ON THE SITE FOR USE ON AREAS TO BE REVEGETATED.
  - (b) PLACE STOCKPILED SOIL IN LOCATIONS, SO THAT IF EROSION OCCURS, IT WILL NOT CONTRIBUTE TO OFFSITE SEDIMENT DISCHARGE.
  - (c) PROTECT STOCKPILED SOIL PROMPTLY THROUGH THE USE OF APPROPRIATE BMPs TO REDUCE THE RISK OF EROSION AND SEDIMENT TRANSPORT. APPLY MULCH OR OTHER PROTECTIVE COVERINGS ON STOCKPILED MATERIAL THAT WILL BE EXPOSED THROUGH THE WINTER SEASON.
  - (d) DISPOSE OF EXCAVATED MATERIAL NOT USED AT THE SITE AT A LOCATION APPROVED BY THE COUNTY.
- (6) DUST CONTROL**
- (a) ALL CONSTRUCTION AREAS, INCLUDING DISPOSAL SITES, SHALL BE TREATED AND MAINTAINED AS NECESSARY TO MINIMIZE THE EMISSION OF DUST. MAINTENANCE SHALL BE CONDUCTED AS NECESSARY TO PREVENT A NUISANCE TO OFFSITE PROPERTIES.
  - (b) ALL CONSTRUCTION SITES, INCLUDING DRIVEWAYS, SHALL BE MAINTAINED AS NECESSARY TO MINIMIZE THE EMISSION OF DUST AND PREVENT THE CREATION OF A NUISANCE TO ADJACENT PROPERTIES.
- (7) REVEGETATION**
- (a) APPLY TEMPORARY SEEDING AND MULCHING TO DENUDED AREAS PRIOR TO OCTOBER 15 UNLESS THE PROJECT IS CONDITIONED OTHERWISE.
  - (b) ESTABLISH A PERMANENT VEGETATIVE COVER ON DENUDED AREAS NOT OTHERWISE STABILIZED. PERMANENT VEGETATION GROUND COVER MUST CONTROL SOIL EROSION SATISFACTORILY AND SURVIVE SEVERE WEATHER CONDITIONS.
  - (c) RETAIN A VEGETATIVE BARRIER WHENEVER POSSIBLE AROUND PROPERTY BOUNDARIES.
  - (d) USE SELF-SUSTAINING, NON-INVASIVE PLANTS THAT REQUIRE LITTLE OR NO MAINTENANCE AND DO NOT CREATE AN EXTREME FIRE HAZARD.
  - (e) USE NATIVE PLANT SPECIES WHENEVER FEASIBLE.

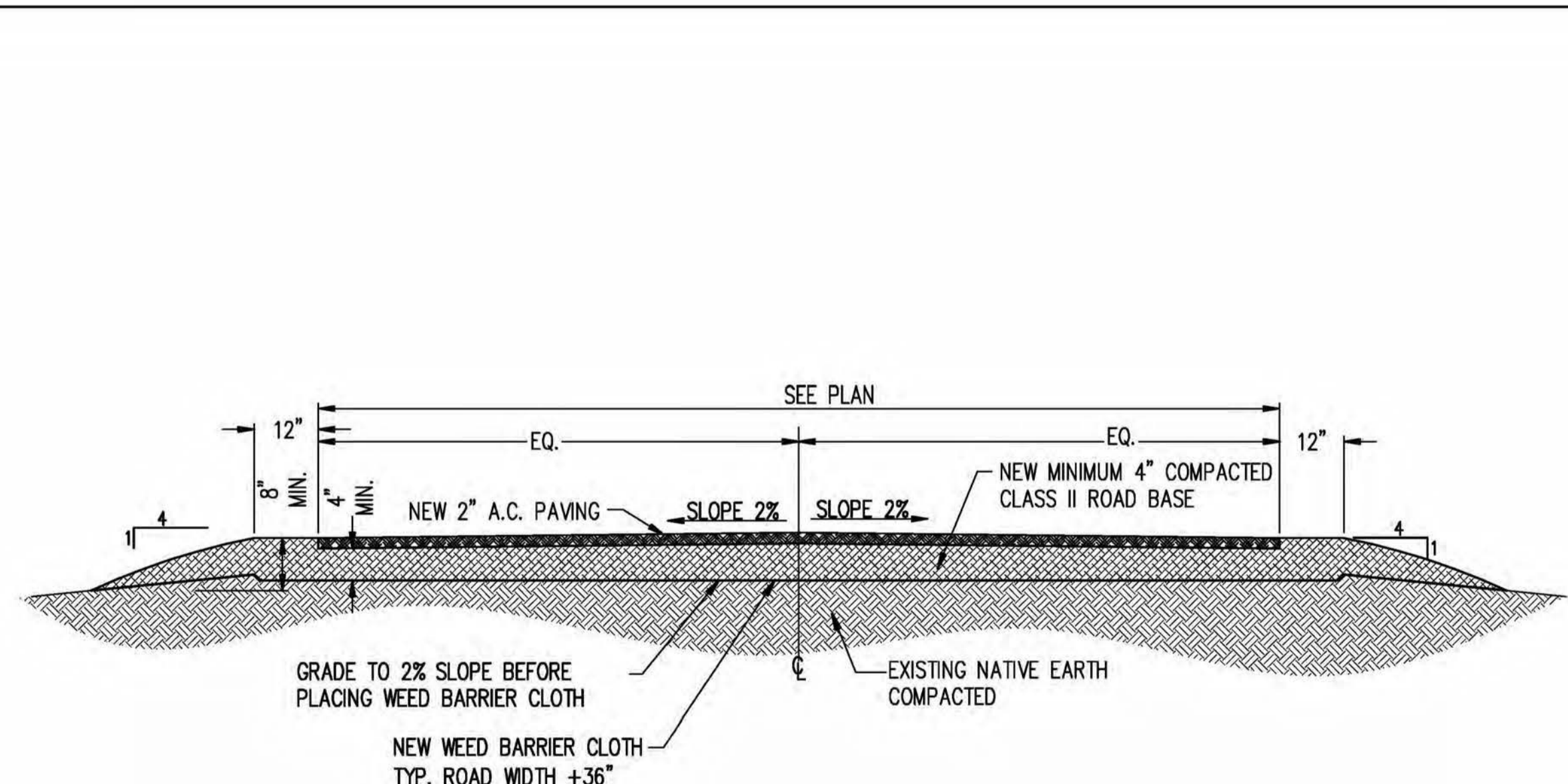

TYP. A/C ROAD SECTION SCALE: N.T.S. 1

PROPRIETARY INFORMATION  
 THE INFORMATION CONTAINED IN THIS SET OF DRAWINGS IS PROPRIETARY BY NATURE. ANY USE OR DISCLOSURE OTHER THAN THAT WHICH RELATES TO PEEK SITE-COM IS STRICTLY PROHIBITED

CLIENT: \_\_\_\_\_



5001 EXECUTIVE PKWY  
 SAN RAMON, CA 94583

PROJECT INFORMATION:

**ZEE ESTATES**  
 GATE LANE 1,000' SOUTH EAST OF THE INTERSECTION OF GATE LANE AND SALMON FALLS ROAD  
 PILOT HILL, CA 95664

REV#	DATE	DESCRIPTION	BY
1	6-29-17	90% ZONING DOC'S	RB
1	8-3-17	90% ZONING DOC'S	ALP
2	8-9-17	100% ZONING DOC'S	ALP

COORDINATING ENGINEER: \_\_\_\_\_

**Peek Site-Com**  
 12852 Earhart Ave, Suite 101  
 Auburn, California 95602  
 Phone (530) 885-6160  
 E-Mail info@peeksitecom.com

SEAL: \_\_\_\_\_



SITE #: \_\_\_\_\_ CHK.: \_\_\_\_\_ DRAWN BY: \_\_\_\_\_  
 CVL03629 ... RB

SHEET TITLE: **GRADING NOTES & DETAILS**

SHEET NUMBER: **C-4** REVISION: **0**

PROPRIETARY INFORMATION  
 THE INFORMATION CONTAINED IN THIS SET OF DRAWINGS IS PROPRIETARY BY NATURE. ANY USE OR DISCLOSURE OTHER THAN THAT WHICH RELATES TO PEEK SITE-COM IS STRICTLY PROHIBITED

CLIENT:



5001 EXECUTIVE PKWY  
 SAN RAMON, CA 94583

PROJECT INFORMATION:

**ZEE ESTATES**

GATE LANE 1,000' SOUTH EAST OF THE INTERSECTION OF GATE LANE AND SALMON FALLS ROAD  
 PILOT HILL, CA 95664

REV: DATE: DESCRIPTION: BY:

REV	DATE	DESCRIPTION	BY
1	6-29-17	90% ZONING DOC'S	RB
1	8-3-17	90% ZONING DOC'S	ALP
2	8-9-17	100% ZONING DOC'S	ALP

COORDINATING ENGINEER:

**Peek Site-Com**

12852 Earhart Ave. Suite 101  
 Auburn, California 95602  
 Phone (530) 885-6160  
 E-Mail info@peeksitecom.com

SEAL:



SITE #: CVL03629 CHK.: ... DRAWN BY: RB

SHEET TITLE: PRELIMINARY GRADING PLAN

SHEET NUMBER: C-5 REVISION: 0

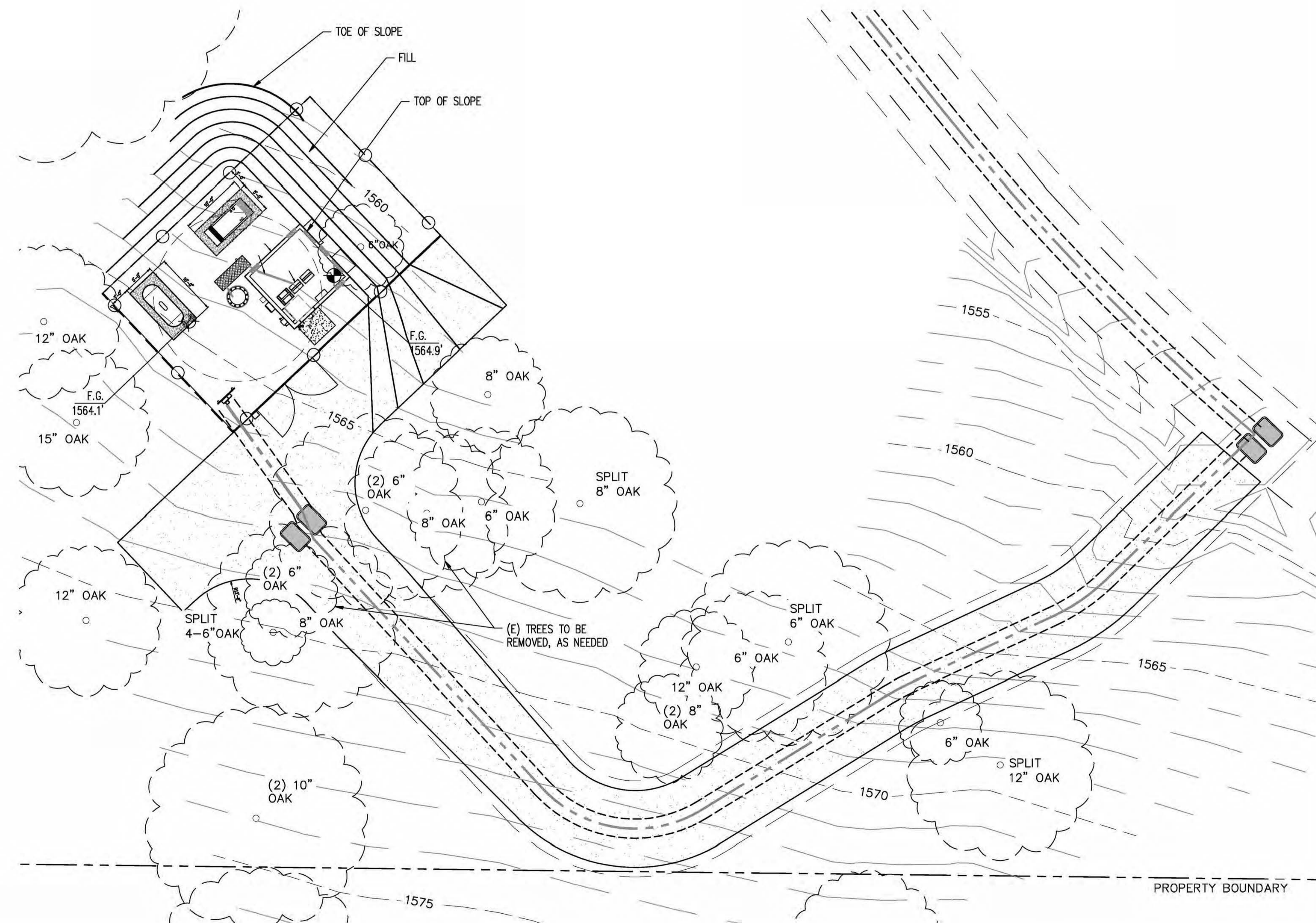

PRELIMINARY GRADING PLAN

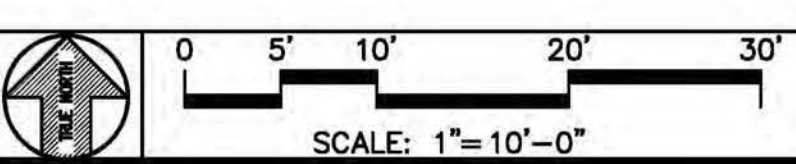



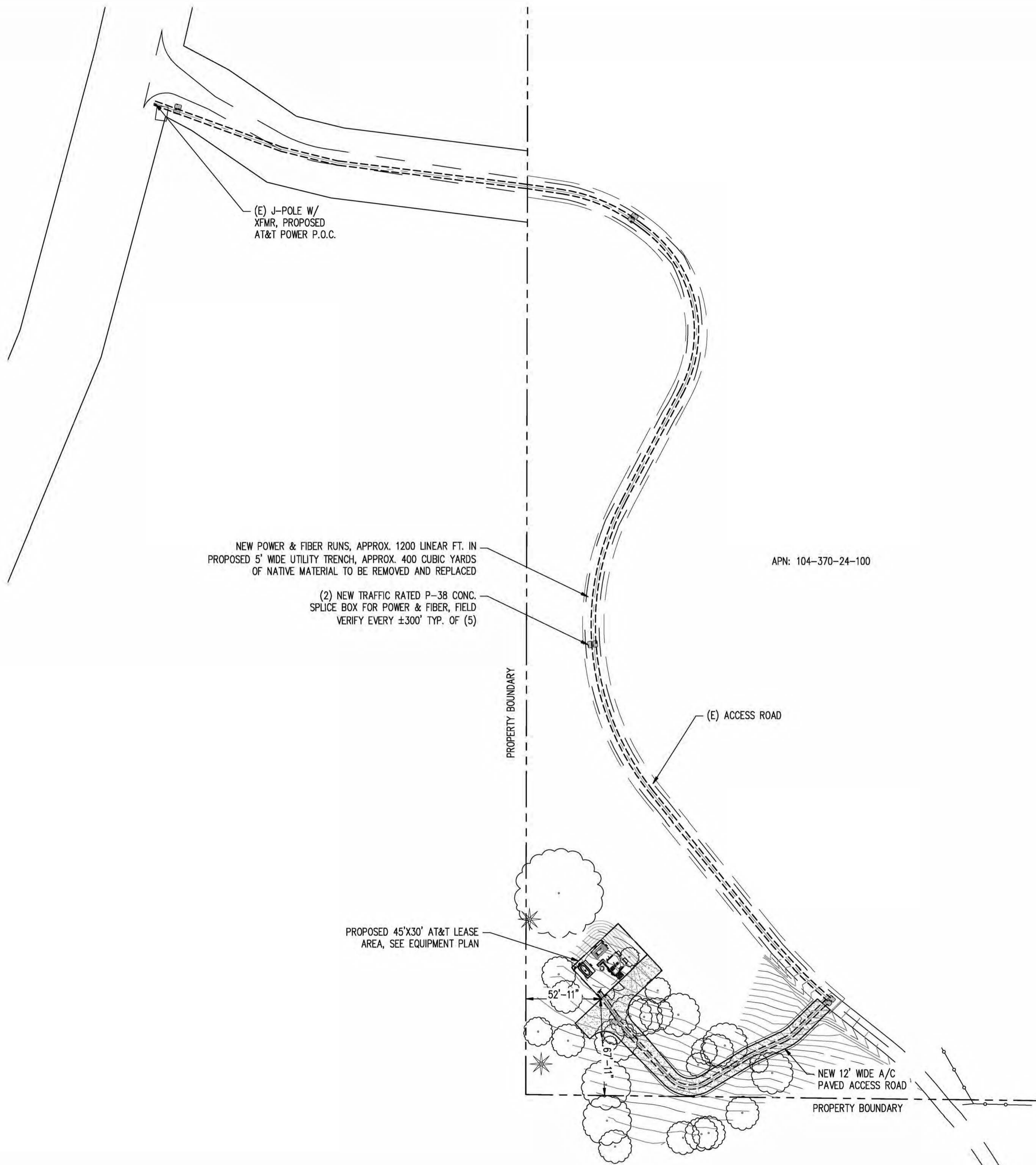

APN: 104-370-24-100

PROPRIETARY INFORMATION  
 THE INFORMATION CONTAINED IN THIS SET OF DRAWINGS IS PROPRIETARY BY NATURE. ANY USE OR DISCLOSURE OTHER THAN THAT WHICH RELATES TO PEEK SITE-COM IS STRICTLY PROHIBITED

CLIENT:



5001 EXECUTIVE PKWY  
 SAN RAMON, CA 94583

PROJECT INFORMATION:  
**ZEE ESTATES**  
 GATE LANE 1,000' SOUTH EAST OF THE INTERSECTION OF GATE LANE AND SALMON FALLS ROAD  
 PILOT HILL, CA 95664

REV: DATE: DESCRIPTION: BY:

1	6-29-17	90% ZONING DOC'S	RB
1	8-3-17	90% ZONING DOC'S	ALP
2	8-9-17	100% ZONING DOC'S	ALP

COORDINATING ENGINEER:

**Peek Site-Com**  
 12852 Earhart Ave. Suite 101  
 Auburn, California 95602  
 Phone (530) 885-6160  
 E-Mail info@peeksitecom.com

SEAL:



SITE #: CVL03629    CHK.: ...    DRAWN BY: RB

SHEET TITLE:  
**SITE PLAN**

SHEET NUMBER: **A-1**    REVISION: **0**

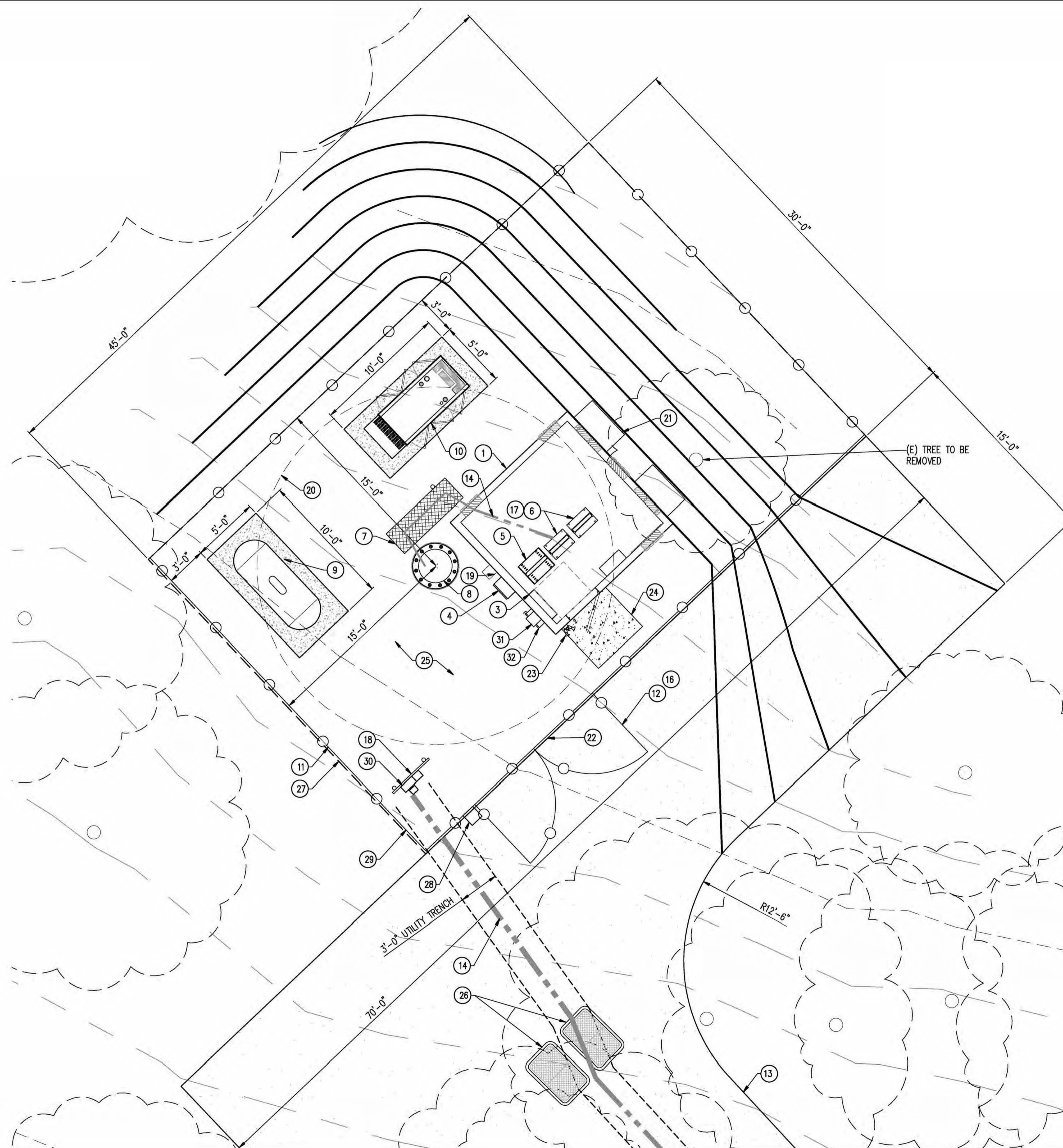

**KEY NOTES**

1. NEW 11' x 12' LIGHTWEIGHT PRE-FAB "MIC" EQUIPMENT SHELTER
2. (1) NEW GPS ANTENNA
3. NEW ELEC. PANEL, PROVIDED WITH SHELTER
4. TELCO BOX, PROVIDED WITH SHELTER
5. NEW D/C POWER PLANT, PROVIDED WITH SHELTER
6. NEW 23" FIF RACK, PROVIDED WITH SHELTER, TYP. OF (2)
7. NEW HEAVY DUTY METAL CABLE TRAY LID W/ CONG. SLEEPERS EVERY 4'
8. NEW 160' MONOPINE
9. NEW 500 GAL LP PROPANE TANK ON NEW CONC. SLAB
10. NEW 35 KW LP PROPANE BACK UP GENERATOR ON NEW CONC. SLAB
11. NEW 6'-0" CHAIN LINK FENCE W/ VINYL SLATS
12. NEW 12' WIDE DOUBLE ACCESS GATE
13. NEW 12' WIDE A/C PAVED ACCESS ROAD
14. NEW U/G POWER AND TELCO CONDUITS
15. NEW CAMLOCK GENERATOR INTERFACE
16. NEW CARRIER CONTACT SIGNAGE AT GATE
17. NEW CIENA WITHIN FIF RACK
18. NEW UTILITY RACK
19. NEW 2A-20BC RATED FIRE EXTINGUISHER IN WEATHER RESISTANT CABINET
20. 24" MAX BRANCH DIAMETER AT BASE OF POLE
21. NEW HVAC, PROVIDED WITH SHELTER
22. OUTLINE OF NEW TOWER MAT FOUNDATION 32'X32', VERIFY WITH ENGINEERING
23. NEW OUTDOOR LIGHTS PROVIDED WITH SHELTER, W/ TIMER AND MOTION SENSOR
24. NEW CONC. STOOP
25. NEW MIN. 2" CLEAN CRUSHED ROCK OVER 4" CLASS II ROAD BASE OVER WEED BARRIER FABRIC
26. NEW P48 PULL BOXES FOR TELCO AND POWER
27. NEW AT&T 30'X45' LEASE AREA
28. NEW FIRE DEPT. KNOX BOX
29. NEW SOUND BLANKET
30. NEW 200 AMP METER/ MAIN PANEL
31. NEW CAMLOCK GENERATOR INTERFACE
32. NEW 200A DISCONNECT

**EQUIPMENT PLAN**

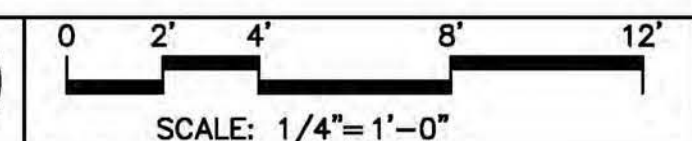

1

**PROPRIETARY INFORMATION**

THE INFORMATION CONTAINED IN THIS SET OF DRAWINGS IS PROPRIETARY BY NATURE. ANY USE OR DISCLOSURE OTHER THAN THAT WHICH RELATES TO PEEK SITE-COM IS STRICTLY PROHIBITED

CLIENT:



5001 EXECUTIVE PKWY  
SAN RAMON, CA 94583

PROJECT INFORMATION:

**ZEE ESTATES**

GATE LANE 1,000' SOUTH EAST OF THE INTERSECTION OF GATE LANE AND SALMON FALLS ROAD  
PILOT HILL, CA 95664

REV: = DATE: DESCRIPTION: BY:

REV:	DATE:	DESCRIPTION:	BY:
1	6-29-17	90% ZONING DOC'S	RB
1	8-3-17	90% ZONING DOC'S	ALP
2	8-9-17	100% ZONING DOC'S	ALP

COORDINATING ENGINEER:

**Peek Site-Com**

12852 Earhart Ave. Suite 101  
Auburn, California 95602  
Phone (530) 885-6160

E-Mail info@peeksitecom.com

SEAL:



SITE #: CHK.: DRAWN BY:

CVL03629	...	RB
----------	-----	----

SHEET TITLE:

**EQUIPMENT PLAN**

SHEET NUMBER: REVISION:

**A-2 0**

RF SCHEDULE

SECTOR/POS.	ANTENNA MODEL	RAD CENTER	PHYSICAL AZIMUTH	RRU	TMA	FIBER LENGTH	COAX LENGTH	COAX DIA.	NO.
A/1	QS6656-3	± 150'	90°	(1) RRUS-11 & (1) RRUS-32 B2	N/A	± 220'	± N/A	N/A	-
A/2	QS6656-3	± 150'	90°	(1) RRUS-12 & (1) RRUS-32 B66	N/A	± 220'	± N/A	N/A	-
A/3	QS6656-3	± 140'	90°	(1) RRUS-11	N/A	± 210'	± N/A	N/A	-
A/4	QS6656-3	± 140'	90°	(1) RRUS-32 B30	N/A	± 210'	± N/A	N/A	-
B/1	QS6656-3	± 150'	330°	(1) RRUS-11 & (1) RRUS-32 B2	N/A	± 220'	± N/A	N/A	-
B/2	QS6656-3	± 150'	330°	(1) RRUS-11, (1) RRUS-12 & (1) RRUS-32 B66	N/A	± 220'	± N/A	N/A	-
B/3	QS6656-3	± 140'	330°	(1) RRUS-32 B30	N/A	± 210'	± N/A	N/A	-
B/4	QS6656-3	± 140'	330°	(1) RRUS-32 B30	N/A	± 210'	± N/A	N/A	-
C/1	QS6656-3	± 150'	210°	(1) RRUS-11 & (1) RRUS-32 B2	N/A	± 220'	± N/A	N/A	-
C/2	QS6656-3	± 150'	210°	(1) RRUS-11, (1) RRUS-12 & (1) RRUS-32 B66	N/A	± 220'	± N/A	N/A	-
C/3	QS6656-3	± 140'	210°	(1) RRUS-32 B30	N/A	± 210'	± N/A	N/A	-
C/4	QS6656-3	± 140'	210°	(1) RRUS-32 B30	N/A	± 210'	± N/A	N/A	-

RF SCHEDULE

SCALE: N.T.S. 1

PROPRIETARY INFORMATION  
 THE INFORMATION CONTAINED IN THIS SET OF DRAWINGS IS PROPRIETARY BY NATURE. ANY USE OR DISCLOSURE OTHER THAN THAT WHICH RELATES TO PEEK SITE-COM IS STRICTLY PROHIBITED



PROJECT INFORMATION:

**ZEE ESTATES**  
 GATE LANE 1,000' SOUTH EAST OF THE INTERSECTION OF GATE LANE AND SALMON FALLS ROAD  
 PILOT HILL, CA 95664

REV: DATE: DESCRIPTION: BY:

1	6-29-17	90% ZONING DOC'S	RB
1	8-3-17	90% ZONING DOC'S	ALP
2	8-9-17	100% ZONING DOC'S	ALP

COORDINATING ENGINEER:

**Peek Site-Com**  
 12852 Earhart Ave. Suite 101  
 Auburn, California 95602  
 Phone (530) 885-6160  
 E-Mail info@peeksitecom.com



SITE #: CVL03629 CHK: ... DRAWN BY: RB

ANTENNA PLAN & DETAILS

SHEET NUMBER: **A-3** REVISION: **0**

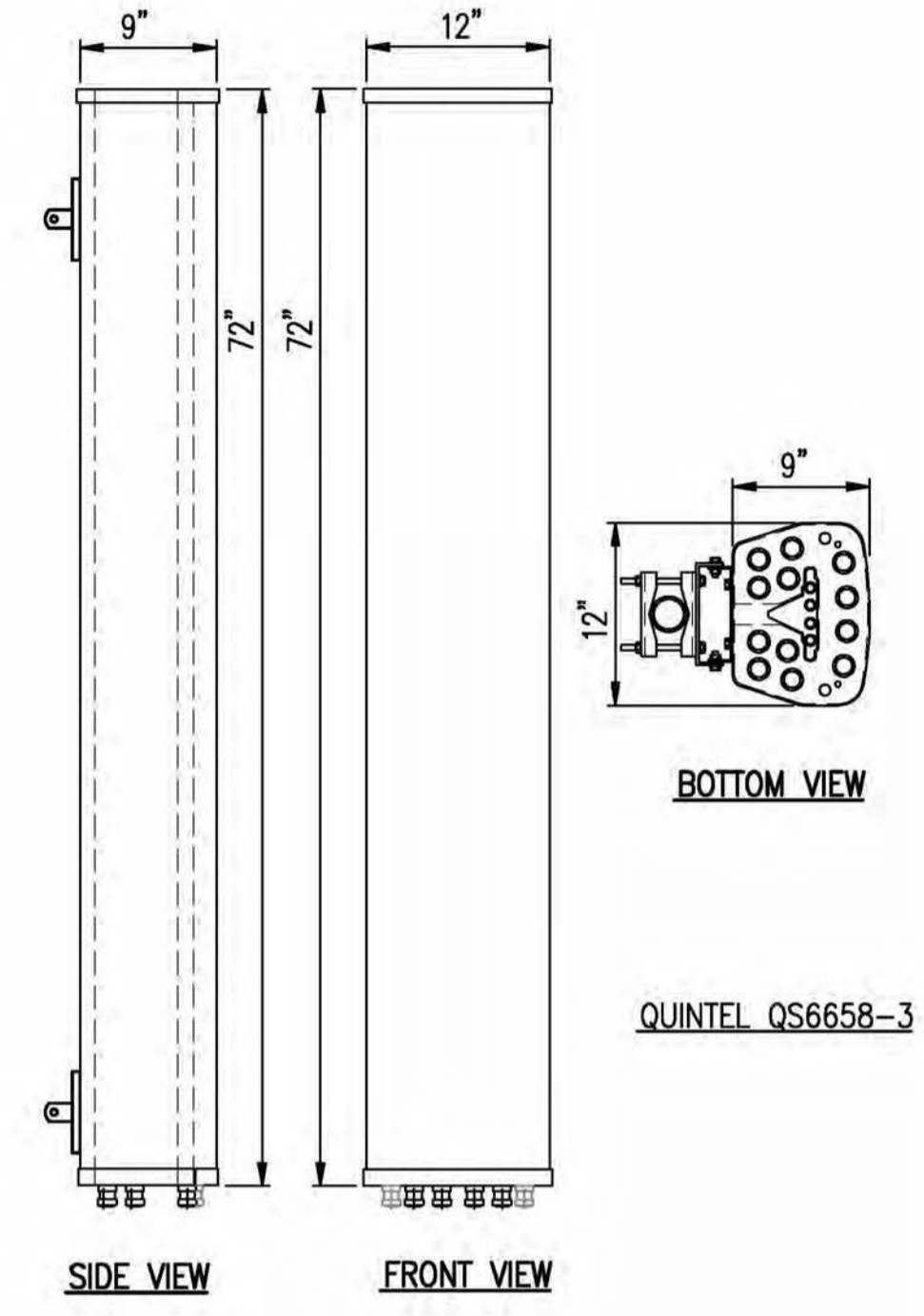
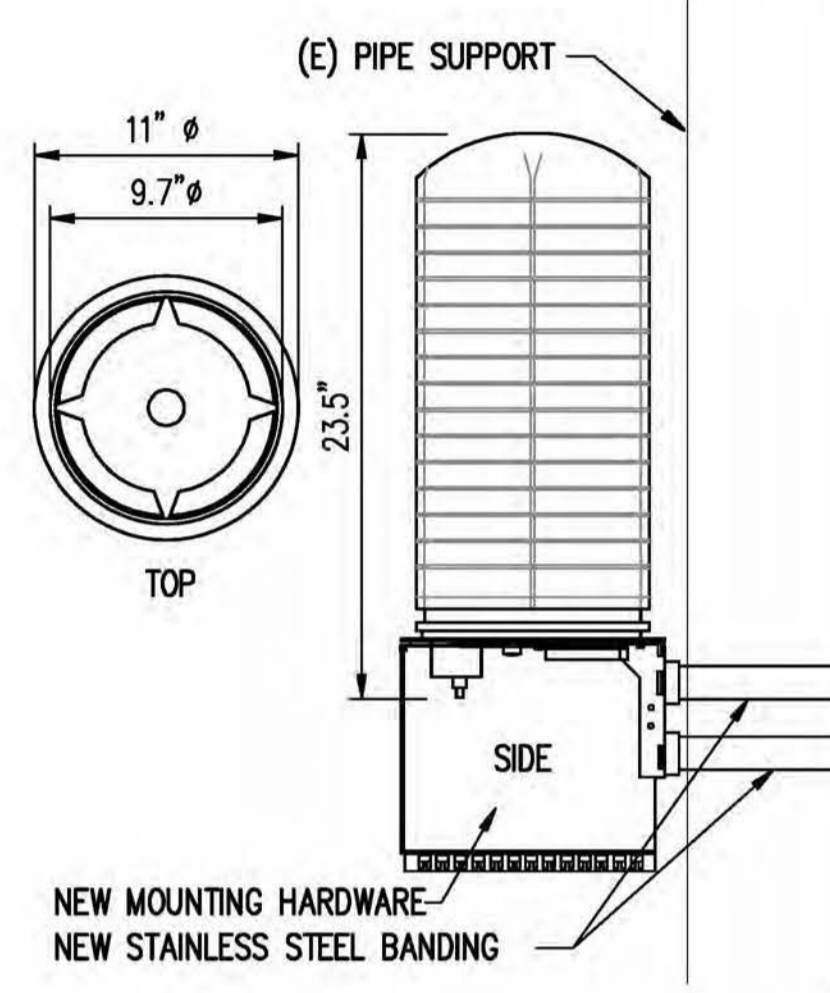

SURGE SUPP. DETAIL SCALE: N.T.S. 5 ANTENNA DETAIL SCALE: N.T.S. 3

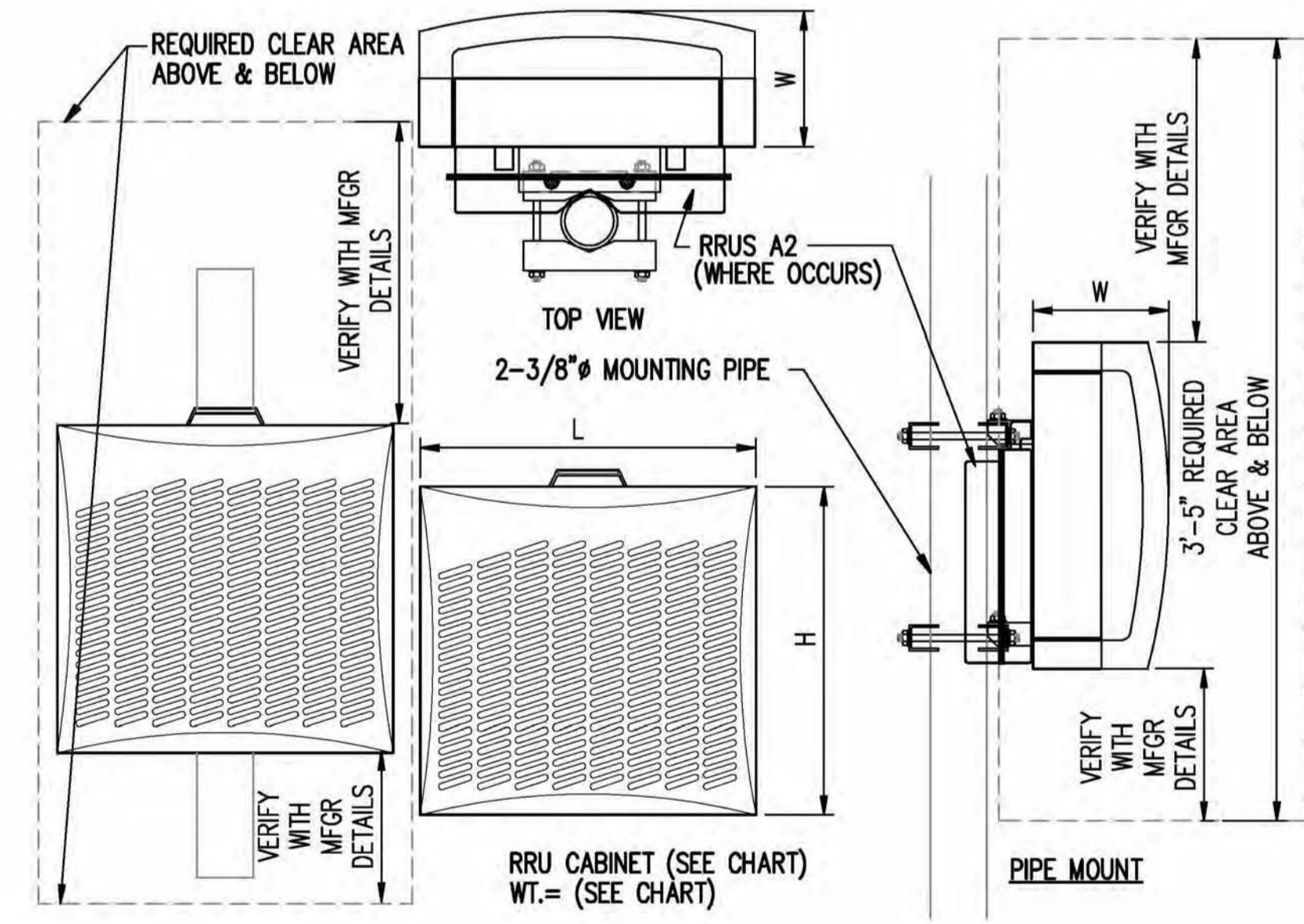

TYPE	LENGTH	HEIGHT	WIDTH	WEIGHT
RRU-11	17.8"	17.3"	7.19"	50 LBS
RRUS-E2	20.4"	18.5"	7.5"	50 LBS
RRUS-32	29.9"	13.3"	9.5"	60 LBS
RRU-12	20.4"	18.5"	7.5"	50 LBS
A2	12.8"	15"	3.5"	21 LBS

NOTE: SEE RF SHEET FOR RRU PLACEMENT

RRU DETAIL SCALE: N.T.S. 4

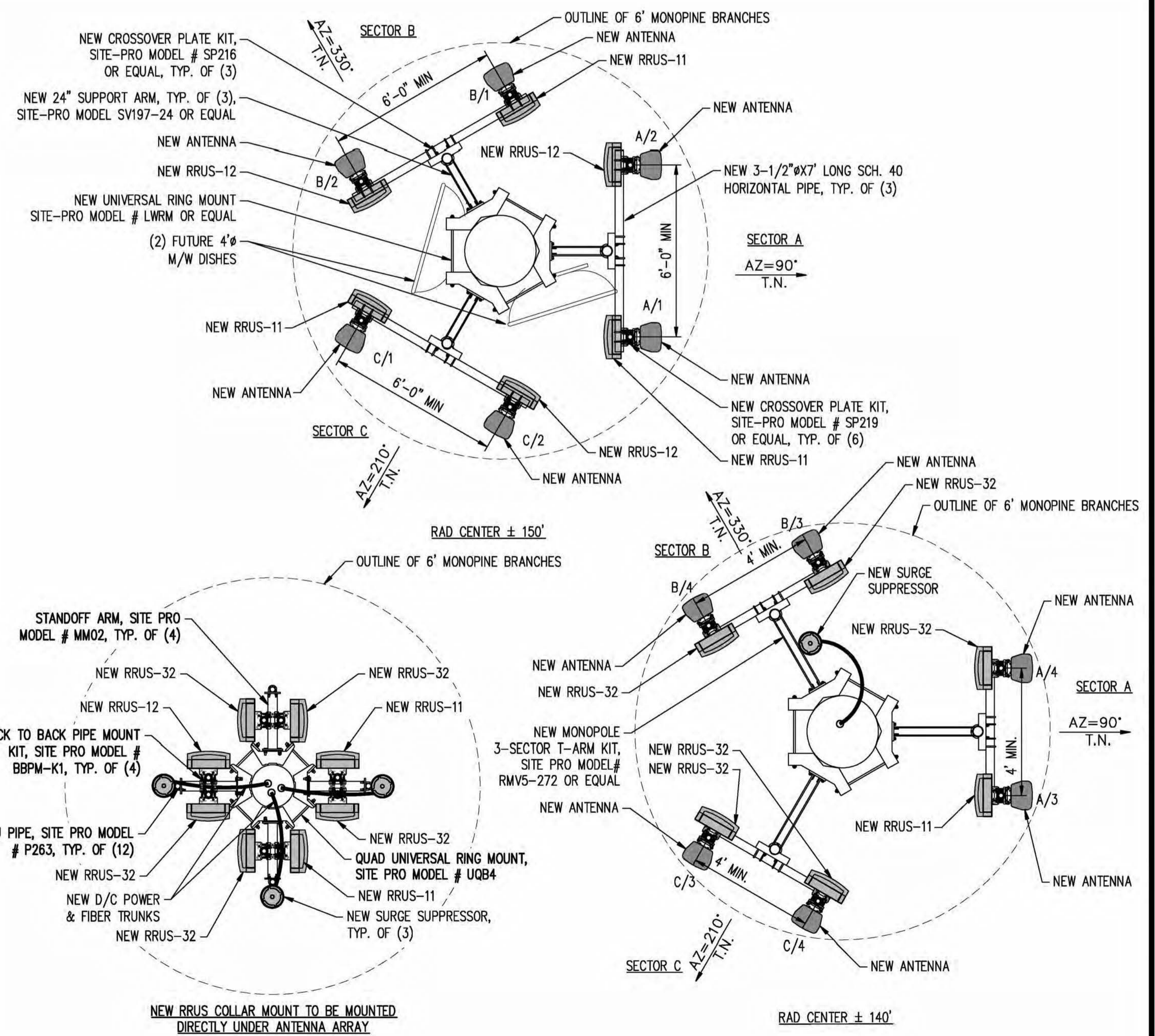

ANTENNA PLAN SCALE: 3/8"=1'-0" 2

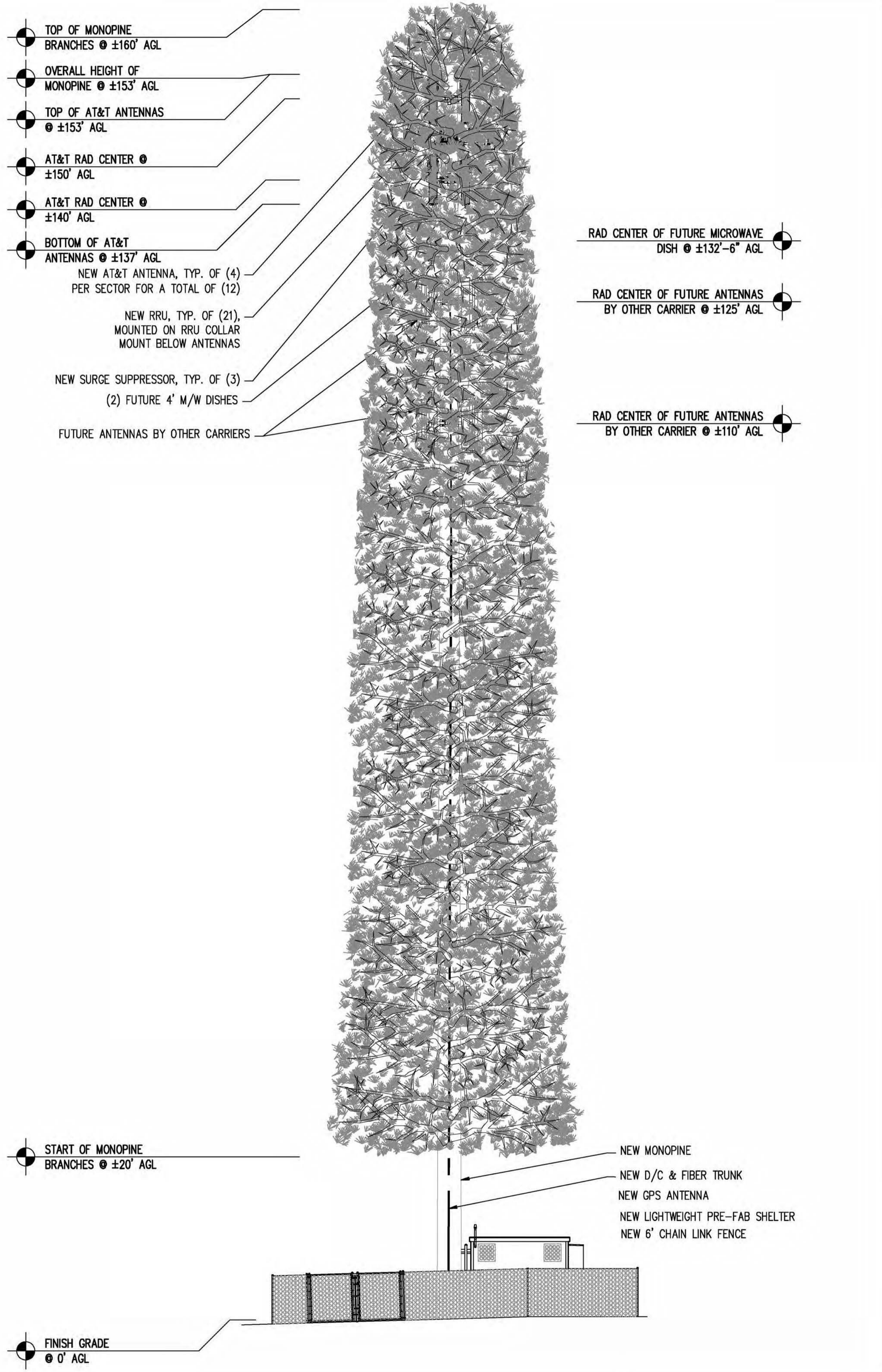

*SOUTH ELEVATION*

SCALE: 1/8"=1'-0" 2

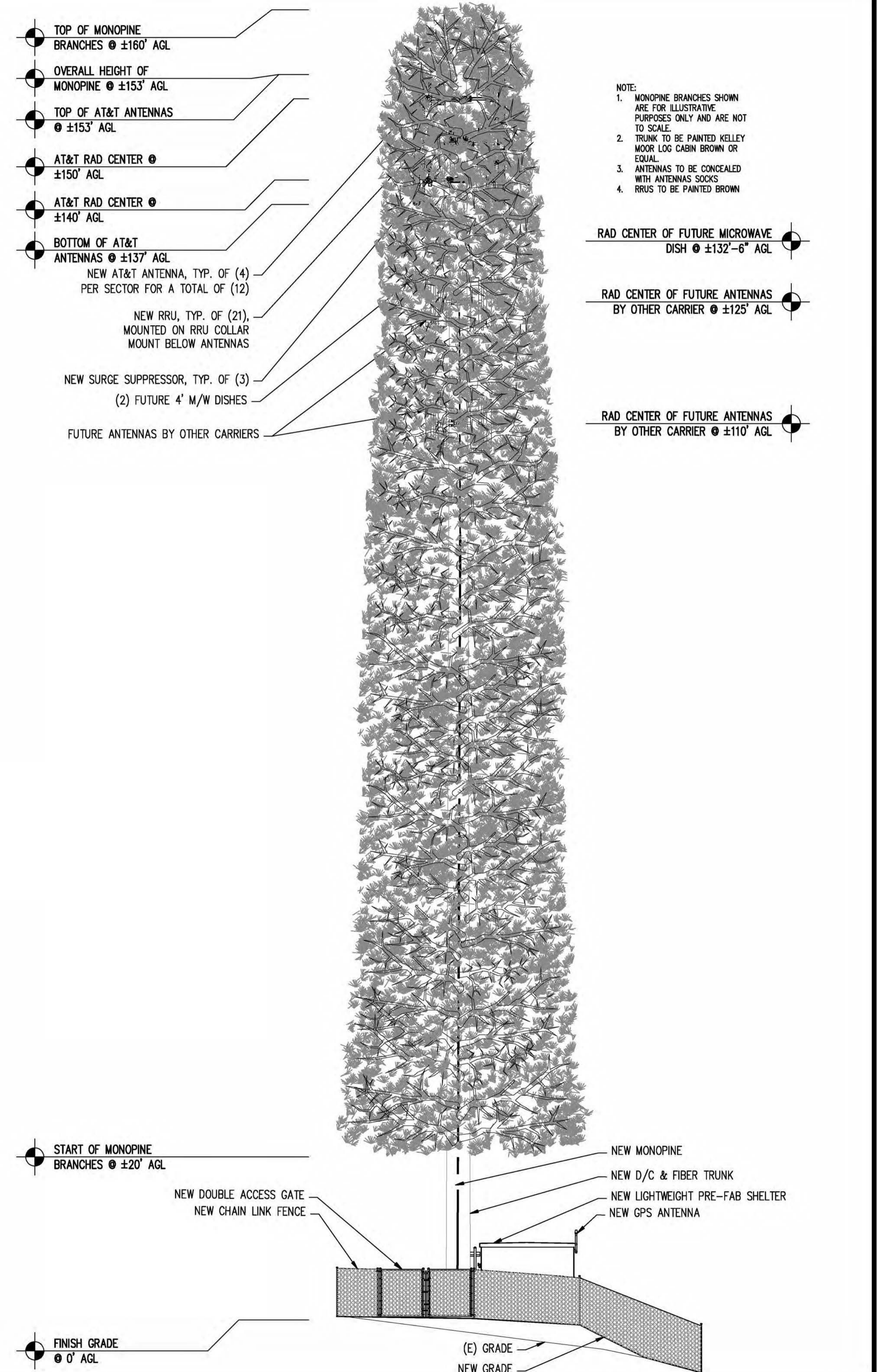

*NORTH ELEVATION*

SCALE: 1/8"=1'-0" 1

- NOTE:
- MONOPINE BRANCHES SHOWN ARE FOR ILLUSTRATIVE PURPOSES ONLY AND ARE NOT TO SCALE.
  - TRUNK TO BE PAINTED KELLEY MOOR LOG CABIN BROWN OR EQUAL.
  - ANTENNAS TO BE CONCEALED WITH ANTENNAS SOCKS
  - RRUS TO BE PAINTED BROWN

PROPRIETARY INFORMATION

THE INFORMATION CONTAINED IN THIS SET OF DRAWINGS IS PROPRIETARY BY NATURE. ANY USE OR DISCLOSURE OTHER THAN THAT WHICH RELATES TO PEEK SITE-COM IS STRICTLY PROHIBITED

CLIENT:

5001 EXECUTIVE PKWY  
SAN RAMON, CA 94583

PROJECT INFORMATION:

**ZEE ESTATES**  
GATE LANE 1,000' SOUTH EAST OF THE INTERSECTION OF GATE LANE AND SALMON FALLS ROAD  
PILOT HILL, CA 95664

REV.	DATE	DESCRIPTION	BY
1	6-29-17	90% ZONING DOC'S	RB
1	8-3-17	90% ZONING DOC'S	ALP
2	8-9-17	100% ZONING DOC'S	ALP

COORDINATING ENGINEER:

*Peek Site-Com*  
12852 Earhart Ave. Suite 101  
Auburn, California 95602  
Phone (530) 885-6160  
E-Mail info@peeksitcom.com

SEAL:

SITE #:	CHK.:	DRAWN BY:
CVL03629	...	RB

SHEET TITLE: **ELEVATIONS**

SHEET NUMBER: **A-4** REVISION: **0**

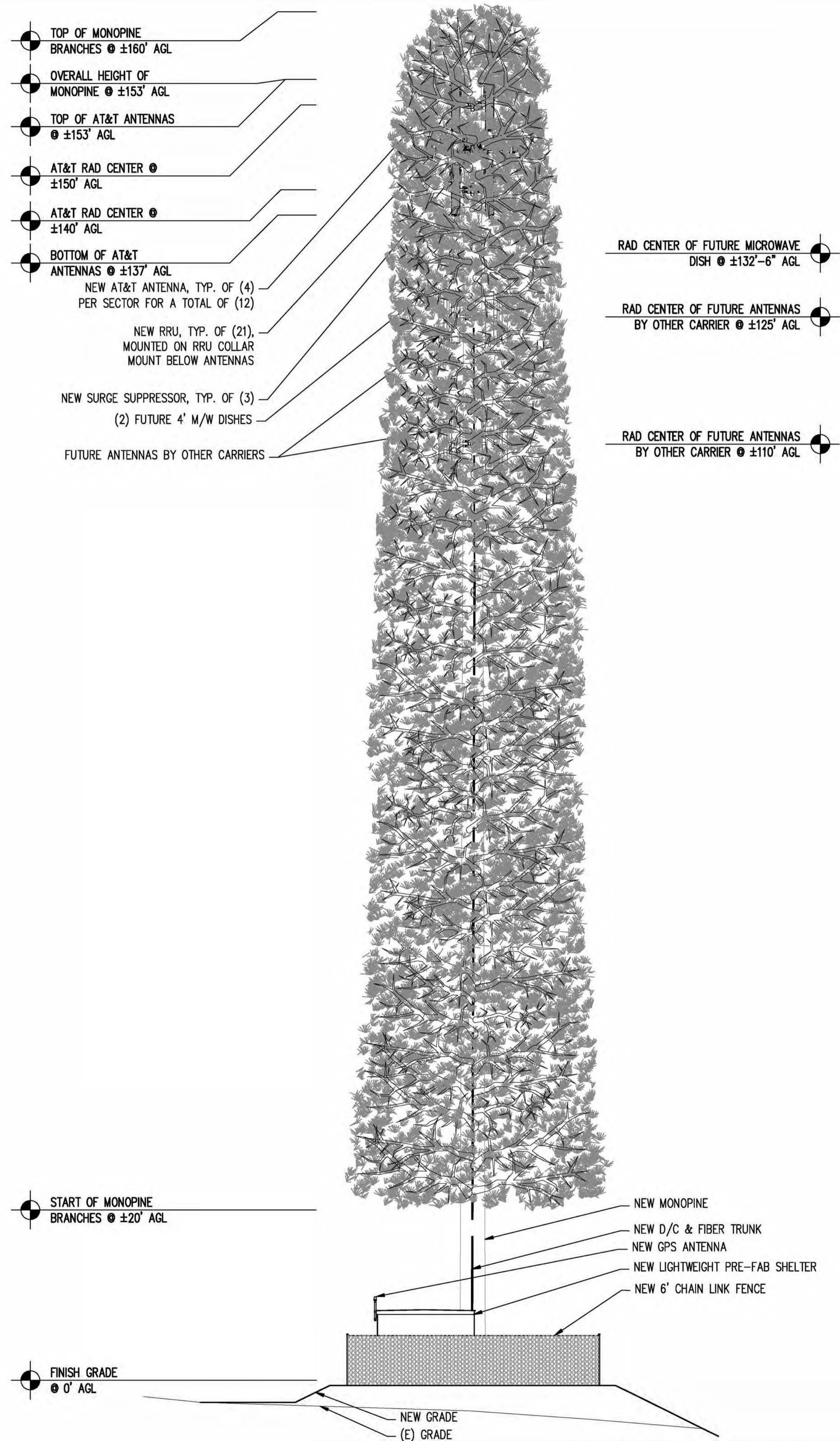

WEST ELEVATION

SCALE: 1/8"=1'-0"

2

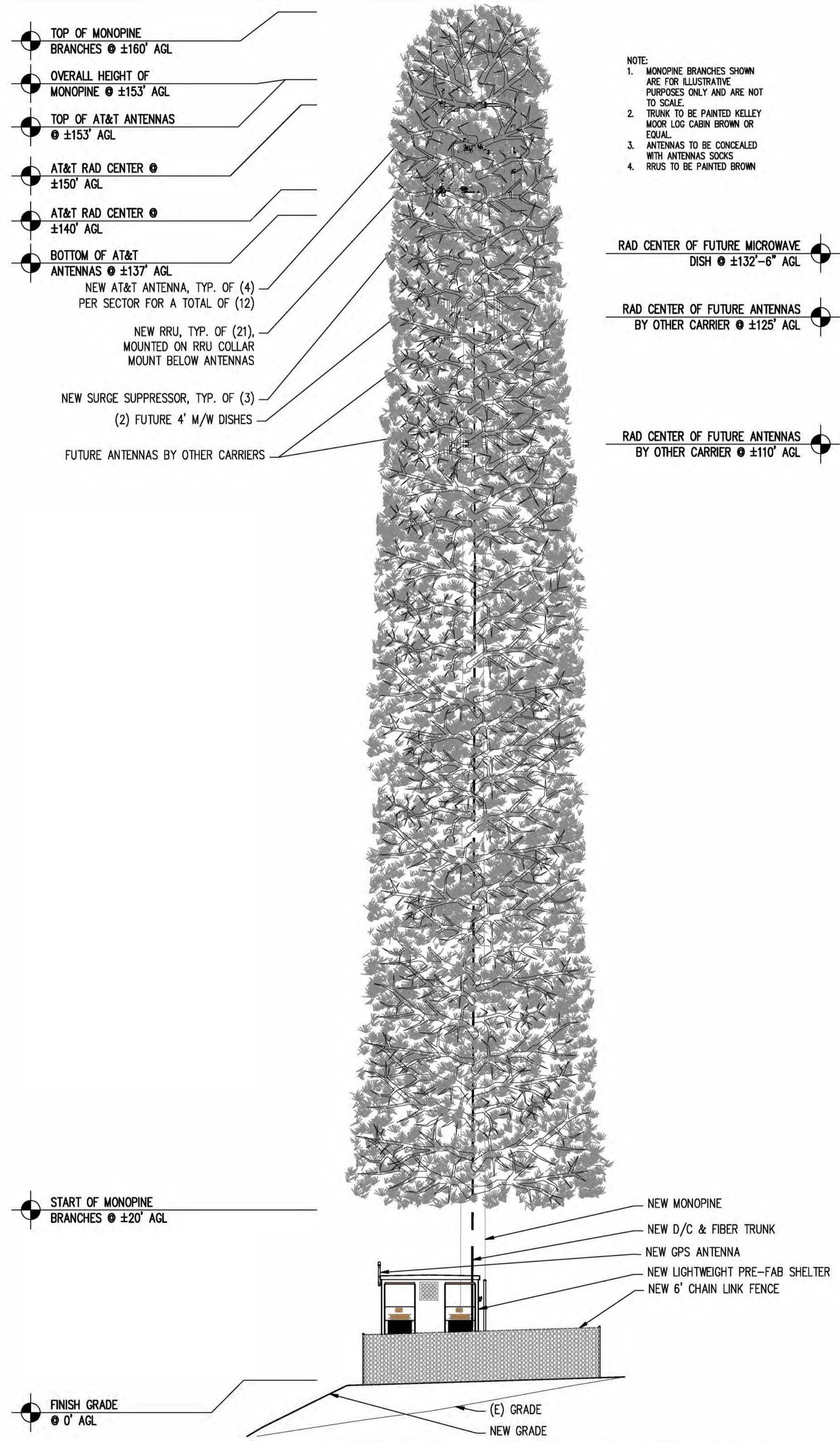

EAST ELEVATION

SCALE: 1/8"=1'-0"

1

NOTE:  
 1. MONOPINE BRANCHES SHOWN ARE FOR ILLUSTRATIVE PURPOSES ONLY AND ARE NOT TO SCALE.  
 2. TRUNK TO BE PAINTED KELLEY MOOR LOG CABIN BROWN OR EQUAL.  
 3. ANTENNAS TO BE CONCEALED WITH ANTENNAS SOCKS.  
 4. RRS TO BE PAINTED BROWN

PROPRIETARY INFORMATION  
 THE INFORMATION CONTAINED IN THIS SET OF DRAWINGS IS PROPRIETARY BY NATURE. ANY USE OR DISCLOSURE OTHER THAN THAT WHICH RELATES TO PEEK SITE-COM IS STRICTLY PROHIBITED

CLIENT:

5001 EXECUTIVE PKWY  
 SAN RAMON, CA 94583

PROJECT INFORMATION:

ZEE ESTATES  
 GATE LANE 1,000' SOUTH EAST OF THE INTERSECTION OF GATE LANE AND SALMON FALLS ROAD  
 PILOT HILL, CA 95664

REV.	DATE	DESCRIPTION	BY
1	6-29-17	90% ZONING DOC'S	RB
1	8-3-17	90% ZONING DOC'S	ALP
2	8-9-17	100% ZONING DOC'S	ALP

COORDINATING ENGINEER:

*Peek Site-Com*  
 12852 Earhart Ave. Suite 101  
 Auburn, California 95602  
 Phone (530) 885-6160  
 E-Mail info@peeksitecom.com

SITE #:	CHK.:	DRAWN BY:
CVL03629	...	RB

SHEET TITLE: **ELEVATIONS**

SHEET NUMBER: **A-4.1** REVISION: **0**

# CVL03629 Zoning Propagation Map

June 13, 2017

# EXISTING LTE 700 Coverage (RC = 150')

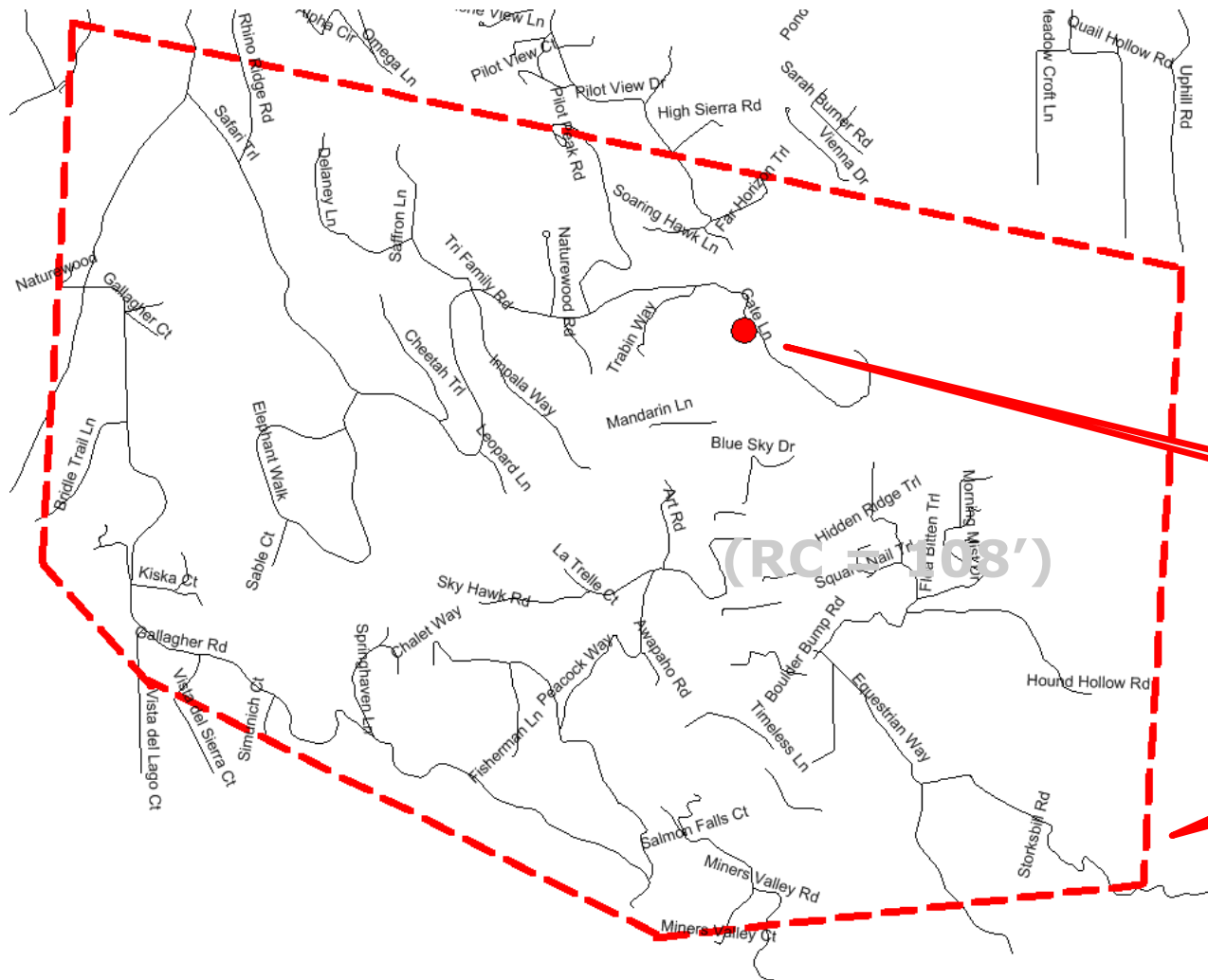

## Legend

- In-Building Service
- In-Transit Service
- Outdoor Service
- Existing site
- Proposed site

Zee Estates

Living Units Polygon



Scale: 1:22,660



June 13, 2017

# PROPOSED LTE 700 Coverage (RC = 150')

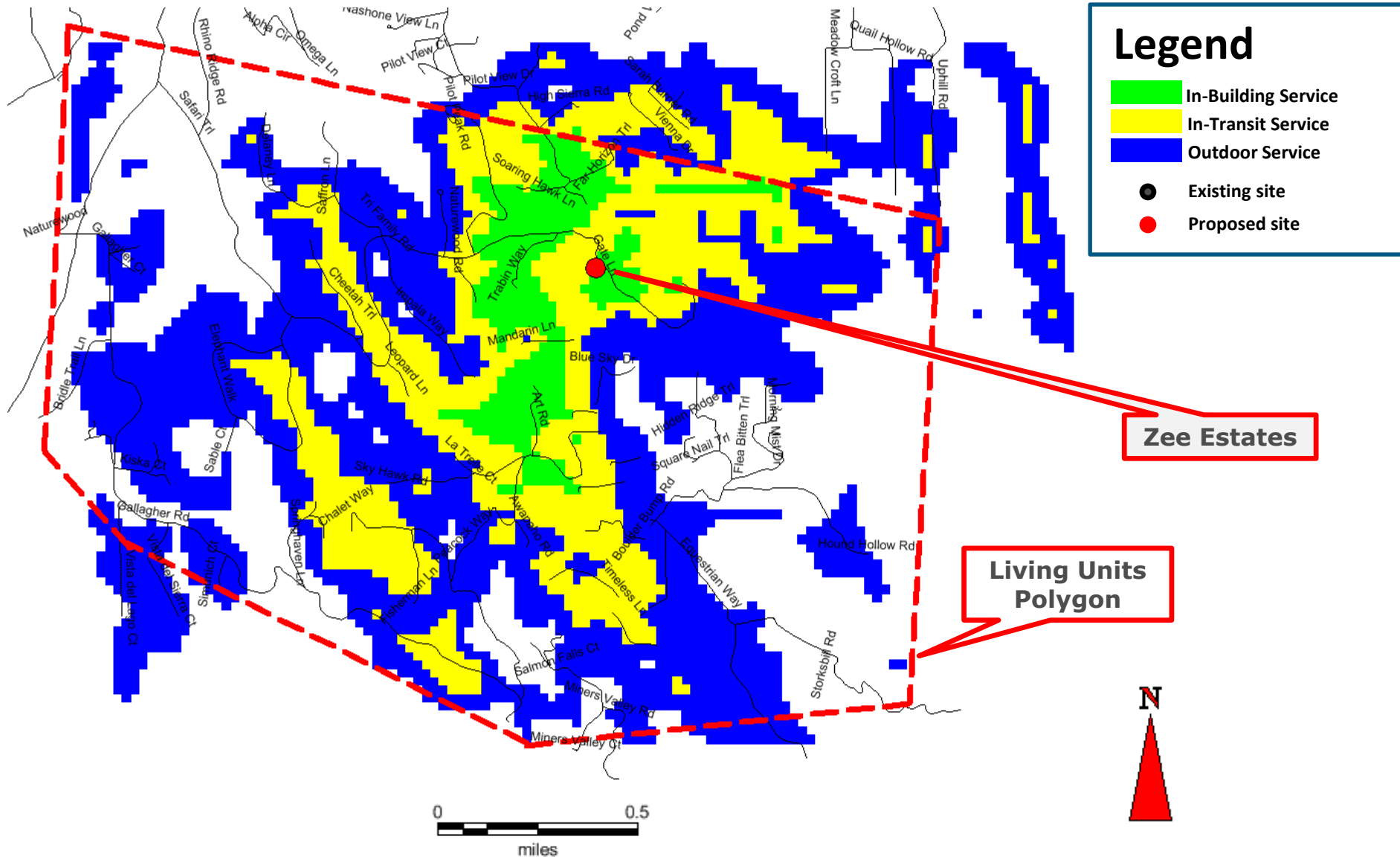

June 13, 2017



### Search Ring's Description and Objectives:

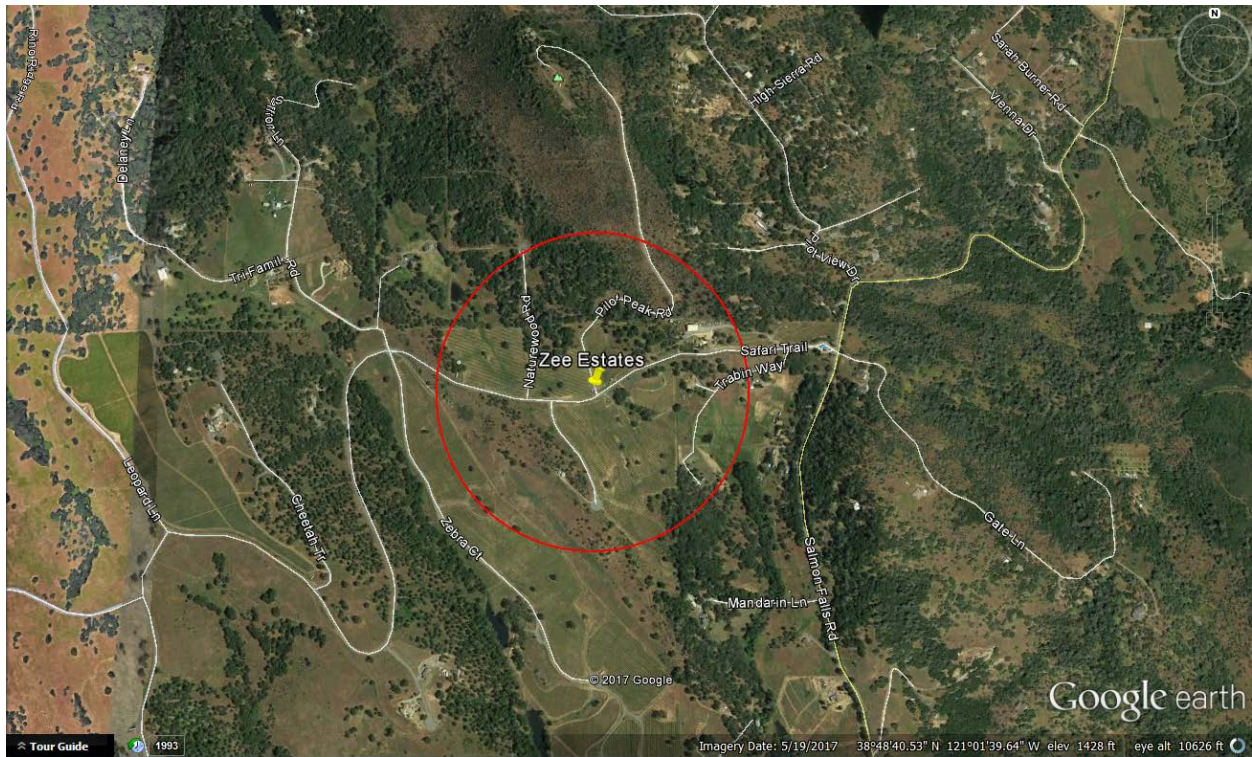

AT&T Mobility is proposing to build and maintain an unmanned wireless telecommunication facility consisting of a 30' x 45' (1350) square foot enclosed compound (lease area). The compound will include a 160 foot Stealth Monopine tower, one equipment shelter, one 35kw standby propane generator, and one 500 gallon propane tank. This facility will be located right off of Gate Lane, within El Dorado County's jurisdiction in a 60 acre LA-10 zone. The site is approximately 1.3 miles east of Acorn Creek and the area consists of evergreen trees, and rolling hills with rocky terrain.

AT&T's objective for the Zee Estates site is to provide wireless hi-speed broadband internet to a minimum of 255 LU's and cellular services to the nearby residences. This site is to provide hi-speed internet and enhanced cellular coverage & capacity to the Pilot Hill area, in all directions of the search ring which is a relatively dense underserved area. The site location's elevation is approximately 1,560 feet while the surrounding community's elevation averages around 1,450 feet, giving the homes within the community great potential for line of site to the tower. After running a coverage simulation at the site location, AT&T is anticipating meeting their FCC objective for this search ring by covering approximately 255 homes.

**Potential Co-locations:**

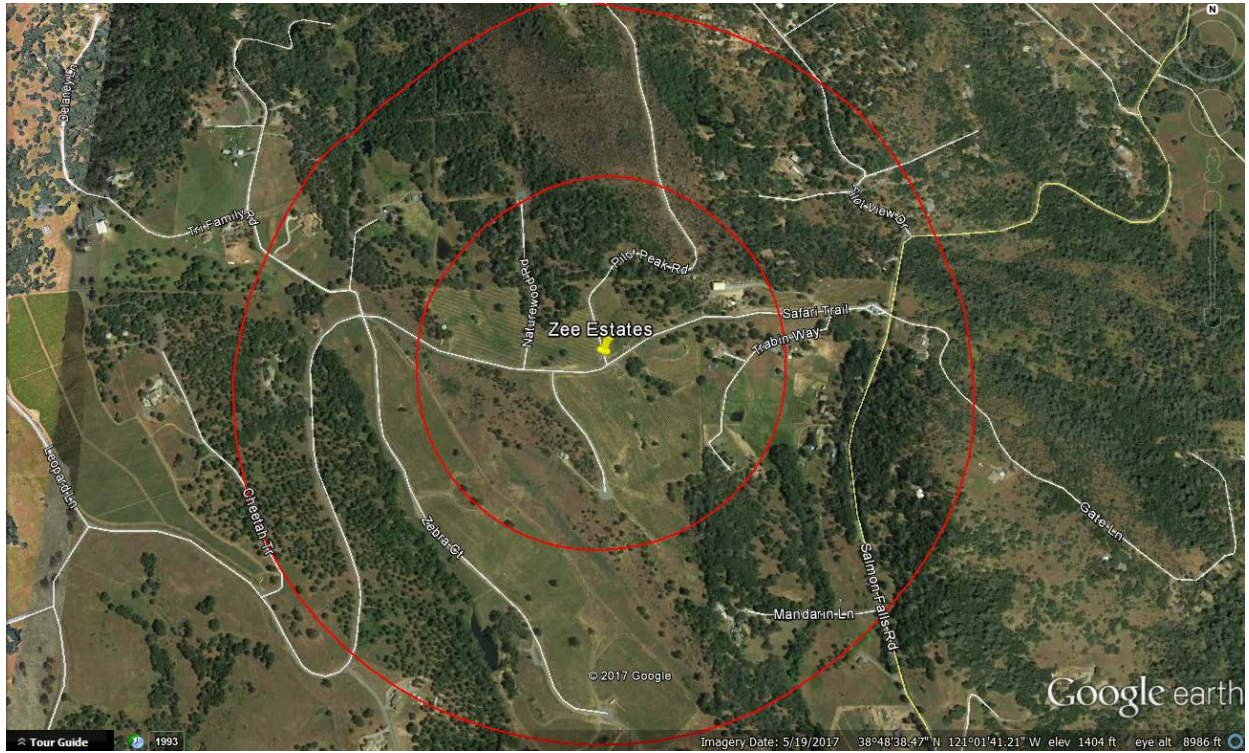

There are no potential Co-location opportunities in the near vicinity of the provided Search Ring. The targeted area is a relatively low populated area, therefore, typical cellular services are less prone to be present.

**Alternative Site Analysis pursuant to 17.14.210 (B) (1):**

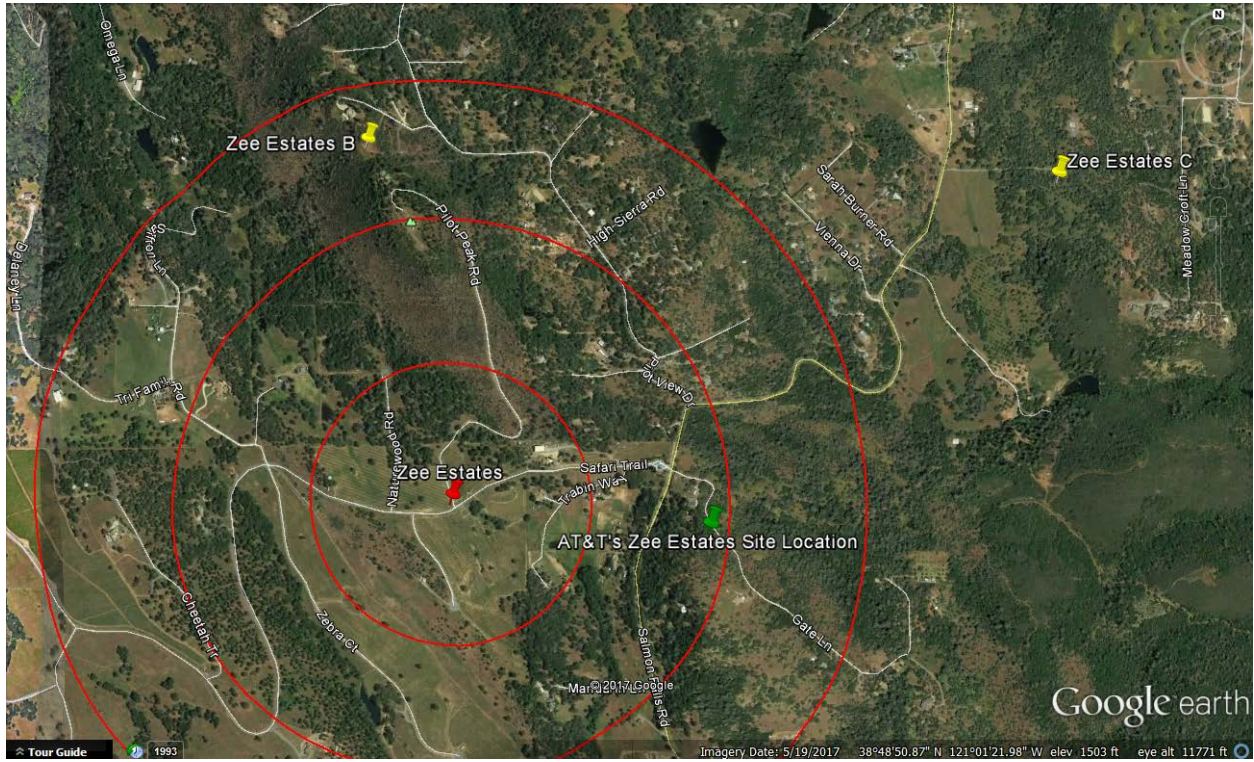

Above is a map showing the Search Ring (center is the red pin), Proposed Site (green pin) and the two alternative sites (yellow pins) that were considered for placement of the telecommunications facility. Each Alternative Site is discussed below:

**Zee Estates Alternative Candidate B:**

**4150 Pilot View Court, Pilot Hill, CA 95664**

**Latitude/Longitude: 38.819931, -121.031460**

**Proposal – New Tower**



**Considerations:**

Candidate B is located approximately 0.60 miles north of the center of AT&T's search ring. The proposed tower would be located on a 5.26 acre, RE-5 zoned property owned by Brian Cummings. The property is located on the south side of Pilot View Court and the site was proposed on the west side of the property. Candidate B was chosen as AT&T's second preferred candidate as the RF Engineer's simulation yielded fewer LU's than the subject site located at Gate Lane (Subject Parcel).

**Zee Estates Alternative Candidate C:**

**5081 Salmon Falls Road, Pilot Hill, CA 95664**

**Latitude/Longitude: 38.819348, -121.008285**

**Proposal – New Tower**



**Considerations:**

Candidate C is located approximately 1.2 miles north-east of the center of AT&T's search ring. The proposed tower would be located on a 145 acre, LA-10 zoned property owned by Richard and Ellen Wolfe. The property is located on the east side of Salmon Falls Road and the site was proposed on the north side of the property. Candidate C was chosen as AT&T's third preferred candidate as the RF Engineer's simulation yielded fewer LU's than the subject site located at Gate Lane (Subject Parcel).

**Actual View of the Proposed Location:**

The proposed lease area is located on the south-west side of the subject property. The site will not interfere with the existing use of the property. Access will be directly off of Gate Lane. The site is elevated above the surrounding area and has great potential for line of site to the communities down below the subject parcel.



# Attachment 4 Site 6 Zee Estates

*Existing*



*Proposed*

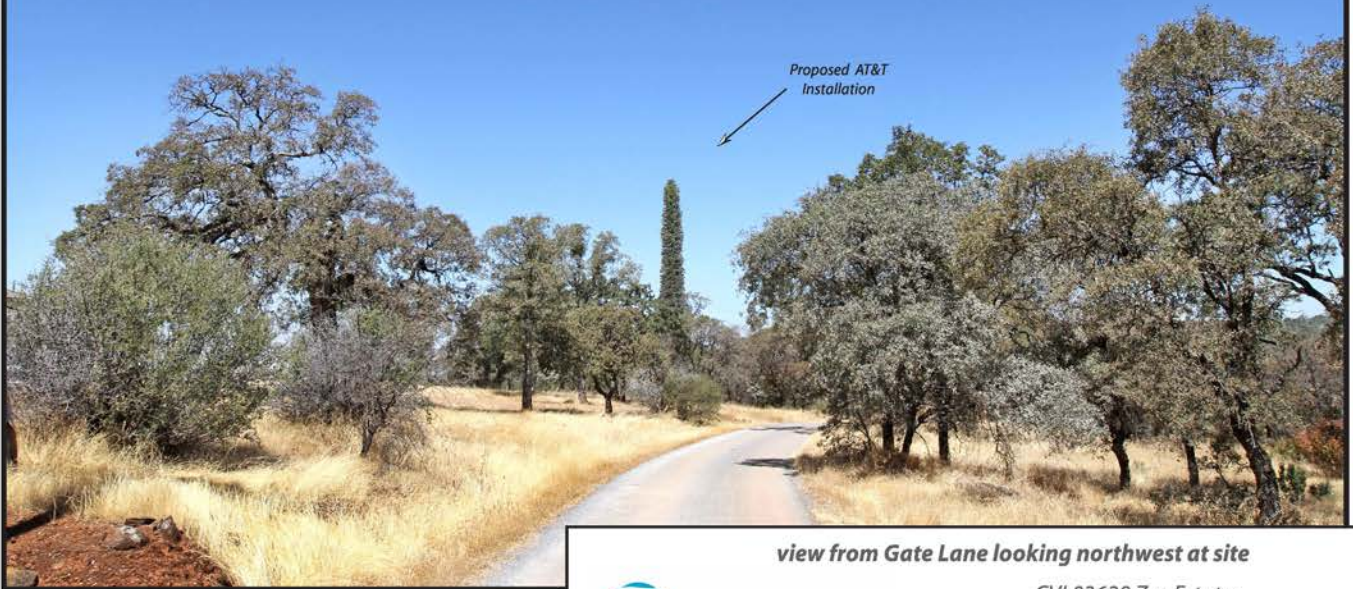

*view from Gate Lane looking northwest at site*



CVL03629 Zee Estates  
850 Gate Lane, Pilot Hill, CA  
Photosims Produced on 7-21-2017



*Existing*



*Proposed*



*view from Safari Trail looking southeast at site*



CVL03629 Zee Estates  
850 Gate Lane, Pilot Hill, CA  
Photosims Produced on 7-21-2017





*Existing*

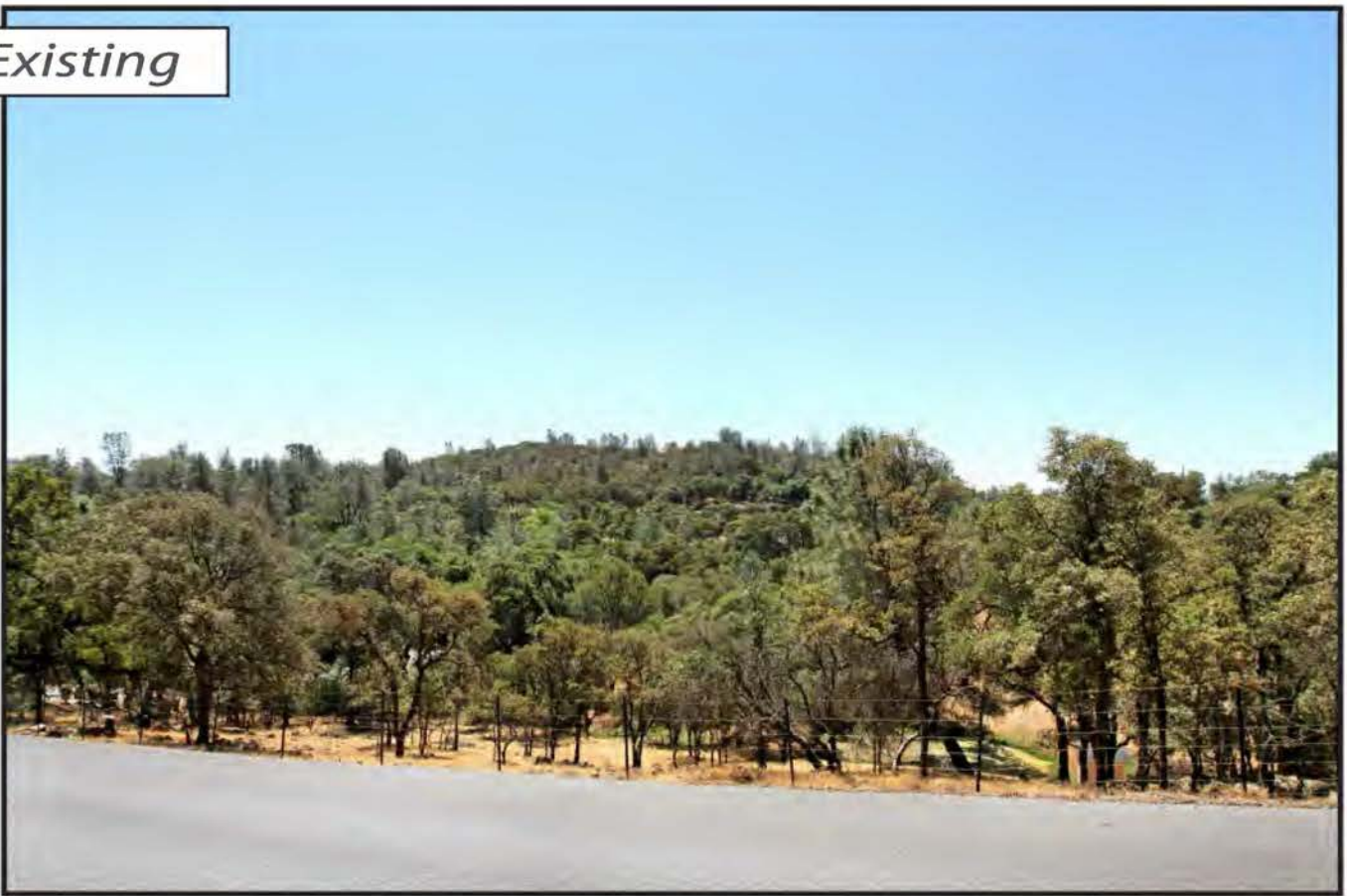

*Proposed*



*view from Pilot View Drive looking southeast at site*

*Existing*

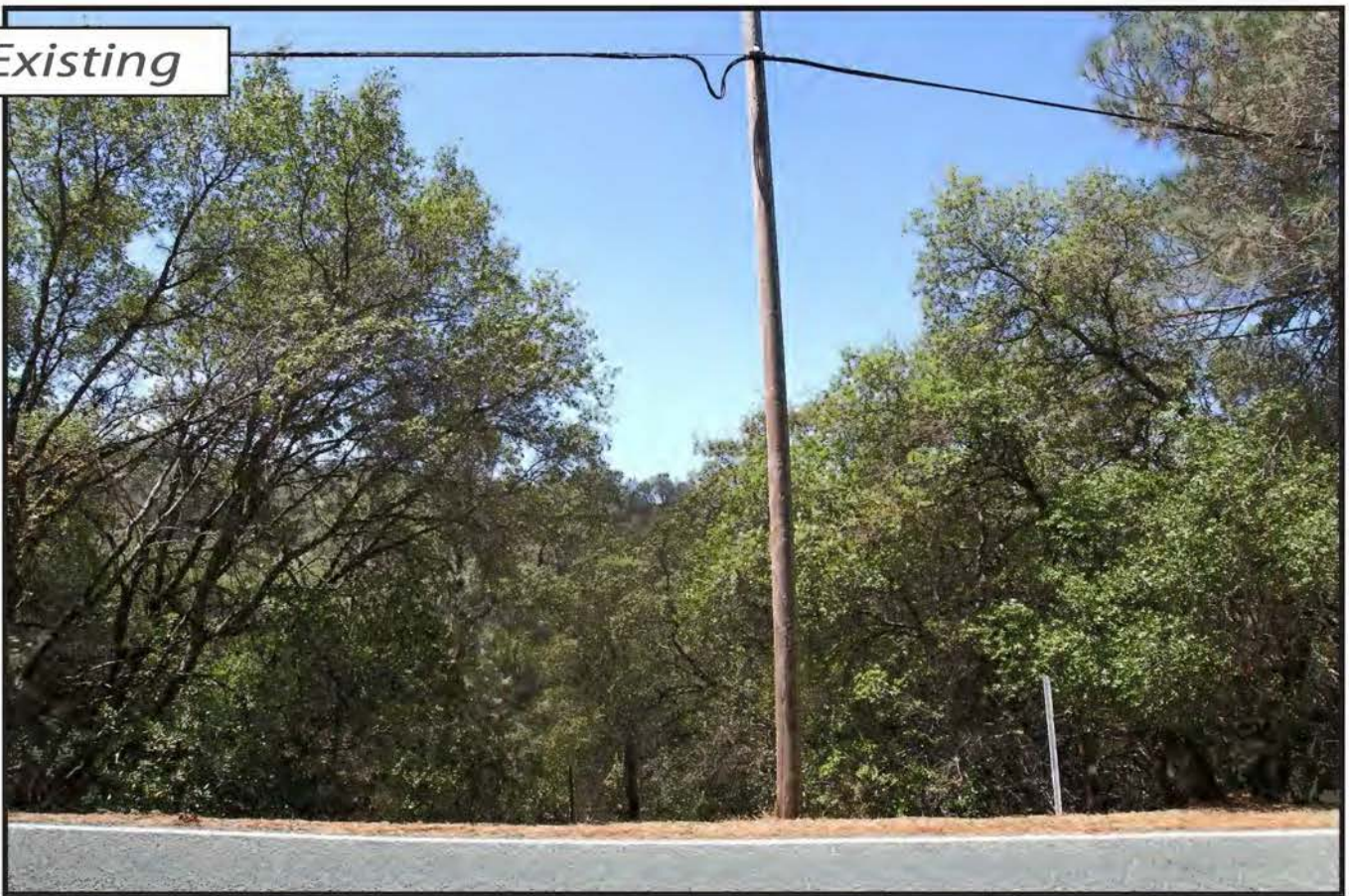

*Proposed*



*view from Salmon Falls Road looking southwest at site*

**AdvanceSim**  
Photo Simulation Solutions  
Contact (925) 202-8507

 **AT&T Wireless**

CVL03629 Zee Estates  
850 Gate Lane, Pilot Hill, CA  
Photosims Produced on 7-21-2017

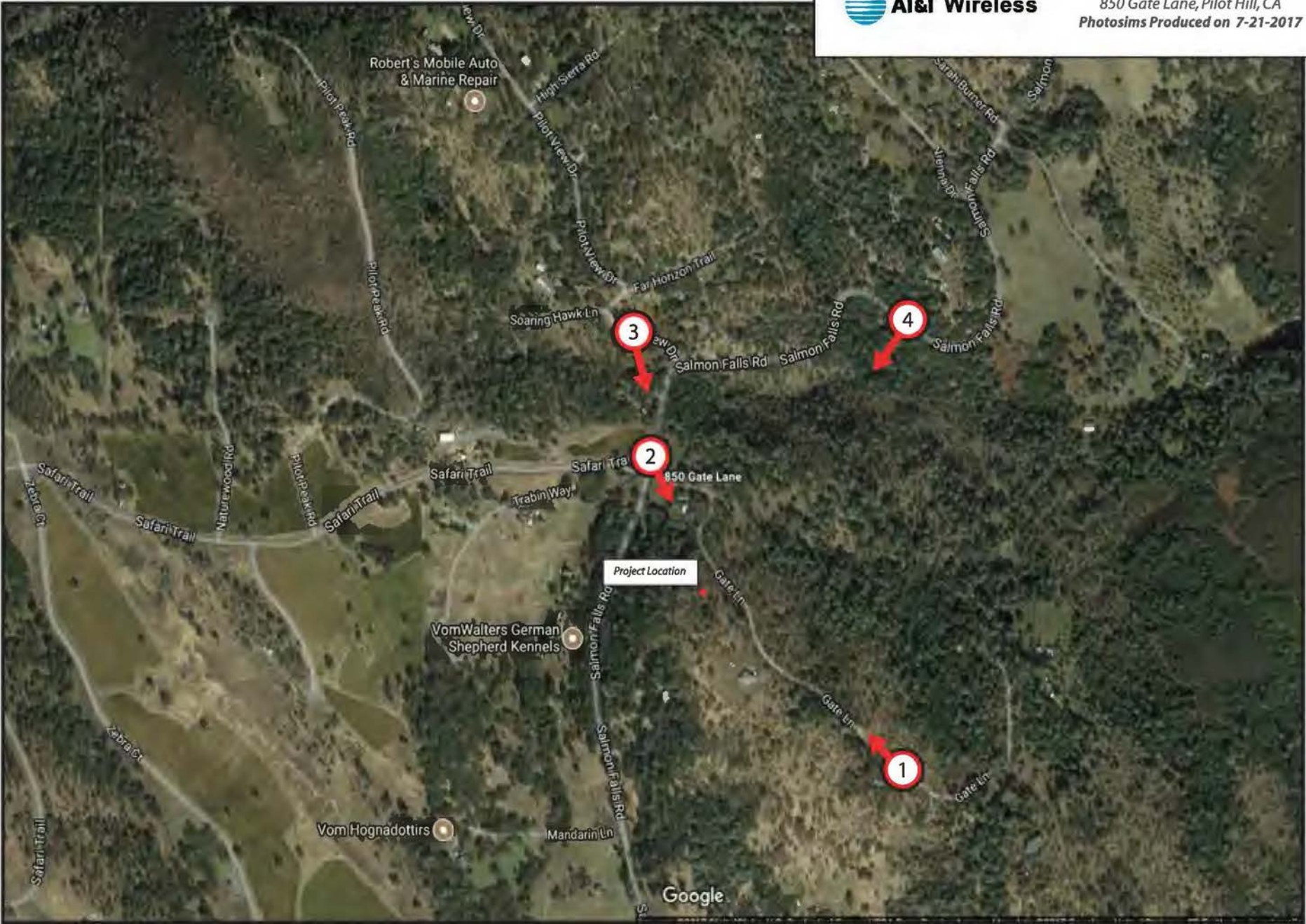

**Sound Specifications:**

- Emergency Generator Model: SG035 Generac
  - Average decibel (dBa) level at 23 feet = 64.9 dBa
- HVAC Model: ASDCA48
  - Average decibel (dBa) level at 50 feet = 57 dBa

**Sound Specifications while taking the Sound Blanket into consideration:**

- Emergency Generator Model: SG035 Generac
  - Average decibel (dBa) level at 23 feet = 58.11 dBa
- HVAC Model: ASDCA48
  - Average decibel (dBa) level at 50 feet = 46.36 dB

**Findings:**

1. Distance to the nearest property line = 40'
  - a. Generator Decibel level at 40' = 53.3 dBa
  - b. HVAC Decibel level at 40' = 48.3 dBa
2. Distance to alternative nearest property line = 75'
  - a. Generator Decibel level at 75' = 47.84 dBa
  - b. HVAC Decibel level at 75' = 42.84 dBa
3. Distance to a nearest residence = 310
  - a. Generator Decibel level at 310' = 35.52 dBa
  - b. HVAC Decibel level at 310' = 30.51 dBa

**Conclusion:**

After calculating all decibel levels at each nearby residence’s property line and actual residence, the onsite Emergency Backup Generator and HVAC systems are within El Dorado County’s noise level standards according to El Dorado County Title 130 Zoning and Noise Ordinance, Chapter 130.37 – Noise Standards.

**Table 1 – Eldorado County Table 130.37.060.1  
Noise Level Performance Standards for Noise Sensitive Land Uses  
Affected by Non-Transportation Sources**

Noise Level Descriptor	Daytime 7 a.m. – 7 p.m.		Evening 7 p.m. – 10 p.m.		Night 10 p.m. – 7 a.m.	
	Community / Rural Centers	Rural Regions	Community / Rural Centers	Rural Regions	Community / Rural Centers	Rural Regions
Hourly Leq, dBA	55	50	50	45	45	40
Maximum Level, dBA	70	60	60	55	55	50



## Radio Frequency Emissions Compliance Report For AT&T Mobility

<b>Site Name:</b>	Zee Estates	<b>Site Structure Type:</b>	Monopine
<b>Address:</b>	Gate Lane 1,000' South East of the intersection of Gate Lane and Salmon Falls Road Pilot Hill, CA	<b>Latitude:</b>	38.810023
<b>Report Date:</b>	July 17, 2017	<b>Longitude:</b>	-121.020325
		<b>Project:</b>	New Build

### General Summary

AT&T Mobility has contracted Waterford Consultants, LLC to conduct a Radio Frequency Electromagnetic Compliance assessment of the proposed Zee Estates site located at Gate Lane 1,000' South East of the intersection of Gate Lane and Salmon Falls Road, Pilot Hill, CA. This report contains information about the radio telecommunications equipment to be installed at this site and the surrounding environment with regard to RF Hazard compliance. This assessment is based on installation designs and operational parameters provided by AT&T Mobility.

The compliance framework is derived from the Federal Communications Commission (FCC) Rules and Regulations for preventing human exposure in excess of the applicable Maximum Permissible Exposure ("MPE") limits. At any location at this site, the power density resulting from each transmitter may be expressed as a percentage of the frequency-specific limits and added to determine if 100% of the exposure limit has been exceeded. The FCC Rules define two tiers of permissible exposure differentiated by the situation in which the exposure takes place and/or the status of the individuals who are subject to exposure. General Population / Uncontrolled exposure limits apply to those situations in which persons may not be aware of the presence of electromagnetic energy, where exposure is not employment-related, or where persons cannot exercise control over their exposure. Occupational / Controlled exposure limits apply to situations in which persons are exposed as a consequence of their employment, have been made fully aware of the potential for exposure, and can exercise control over their exposure.

Frequency (MHz)	<i>Limits for General Population/ Uncontrolled Exposure</i>		<i>Limits for Occupational/ Controlled Exposure</i>	
	Power Density (mW/cm <sup>2</sup> )	Averaging Time (minutes)	Power Density (mW/cm <sup>2</sup> )	Averaging Time (minutes)
30-300	0.2	30	1	6
300-1500	f/1500	30	f/300	6
1500-100,000	1.0	30	5.0	6

f=Frequency (MHz)

In situations where the predicted MPE exceeds the General Population threshold in an accessible area as a result of emissions from multiple transmitters, FCC licensees that contribute greater than 5% of the aggregate MPE share responsibility for mitigation.

Based on the computational guidelines set forth in FCC OET Bulletin 65, Waterford Consultants, LLC has developed software to predict the overall Maximum Permissible Exposure possible at any particular location given the spatial orientation and operating parameters of multiple RF sources. These theoretical results represent worst-case predictions as emitters are assumed to be operating at 100% duty cycle.

## Attachment 6 Site 6 Zee Estates

For any area in excess of 100% General Population MPE, access controls with appropriate RF alerting signage must be put in place and maintained to restrict access to authorized personnel. Signage must be posted to be visible upon approach from any direction to provide notification of potential conditions within these areas. Subject to other site security requirements, occupational personnel should be trained in RF safety and equipped with personal protective equipment (e.g. RF personal monitor) designed for safe work in the vicinity of RF emitters. Controls such as physical barriers to entry imposed by locked doors, hatches and ladders or other access control mechanisms may be supplemented by alarms that alert the individual and notify site management of a breach in access control. Waterford Consultants, LLC recommends that any work activity in these designated areas or in front of any transmitting antennas be coordinated with all wireless tenants.

## **Analysis**

AT&T Mobility proposes the following installation at this location:

- Install twelve (12) new panel antennas
- Install six (6) new RRUS-11, three (3) RRUS-12, twelve (12) RRUS-32

The antennas will be mounted on a 160-foot Monopine with centerlines at 150 and 140 feet above ground level. The antennas will be oriented toward 90, 330 and 210 degrees. The Effective Radiated Power (ERP) in any direction from all AT&T Mobility operations will not exceed 26,556 Watts. Other appurtenances such as RRUs and hybrid cable are not sources of RF emissions. From this site, AT&T Mobility will enhance voice and data services to surrounding areas in licensed 700, 850, 1900, 2100 and 2300 MHz bands. No other antennas are known to be operating in the vicinity of this site.

Power density decreases significantly with distance from any antenna. The panel-type antennas to be employed at this site are highly directional by design and the orientation in azimuth and mounting elevation, as documented, serve to reduce the potential to exceed MPE limits at any location other than directly in front of the antennas. For accessible areas at ground level, the maximum predicted power density level resulting from all AT&T Mobility operations is 0.4105% of the FCC General Population limits (0.0821% of the FCC Occupational limits). Incident at adjacent buildings depicted in Figure 1, the maximum predicted power density level resulting from all AT&T Mobility operations is 0.7055% of the FCC General Population limits (0.1411% of the FCC Occupational limits). The proposed operation will not expose members of the General Public to hazardous levels of RF energy and will not contribute to existing cumulative MPE levels on walkable surfaces at ground or at adjacent buildings by 5% of the General Population limits.

Waterford Consultants, LLC recommends posting contact information signage at the gate that informs personnel entering the site of basic precautions to be followed when working around antennas. RF alerting signage (Caution) should be posted at the base of the proposed Monopine to inform authorized climbers of potential conditions near the antennas. These recommendations are depicted in Figure 2.

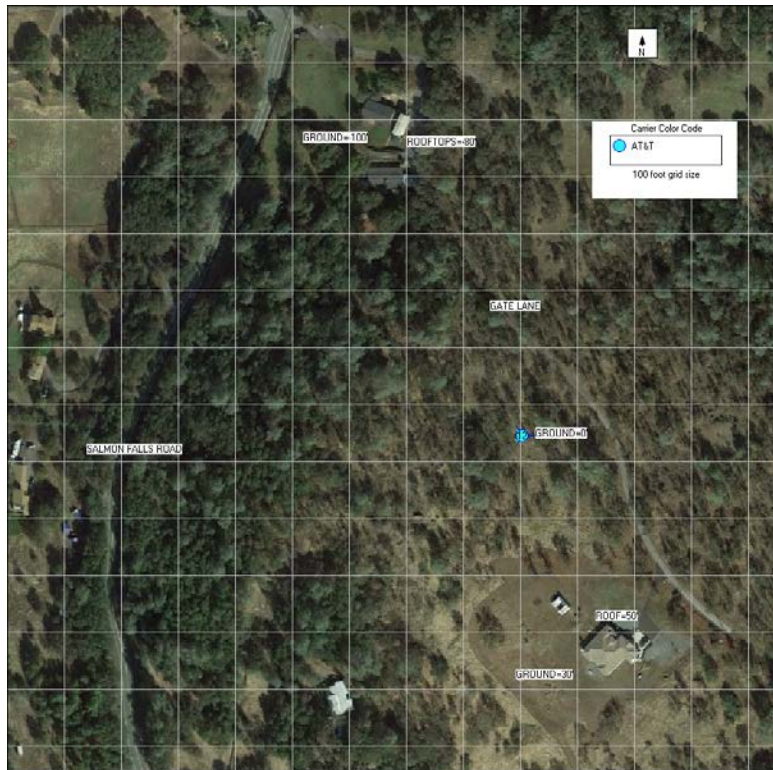

Figure 1: Antenna Locations

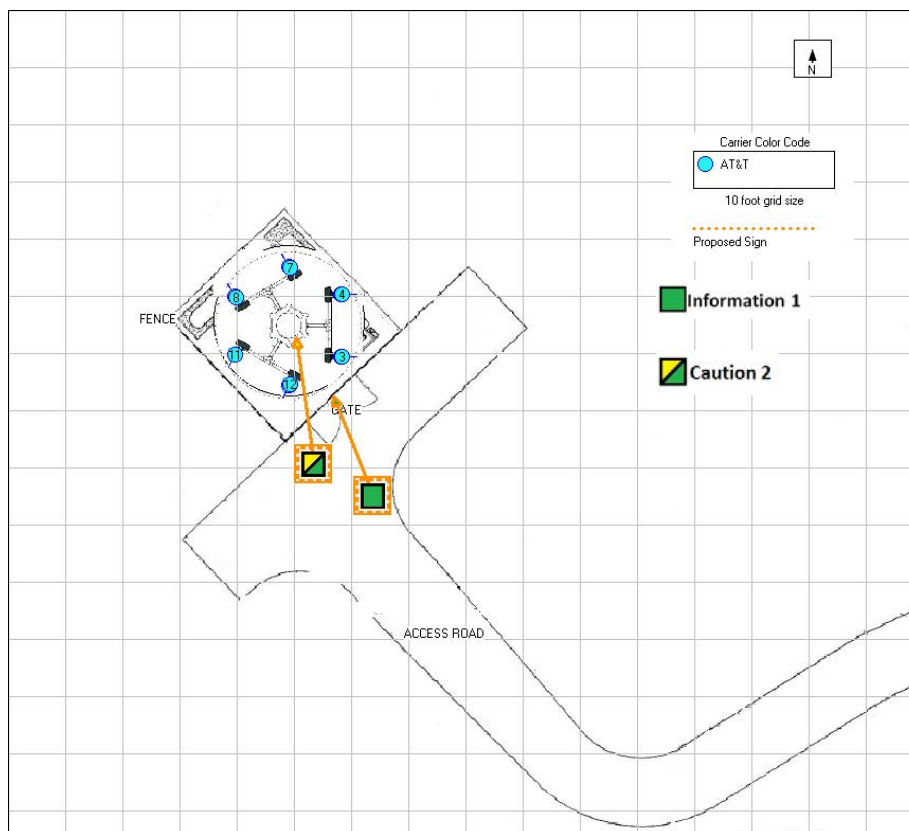

Figure 2: Mitigation Recommendations

### **Compliance Statement**

Based on information provided by AT&T Mobility and predictive modeling, the installation proposed by AT&T Mobility at Gate Lane 1,000' South East of the intersection of Gate Lane and Salmon Falls Road, Pilot Hill, CA will be compliant with Radiofrequency Radiation Exposure Limits of 47 C.F.R. § 1.1307(b)(3) and 1.1310. RF alerting signage and restricting access to the Monopine to authorized climbers that have completed RF safety training is required for Occupational environment compliance.

### **Certification**

I, David H. Kiser, am the reviewer and approver of this report and am fully aware of and familiar with the Rules and Regulations of both the Federal Communications Commissions (FCC) and the Occupational Safety and Health Administration (OSHA) with regard to Human Exposure to Radio Frequency Radiation, specifically in accordance with FCC's OET Bulletin 65. I have reviewed this Radio Frequency Exposure Assessment report and believe it to be both true and accurate to the best of my knowledge.

