

TM-F20-0006 EXHIBIT A - LOCATION MAP

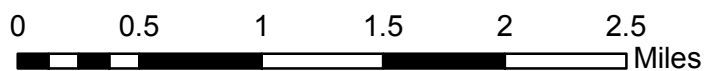

TM-F20-0006

EXHIBIT B - VICINITY MAP

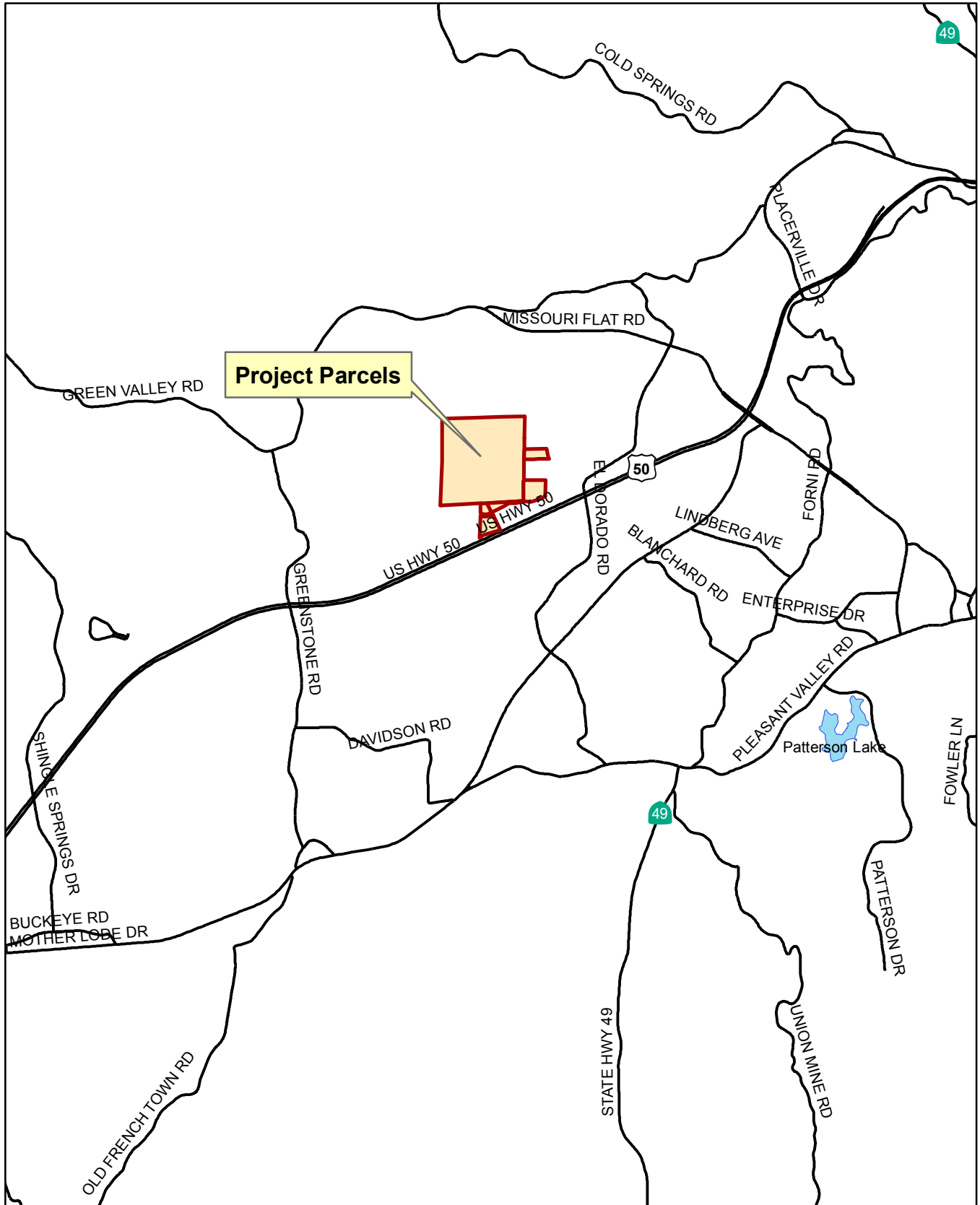
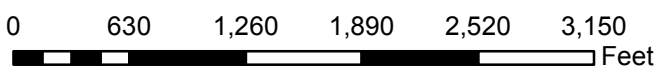
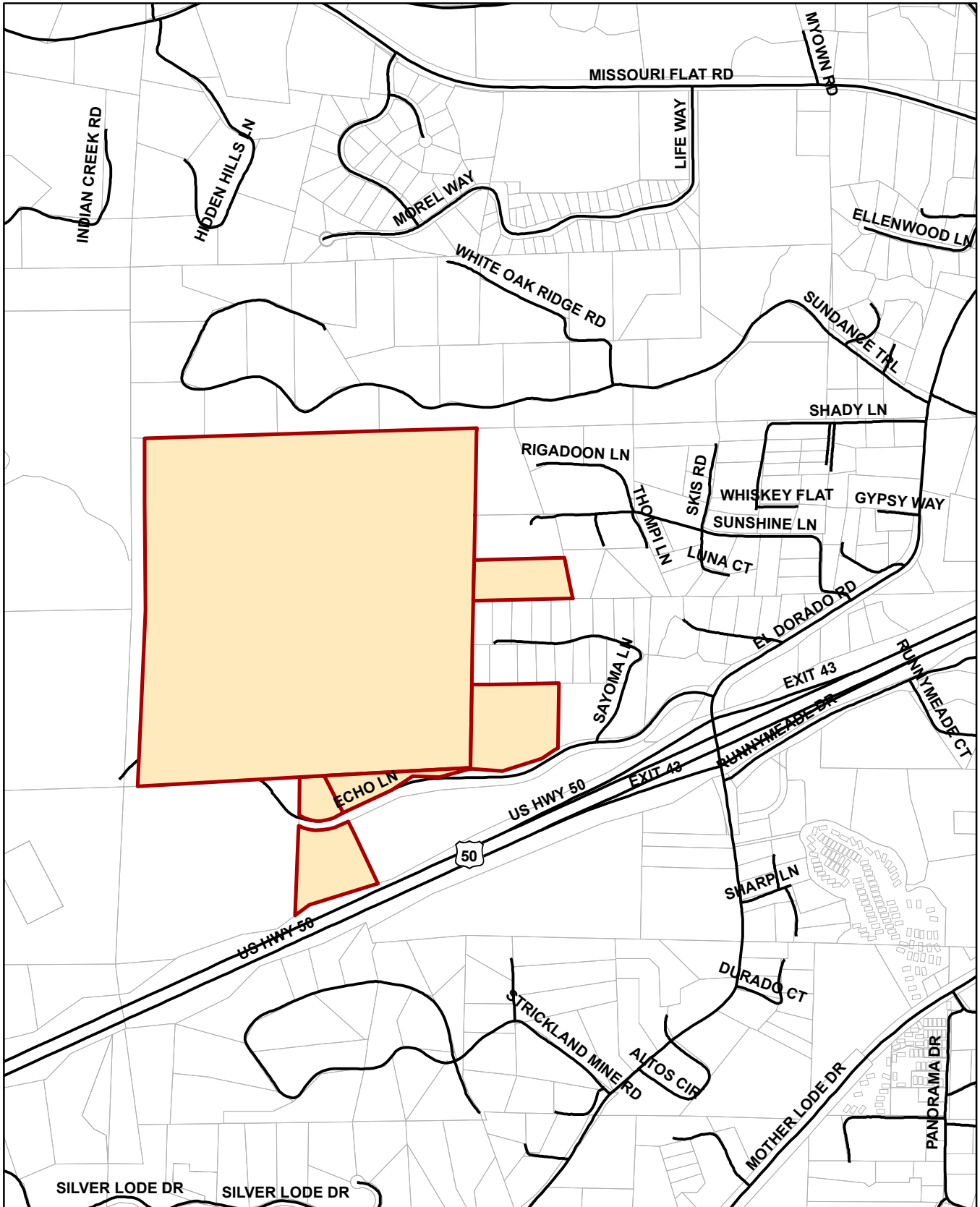

TM-F20-0006

EXHIBIT C - SITE AERIAL PHOTO

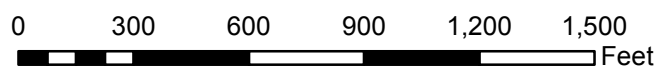

2020 JUL 29 PM 3:43

RECEIVED
PLANNING DEPARTMENT

POR'S. W. 1/2 SEC'S. 22 & 27, T.10N, R.10E, M.D.M.

Tax Area Code

327.08

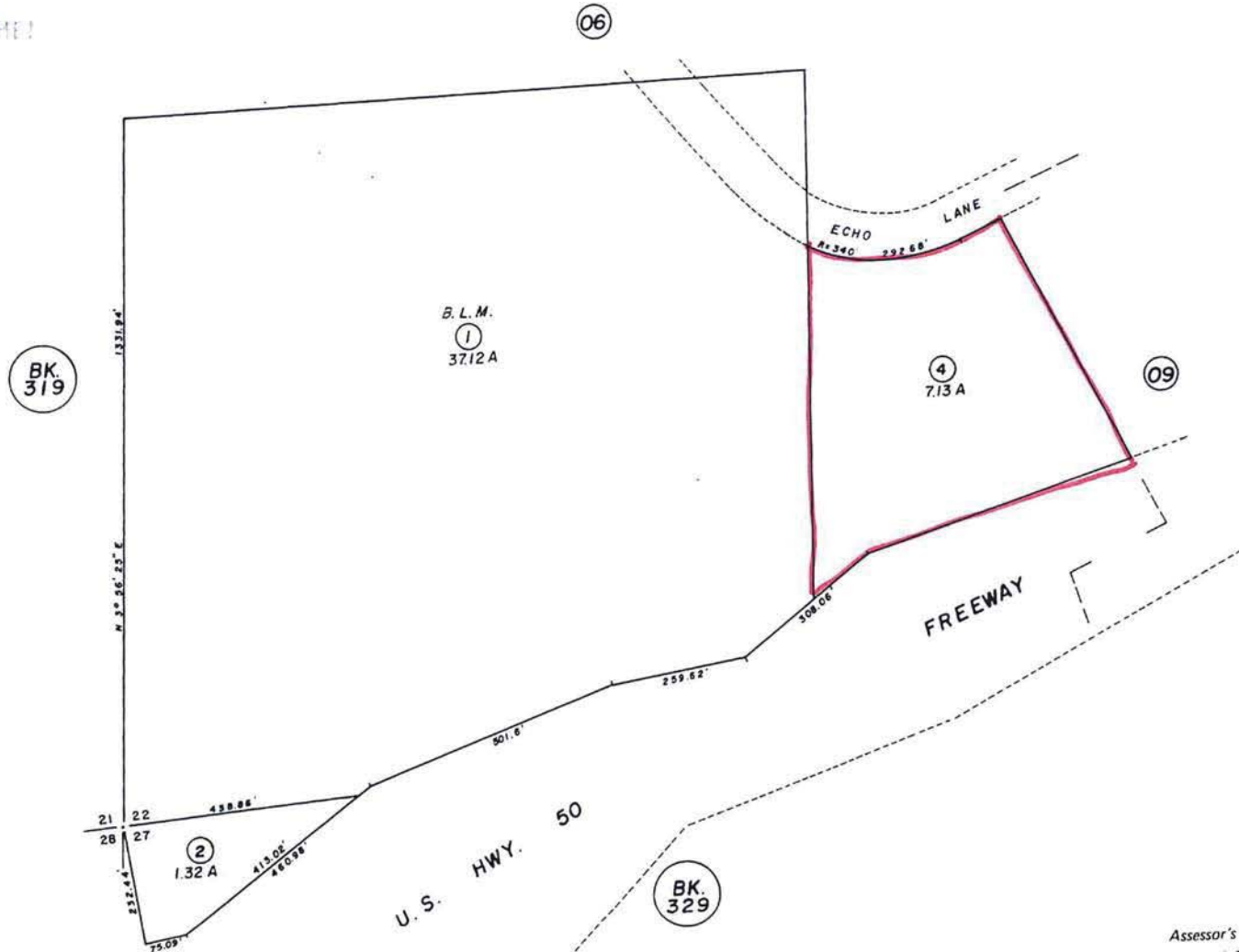

NOTE - Assessor's Block Numbers Shown in Ellipses
Assessor's Parcel Numbers Shown in Circles

Assessor's Map Bk. 327 - Pg. 08
County of El Dorado, California

TM-E20-0006
241563 4 of 44

POR. S1/2 SEC. 22, T.10N., R.10E., M.D.M.

Bk 327 Pg 02

Bk 327 Pg 04

327:06

2020 JUL 29 PM 3:43
RECEIVED
PLANNING DEPARTMENT



Bk 319
Pg 06

Bk 327 Pg 05

8

6.05 A

PM 50.51/1
10
146.7 A

PM 50.51/2
11
5.01 A

CNTR
SEC. 22

SAYONA LN

Bk 327
Pg 07

Bk 319 Pg 07

PM 50.51/3
12
9.09 A

US HWY

Bk 327
Pg 08

Acreages Are Estimates

3
1.87 A

4
2.5 A

Adjacent Map Pages Shown in Grey Text
Assessor's Block Numbers Shown in Ellipses
Assessor's Parcel Numbers Shown in Circles

Bk 327 Pg 09

Rev. Nov. 5, 2008

Assessor's Map Bk. 327, Pg. 06
County of El Dorado, CA

THIS MAP IS NOT A SURVEY. It is prepared by the El Dorado Co Assessor's office for assessment purposes only. Area calculations and characteristics are not guaranteed. Users should verify them such as dimensions and acreage.

PFF:km
Echo Lane Rez
02/03/09



ORDINANCE NO. 4809

**THE BOARD OF SUPERVISORS OF THE COUNTY OF EL DORADO DOES
ORDAIN AS FOLLOWS:**

RELATED TO REZONING IN THE PLACERVILLE AREA
PETITIONED BY ECHO LANE INVESTORS, LLC

Section 1. The Official Zoning Map for the Placerville Area is hereby amended to rezone the following described lands from Agriculture (A) zone to Estate Residential Five-Acre-Planned Development (RE-5-PD) and Open Space-Planned Development (OS-PD) zone:

Placerville Area

Assessor's Parcel Nos. 327-060-03, -04, and 327-020-10, being described as a portion of Section 22, Township 10 North, Range 10 East, M.D.M., consisting of 150.47 acres

Section 2. The Official Zoning Map for the Placerville Area is hereby amended to rezone the following described lands from Agricultural (A) zone to Open Space-Planned Development (OS-0PD) zone:

Placerville Area

Assessor's Parcel No. 327-060-08, being described as a portion of Section 22, Township 10 North, Range 10 East, M.D.M., consisting of 6.05 acres

Section 3. The Official Zoning Map for the Placerville Area is hereby amended to rezone the following described lands from Single-Family Three-Acre Residential (R3A) zone to Open Space-Planned Development (OS-PD) zone:

Placerville Area

Assessor's Parcel Nos. 327-060-11, being described as a portion of Section 22, Township 10 North, Range 10 East, M.D.M., consisting of 5.01 acres

Section 4. The Official Zoning Map for the Placerville Area is hereby amended to rezone the following described lands from Estate Residential Five-Acre (RE-5) zone to Estate Residential Five-Acre-Planned Development (RE-5-PD) zone:

Placerville Area

Assessor's Parcel No. 327-020-10, being described as Section 22, Township 10 North, Range 10 East, M.D.M., consisting of 5.02 acres

Section 5. The Official Zoning Map for the Placerville Area is hereby amended to rezone the following described lands from Single-Family three-Acre Residential (R3A) zone to Single-Family Three-Acre Residential-Planned Development (R3A-PD) and Open Space-Planned Development (OS-PD) zone:

Placerville Area

Assessor's Parcel No. 327-060-12, being described as a portion of Section 22, Township 10 North, Range 10 East, M.D.M., consisting of 9.09 acres

Section 6. The Official Zoning Map for the Placerville Area is hereby amended to rezone the following described lands from Agriculture (A) zone to Single-Family Three-Acre Residential (R3A) zone:

Placerville Area

Assessor's Parcel No. 327-080-04, being described as Section 22, Township 10 North, Range 10 East, M.D.M., consisting of 7.13 acres

Ordinance No. 4809

Page 3

Section 7. This ordinance shall take effect and shall become effective thirty (30) days following the adoption hereof.

PASSED AND ADOPTED by the Board of Supervisors of the County of El Dorado at a regular meeting of said Board, held on the 3 day of February, 2009, by the following vote of said Board:

Ayes: Ron Briggs, James R. Sweeney, John Knight
Raymond Nutting, Norma Santiago

ATTEST
SUZANNE ALLEN DE SANCHEZ
Clerk of the Board of Supervisors

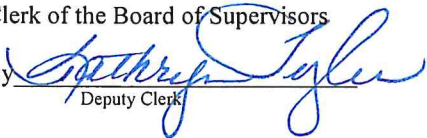
By 
Deputy Clerk

Noes: none
Absent: none

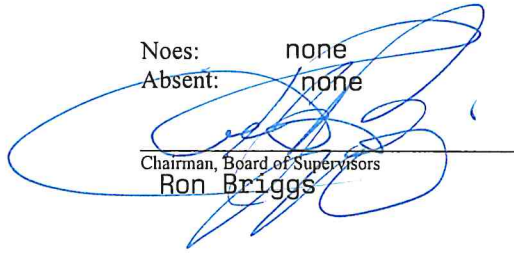

Chairman, Board of Supervisors
Ron Briggs

I CERTIFY THAT:
THE FOREGOING INSTRUMENT IS A CORRECT COPY OF THE ORIGINAL ON FILE IN THIS OFFICE

Date _____
ATTEST: SUZANNE ALLEN DE SANCHEZ, Clerk of the Board of Supervisors
of the County of El Dorado, State of California.

By _____
Deputy Clerk

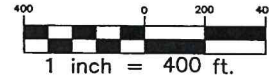
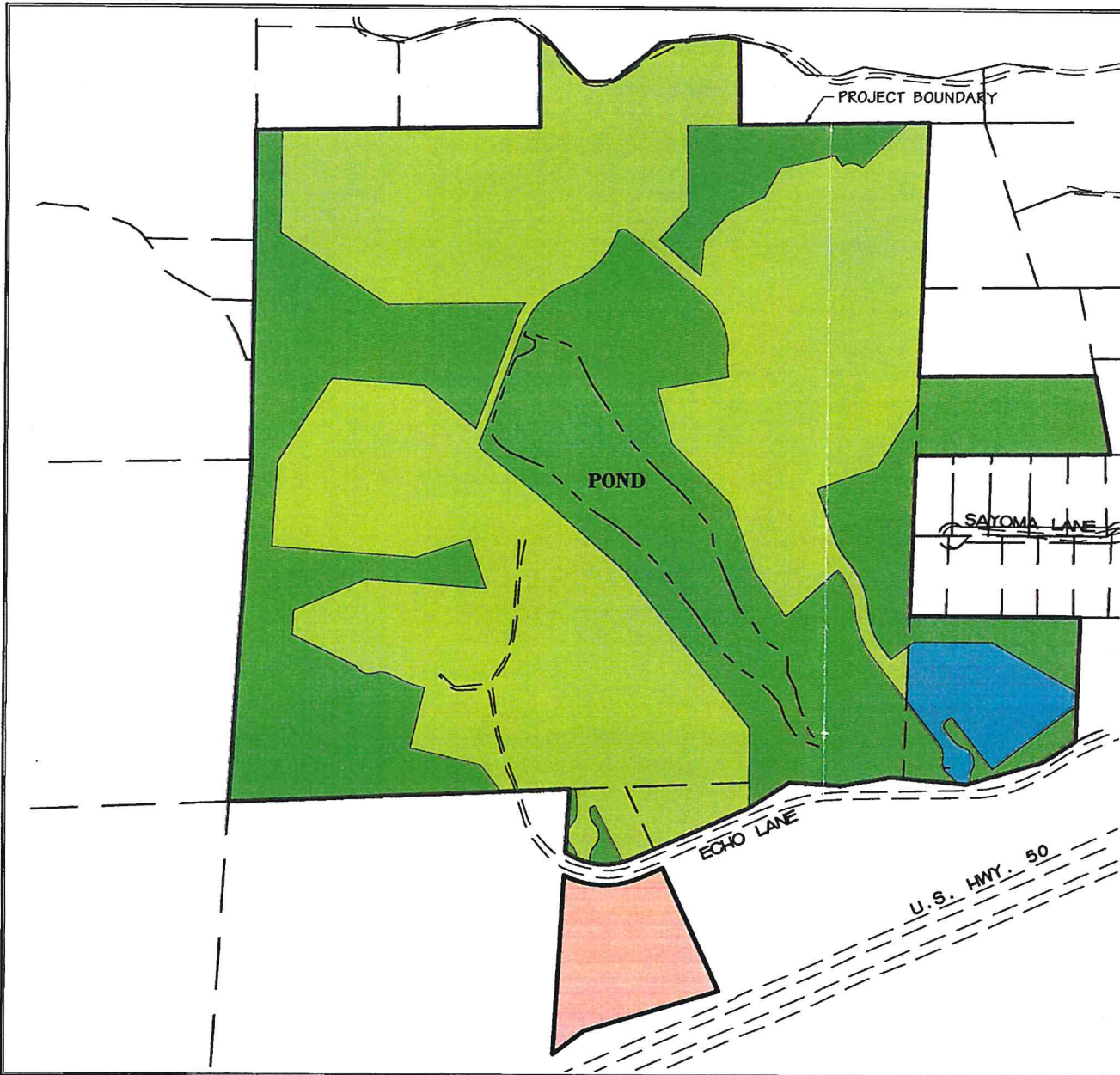
10dec2008 11:35am 5391_Zoning Exhibit-proposed



Legend

- PROPOSED ZONING: OS-PD
- PROPOSED ZONING: RE-5-PD
- PROPOSED ZONING: R3-A-PD
- PROPOSED ZONING: R3-A

TEAM DESIGN SOLUTIONS FOR THE BEST DEVELOPMENT



CARLTON
Engineering Inc.
3083 Piedmont Road, Shingle Springs, CA 95682
Voice 530.677.3515 Fax 530.677.6645

Indian Creek Ranch

PROPOSED ZONING EXHIBIT

Project Location:
Echo Lane
Diamond Springs, CA 95619
El Dorado County

DESIGN	DRAWN	RELEASE DATE
ACR	ASR	04/20/2008
Hz SCALE	PROJECT	
1"=400'	5391-05-08	
CHECKED BY & DATE		

FIGURE
X2

EXHIBIT A

LARGE LOT FINAL MAP OF
INDIAN CREEK RANCH

OWNER'S STATEMENT

THE UNDERSIGNED OWNER OF RECORD TITLE INTEREST HEREBY CONSENTS TO THE PREPARATION AND FILING OF THIS MAP.

THE UNDERSIGNED FURTHER MAKES AN IRREVOCABLE OFFER OF DEDICATION, PURSUANT TO THE PROVISIONS OF SECTION 7050 OF THE GOVERNMENT CODE, TO THE COUNTY OF EL DORADO, FOR ANY AND ALL PUBLIC PURPOSES, THE RIGHT OF WAY ON, OVER, ACROSS AND UNDER THOSE STRIPS OF LAND SHOWN HEREON AND DESIGNATED AS "IRREVOCABLE OFFER OF DEDICATION", SAID OFFER SHALL REMAIN IN PERPETUITY DESPITE A REJECTION OF SUCH OFFER BY THE APPLICABLE PUBLIC ENTITY.

ECHO LANE INVESTORS, LLC
A CALIFORNIA LIMITED LIABILITY COMPANY

BY: _____
NAME: _____
TITLE: _____

NOTARY ACKNOWLEDGMENT

A NOTARY PUBLIC OR OTHER OFFICER COMPLETING THIS CERTIFICATE VERIFIES ONLY THE IDENTITY OF THE INDIVIDUAL WHO SIGNED THE DOCUMENT TO WHICH THIS CERTIFICATE IS ATTACHED, AND NOT THE TRUTHFULNESS, ACCURACY, OR VALIDITY OF THAT DOCUMENT.

STATE OF CALIFORNIA)
) SS
COUNTY OF _____)
ON _____, BEFORE ME, _____, A
NOTARY PUBLIC,

PERSONALLY APPEARED _____, WHO PROVED TO ME ON THE BASIS OF SATISFACTORY EVIDENCE, TO BE THE PERSON WHOSE NAME IS SUBSCRIBED TO THE WITHIN INSTRUMENT AND ACKNOWLEDGED TO ME THAT HE EXECUTED THE SAME IN HIS AUTHORIZED CAPACITIES, AND THAT BY HIS SIGNATURES ON THE INSTRUMENT THE PERSON, OR THE ENTITY UPON BEHALF OF WHICH THE PERSON ACTED, EXECUTED THE INSTRUMENT.

I CERTIFY UNDER PENALTY OF PERJURY UNDER THE LAWS OF THE STATE OF CALIFORNIA THAT THE FOREGOING PARAGRAPH IS TRUE AND CORRECT.

WITNESS MY HAND.

PRINCIPLE COUNTY OF BUSINESS _____
COMMISSION NO: _____
NAME _____ COMMISSION EXPIRES: _____

TRUSTEE'S STATEMENT

THE UNDERSIGNED AS TRUSTEE UNDER DEED OF TRUST, RECORDED MAY 7, 2008, AS INSTRUMENT NO. 2008-0021805, OFFICIAL RECORDS OF EL DORADO COUNTY, HEREBY CONSENT TO THE PREPARATION AND FILING OF THIS MAP.

AMERICAN SECURITIES COMPANY

NAME _____
TITLE _____

NOTARY ACKNOWLEDGMENT

A NOTARY PUBLIC OR OTHER OFFICER COMPLETING THIS CERTIFICATE VERIFIES ONLY THE IDENTITY OF THE INDIVIDUAL WHO SIGNED THE DOCUMENT TO WHICH THIS CERTIFICATE IS ATTACHED, AND NOT THE TRUTHFULNESS, ACCURACY, OR VALIDITY OF THAT DOCUMENT.

STATE OF CALIFORNIA)
) SS
COUNTY OF _____)
ON _____, BEFORE ME, _____, A
NOTARY PUBLIC,

PERSONALLY APPEARED _____, WHO PROVED TO ME ON THE BASIS OF SATISFACTORY EVIDENCE, TO BE THE PERSON WHOSE NAME IS SUBSCRIBED TO THE WITHIN INSTRUMENT AND ACKNOWLEDGED TO ME THAT HE EXECUTED THE SAME IN HIS AUTHORIZED CAPACITIES, AND THAT BY HIS SIGNATURES ON THE INSTRUMENT THE PERSON, OR THE ENTITY UPON BEHALF OF WHICH THE PERSON ACTED, EXECUTED THE INSTRUMENT.

I CERTIFY UNDER PENALTY OF PERJURY UNDER THE LAWS OF THE STATE OF CALIFORNIA THAT THE FOREGOING PARAGRAPH IS TRUE AND CORRECT.

WITNESS MY HAND.

PRINCIPLE COUNTY OF BUSINESS _____
COMMISSION NO: _____
NAME _____ COMMISSION EXPIRES: _____

TRUSTEE'S STATEMENT

THE UNDERSIGNED AS TRUSTEE UNDER DEED OF TRUST, RECORDED OCTOBER 15, 2008, AS INSTRUMENT NO. 2008-0052984, OFFICIAL RECORDS OF EL DORADO COUNTY, HEREBY CONSENT TO THE PREPARATION AND FILING OF THIS MAP.

PLACER TITLE COMPANY

NAME _____
TITLE _____

NOTARY ACKNOWLEDGMENT

A NOTARY PUBLIC OR OTHER OFFICER COMPLETING THIS CERTIFICATE VERIFIES ONLY THE IDENTITY OF THE INDIVIDUAL WHO SIGNED THE DOCUMENT TO WHICH THIS CERTIFICATE IS ATTACHED, AND NOT THE TRUTHFULNESS, ACCURACY, OR VALIDITY OF THAT DOCUMENT.

STATE OF CALIFORNIA)
) SS
COUNTY OF _____)
ON _____, BEFORE ME, _____, A
NOTARY PUBLIC,

PERSONALLY APPEARED _____, WHO PROVED TO ME ON THE BASIS OF SATISFACTORY EVIDENCE, TO BE THE PERSON WHOSE NAME IS SUBSCRIBED TO THE WITHIN INSTRUMENT AND ACKNOWLEDGED TO ME THAT HE EXECUTED THE SAME IN HIS AUTHORIZED CAPACITIES, AND THAT BY HIS SIGNATURES ON THE INSTRUMENT THE PERSON, OR THE ENTITY UPON BEHALF OF WHICH THE PERSON ACTED, EXECUTED THE INSTRUMENT.

I CERTIFY UNDER PENALTY OF PERJURY UNDER THE LAWS OF THE STATE OF CALIFORNIA THAT THE FOREGOING PARAGRAPH IS TRUE AND CORRECT.

WITNESS MY HAND.

PRINCIPLE COUNTY OF BUSINESS _____
COMMISSION NO: _____
NAME _____ COMMISSION EXPIRES: _____

PARCELS 1, 2 & 3 OF PARCEL MAP BK. 50, PG. 51 AND
PORTIONS OF SECTION 22, T. 10 N., R. 10 E., M.D.M.
COUNTY OF EL DORADO STATE OF CALIFORNIA
SCALE: NA SHEET 1 OF 8 JANUARY, 2021



SURVEYOR'S STATEMENT

THIS MAP WAS PREPARED BY ME OR UNDER MY DIRECTION, THE SURVEY IS TRUE AND COMPLETE AND IS BASED UPON A FIELD SURVEY IN CONFORMANCE WITH THE REQUIREMENTS OF THE SUBDIVISION MAP ACT AND LOCAL ORDINANCES AT THE REQUEST OF ECHO LANE INVESTORS, LLC IN JANUARY, 2020. I HEREBY STATE THAT THIS FINAL MAP SUBSTANTIALLY CONFORMS TO THE CONDITIONALLY APPROVED TENTATIVE MAP AND THAT THE MONUMENTS WILL BE OF THE CHARACTER AND WILL BE SET BY DECEMBER, 2020 THAT SAID MONUMENTS WILL BE SUFFICIENT TO ENABLE THE SURVEY TO BE RETRACED.

DATE: _____

KEVIN A. HEENEY LS 5914



PLANNING AND BUILDING DIRECTOR'S STATEMENT

I, TIFFANY SCHMID, HEREBY STATE THAT THIS FINAL MAP CONFORMS SUBSTANTIALLY TO THE TENTATIVE MAP OF THIS SUBDIVISION APPROVED ON FEBRUARY 3, 2009 BY THE BOARD OF SUPERVISORS AND ANY APPROVED ALTERATIONS THEREOF AND THAT ALL CONDITIONS IMPOSED UPON SAID APPROVALS HAVE BEEN SATISFIED.

DATE: _____

BY: _____
TIFFANY SCHMID
DIRECTOR, PLANNING & BUILDING DEPARTMENT
COUNTY OF EL DORADO, CALIFORNIA
PRINCIPAL PLANNER
COUNTY OF EL DORADO, CALIFORNIA

COUNTY ENGINEER'S STATEMENT

I, ANDREW S. GABER, THE UNDERSIGNED, HEREBY STATE THAT THERE ARE NO IMPROVEMENTS REQUIRED AT THIS TIME, AND THAT THE ROADS SHOWN HEREON SHALL BE CONSTRUCTED WITH THE FILING OF EACH SUBSEQUENT FINAL MAP.

DATE: _____

ANDREW S. GABER, RCE 45187
COUNTY ENGINEER
COMMUNITY DEVELOPMENT AGENCY
TRANSPORTATION DIVISION
COUNTY OF EL DORADO, CALIFORNIA

COUNTY SURVEYOR'S STATEMENT

I HAVE EXAMINED THE MAP, THE SUBDIVISION AS SHOWN IS SUBSTANTIALLY THE SAME AS IT APPEARED ON THE TENTATIVE MAP, IF REQUIRED, AND ANY APPROVED ALTERATIONS THEREOF. ALL PROVISIONS OF CHAPTER 2 OF THE SUBDIVISION MAP ACT AND OF ANY LOCAL ORDINANCES APPLICABLE AT THE TIME OF APPROVAL OF THE TENTATIVE MAP, IF REQUIRED, HAVE BEEN COMPLIED WITH. I AM SATISFIED THAT THE MAP IS TECHNICALLY CORRECT.

DATE: _____

PHILIP R. MOSBACHER, P.L.S. 7189
COUNTY SURVEYOR
COUNTY OF EL DORADO, CALIFORNIA

BY: _____
BRIAN K. FRAZIER, P.L.S. 9190
DEPUTY SURVEYOR
COUNTY OF EL DORADO, CALIFORNIA

COUNTY TAX COLLECTOR'S STATEMENT

I, K.E. COLEMAN, HEREBY STATE THAT, ACCORDING TO THE RECORDS OF THIS OFFICE, THERE ARE NO LIENS AGAINST THIS SUBDIVISION OR ANY PART THEREOF FOR UNPAID STATE, COUNTY, MUNICIPAL OR LOCAL TAXES OR SPECIAL ASSESSMENTS COLLECTED AS TAXES, EXCEPT TAXES OR SPECIAL ASSESSMENTS NOT YET PAYABLE, PROVIDED THAT THE FINAL MAP IS ACCEPTED FOR RECORD AND FILED PRIOR TO THE NEXT SUCCEEDING LIEN DATE.

DATE: _____

BY: _____
K.E. COLEMAN
TAX COLLECTOR
COUNTY OF EL DORADO, CALIFORNIA
DEPUTY

BOARD CLERK'S STATEMENT

I, JAMES S. MITRISIN, HEREBY STATE THAT THE BOARD OF SUPERVISORS, BY ORDER ON _____, ADOPTED AND APPROVED THIS FINAL MAP OF THIS SUBDIVISION AND HEREBY REJECT THE OFFERS OF DEDICATION TO THE COUNTY OF EL DORADO OF THE STREETS AND OTHER PUBLIC WAYS SHOWN HEREON.

DATE: _____

JAMES S. MITRISIN
CLERK OF THE BOARD OF SUPERVISORS
COUNTY OF EL DORADO, CALIFORNIA

BY: _____
DEPUTY

COUNTY RECORDER'S CERTIFICATE

FILED THIS _____ DAY OF _____, 20____ AT _____:_____, IN BOOK _____, OF MAPS, AT

PAGE _____, DOCUMENT NO. _____, AT THE REQUEST OF ECHO LANE INVESTORS, LLC

TITLE TO THE LAND INCLUDED IN THIS SUBDIVISION IS GUARANTEED BY TITLE CERTIFICATE NO. _____

PREPARED BY PLACER TITLE COMPANY AND IS ON FILE IN THIS OFFICE.

JANELLE K. HORNE
COUNTY RECORDER- CLERK
COUNTY OF EL DORADO, CALIFORNIA

BY: _____
DEPUTY

LARGE LOT FINAL MAP OF INDIAN CREEK RANCH

PARCELS 1, 2 & 3 OF PARCEL MAP BK. 50, PG. 51 AND
PORTIONS OF SECTION 22, T. 10 N., R. 10 E., M.D.M.

COUNTY OF EL DORADO STATE OF CALIFORNIA
SCALE: 1"= 300' SHEET 2 OF 8 JANUARY, 2021



LEGEND

- DIMENSION POINT, NOTHING FOUND OR SET
- ◼ FOUND SECTION CORNER AS NOTED
- ◊ FOUND QUARTER SECTION CORNER AS NOTED
- FOUND MONUMENT AS NOTED
- ⊙ SET 3/4" C.I.P. STAMPED LS 5914
- ⊗ SET 1 1/2" C.I.P. STAMPED LS 5914
- P.U.E. PUBLIC UTILITY EASEMENT
- S.D.E. STORM DRAIN EASEMENT
- (OA) OVERALL

NOTES:

1. THIS SUBDIVISION CONTAINS 177.034 ACRES GROSS, CONSISTING OF 13 LARGE LOTS, AND IS CONSISTENT WITH THE TENTATIVE MAP TM08-1472, APPROVED BY THE BOARD OF SUPERVISORS ON FEBRUARY 3, 2009.
2. ALL DISTANCES ALONG CURVED LINES ARE CHORD DISTANCES.
3. THE ROADS SHOWN HEREON ARE NON-EXCLUSIVE ROAD AND PUBLIC UTILITY EASEMENTS TO BE CONSTRUCTED WITH SUBSEQUENT PHASES AND FINAL MAPS AND ARE SUBJECT TO MODIFICATION WITH SUCH PHASES AND FINAL MAPS.

NOTICE OF RESTRICTION

A NOTICE OF RESTRICTION RECORDED IN DOCUMENT NO. _____ AFFECTS LOTS LL-1 THROUGH LL-13, LIMITING DEVELOPMENT TO PHASING AND FINANCING PURPOSES ONLY.

BASIS OF BEARINGS

THE BASIS OF BEARINGS IS IDENTICAL WITH PM 50-51(TRUE NORTH) BASED ON THE MONUMENTS FOUND IN THE FIELD ALONG THE SOUTH LINE OF PARCEL 1, THE BEARING OF WHICH IS N 87°41'09" E

REFERENCES

1. R.S. 5-51
2. P.M. 10-5
3. P.M. 32-3
4. P.M. 34-119
5. P.M. 40-86
6. P.M. 41-6
7. P.M. 41-28
8. P.M. 41-29
9. P.M. 41-34
10. P.M. 50-51
11. CALTRANS MON. MAP, RTE. 50, P.M. 7.7 TO 15.2 DATED 6-16-1970
12. B.L.A. 07-0020, DOC. #2008-52981
13. R.S. 2-106
14. P.M. 40-148

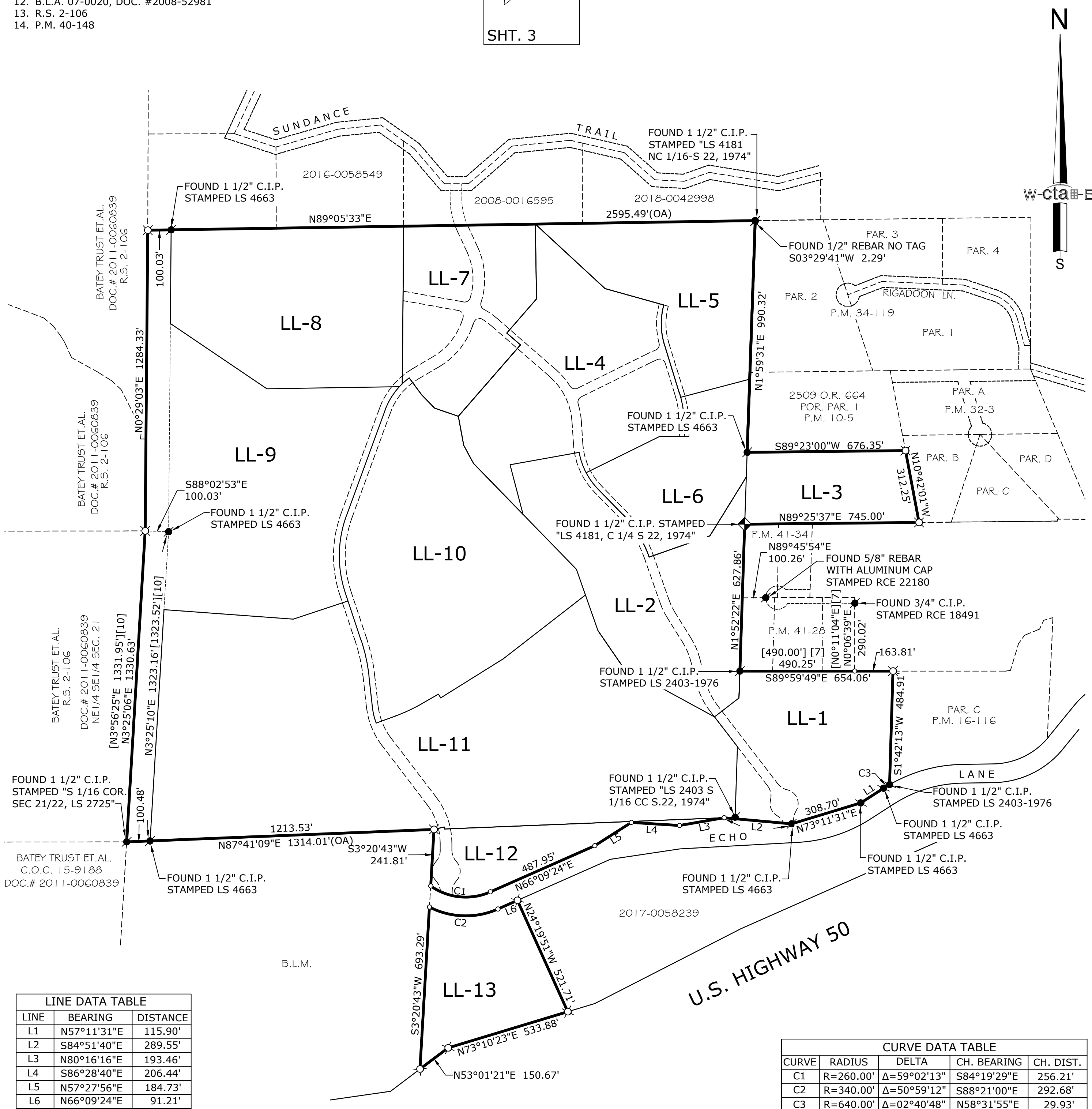
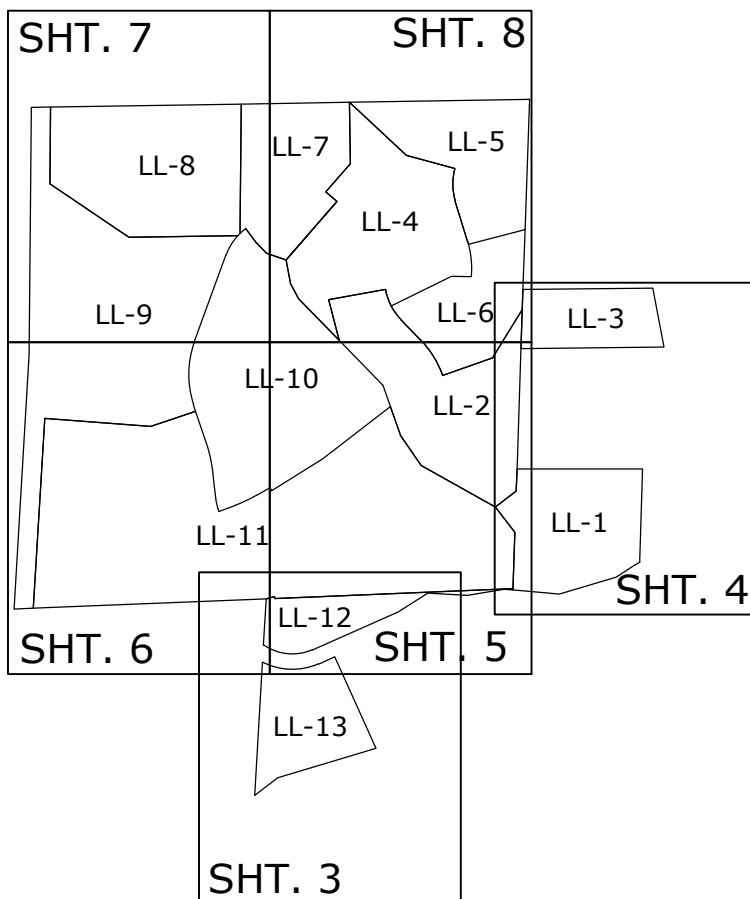

LINE DATA TABLE		
LINE	BEARING	DISTANCE
L1	N57°11'31"E	115.90'
L2	S84°51'40"E	289.55'
L3	N80°16'16"E	193.46'
L4	S86°28'40"E	206.44'
L5	N57°27'56"E	184.73'
L6	N66°09'24"E	91.21'

CURVE DATA TABLE				
CURVE	RADIUS	DELTA	CH. BEARING	CH. DIST.
C1	R=260.00'	Δ=59°02'13"	S84°19'29"E	256.21'
C2	R=340.00'	Δ=50°59'12"	S88°21'00"E	292.68'
C3	R=640.00'	Δ=02°40'48"	N58°31'55"E	29.93'

LARGE LOT FINAL MAP OF INDIAN CREEK RANCH

PARCELS 1, 2 & 3 OF PARCEL MAP BK. 50, PG. 51 AND
PORTIONS OF SECTION 22, T. 10 N., R. 10 E., M.D.M.

COUNTY OF EL DORADO STATE OF CALIFORNIA
SCALE: 1" = 100' SHEET 3 OF 8 JANUARY, 2021

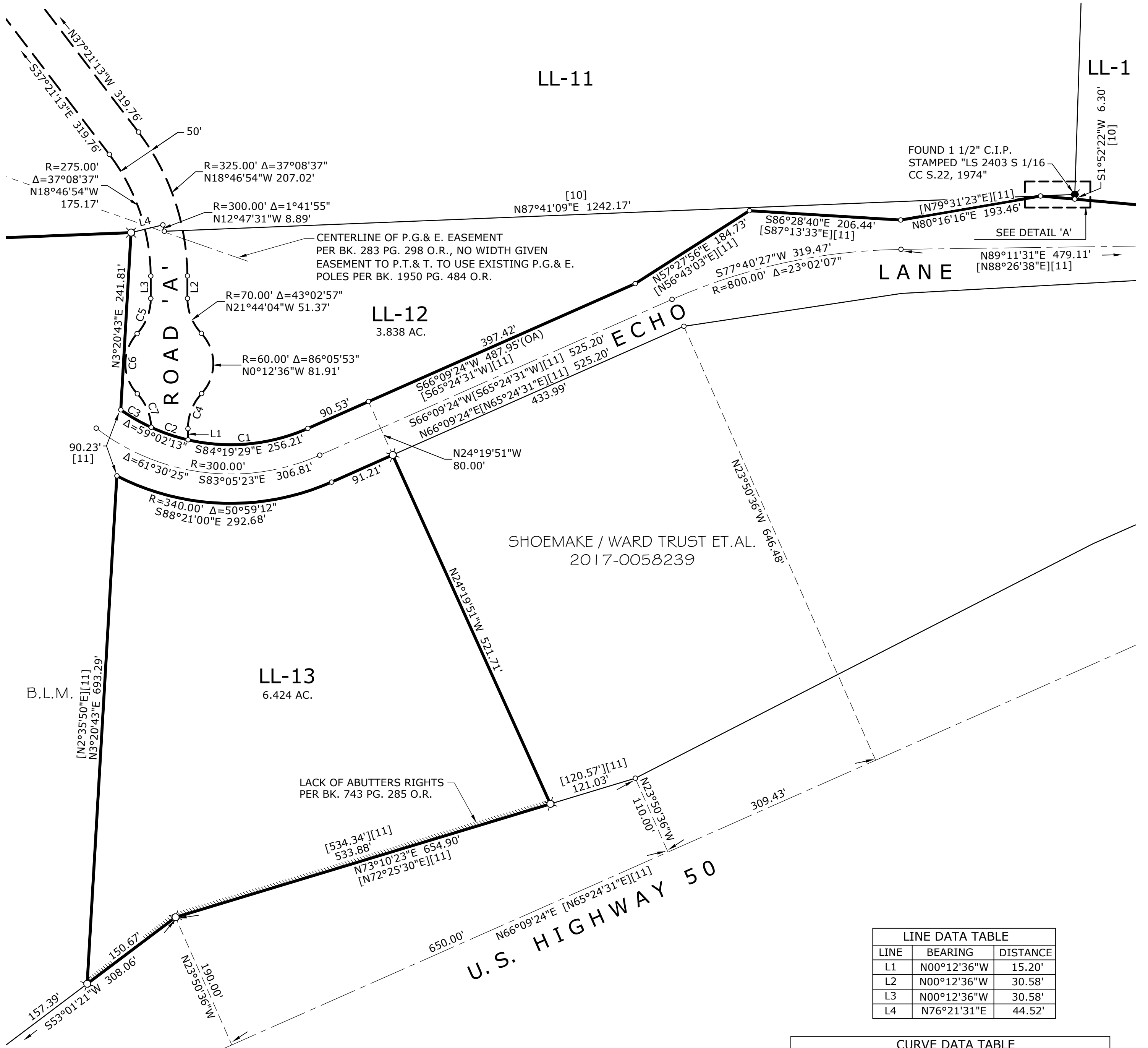
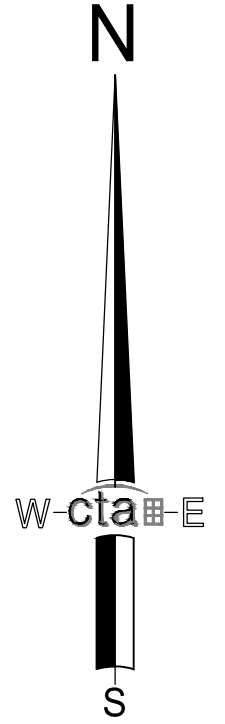
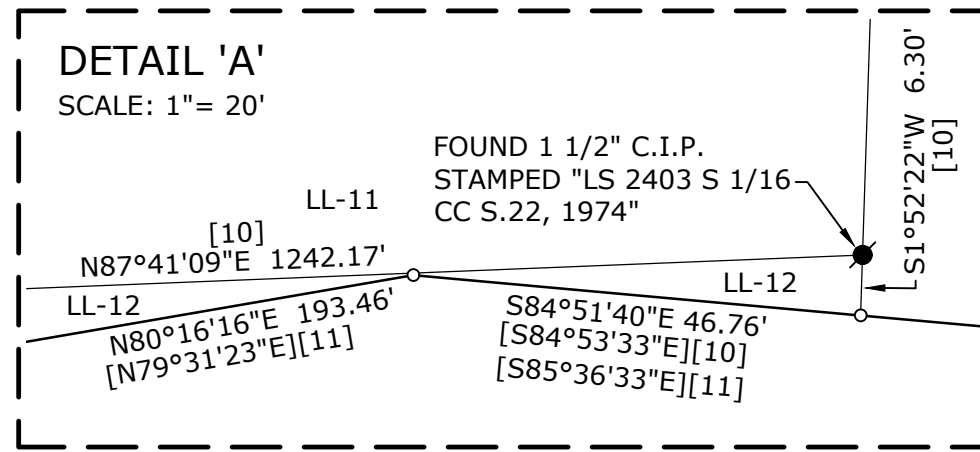
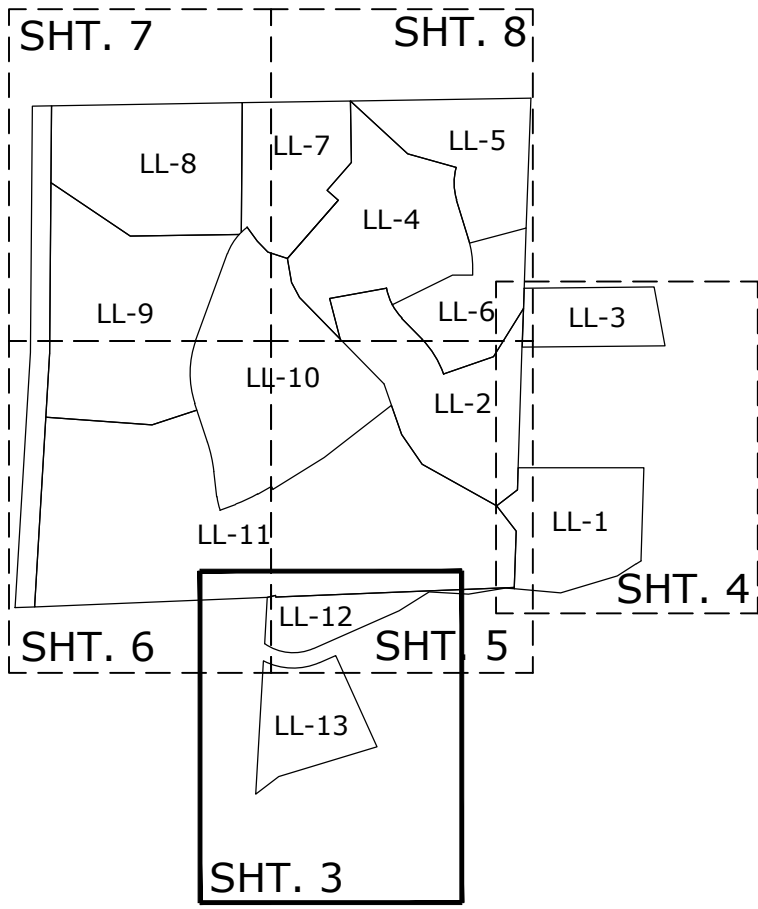

LINE	BEARING	DISTANCE
L1	N00°12'36"W	15.20'
L2	N00°12'36"W	30.58'
L3	N00°12'36"W	30.58'
L4	N76°21'31"E	44.52'

CURVE	RADIUS	DELTA	CH. BEARING	CH. DIST.
C1	R=260.00'	Δ=36°46'36"	N84°32'42"E	164.04'
C2	R=260.00'	Δ=11°40'44"	S71°13'37"E	52.91'
C3	R=260.00'	Δ=10°34'52"	S60°05'49"E	47.95'
C4	R=70.00'	Δ=43°02'57"	S21°18'53"W	51.37'
C5	R=70.00'	Δ=43°02'57"	N21°18'53"E	51.37'
C6	R=60.00'	Δ=86°05'53"	S00°12'36"E	81.91'
C7	R=70.00'	Δ=41°24'22"	N22°33'21"W	49.49'

LARGE LOT FINAL MAP OF INDIAN CREEK RANCH

PARCELS 1, 2 & 3 OF PARCEL MAP BK. 50, PG. 51 AND
PORTIONS OF SECTION 22, T. 10 N., R. 10 E., M.D.M.

COUNTY OF EL DORADO STATE OF CALIFORNIA
SCALE: 1" = 100' SHEET 4 OF 8 JANUARY, 2021

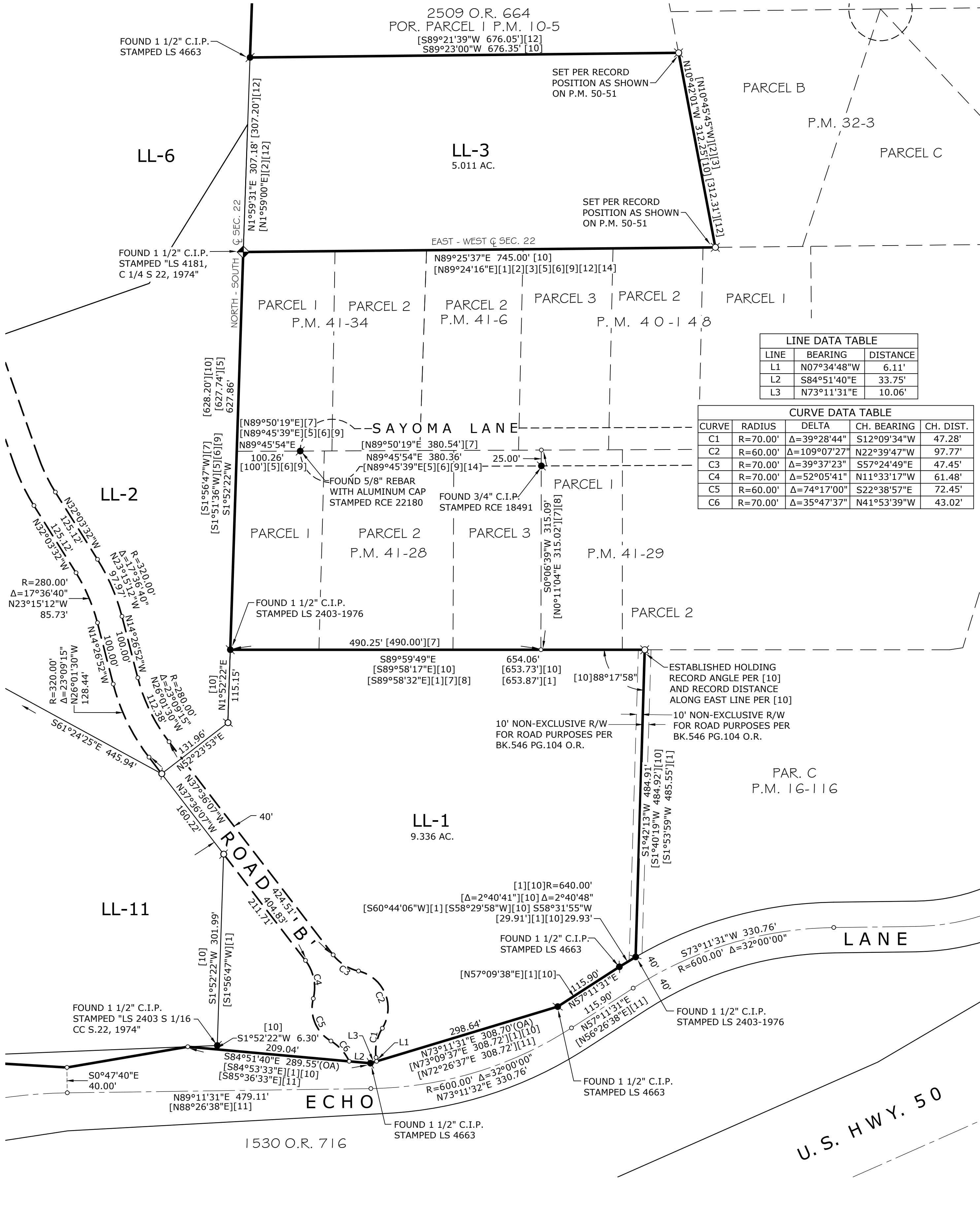
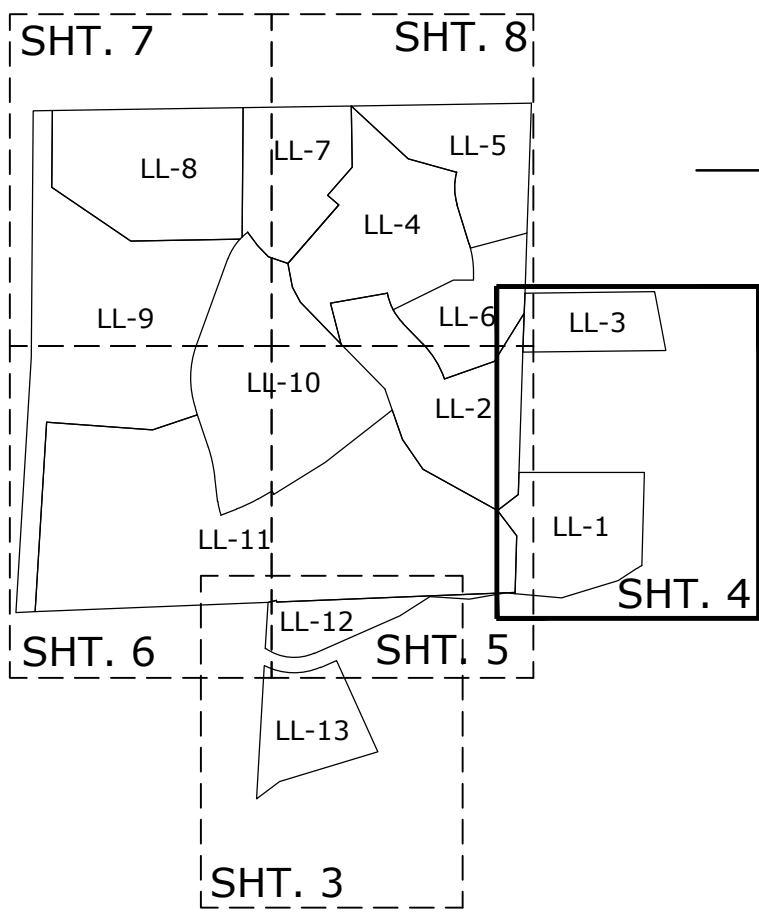
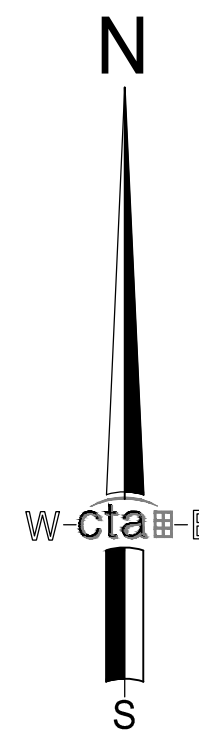

LINE DATA TABLE		
LINE	BEARING	DISTANCE
L1	N07°34'48"W	6.11'
L2	S84°51'40"E	33.75'
L3	N73°11'31"E	10.06'

CURVE DATA TABLE				
CURVE	RADIUS	DELTA	CH. BEARING	CH. DIST.
C1	R=70.00'	Δ=39°28'44"	S12°09'34"W	47.28'
C2	R=60.00'	Δ=109°07'27"	N22°39'47"W	97.77'
C3	R=70.00'	Δ=39°37'23"	S57°24'49"E	47.45'
C4	R=70.00'	Δ=52°05'41"	N11°33'17"W	61.48'
C5	R=60.00'	Δ=74°17'00"	S22°38'57"E	72.45'
C6	R=70.00'	Δ=35°47'37"	N41°53'39"W	43.02'

LARGE LOT FINAL MAP OF INDIAN CREEK RANCH

PARCELS 1, 2 & 3 OF PARCEL MAP BK. 50, PG. 51 AND
PORTIONS OF SECTION 22, T. 10 N., R. 10 E., M.D.M.

COUNTY OF EL DORADO STATE OF CALIFORNIA
SCALE: 1" = 100' SHEET 5 OF 8 JANUARY, 2021

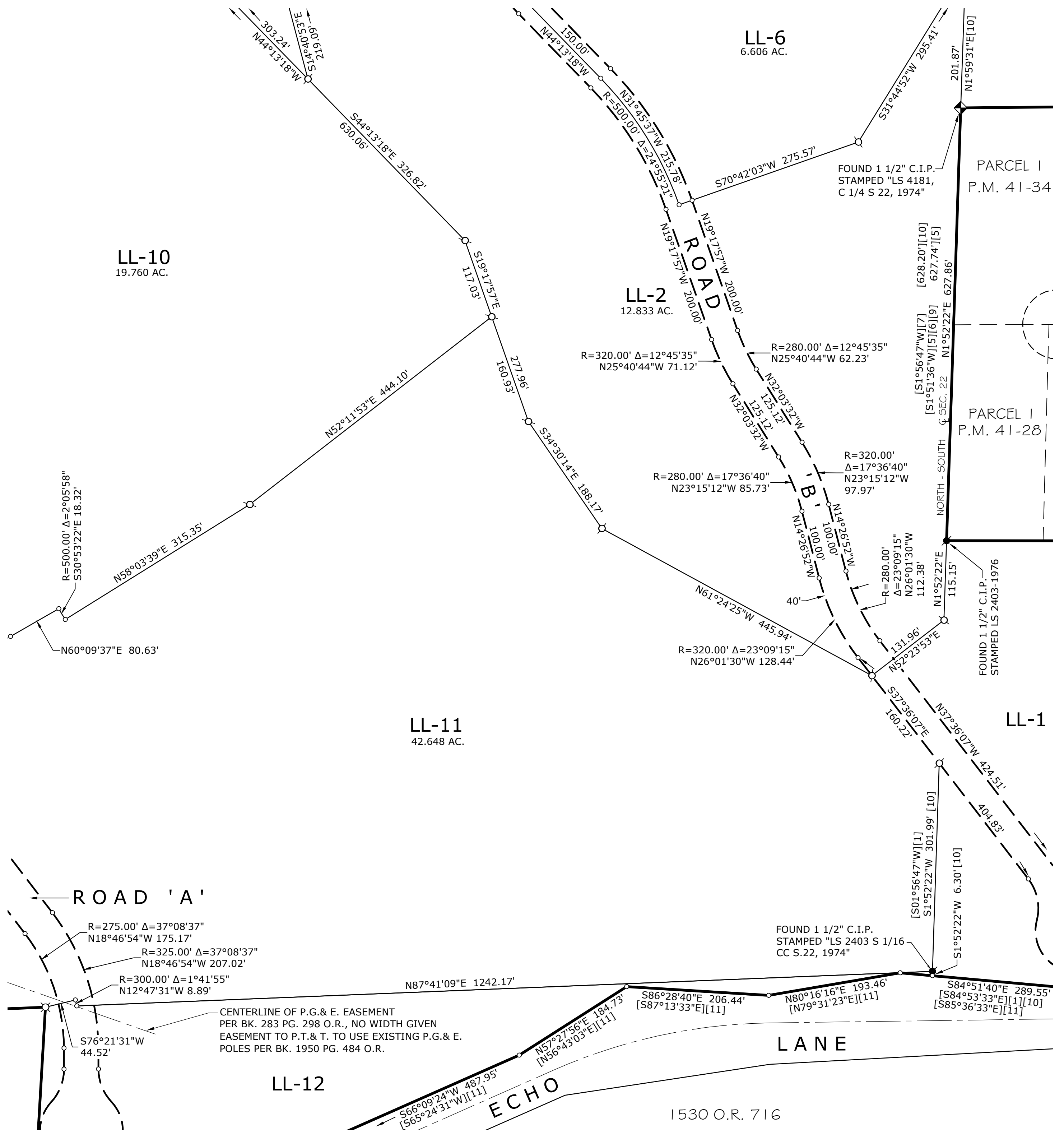
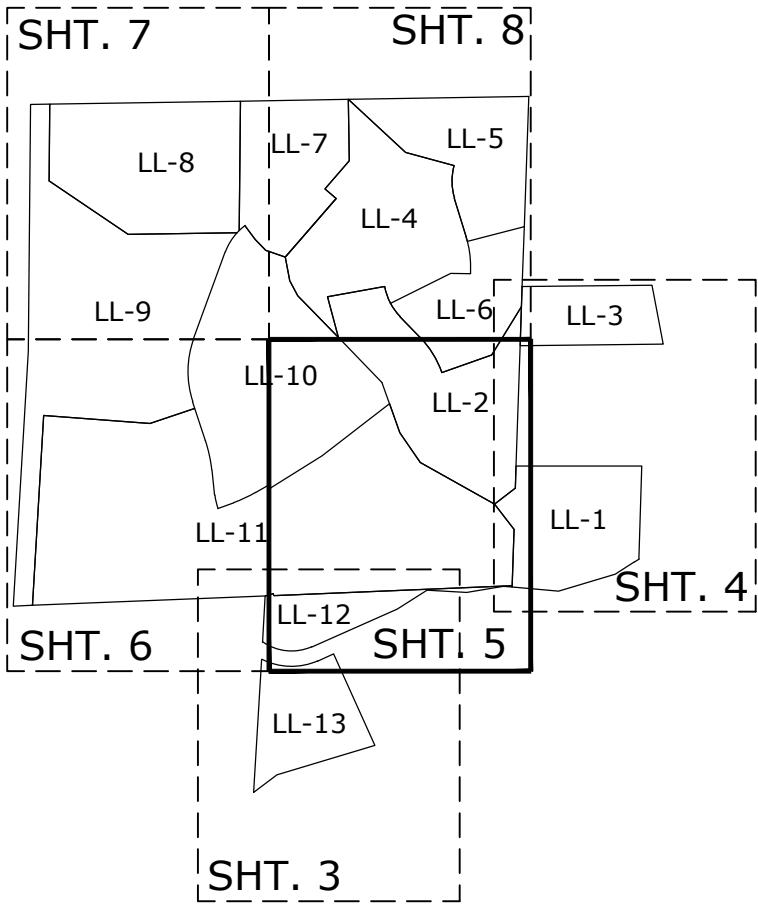
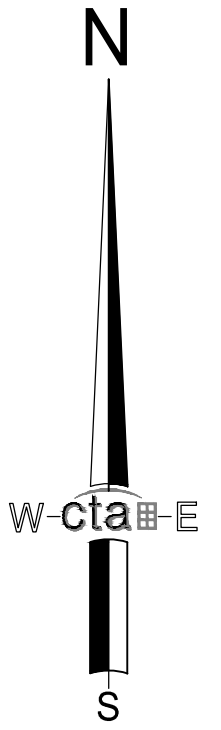

LARGE LOT FINAL MAP OF INDIAN CREEK RANCH

PARCELS 1, 2 & 3 OF PARCEL MAP BK. 50, PG. 51 AND
PORTIONS OF SECTION 22, T. 10 N., R. 10 E., M.D.M.

COUNTY OF EL DORADO STATE OF CALIFORNIA
SCALE: 1"= 100' SHEET 6 OF 8 JANUARY, 2021

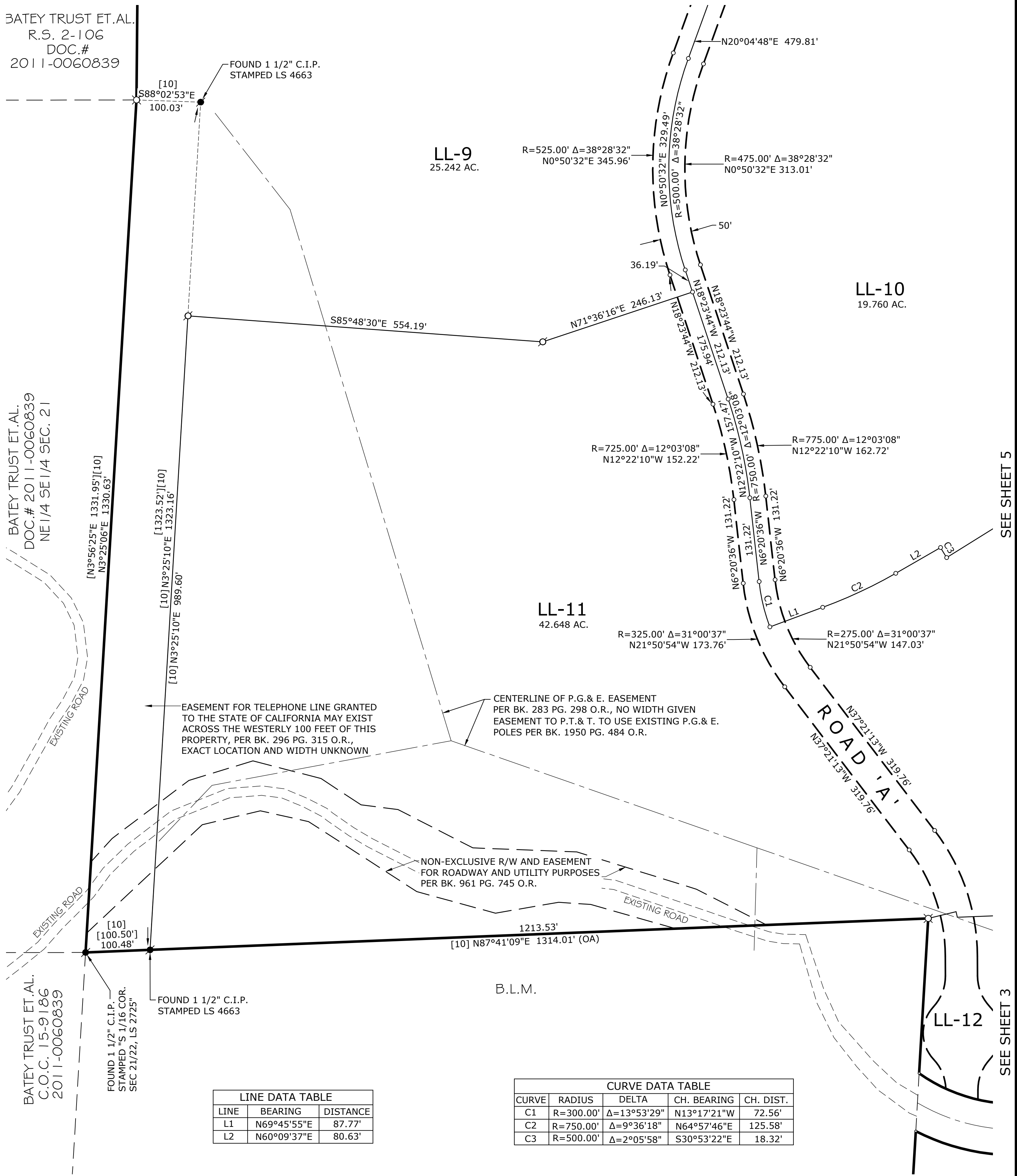
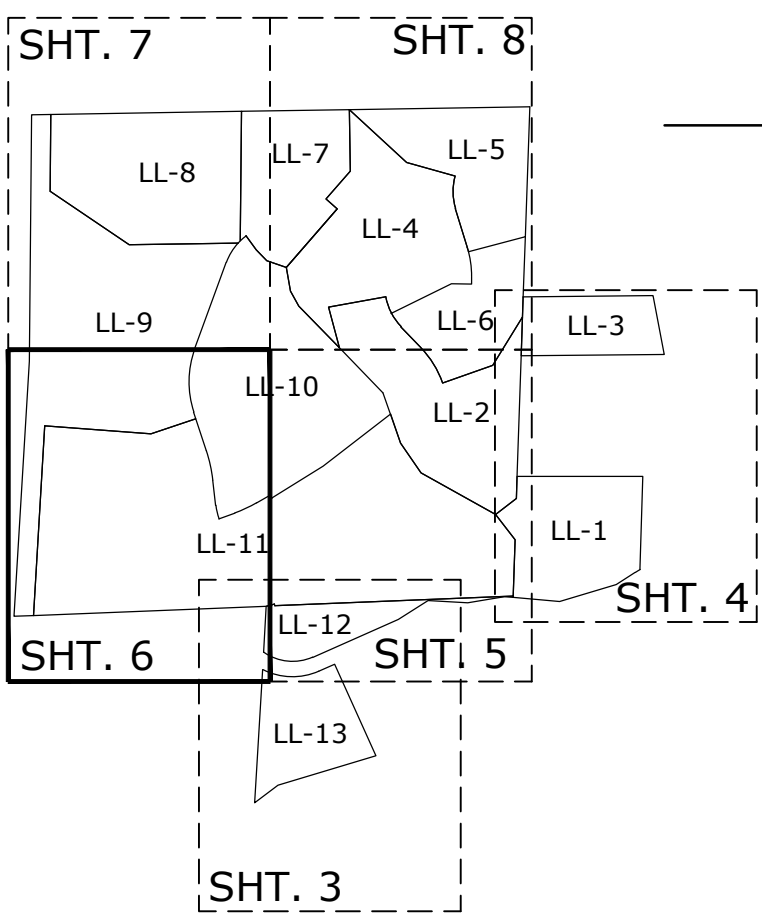
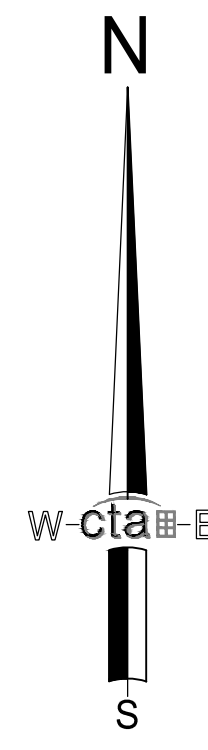

LINE	BEARING	DISTANCE
L1	N69°45'55"E	87.77'
L2	N60°09'37"E	80.63'

CURVE	RADIUS	DELTA	CH. BEARING	CH. DIST.
C1	R=300.00'	Δ=13°53'29"	N13°17'21"W	72.56'
C2	R=750.00'	Δ=9°36'18"	N64°57'46"E	125.58'
C3	R=500.00'	Δ=2°05'58"	S30°53'22"E	18.32'

LARGE LOT FINAL MAP OF INDIAN CREEK RANCH

PARCELS 1, 2 & 3 OF PARCEL MAP BK. 50, PG. 51 AND
PORTIONS OF SECTION 22, T. 10 N., R. 10 E., M.D.M.

COUNTY OF EL DORADO STATE OF CALIFORNIA
SCALE: 1"= 100' SHEET 7 OF 8 JANUARY, 2021

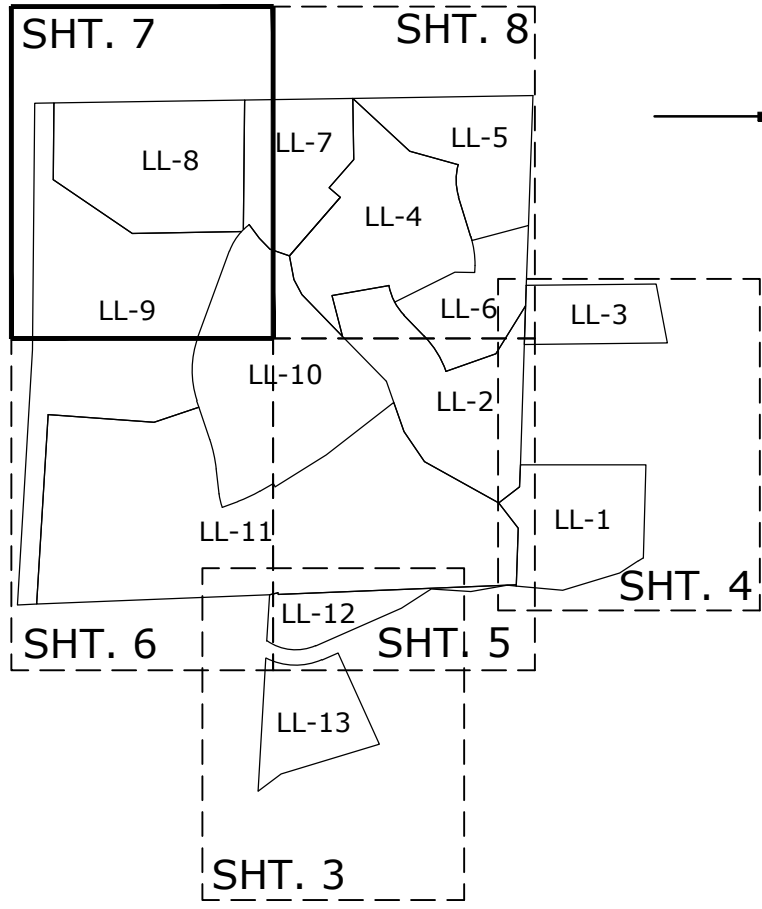
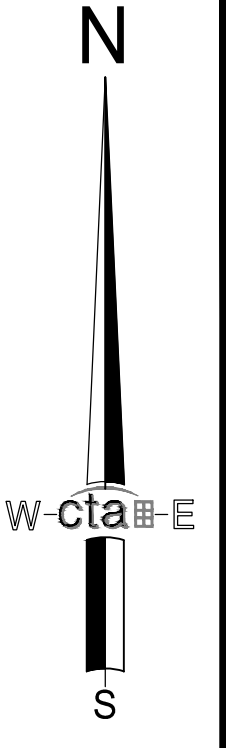

LINE DATA TABLE		
LINE	BEARING	DISTANCE
L1	S36°30'20"E	90.09'
L2	S44°12'54"E	78.87'
L3	S71°08'40"E	107.27'

CURVE DATA TABLE				
CURVE	RADIUS	DELTA	CH. BEARING	CH. DIST.
C1	R=300.00'	Δ=33°24'52"	N36°47'14"E	172.49'
C2	R=300.00'	Δ=22°43'17"	N31°26'26"E	118.19'
C3	R=300.00'	Δ=3°16'43"	N44°26'26"E	17.16'
C4	R=300.00'	Δ=7°24'52"	N49°47'14"E	38.80'

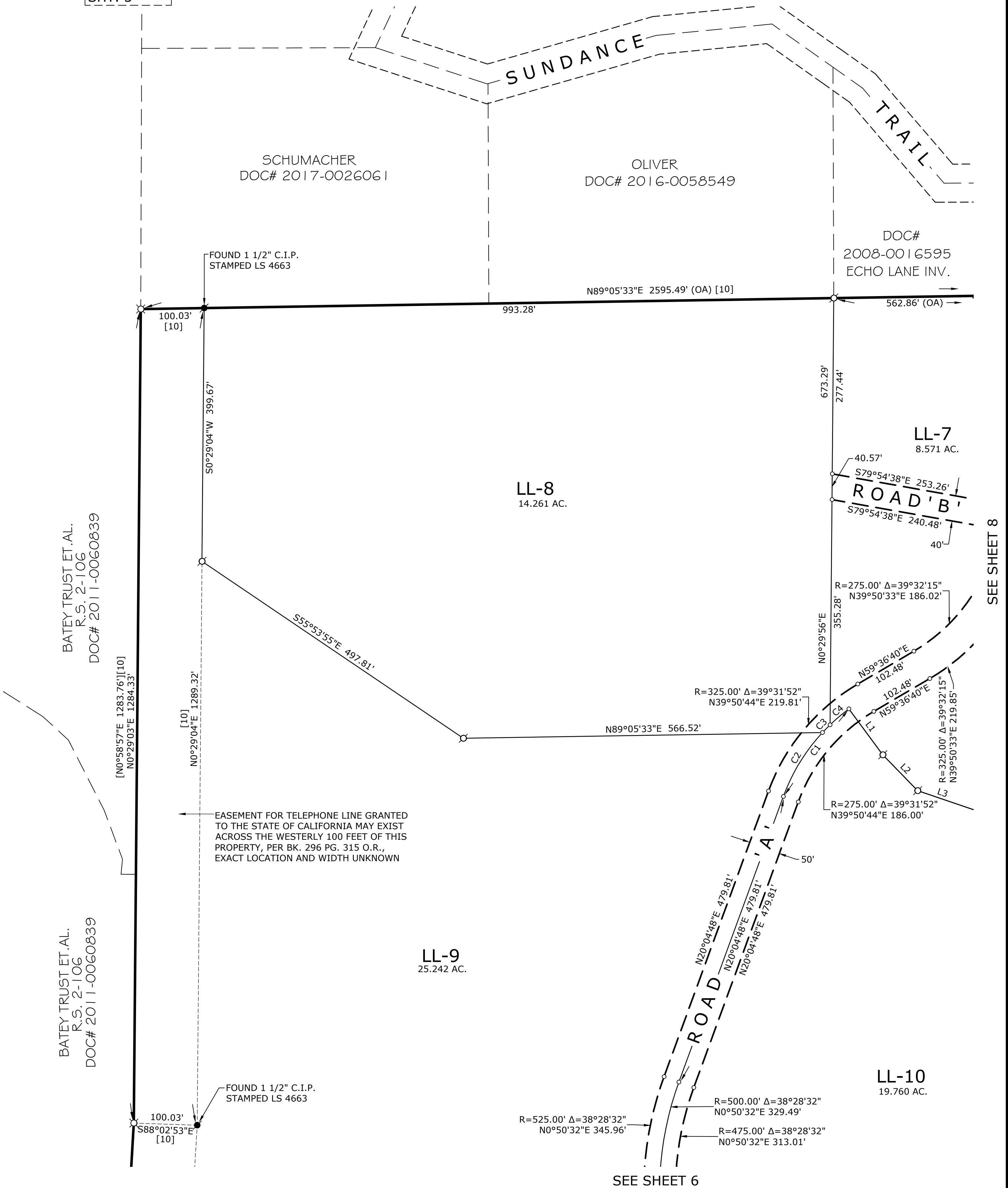

SEE SHEET 8

SEE SHEET 6

LARGE LOT FINAL MAP OF INDIAN CREEK RANCH

PARCELS 1, 2 & 3 OF PARCEL MAP BK. 50, PG. 51 AND
PORTIONS OF SECTION 22, T. 10 N., R. 10 E., M.D.M.

COUNTY OF EL DORADO STATE OF CALIFORNIA
SCALE: 1" = 100' SHEET 8 OF 8 JANUARY, 2021

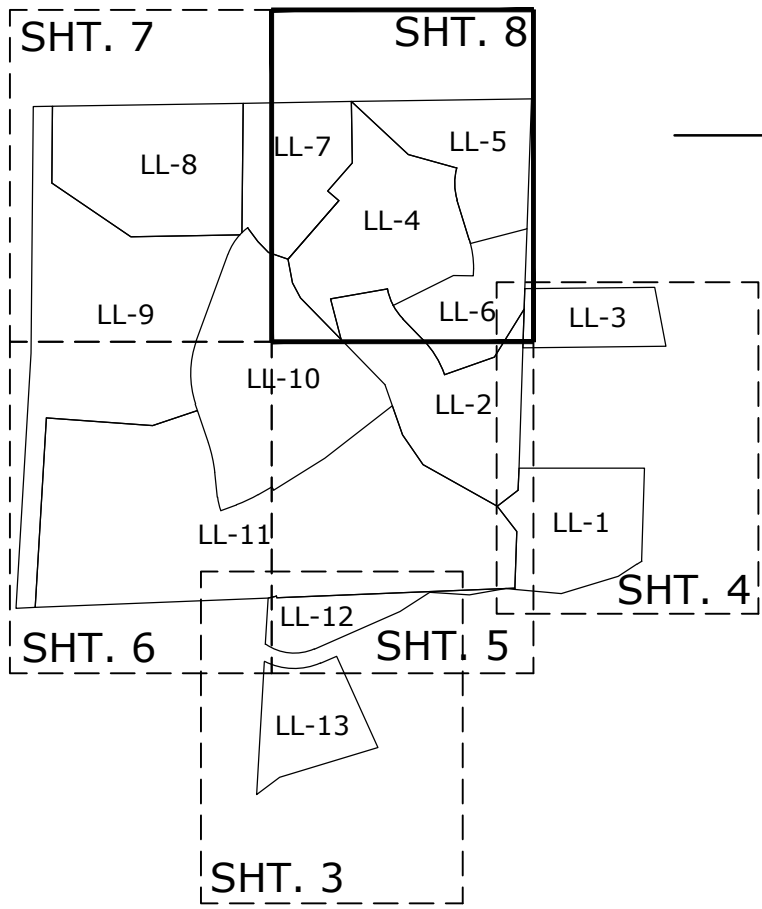

CURVE DATA TABLE				
CURVE	RADIUS	DELTA	CH. BEARING	CH. DIST.
C1	R=275.00'	Δ=0°36'14"	N24°34'56"W	2.90'
C2	R=325.00'	Δ=4°21'46"	N22°42'09"W	24.74'
C3	R=25.00'	Δ=84°41'25"	N59°18'33"E	33.68'
C4	R=320.00'	Δ=1°33'53"	S79°07'41"E	8.74'
C5	R=25.00'	Δ=99°59'03"	N29°55'06"W	38.30'
C6	R=25.00'	Δ=101°16'28"	N70°42'39"E	38.66'
C7	R=280.00'	Δ=9°40'37"	S53°48'49"E	47.23'
C8	R=320.00'	Δ=12°41'15"	S55°19'08"E	70.72'
C9	R=25.00'	Δ=79°29'37"	S21°54'57"E	31.97'
C10	R=480.00'	Δ=3°25'41"	N65°26'03"E	28.71'
C11	R=520.00'	Δ=4°23'42"	N65°55'04"E	39.88'

LINE DATA TABLE		
LINE	BEARING	DISTANCE
L1	S79°54'38"E	253.26'
L2	S79°54'38"E	240.48'
L3	N20°04'25"E	22.37'
L4	N20°04'25"E	22.36'

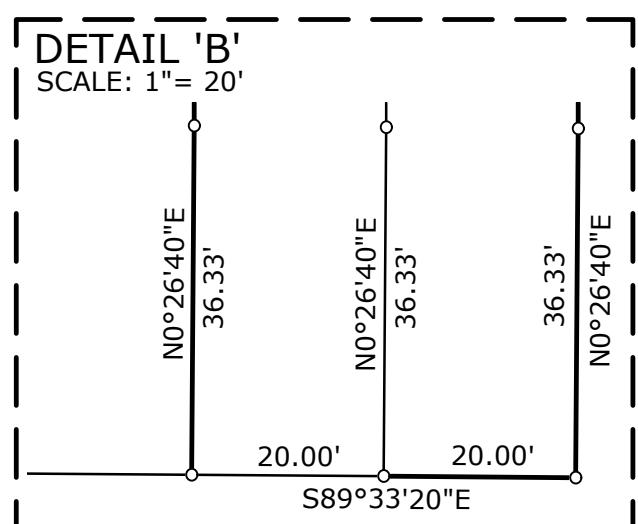
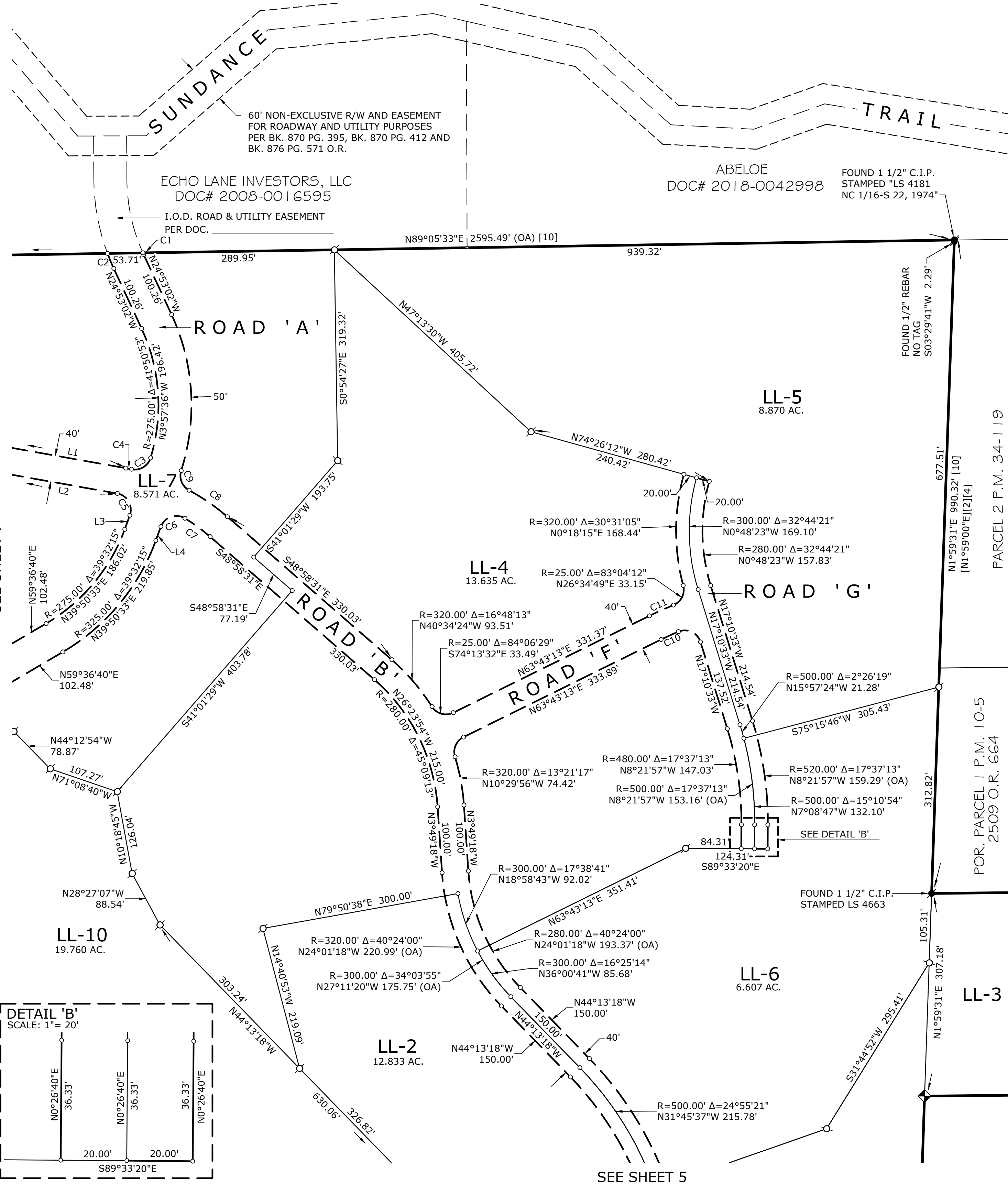
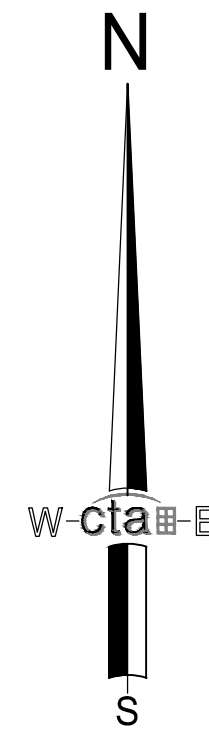

Tentative Subdivision Map

Indian Creek Ranch Job# 5391-05-08
A PORTION OF SECTION 22,
T. 10N., R. 10E., M. 10M.

COUNTY OF EL DORADO STATE OF CALIFORNIA
SEPTEMBER, 2008 1"=100'
SHEET 1 of 1

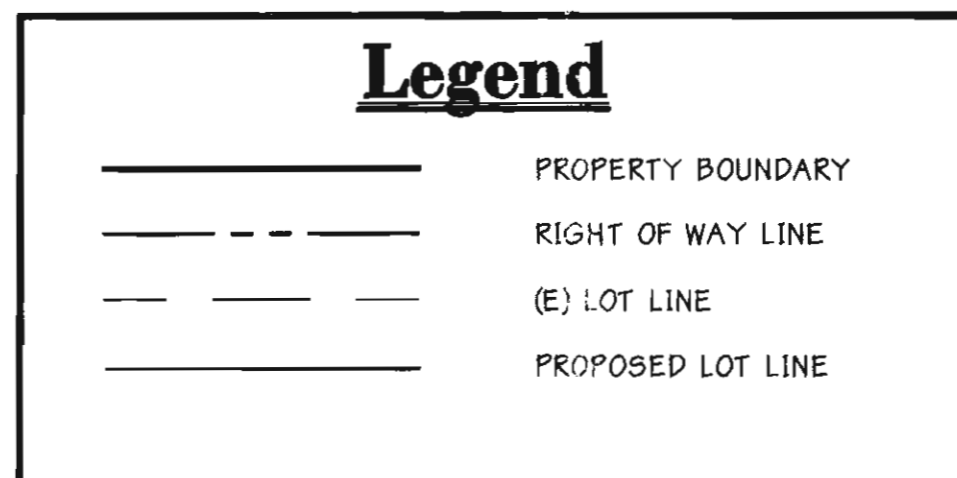
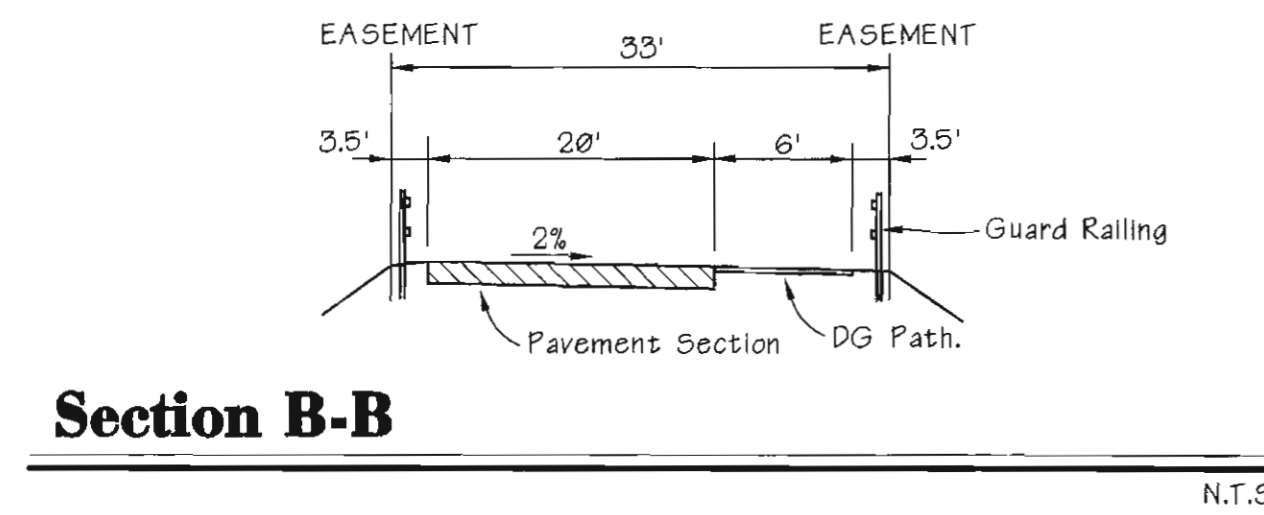
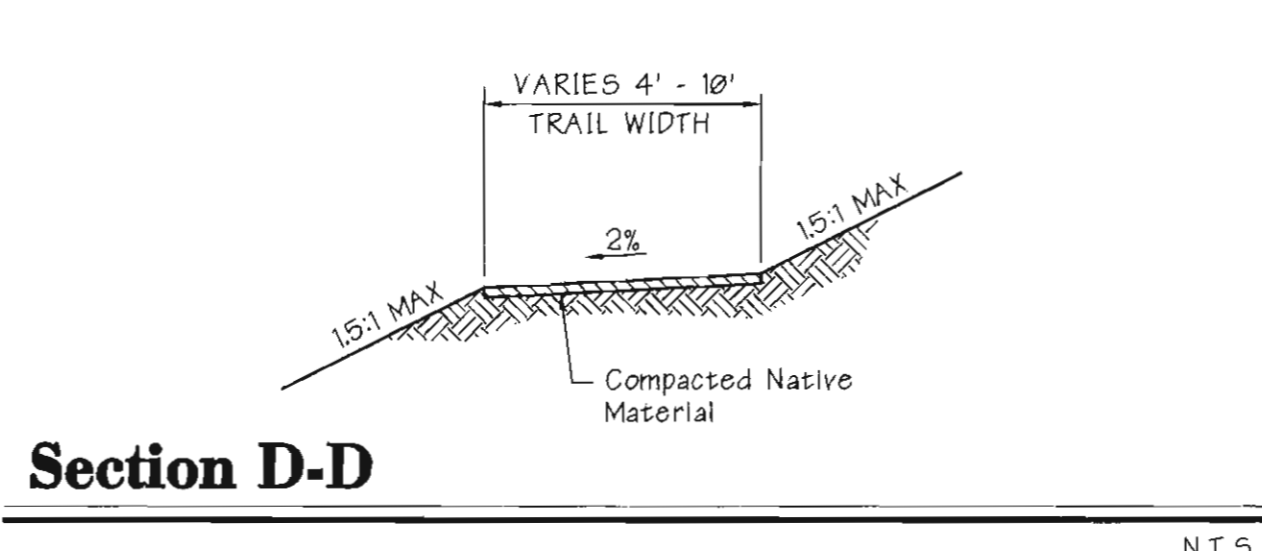
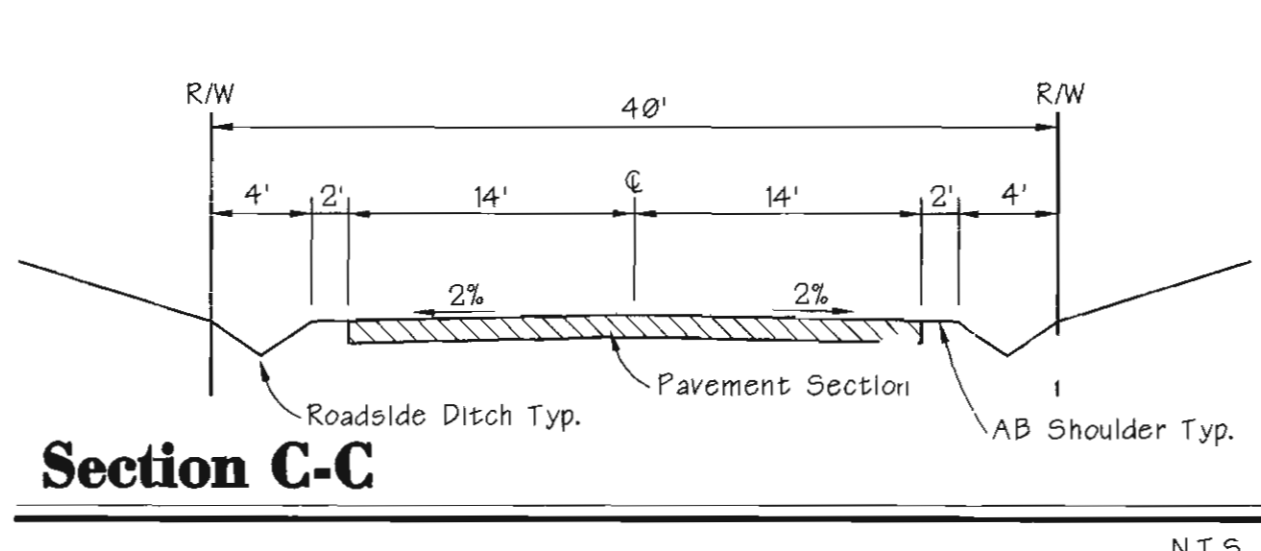
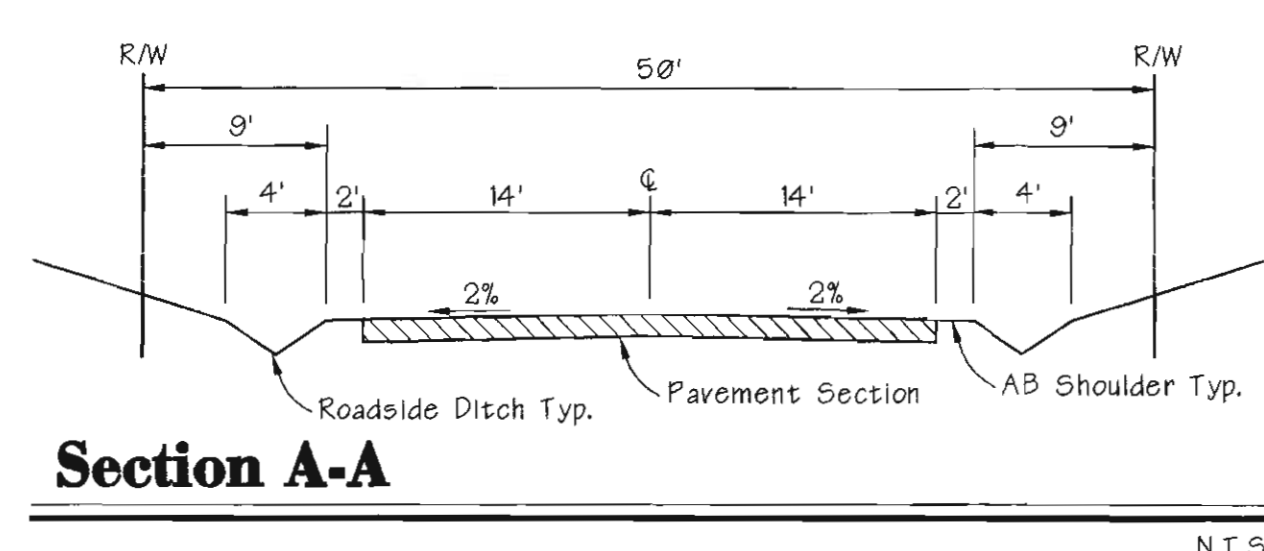

OWNER / APPLICANT: ECHO LANE INVESTORS, LLC
P.O. BOX 638
EL DORADO, CA 95623
(530) 622-6010

MAP PREPARED BY: CARLTON ENGINEERING INC.
3883 PONDEROSA ROAD
SHINGLE SPRINGS, CA 95602
(530) 677-5515

SCALE OF MAP: 1"=100'
CONTOUR INTERVAL: 2 FOOT (2)
SOURCE OF TOPOGRAPHY: AERIAL SURVEY PROVIDED BY: TRI STATE SURVEYING LTD.
SECTION, TOWNSHIP, RANGE: A PORTION OF SECTION 22, T. 10N., R. 10E., M. 10M.
ASSESSOR'S PARCEL NO.: 327-050-02, 327-060-03, 327-060-04, 327-060-07, 327-060-08, 327-070-55, 327-070-56, AND 327-080-04
PRESENT ZONING: A, R3-A
TOTAL PARCEL AREA: 102.83 ACRES
TOTAL NUMBER OF PARCELS: 74
MINIMUM PARCEL AREA: 1.00 ACRES (43,560 SqFt)
WATER SUPPLY: EL DORADO IRRIGATION DISTRICT
SEWAGE DISPOSAL: SEPTIC
STRUCTURAL FIRE PROTECTION: DIAMOND SPRING/EL DORADO DISTRICT
DATE OF PREPARATION: APRIL 2008
NOTE: THIS PROJECT WILL BE CONSTRUCTED IN MULTIPLE PHASES



Area and Land Use Tabulation Table

74 ONE-ACRE MINIMUM RESIDENTIAL LOTS	9150 Acres
5-ACRE MINIMUM RESIDENTIAL (LOT #75)	5.82 Acres
7 LDR OPEN SPACE LOTS	3147 Acres (Net)
OPEN SPACE A	1177 Acres (Net)
OPEN SPACE B	8.77 Acres (Net)
OPEN SPACE C	6.80 Acres (Net)
OPEN SPACE D	4.71 Acres (Net)
OPEN SPACE E	4.50 Acres (Net)
OPEN SPACE F	8.14 Acres (Net)
OPEN SPACE G	8.21 Acres (Net)
OPEN SPACE H	67.56 Acres (Net)
TOTAL LDR OPEN SPACE	102.83 Acres (Net)
4 MDR OPEN SPACE LOTS	5.81 Acres (Net)
OPEN SPACE I	2.24 Acres (Net)
OPEN SPACE J	1.83 Acres (Net)
OPEN SPACE K	8.77 Acres (Net)
OPEN SPACE L	3.95 Acres (Net)
TOTAL MDR OPEN SPACE	16.79 Acres (Net)
MISCELLANEOUS RIGHT-OF-WAY	2.57 Acres
REMAINDER PARCEL	7.19 Acres
TOTAL AREA	102.83 Acres

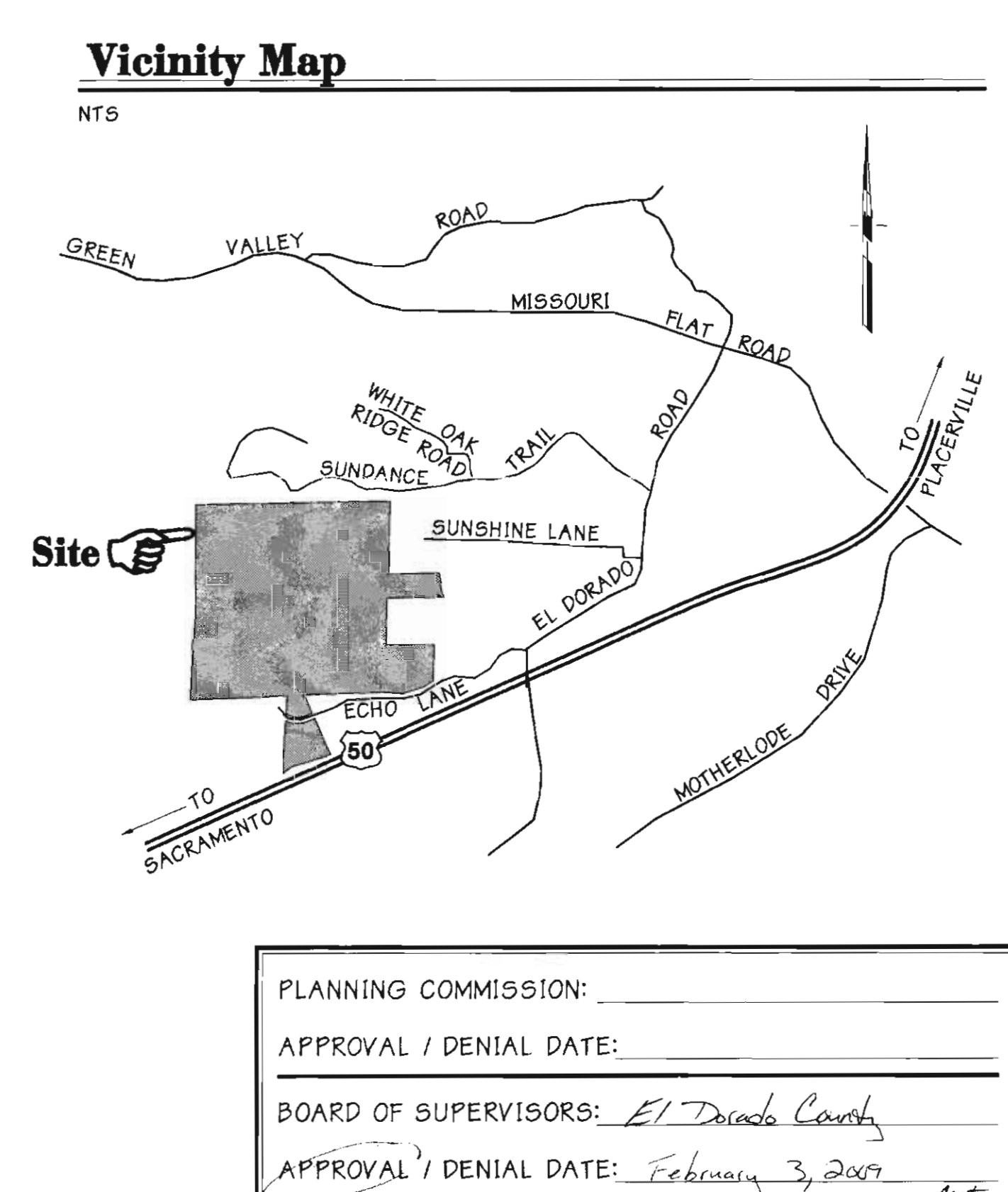

PLANNING COMMISSION: _____
APPROVAL / DENIAL DATE: _____
BOARD OF SUPERVISORS: El Dorado County
APPROVAL / DENIAL DATE: February 3, 2009



**COUNTY OF EL DORADO
DEPARTMENT OF TRANSPORTATION**

Memorandum

Date: February 25, 2021

To: Tom Purciel, Project Planner
El Dorado County Planning Department

From: Adam Bane, Senior Civil Engineer
Senior Civil Engineer
County of El Dorado
Department of Transportation

A handwritten signature in blue ink, appearing to read "A. Bane", is placed to the right of the typed name.

Subject: TM 08-1472 Indian Spring Large Lot Subdivision Map

The Department of Transportation has reviewed the Large Lot Subdivision Map for the Indian Creek Ranch project TM 08-1472. We find the map consistent with the tentative map. No improvements are required at this time, and the roads shown will be constructed with the filing of each subsequent final map for this project.

VERIFICATION OF FINAL MAP CONFORMANCE WITH CONDITIONS OF APPROVAL

Final Map TM-F20-0006 – Indian Creek Ranch Large Lot Final Map

TM08-1472-E– As approved by the Planning Commission May 26, 2016

Conditions of Approval

MITIGATION MEASURES

The following mitigation measures are required as a means to reduce potential significant environmental effects to a level of insignificance:

1. **MM AQ-1:** A Fugitive Dust Plan (FDP) Application with appropriate fees shall be submitted to and approved by the El Dorado County Air Pollution Control District (APCD) with appropriate fees and approved by the APCD prior to start of project construction.

Timing/Implementation: Prior to issuance of grading and building permits

Enforcement/Monitoring: El Dorado County Planning Services

Staff Verification: This condition does not apply. This Large Lot Final Map is proposed for financing purposes only; no construction, improvements, soil disturbance or other dust-generating activities are proposed as part of this Large Lot Final Map. Conformance with this condition will be required as part of future small lot Final Maps.

2. **MM BIO-1:** If construction activities (for either road development or lot development) are scheduled to commence within the typical breeding season for a bird of prey or Migratory Bird Treaty Act (MBTA) bird (March 1 through August 31), on-site pre-construction surveys for raptors and their nests shall be conducted by a qualified biologist. The biologist shall adhere to the following protocol:
 - The biologist shall survey for active nests in the construction footprint and in accessible areas within 250 feet of the construction footprint within 30 days prior to construction. If no active nest of a bird of prey or MBTA bird is found, then no further mitigation is necessary.
 - If an active nest of a bird of prey or MBTA bird is found, then the biologist shall flag a minimum 250-foot Environmentally Sensitive Area (ESA) around the nest if the nest is of a bird of prey, and a

minimum 100-foot ESA around the nest if the nest is of an MBTA bird other than a bird of prey.

- No construction activity shall be allowed in the buffer until the biologist determines that the nest is no longer active, or unless monitoring determines that a smaller buffer will protect the active nest. The buffer may be reduced if the biologist monitors the construction activities and determines that no disturbance to the active nest is occurring. The size of suitable buffers depends upon the species of the bird, the location of the nest relative to the project, project activities during the time the nest is active, and other project specific conditions.
- If a nest becomes active after construction has started, then the bird is considered to be acclimated to construction activity, and no further mitigation is required.

Timing/Implementation: Prior to issuance of grading and building permits the applicant shall include this measure as a note on all building plans and grading plans.

Enforcement/Monitoring: El Dorado County Planning Services shall verify that the above measure has been incorporated on the plans prior to issuance of a grading permit. The Division shall coordinate with the applicant and/or biologist, assess the pertinent surveys/studies, and conduct on-site verification for conformance with this measure.

Staff Verification: This condition does not apply. This Large Lot Final Map is proposed for financing purposes only; no construction, improvements, grading or soil disturbance is proposed as part of this Large Lot Final Map. Conformance with this condition will be required as part of future small lot Final Maps.

3. **MM LU-1:** All areas designated on the tentative map as an “Open Space Lot” shall be zoned as Open Space as part of the rezone application. Minor deviations from approved exhibits shall be allowed as needed to accommodate roads and grading adjustments that may occur during development of final improvement plans and the final map.

Plan Requirements/Timing: Prior to final approval, the applicant shall amend the project description to request that all areas designated on the recorded final map as Open Space Lots be rezoned to an Open Space zoning district.

Compliance: El Dorado County Planning Services shall incorporate the revised project description into all planning documents forwarded to the Planning Commission and Board of Supervisors. Prior to the issuance of any development permits (building or grading permits), the County shall amend zoning maps consistent with the tentative map submitted for recordation as the final map. Planning Services shall review submitted maps to ensure consistency with the intent of this condition of approval, which is that all

areas designated as an open space lot be zoned as such. The applicant shall be responsible for coordinating with El Dorado County Planning Services to ensure zoning maps have been updated consistent with the proposed final map.

Staff Verification: *This condition does not apply to the current project phase. This Large Lot Final Map is proposed for financing purposes only and no development activities are proposed as part of this Large Lot Final Map. On February 3, 2009, the Board of Supervisors adopted Rezone Ordinance No. 4809 (Attachment B, Exhibit E) authorizing open space zones as shown on the approved Tentative Map (Attachment B, Exhibit G). Open space zone boundaries will be reviewed for conformance with the approved tentative map, and County zoning map updates completed, as part of future small lot Final Maps consistent with Rezone Ordinance No. 4809.*

4. **MM NOI-1:** The applicant shall construct property line noise barriers measuring 6-7 feet high above the existing ground elevations for Lots 65, 66 and 71 consistent with the Bollard Acoustical Consultants, Inc. Environmental Noise Assessment prepared for the Indian Creek Ranch Single-Family Residential Development dated March 5, 2008. Alternatively, the applicant may provide El Dorado County Planning Services with updated acoustical analyses for these lots which provide for alternative methods of noise attenuation, including, but not limited to, siting of building envelopes on the final map outside areas of exposure in exceedance of General Plan Noise Element criteria (60 dB L_{dn} for residential uses).

Timing/Implementation: Prior to issuance of grading and building permits for individual lots 65, 66, and 71, El Dorado County Planning Services shall verify that building plans include noise barriers consistent with the requirements of the above-referenced noise study. Alternatively, updated analyses may be presented to Planning Services for review and approval that describe alternative methods of noise attenuation which shall be implemented as part of project development on identified lots.

Enforcement/Monitoring: El Dorado County Planning Services

Staff Verification: *This condition does not apply. This Large Lot Final Map is proposed for financing purposes only; no construction, improvements, grading, soil disturbance or building envelopes are proposed as part of this Large Lot Final Map. Conformance with this condition will be required as part of future small lot Final Maps.*

CONDITIONS OF APPROVAL

Planning Services

5. The project, as approved, consists of the following:

This rezone, planned development and tentative subdivision map are based upon and limited to compliance with the project description, the Planning Commission hearing exhibit marked Exhibits F-L & P (Rezone/Planned Development/Tentative Map) dated December 11, 2008, and conditions of approval set forth below. Any deviations from the project description, exhibits, or conditions must be reviewed and approved by the County for conformity with this approval. Deviations may require approved changes to the permit and/or further environmental review. Deviations without the above-described approval will constitute a violation of permit approval.

Project Description: The project includes a request for a zone change from Single-Family Three-Acre Residential (R3A) and Agriculture (A) to Estate Residential 5-acre planned development (RE-5-PD) and Single-Family Three-Acre Residential Planned Development (R3A-PD), a Phased Tentative Subdivision Map to create 75 residential lots ranging in size from 1.0 to 2.5 acres (with the exception of Lot 75 which comprises 5.02 acres and would be held to the development standards of the RE-5 zone district) and eleven lettered open space lots (to be combined and zoned open space) totaling 76.61 acres, and a Development Plan to allow clustering of lots and a reduction in the minimum parcel size of five acres in the RE-5 zone district and the minimum parcel size of three acres in the R3A zone district, to allow for a density bonus, to apply the development standards of the R1A zone district, and allow for a reduction in side yard setbacks to 10 feet, but maintain a total side yard setback of 30 feet per lot. Multiple or “phased” Final Maps are proposed to be filed pursuant to Government Code Section 66456.1. Access to the project would be provided by two road connections on Echo Lane. Emergency access would be provided by a road connection on Sundance Trail. The project proposes to use the Density Bonus provision for thirty (30) additional residential lots. Design waivers have been requested for modifications to DOT road standards. DOT supports the three requested design waivers.

The gross and net lot area shall comply with Table 1 below:

TABLE 1. Gross and Net Lot Areas					
Lot No.	Gross area (S.F.)	Net Area (S.F.)	Lot No.	Gross Area (S.F.)	Net Area (S.F.)
1	54,605	28,537	45	57,379	32,786
2	43,862	24,820	46	55,169	33,967
3	45,842	24,763	47	54,128	25,600
4	46,398	27,724	48	69,593	34,684
5	43,480	25,307	49	64,618	41,995
6	45,328	26,343	50	54,577	29,774
7	43,908	25,341	51	61,019	37,389
8	45,328	23,239	52	52,224	29,165
9	53,047	24,052	53	60,502	37,396
10	45,988	22,802	54	55,787	30,150
11	48,638	25,787	55	63,345	33,327
12	50,025	30,792	56	77,685	31,695
13	45,775	27,127	57	110,407	65,465

14	49,829	30,158	58	65,020	35,657
15	51,167	31,324	59	50,157	28,194
16	52,229	31,233	60	48,101	28,432
17	67,328	31,146	61	47,474	28,375
18	60,685	31,206	62	46,963	28,282
19	57,964	30,867	63	49,294	28,243
20	46,155	27,505	64	46,089	27,472
21	50,224	27,303	65	46,563	26,238
22	47,079	24,376	66	84,817	50,756
23	53,944	22,254	67	48,546	24,445
24	55,560	33,301	68	46,407	24,843
25	49,146	27,295	69	46,893	24,765
26	52,366	22,499	70	50,002	19,251
27	46,464	27,648	71	52,072	24,562
28	53,340	22,959	72	50,951	30,202
29	59,068	26,087	73	46,656	22,188
30	50,011	30,126	74	53,639	22,645
31	52,915	29,918	75*	218,671	N/A
32	72,182	41,911	Open Space "A"	32.69 ac.	31.47 ac.
33	75,945	32,761	Open Space "B"	11.81 ac.	11.77 ac.
34	49,384	29,790	Open Space "C"	8.99 ac.	8.77 ac.
35	47,380	28,154	Open Space "D"	6.0 ac.	6.0 ac.
36	48,646	28,062	Open Space "E"	4.89 ac.	4.71 ac.
37	48,967	28,035	Open Space "F"	4.81 ac.	4.39 ac.
38	47,980	28,183	Open Space "G"	0.37 ac.	0.14 ac.
39	47,652	28,455	Open Space "H"	0.5 ac.	0.31 ac.
40	56,210	28,353	Open Space "I"	5.01 ac.	5.01 ac.
41	48,967	29,730	Open Space "J"	2.24 ac.	2.24 ac.
42	60,210	38,955	Open Space "K"	1.28 ac.	1.03 ac.
43	60,478	31,906	Remainder Parcel	7.13 ac.	7.13 ac.
44	53,936	31,840	*Lot 75 is not to be developed with this map and shall be required to adhere to the development standards of the RE-5 Zone District.		

The oak removal as part of construction of the on-site access road and future residential development of the site shall comply with Table 3 below:

TABLE 3: Oak Canopy Removal Summary		
Total Oak Canopy to be Removed (Acres)	Canopy Removed for Road Improvements (Acres)	Proposed Canopy Removed for Residential Development Envelopes (Acres)
11.93	5.78	6.15

The grading, development, use, and maintenance of the property, the size, shape, arrangement, and location of structures, parking areas and landscape areas, and the

protection and preservation of resources shall conform to the project description above and the hearing exhibits and conditions of approval below. The property and any portions thereof shall be sold, leased or financed in compliance with this project description and the approved hearing exhibits and conditions of approval hereto. All plans (such as Landscape and Tree Protection Plans) must be submitted for review and approval and shall be implemented as approved by the County.

Staff Verification: This condition does not apply to this Large Lot Final Map. Conformance with this condition will be required as part of future small lot Final Maps.

6. All site improvements shall conform to Exhibits F-L.

Staff Verification: This condition does not apply. This Large Lot Final Map is proposed for financing purposes only; no improvements are proposed as part of this Large Lot Final Map. Conformance with this condition will be required as part of future small lot Final Maps.

7. The developer shall pay the mitigation in-lieu fee or provide a replacement plan for all oak canopy removed as part of road and infrastructure improvements (Total 5.78 acres). The mitigation fee shall be paid at a 1:1 ratio as required by the Oak Woodland Conservation Ordinance and shall be based on the fee established by the Board of Supervisors. The applicant shall provide to Planning Services proof of payment of the mitigation in-lieu fee or replacement plan, prepared by a licensed arborist, prior to issuance of a grading permit or removal of any oak trees.

Staff Verification: This condition does not apply. This Large Lot Final Map is proposed for financing purposes only; no improvements are proposed as part of this Large Lot Final Map. Conformance with this condition will be required as part of future small lot Final Maps.

8. The Final Subdivision Map shall include the following notes:

- a. Oak tree removal required for lot development shall adhere to allocated estimates contained in Exhibit L (Oak Tree Removal Allocation). Individual property owners shall pay the mitigation fee or provide a replacement plan. Lot owners/developers shall demonstrate, consistent with guidelines contained in the Oak Woodland Conservation Ordinance, that proposed removals are consistent with the estimated allocation. Replacement plans shall be prepared by a licensed arborist at a 1:1 ratio as required by the Oak Woodland Conservation Ordinance and shall be based on the fee established by the Board of Supervisors.
- b. Any oak canopy removal beyond that allocated in Exhibit L (Oak Tree Removal Allocation) for any individual lot within the subdivision, or allocated to the road or infrastructure improvements, shall pay the applicable mitigation fee or provide a replacement plan. Replacement plans shall be prepared by a licensed arborist at a

2:1 ratio as required by the Oak Woodland Management Plan and shall be based on the fee established by the Board of Supervisors.

Staff Verification: This condition does not apply. This Large Lot Final Map is proposed for financing purposes only. Conformance with this condition will be required as part of future small lot Final Maps.

9. All fees associated with the Tentative Subdivision Map shall be paid prior to filing the Final Subdivision Map.

Staff Verification: Condition satisfied. All applicable Tentative Subdivision Map fees have been paid.

10. Construction activities shall be limited to the hours of 7 a.m. to 7 p.m. during weekdays and 8 a.m. to 5 p.m. on weekends and on federally-recognized holidays. Exceptions are allowed if it can be shown that construction beyond these times is necessary to alleviate traffic congestion and safety hazards. Planning Services shall verify this requirement is placed on the Grading Plans prior to issuance of a grading permit.

Staff Verification: This condition does not apply. This Large Lot Final Map is proposed for financing purposes only; no construction activities are proposed as part of this Large Lot Final Map. Conformance with this condition will be required as part of future small lot Final Maps.

11. Prior to issuance of a grading permit the applicant shall provide a written description, together with appropriate documentation, showing conformance of the project with each condition imposed as part of the project approval. The applicant shall also schedule an inspection by Planning Services if deemed necessary prior to issuance of a grading permit for verification of compliance with applicable conditions of approval.

Staff Verification: This condition does not apply. This Large Lot Final Map is proposed for financing purposes only; no grading or soil disturbing activities are proposed as part of this Large Lot Final Map. Conformance with this condition will be required as part of future small lot Final Maps.

12. In the event that previously unknown cultural resources are discovered during construction, operations shall stop in the immediate vicinity of the find and a qualified archaeologist shall be consulted to determine whether the resource requires further study. The qualified archeologist shall make recommendations on the measures to be implemented to protect the discovered resources, including but not limited to excavation of the finds and evaluation of the finds, in accordance with § 15064.5 of the CEQA Guidelines. Cultural resources could consist of, but are not limited to, stone, bone, wood, or shell artifacts or features, including hearths, structural remains, or historic dumpsites.

Staff Verification: This condition does not apply. This Large Lot Final Map is proposed for financing purposes only; no construction activities are proposed as part of this Large Lot Final Map. Conformance with this condition will be required as part of future small lot Final Maps.

13. If human remains are encountered during earth-disturbing activities within the project area, all work in the adjacent area shall stop immediately and the El Dorado County Coroner's office shall be notified. If the remains are determined to be Native American in origin, both the Native American Heritage Commission (NAHC) and any identified descendants shall be notified by the coroner and recommendations for treatment solicited (CEQA Guidelines § 15064.5; Health and Safety Code § 7050.5; Public Resources Code §§ 5097.94 and 5097.98).

Staff Verification: This condition does not apply. This Large Lot Final Map is proposed for financing purposes only; no earth-disturbing activities are proposed as part of this Large Lot Final Map. Conformance with this condition will be required as part of future small lot Final Maps.

14. Prior to approval of the final map by the Board of Supervisors, the subdivider shall be required to form a County Service Area Zone of Benefit, or other entity to fund the maintenance of drainage facilities and improvement services. The funding mechanism for these services must be established prior to approval of the final map and shall include a provision for future increased funding requirements.

Staff Verification: This condition does not apply to this Large Lot Final Map. This Large Lot Final Map is proposed for financing purposes only. Conformance with this condition will be required as part of future small lot Final Maps.

15. At time of final map filing, CC&R's shall be submitted and reviewed by Planning Services and the Department of Transportation.

Staff Verification: This condition does not apply to this Large Lot Final Map. This Large Lot Final Map is proposed for financing purposes only. Conformance with this condition will be required for all future small lot Final Maps.

16. At the time of map filing, all open space lots shall be dedicated to a Homeowner's Association or similar entity as open space with an appropriate maintenance program.

Staff Verification: This condition does not apply to this Large Lot Final Map. This Large Lot Final Map is proposed for financing purposes only. Conformance with this condition will be required for all future small lot Final Maps.

17. This Tentative Subdivision Map shall expire on February 3, 2021 unless the final one-year discretionary time extension has been requested.

Staff Verification: Condition Satisfied. This Large Lot Final Map application was timely filed as the application was submitted to the County on July 29, 2020, prior to the Tentative Map expiration date.

18. The final map shall show all drainage easements consistent with the County of El Dorado Drainage Manual, the project final drainage plan, and the project improvement plans.

Staff Verification: This condition does not apply to this Large Lot Final Map. This Large Lot Final Map is proposed for financing purposes only. Conformance with this condition will be required for all future small lot Final Maps.

19. The location of fire hydrants and systems for fire flows are to meet the requirements of the Diamond Springs - El Dorado Fire Protection District. The location of hydrants shall be shown on the improvement plans which shall be subject to the approval of the fire protection district. If fire flows cannot be met, all habitable structures shall be sprinklered in accordance with Fire District requirements. This condition shall be included in the CC&Rs for the project.

Staff Verification: This condition does not apply to this Large Lot Final Map. This Large Lot Final Map is proposed for financing purposes only. Conformance with this condition will be required for all future small lot Final Maps.

20. A meter award letter or similar document shall be provided by the water purveyor prior to filing the final map.

Staff Verification: This condition does not apply to this Large Lot Final Map. This Large Lot Final Map is proposed for financing purposes only. Conformance with this condition will be required for all future small lot Final Maps.

21. The subdivision is subject to parkland dedication in-lieu fees based on values supplied by the Assessor's Office and calculated in accordance with Section 16.12.090 of the County Code. The fees shall be paid at the time of filing the final map.

Staff Verification: This condition does not apply to this Large Lot Final Map. This Large Lot Final Map is proposed for financing purposes only. Conformance with this condition will be required for all future small lot Final Maps.

22. The subdivider shall be subject to a \$150.⁰⁰ appraisal fee payable to the El Dorado County Assessor for the determination of parkland dedication in-lieu fees.

Staff Verification: This condition does not apply to this Large Lot Final Map. This Large Lot Final Map is proposed for financing purposes only. Conformance with this condition will be required for all future small lot Final Maps.

23. Where the subdivider is required to make improvements on land which neither the subdivider nor the County has sufficient title or interest to make such improvements, prior to filing of any final map or parcel map, the subdivider shall submit to the Planning Director for approval:
 - a. A legal description prepared by a civil engineer or land surveyor of the land necessary to be acquired to complete the off-site improvements.

- b. Improvement plans prepared by a civil engineer of the required off-site improvements.
- c. An appraisal prepared by a professional appraiser of the cost of land necessary to complete the off-site improvements.

Prior to the filing of the final map, the subdivider shall enter into an agreement pursuant to Government Code Section 66462.5 to complete the required off-site improvements including the full costs of acquiring any real property interests necessary to complete the required improvements.

In addition to the agreement, the subdivider shall provide a cash deposit, letter of credit, or other acceptable surety in an amount sufficient to pay such costs including legal costs subject to the approval of County Counsel.

Staff Verification: This condition does not apply to this Large Lot Final Map as no improvements are proposed as part of this project phase. This Large Lot Final Map is proposed for financing purposes only. Conformance with this condition will be required for all future small lot Final Maps.

- 24. The developer shall pay all applicable school fees prior to the issuance of any building permits for individual lots.

Staff Verification: This condition does not apply to this Large Lot Final Map. This Large Lot Final Map is proposed for financing purposes only. Conformance with this condition will be required for all future small lot Final Maps.

Diamond Springs - El Dorado Fire Protection District

- 25. Minimum fire flow required is 1,500 gpm @ 20 psi for 2 hours for residential units larger than 3,600 square feet. If the square footage is below 3,600 square feet, the minimum fire flow will be 1,000 gpm @ 20 psi for 2 hours.

Staff Verification: This condition does not apply to this Large Lot Final Map. This Large Lot Final Map is proposed for financing purposes only. Conformance with this condition will be required for all future small lot Final Maps.

- 26. The applicant shall provide documentation from EID and the Fire District to show that the system will meet required fire flow for this project.

Staff Verification: This condition does not apply to this Large Lot Final Map. This Large Lot Final Map is proposed for financing purposes only. Conformance with this condition will be required for all future small lot Final Maps.

- 27. Hydrant locations shall be approved by the Fire District on the Civil Drawings.

Staff Verification: This condition does not apply to this Large Lot Final Map. This Large Lot Final Map is proposed for financing purposes only. Conformance with this condition will be required for all future small lot Final Maps.

28. All driveways shall provide a minimum 12 foot traffic lane, with unobstructed horizontal clearance of 14 feet and unobstructed vertical clearance of 15 feet along its entire length, and be capable of supporting a minimum 40,000 pound load.

Staff Verification: This condition does not apply to this Large Lot Final Map. This Large Lot Final Map is proposed for financing purposes only. Conformance with this condition will be required for all future small lot Final Maps.

29. Driveway grades exceeding 16 percent shall be of an all weather surface (pavement or asphalt).

Staff Verification: This condition does not apply to this Large Lot Final Map. This Large Lot Final Map is proposed for financing purposes only. Conformance with this condition will be required for all future small lot Final Maps.

30. Driveways grades exceeding 20 percent shall be approved by the Diamond Springs-El Dorado Fire District. Approval may include a deed restriction for a NFPA 13D residential sprinkler system with 3,000 gallons of dedicated onsite water storage for each parcel for fire protection.

Staff Verification: This condition does not apply to this Large Lot Final Map. This Large Lot Final Map is proposed for financing purposes only. Conformance with this condition will be required for all future small lot Final Maps.

31. Driveways exceeding 150 feet in length, but less than 800 feet in length, shall provide a turnout near the midpoint of the driveway. Where the driveway exceeds 800 feet, turnouts shall be provided no more than 400 feet apart.

Staff Verification: This condition does not apply to this Large Lot Final Map. This Large Lot Final Map is proposed for financing purposes only. Conformance with this condition will be required for all future small lot Final Maps.

32. All roadways will be all weather surfaces, to El Dorado County Standards. If there will be parking on one side of the road, the road shall be 30 feet minimum width. Parking on both sides of the road will require 40 feet minimum road width; appropriate, associated signage and road markings shall apply and be provided.

Staff Verification: This condition does not apply to this Large Lot Final Map. This Large Lot Final Map is proposed for financing purposes only. Conformance with this condition will be required for all future small lot Final Maps.

33. A turnaround shall be provided to all building sites with driveways over 300 feet in length. Turnarounds shall be within 50 feet of the building with a minimum turning radius of 40 feet from the center line of the road. Applicant may use a hammerhead “T,” a modified “T” or a modified “Y” in lieu of a circular type turnaround, per El Dorado County DOT Standards 101C.

Staff Verification: This condition does not apply to this Large Lot Final Map. This Large Lot Final Map is proposed for financing purposes only. Conformance with this condition will be required for all future small lot Final Maps.

34. Entry Gates: The two main entries on Echo Lane and the secondary access road from Road “A” and Sundance Trail will be gated in accordance with the following:

Echo Lane Access: The two entries on Echo Lane will have divided access, with separate gates for ingress and egress to the development. The gates will be constructed of decorative wrought iron or similar material, and will open to provide unobstructed ingress or egress. Each entry or exit lane will have a minimum unobstructed width of fifteen (15) feet. The gates will be equipped with a telephone entry system to allow visitors to obtain access.

Sundance Trail Emergency Access: The secondary access between Road “A” and Sundance Trail will be an undivided access road, with a single gate for both travel lanes. This road will be used for emergency access only. The access road will have a minimum unobstructed width of twenty (20) feet. The gate will be constructed of decorative wrought iron or similar material, and will open to provide unobstructed access for emergency vehicles and the evacuation of civilians.

Emergency Access: To permit unobstructed access for emergency vehicles and provide for evacuation of residents within the development and in surrounding neighborhoods, an emergency access system shall be developed in consultation with the Diamond Springs-El Dorado Fire Protection District. The system, which shall be reviewed and approved by the Fire District prior to issuance of a building permit for the 25th lot, will provide for all automatic gates to be equipped with one or more of the following emergency access devices:

1. A “Knox” emergency access device consisting of a key activated switch acceptable to the Fire District.
2. A 3M Opticom Control device and a linear receiver device to allow remote activation by emergency vehicles.
3. Designed to automatically open and remain in a fully opened position during a power failure.
4. A mechanical release.
5. A telephone entry access system that will permit the Fire District or other emergency dispatch center to open the gate from a remote location.

A loop system will be located on the inside portion of the access roadway or lane at the intersection of Road "A"/Echo Lane and Road "B"/Echo Lane to permit vehicular traffic within the gated area to open the gate and exit. The loop system will keep the gate open as long as vehicular traffic is passing through.

All gates and access roads will be maintained by the Homeowners Association or other entity formed for this purpose.

Staff Verification: This condition does not apply to this Large Lot Final Map. This Large Lot Final Map is proposed for financing purposes only. Conformance with this condition will be required for all future small lot Final Maps.

35. All roadways and driveways shall adhere to El Dorado County Department of Transportation (DOT) requirements.

Staff Verification: This condition does not apply to this Large Lot Final Map. This Large Lot Final Map is proposed for financing purposes only. Conformance with this condition will be required for all future small lot Final Maps.

36. A Fire Safe Plan shall be designed for this subdivision by a Registered Professional Forester or a Fire District approved Fire Safe Planner, per California Department of Forestry State Responsibility Area (SRA) Fire Safe Regulations. The purpose is to reduce the intensity of a wildfire by reducing the volume and density of flammable vegetation, the strategic setting of fuel modification and greenbelt shall provide:
- a. Increased safety for emergency fire equipment, personnel and the evacuation of civilians.
 - b. A point of attack or defense from a wildfire.
 - c. CAL FIRE requires a Wildland Fire Safe Plan be developed by a qualified consultant to address mitigations that need to be developed to ensure that the safety of the public and firefighters who may be called upon to respond to wildland fires and other emergencies within the project area.

Staff Verification: This condition does not apply to this Large Lot Final Map. This Large Lot Final Map is proposed for financing purposes only. Conformance with this condition will be required for all future small lot Final Maps.

37. Disposal, including chipping, burying, burning or removal to a landfill site approved by the local jurisdiction, of flammable vegetation and fuels caused by site development and construction, road and driveway construction, and fuel modification shall be completed prior to completion of road construction or final inspection of a building permit.

Staff Verification: This condition does not apply to this Large Lot Final Map. This Large Lot Final Map is proposed for financing purposes only. Conformance with this condition will be required for all future small lot Final Maps.

38. Subdivision and other developments, which propose greenbelt as a part of the development plan, shall locate said greenbelt strategically, as a separation between wildland fuels and structures. The locations shall be approved by the inspection.

Staff Verification: This condition does not apply to this Large Lot Final Map. This Large Lot Final Map is proposed for financing purposes only. Conformance with this condition will be required for all future small lot Final Maps.

39. Approval of subject project is conditioned on meeting the public safety and fire protection requirements of the County of El Dorado General Plan, which shall include provision of a financing mechanism for said services¹. The financing mechanism shall include inclusion within, or annexation into, a Community Facilities District (CFD) established under the Mello-Roos Community Facilities Act of 1982 (Government Code § 53311 et seq.), established by the Diamond Springs / El Dorado Fire Protection District (District) for the provision of public services permitted under Government Code § 53313, including fire suppression services, emergency medical services, fire prevention activities and other services (collectively Public Services), for which proceedings are under consideration, and as such, shall be subject to the special tax approved with the formation of such CFD with the Tract's inclusion or annexation into the CFD.

Staff Verification: This condition does not apply to this Large Lot Final Map. This Large Lot Final Map is proposed for financing purposes only. Conformance with this condition will be required for all future small lot Final Maps.

40. All parcels one acre and larger shall provide a minimum 30-foot setback for buildings and accessory buildings from all property lines and/or the center of the road (Article 5. Fuel Modification Standards, Section 1276.01(a) of the Fire Safe Regulations).

Staff Verification: This condition does not apply to this Large Lot Final Map. This Large Lot Final Map is proposed for financing purposes only. Conformance with this condition will be required for all future small lot Final Maps.

Cal Fire

41. Total roadway width in the project area should meet DOT standards.

Staff Verification: This condition does not apply to this Large Lot Final Map. This Large Lot Final Map is proposed for financing purposes only. Conformance with this condition will be required for all future small lot Final Maps.

42. Roads shall be constructed with an approved driving surface capable of supporting the imposed load of fire apparatus weighing at least 75,000 pounds (2007 California Fire Code, Appendix D).

Staff Verification: This condition does not apply to this Large Lot Final Map. This Large Lot Final Map is proposed for financing purposes only. Conformance with this condition will be required for all future small lot Final Maps.

43. **Secondary Access:** The Design Improvements Standards Manual (DISM) Section 3.A.9 requires at least two connections with an existing, improved public street, or with a future street connection approved by the Planning Commission or the Board. Both the primary and secondary accesses must be to through roads (i.e., they cannot both tie into the same dead end road) and they must meet County standards.

Staff Verification: This condition does not apply to this Large Lot Final Map. This Large Lot Final Map is proposed for financing purposes only. Conformance with this condition will be required for all future small lot Final Maps.

44. The two points of acceptable access and egress in this case would be off of Sundance Trail and Echo Lane.

Staff Verification: This condition does not apply to this Large Lot Final Map. This Large Lot Final Map is proposed for financing purposes only. Conformance with this condition will be required for all future small lot Final Maps.

El Dorado County Department of Transportation

PROJECT SPECIFIC CONDITIONS:

45. **Road Design Standards:** The applicant shall construct all roads in conformance with the Design and Improvements Standard Manual (DISM), as shown in Table 1. The improvements shall be completed to the satisfaction of the Department of Transportation (DOT) or the applicant shall obtain an approved improvement agreement with security, prior to the filing of the final map: (the requirements outlined in Table 1 are minimums)

Table 1					
ROAD NAME	DESIGN STANDARD PLAN	ROAD WIDTH* / SHOULDER WIDTH	RIGHT OF WAY**	DESIGN SPEED	EXCEPTIONS/ NOTES
Road A	Modified Std Plan 101B (3"AC over 8"AB Min.)	24 ft – 20 ft at dam crossing /2)	50ft	25 mph	No curb, gutter, or sidewalk, road width is measured EP to EP. Modified width due to existing constraints. No parking permitted.
Road B, C, D, E, F, G	Modified Std Plan 101B	24ft/2	40ft	25 mph	No curb, gutter, or sidewalk, road

	(3"AC over 8"AB Min.)				width is measured EP to EP. No parking permitted.
Echo Lane Offsite (onsite)	Modified Std Plan 101B (3"AC over 8"AB Min.)	28ft	60ft	25 mph	No curb, gutter, or sidewalk, road width is measured EP to EP. Improvements shall be from Road "A" to El Dorado Road

* Road widths are measured from curb face to curb face or edge of pavement to edge of pavement if no curb (traveled way). Curb face for rolled curb and gutter is 6" from the back of the curb.

** Non-exclusive road and public utility easements included

Staff Verification: This condition does not apply to this Large Lot Final Map. This Large Lot Final Map is proposed for financing purposes only. Conformance with this condition will be required for all future small lot Final Maps.

46. **Road & Public Utility Easements:** The applicant shall provide a 50-foot wide non-exclusive road and public utility easement for the on-site access roadways Road A, Road B, Road C, Road D, Road E, Road F, and Road G prior to the filing of the final map. Slope easements shall be included as necessary.

Staff Verification: This condition does not apply to this Large Lot Final Map. This Large Lot Final Map is proposed for financing purposes only. Conformance with this condition will be required for all future small lot Final Maps.

47. **Encroachment Permit:** The applicant shall obtain an encroachment permit from DOT and shall construct the roadway encroachment(s) from the Road A onto Sundance Trail and Echo Lane to the provisions of County Design Std **103D**, or as required by the approved traffic study. The improvements shall be completed to the satisfaction of the Department of Transportation or the applicant shall obtain an approved improvement agreement with security, prior to the filing of the final map.

Staff Verification: This condition does not apply to this Large Lot Final Map. This Large Lot Final Map is proposed for financing purposes only. Conformance with this condition will be required for all future small lot Final Maps.

48. **Dead End Roads:** Pursuant to Article 2, Section 1273.09 of the SRA Fire Safe Regulations, the maximum length of a dead-end road, including all dead-end roads accessed from the dead-end road, shall not exceed the following cumulative lengths, regardless of the numbers of parcels served:

- parcels zoned for less than one acre-----800 feet

- parcels zoned for 1 acre to 4.99 acres-----1,320 feet
- parcels zoned for 5 acres to 19.99 acres -----2,640 feet
- parcels zoned for 20 acres or larger -----5,280 feet

All lengths shall be measured from the edge of the roadway surface at the intersection beginning the road to the end of the road at its farthest point. Where a dead-end road crosses areas of differing zoned parcel sizes, requiring different length limits, the shortest allowable length shall apply. The lengths of all dead-end roads shall be graphically depicted and identified on the site and improvements plans prior to the filing of the map.

Staff Verification: This condition does not apply to this Large Lot Final Map. This Large Lot Final Map is proposed for financing purposes only. Conformance with this condition will be required for all future small lot Final Maps.

49. **Turnaround:** The applicant shall provide a turn around at the end of the roadways to the provisions of County Standard Plan 114 or approved equivalent. The improvements shall be completed to the satisfaction of the Department of Transportation or the applicant shall obtain an approved improvement agreement with security, prior to the filing of the final map.

Staff Verification: This condition does not apply to this Large Lot Final Map. This Large Lot Final Map is proposed for financing purposes only. Conformance with this condition will be required for all future small lot Final Maps.

50. **Tangents:** Pursuant to DISM Sec 3.B.6, a minimum 100-ft tangent shall be introduced between reversed curves. The County Engineer may approve a tangent of less than 100-ft on local roads provided the adjacent curves have a minimum radius of 200-ft or an acceptable alternative approved by the County Engineer. The tangent and radius lengths shall be graphically depicted on the site plans or included in a Line & Curve Table on the site plans prior to filing of the final map.

Staff Verification: This condition does not apply to this Large Lot Final Map. This Large Lot Final Map is proposed for financing purposes only. Conformance with this condition will be required for all future small lot Final Maps.

51. **Minimum Radius:** Pursuant to Section 3.B.7. of the DISM, the minimum centerline curve radius length of subdivision streets shall be 100 feet for local streets and 300 feet for minor collecting streets. The improvements shall be substantially completed, to the approval of the Department of Transportation or the applicant shall obtain an approved improvement agreement with security, prior to the filing of the final map.

52. **Cut Slopes:** Per the El Dorado County Grading Design Manual Sec B.6, the top of cut slopes shall not be made nearer a permit area boundary line than one fifth the vertical height of cut with a minimum of two (2) feet and a maximum of ten (10) feet. The improvements shall be substantially completed, to the approval of the Department of Transportation or the applicant shall obtain an approved improvement agreement with security, prior to the filing of the final map.

Staff Verification: This condition does not apply to this Large Lot Final Map. This Large Lot Final Map is proposed for financing purposes only. Conformance with this condition will be required for all future small lot Final Maps.

53. **Fill Slopes:** Per the El Dorado County Grading Design Manual Sec B.6, the toe of the fill slope shall not be made nearer to the permit area boundary line than one half the height of the slope with a minimum of two (2) feet and a maximum of twenty (20) feet. Where a fill slope is to be located near the permit area boundary and the adjacent off-site property is developed, special precautions shall be incorporated in the work as the building official deems necessary to protect the adjoining property from damage as a result of such grading. The improvements shall be substantially completed, to the approval of the Department of Transportation or the applicant shall obtain an approved improvement agreement with security, prior to the filing of the final map.

Staff Verification: This condition does not apply to this Large Lot Final Map. This Large Lot Final Map is proposed for financing purposes only. Conformance with this condition will be required for all future small lot Final Maps.

54. **Off-site Easements:** Applicant shall provide all necessary recorded easements for the drainage, slope and road improvements crossing the property line prior to approval of the improvement plans.

Staff Verification: This condition does not apply to this Large Lot Final Map. This Large Lot Final Map is proposed for financing purposes only. Conformance with this condition will be required for all future small lot Final Maps.

55. **Off-site Access Easements:** The applicant shall provide proof of access to the project site from a State or County maintained road. Said proof shall be provided by and through a "Parcel Map Guarantee" which shall be submitted to the County Surveyor's Office with the first map check for the map.

Staff Verification: This condition does not apply to this Large Lot Final Map. This Large Lot Final Map is proposed for financing purposes only. Conformance with this condition will be required for all future small lot Final Maps.

56. **Driveway Cuts:** Subdivision improvements shall include rough grading of driveways for all lots with street cuts or fills along the frontage of six feet or more difference in elevation, or as found necessary for reasonable access by the County Engineer. Construction of said driveways shall conform to the Design and Improvements Standards Manual and the Encroachment Ordinance. Attention should be given to the minimum required sight distance at all driveway encroachments. As an alternative, a Notice of Restriction shall be filed against all downhill lots with fill in excess of 6 feet which allows structural driveway access only.

Staff Verification: This condition does not apply to this Large Lot Final Map. This Large Lot Final Map is proposed for financing purposes only. Conformance with this condition will be required for all future small lot Final Maps.

DOT STANDARD CONDITIONS

57. **Easements:** All applicable existing and proposed easements shall be shown on the project plans.

Staff Verification: This condition does not apply to this Large Lot Final Map. This Large Lot Final Map is proposed for financing purposes only. Conformance with this condition will be required for all future small lot Final Maps.

58. **Signage:** The applicant shall install all necessary signage such as stop signs, street name signs, and/or "not a county maintained road" road sign as required by the Department of Transportation prior to the filing of the map. The signing and striping shall be designed and constructed per the latest version of the Manual Uniform Traffic Control Devices (MUTCD) and the California Supplement.

Staff Verification: This condition does not apply to this Large Lot Final Map. This Large Lot Final Map is proposed for financing purposes only. Conformance with this condition will be required for all future small lot Final Maps.

59. **Maintenance Entity:** The proposed project must form an entity for the maintenance of any shared or common: private roads, parking facilities, landscaping, signs and drainage facilities. If there is an existing entity, the property owner shall modify the document if the current document does not sufficiently address maintenance of the roads, parking facilities, landscaping, signs, and drainage facilities of the current project. DOT shall review the document forming the entity to ensure the provisions are adequate prior to filing of the final map.

Staff Verification: This condition does not apply to this Large Lot Final Map. This Large Lot Final Map is proposed for financing purposes only. Conformance with this condition will be required for all future small lot Final Maps.

60. **Common Fence/Wall Maintenance:** The responsibility for, and access rights for, maintenance of any fences and walls constructed on property lines shall be included in the Covenants Codes and Restrictions (CC&Rs).

Staff Verification: This condition does not apply to this Large Lot Final Map. This Large Lot Final Map is proposed for financing purposes only. Conformance with this condition will be required for all future small lot Final Maps.

61. **Water Quality Stamp:** All new or reconstructed drainage inlets shall have a storm water quality message stamped into the concrete, conforming to the Storm Water Quality

Design Manual for the Sacramento and South Placer Regions, Chapter 4, Fact Sheet SD-1. All stamps shall be approved by the El Dorado County inspector prior to being used.

Staff Verification: This condition does not apply to this Large Lot Final Map. This Large Lot Final Map is proposed for financing purposes only. Conformance with this condition will be required for all future small lot Final Maps.

62. **DISM Consistency:** The developer shall obtain approval of project improvement plans and cost estimates consistent with the Subdivision Design and Improvement Standards Manual from the County Department of Transportation, and pay all applicable fees prior to filing of the final map.

Staff Verification: This condition does not apply to this Large Lot Final Map. This Large Lot Final Map is proposed for financing purposes only. Conformance with this condition will be required for all future small lot Final Maps.

63. **Road Improvement Agreement & Security:** The developer shall enter into a Road Improvement Agreement (RIA) with the Department of Transportation for all roadway, frontage, and intersection improvements. The developer shall complete the improvements to the satisfaction of DOT or provide security to guarantee performance of the RIA as set forth within the County of El Dorado Subdivision Division Ordinance, prior to filing of the final map.

Staff Verification: This condition does not apply to this Large Lot Final Map. This Large Lot Final Map is proposed for financing purposes only. Conformance with this condition will be required for all future small lot Final Maps.

64. **Import/Export Grading Permit:** Any import, or export to be deposited or borrowed within El Dorado County, shall require an additional grading permit for that offsite grading.

Staff Verification: This condition does not apply to this Large Lot Final Map. This Large Lot Final Map is proposed for financing purposes only. Conformance with this condition will be required for all future small lot Final Maps.

65. **Grading Permit / Plan:** The applicant shall submit a improvement/grading plan for onsite and offsite improvements prepared by a professional civil engineer to the Department of Transportation for review and approval. The plan shall be in conformance with the County of El Dorado “*Design and Improvement Standards Manual*”, the “*Grading, Erosion and Sediment Control Ordinance*”, the “*Drainage Manual*”, the “*Off-Street Parking and Loading Ordinance*”, and the State of California Handicapped Accessibility Standards. All applicable plan check and inspection fees shall be paid at the time of submittal of improvement plans. The improvements and grading shall be completed to the satisfaction of the DOT or the applicant shall obtain an approved improvement agreement with security, prior to the filing of the final map.

Staff Verification: This condition does not apply to this Large Lot Final Map. This Large Lot Final Map is proposed for financing purposes only. Conformance with this condition will be required for all future small lot Final Maps.

66. **Grading Plan Review:** Grading and improvement plans shall be prepared and submitted to the El Dorado County Resource Conservation District (RCD) and the Department of Transportation. The RCD shall review and make appropriate recommendations to the County. Upon receipt of the review report by the RCD, the Department of Transportation shall consider imposition of appropriate conditions for reducing or mitigating erosion and sedimentation from the project. Grading plans shall incorporate appropriate erosion control measures as provided in the El Dorado County Grading Ordinance and El Dorado County Storm Water Management Plan. Appropriate runoff controls such as berms, storm gates, detention basins, overflow collection areas, filtration systems, and sediment traps shall be implemented to control siltation, and the potential discharge of pollutants into drainages.

Staff Verification: This condition does not apply to this Large Lot Final Map. This Large Lot Final Map is proposed for financing purposes only. Conformance with this condition will be required for all future small lot Final Maps.

67. **RCD Coordination:** The timing of construction and method of revegetation shall be coordinated with the El Dorado County Resource Conservation District (RCD). If grading activities are not completed by September, the developer shall implement a temporary grading and erosion control plan. Such temporary plans shall be submitted to the RCD for review and recommendation to the Department of Transportation. The Department of Transportation shall approve or conditionally approve such plans and cause the developer to implement said plan on or before October 15.

Staff Verification: This condition does not apply to this Large Lot Final Map. This Large Lot Final Map is proposed for financing purposes only. Conformance with this condition will be required for all future small lot Final Maps.

68. **Soils Report:** At the time of the submittal of the grading or improvement plans, the applicant shall submit a soils and geologic hazards report (meeting the requirements for such reports provided in the El Dorado County Grading Ordinance) to, and receive approval from the El Dorado County Department of Transportation. Grading design plans shall incorporate the findings of detailed geologic and geotechnical investigations and address, at a minimum, grading practices, compaction, slope stability of existing and proposed cuts and fills, erosion potential, ground water, pavement section based on TI and R values, and recommended design criteria for any retaining walls.

Staff Verification: This condition does not apply to this Large Lot Final Map. This Large Lot Final Map is proposed for financing purposes only. Conformance with this condition will be required for all future small lot Final Maps.

69. **Drainage Study / SWMP Compliance:** The applicant shall provide a drainage report at time of improvement plans or grading permit application, consistent with the Drainage

Manual and the Storm Water Management Plan, which addresses storm water runoff increase, impacts to downstream facilities and properties, and identification of appropriate storm water quality management practices to the satisfaction of the Department of Transportation.

The Drainage Study must demonstrate the subject property has adequate existing and proposed storm drainage facilities. At a minimum, the drainage study, plans, and calculations shall include the following:

- The site can be adequately drained;
- The development of the site will not cause problems to nearby properties, particularly downstream sites;
- The on-site drainage will be controlled in such a manner as to not increase the downstream peak flow more than the pre-development 10-year storm event or cause a hazard or public nuisance. Detention shall be required if said condition is not met or demonstrate that there are no downstream impacts.
- The ultimate drainage outfall of the project.

Pursuant to Section 1.8.3 of the Drainage Manual, the report shall be prepared by a Civil Engineer who is registered in the State of California. The improvements shall be completed to the approval of the Department of Transportation, prior to the filing of the final map or the applicant shall obtain an approved improvement agreement with security.

Staff Verification: This condition does not apply to this Large Lot Final Map. This Large Lot Final Map is proposed for financing purposes only. Conformance with this condition will be required for all future small lot Final Maps.

70. **Drainage (Cross-Lot):** Cross lot drainage shall be avoided. When concentrated cross lot drainage does occur or when the natural sheet flow drainage is increased by the project, it shall be contained within dedicated drainage easements, and included in the County Service Area Zone of Benefit (ZOB), Home Owners Association, or other entity acceptable to the County. Any variations shall be approved by the County Engineer. This drainage shall be conveyed via closed conduit or v-ditch, to either a natural drainage course of adequate size or an appropriately sized storm drain system within the public roadway. The site plans shall show drainage easements for all on-site drainage facilities. Drainage easements shall be provided where deemed necessary prior to the filing of the final map.

Staff Verification: This condition does not apply to this Large Lot Final Map. This Large Lot Final Map is proposed for financing purposes only. Conformance with this condition will be required for all future small lot Final Maps.

71. **Drainage Easements:** Pursuant to Section 4.D of the DISM, the site plans shall show drainage easements for all on-site drainage courses and facilities and shall be included on all improvement plans and the final map.

Staff Verification: This condition does not apply to this Large Lot Final Map. This Large Lot Final Map is proposed for financing purposes only. Conformance with this condition will be required for all future small lot Final Maps

72. **NPDES Permit:** At the time that an application is submitted for improvement plans or a grading permit, and if the proposed project disturbs more than one acre of land area (43,560 square feet), the applicant shall file a “Notice of Intent” (NOI) to comply with the Statewide General NPDES Permit for storm water discharges associated with construction activity with the State Water Resources Control Board (SWRCB). This condition is mandated by the Federal Clean Water Act and the California Water Code. A filing form, a filing fee, a location map, and a Storm Water Pollution Prevention Plan (SWPPP) are required for this filing. A copy of the Application shall be submitted to the County, prior to building permit issuance, and by state law must be done prior to commencing construction.

Staff Verification: This condition does not apply to this Large Lot Final Map. This Large Lot Final Map is proposed for financing purposes only. Conformance with this condition will be required for all future small lot Final Maps.

73. **Off-site Improvements (Security):** Prior to the filing of a final map, the applicant shall complete or enter into an agreement pursuant to Government Code Section 66462.5 to complete the required offsite improvements, including the full costs of acquiring any real property interests necessary to complete the required improvements. In addition to the agreement, the applicant shall provide a cash deposit, letter of credit, or other acceptable surety in the amount sufficient to pay such costs, including legal costs, subject to the approval of County Counsel.

Staff Verification: This condition does not apply to this Large Lot Final Map. This Large Lot Final Map is proposed for financing purposes only. Conformance with this condition will be required for all future small lot Final Maps.

74. **Off-site Improvements (Acquisition):** As specified in the Conditions of Approval, the applicant is required to perform off-site improvements. If it is determined that the applicant does not have or cannot secure sufficient title or interest of such lands where said off-site improvements are required, the County may, at the applicant’s expense and within 120 days of filing the final map, acquire by negotiation or commence proceedings to acquire an interest in the land which will permit the improvements to be made, including proceedings for immediate possession of the property. In such cases, prior to filing of any final map, the applicant shall submit the following to the Department of Transportation Right of Way Unit, and enter into an agreement pursuant to Government Code Section 66462.5 and provide acceptable security to complete the offsite improvements, including costs of acquiring real property interest to complete the required improvements, construction surveying, construction management and a 20 percent contingency:

- a. A legal description and plat, of the land necessary to be acquired to complete the offsite improvements, prepared by a civil engineer or land surveyor.

- b. Approved improvement plans and specifications of the required off-site improvements, prepared by a civil engineer.
- c. An appraisal prepared by a certified appraiser of the cost of land necessary to complete the off-site improvements.

In addition to the agreement the applicant shall provide a cash deposit, letter of credit, or other acceptable surety in an amount sufficient to pay such costs including legal costs subject to the approval of County Counsel.

Staff Verification: This condition does not apply to this Large Lot Final Map. This Large Lot Final Map is proposed for financing purposes only. Conformance with this condition will be required for all future small lot Final Maps.

75. **Electronic Documentation:** Upon completion of the improvements required, and prior to acceptance of the improvements by the County, the developer will provide a CD to DOT with the drainage report, structural wall calculations, and geotechnical reports in PDF format and the record drawings in TIF format.

Staff Verification: This condition does not apply to this Large Lot Final Map. This Large Lot Final Map is proposed for financing purposes only. Conformance with this condition will be required for all future small lot Final Maps.

76. **TIM Fees:** The applicant shall pay the traffic impact mitigation fees in effect at the time a building permit is deemed complete.

Staff Verification: This condition does not apply to this Large Lot Final Map. This Large Lot Final Map is proposed for financing purposes only. Conformance with this condition will be required for all future small lot Final Maps.

El Dorado County Surveyor's Office

77. All survey monuments must be set prior to the presentation of the final map to the Board of Supervisors for approval, or the developer shall have surety of work to be done by bond or cash deposit. Verification of set survey monuments, or amount of bond or deposit to be coordinated with the County Surveyors Office.

Staff Verification: Condition Satisfied. A survey monumentation bond for the Large Lot Final Map (Bond No. 4442223) was submitted to the County Surveyor's office on March 9, 2021(Legistar Attachment A), in conformance with this condition.

78. The roads serving the development shall be named by filing a completed Road Name Petition with the County Surveyors Office prior to filing the Final Map.

Staff Verification: This condition does not apply to this Large Lot Final Map. This Large Lot Final Map is proposed for financing purposes only. Conformance with this condition will be required for all future small lot Final Maps.

El Dorado County Environmental Management

Air Quality Management

79. The applicant shall adhere to all District rules and conditions during project construction, as specified by the District in their letter dated September 2, 2008 prior to issuance of any permits associated with this project.

Staff Verification: This condition does not apply to this Large Lot Final Map. This Large Lot Final Map is proposed for financing purposes only. Conformance with this condition will be required for all future small lot Final Maps.

Hazardous Materials

80. If any commercial, industrial, agricultural, mining or any other hazardous materials handling activities have taken place on the property in the past, the applicant must conduct a Phase I Environmental Site Assessment (ESA). The Phase I must be conducted in accordance with ASTM standard E 1527-00. All information developed in the Phase I process must be submitted to the Hazardous Materials Division (HMD) for review. If upon review of the Phase I information, HMD determines the property is a potentially impacted site, the applicant must apply for a permit, submit a workplan and conduct a Phase II ESA and any required site remediation activities prior to developing property.

Staff Verification: This condition does not apply to this Large Lot Final Map. This Large Lot Final Map is proposed for financing purposes only. Conformance with this condition will be required for all future small lot Final Maps.