

**TM17-1532: Sierra Sunrise
Location Map
Exhibit A**

 Sierra Sunrise Project

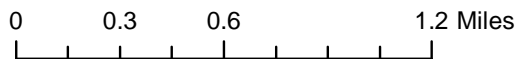

2017 MAY 22 AM 9:25

RECEIVED
PLANNING DEPARTMENT

116:03

POR. SECS. 32 & 33, T.10N., R.9E., M.D.M.

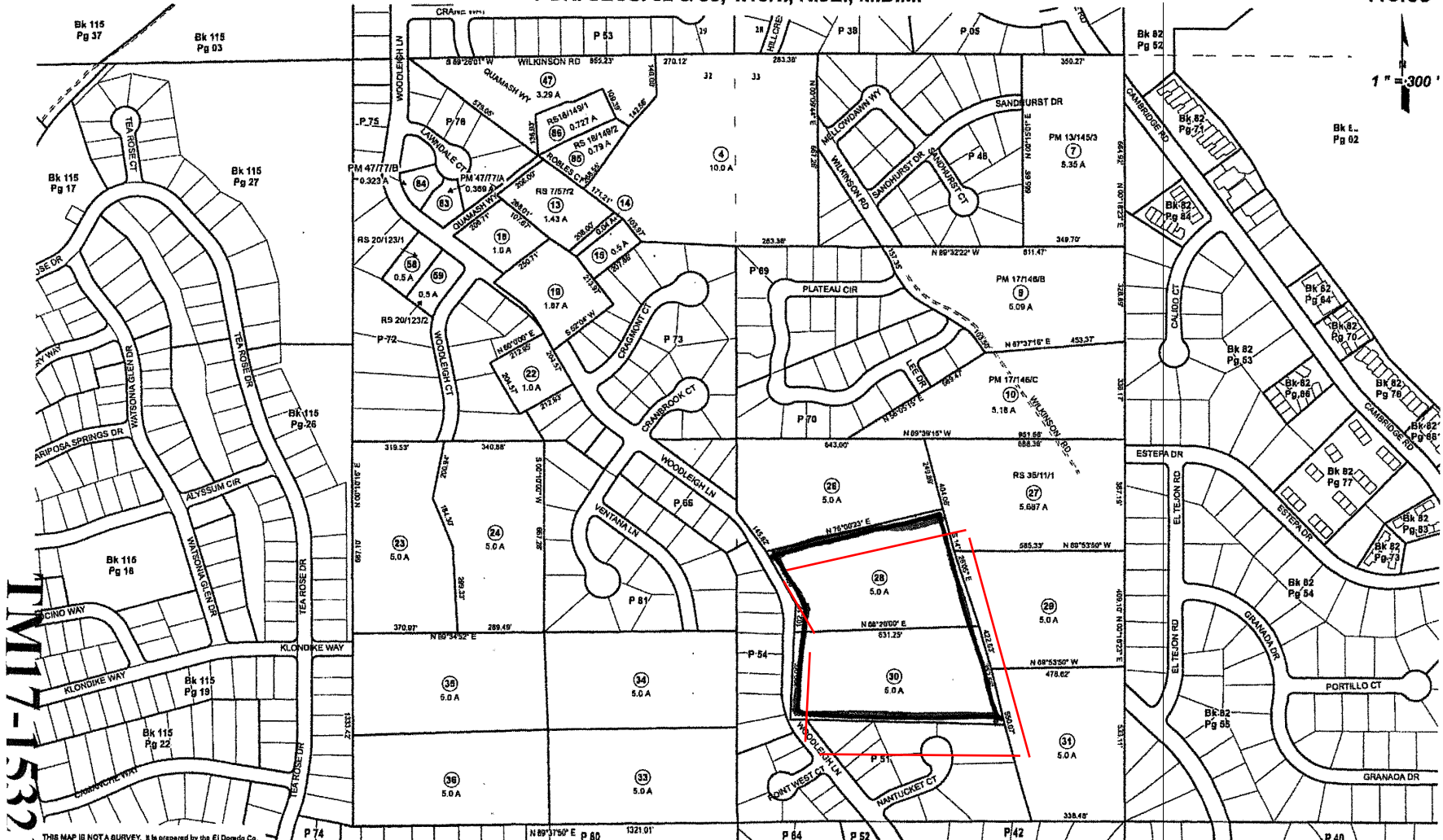
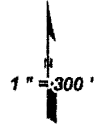

17-153

THIS MAP IS NOT A SURVEY. It is prepared by the El Dorado Co. Assessor's office for assessment purposes only. Area calculations and characteristics are not guaranteed. Users should verify items such as dimensions and acreage.

Acreages Are Estimates

Adjacent Maps Pages Shown in Grey Text
Assessor's Block Numbers Shown in Ellipse
Assessor's Parcel Numbers Shown in Circles

Rev. DEC 28, 2015

Assessor's Map Bk. 116, Pg. 03
County of El Dorado, CA

Exhibit B

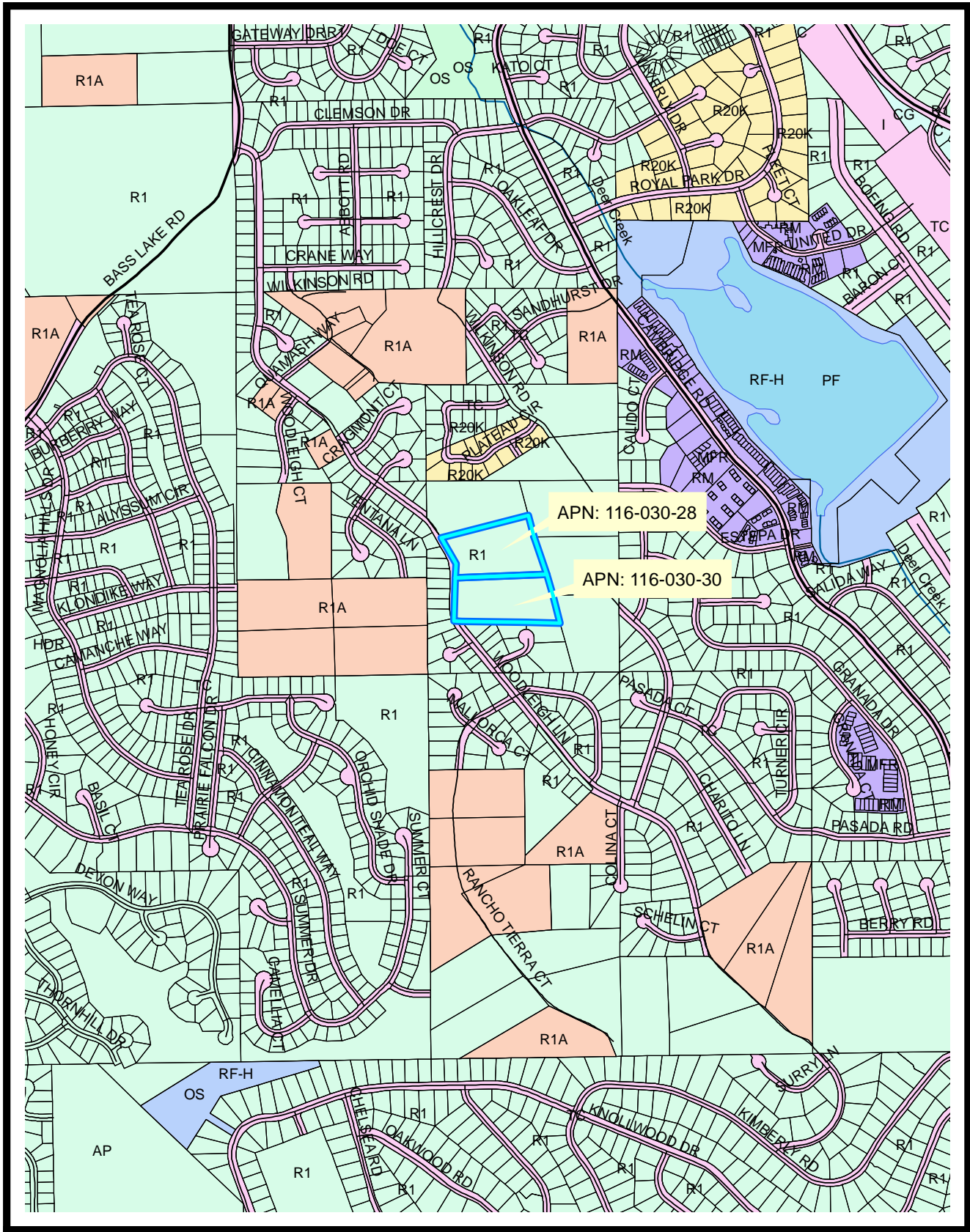

CG	R20K
OS	RF-H
R1	RM
R1A	TC

TM17-1532: Sierra Sunrise
Zoning Map
Exhibit D

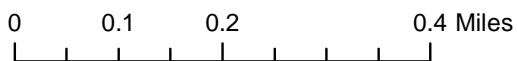



**TM17-1532: Sierra Sunrise
Aerial Map
Exhibit E**

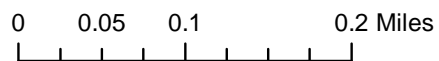

TENTATIVE MAP SIERRA SUNRISE

COUNTY OF EL DORADO MAY, 2017 STATE OF CALIFORNIA

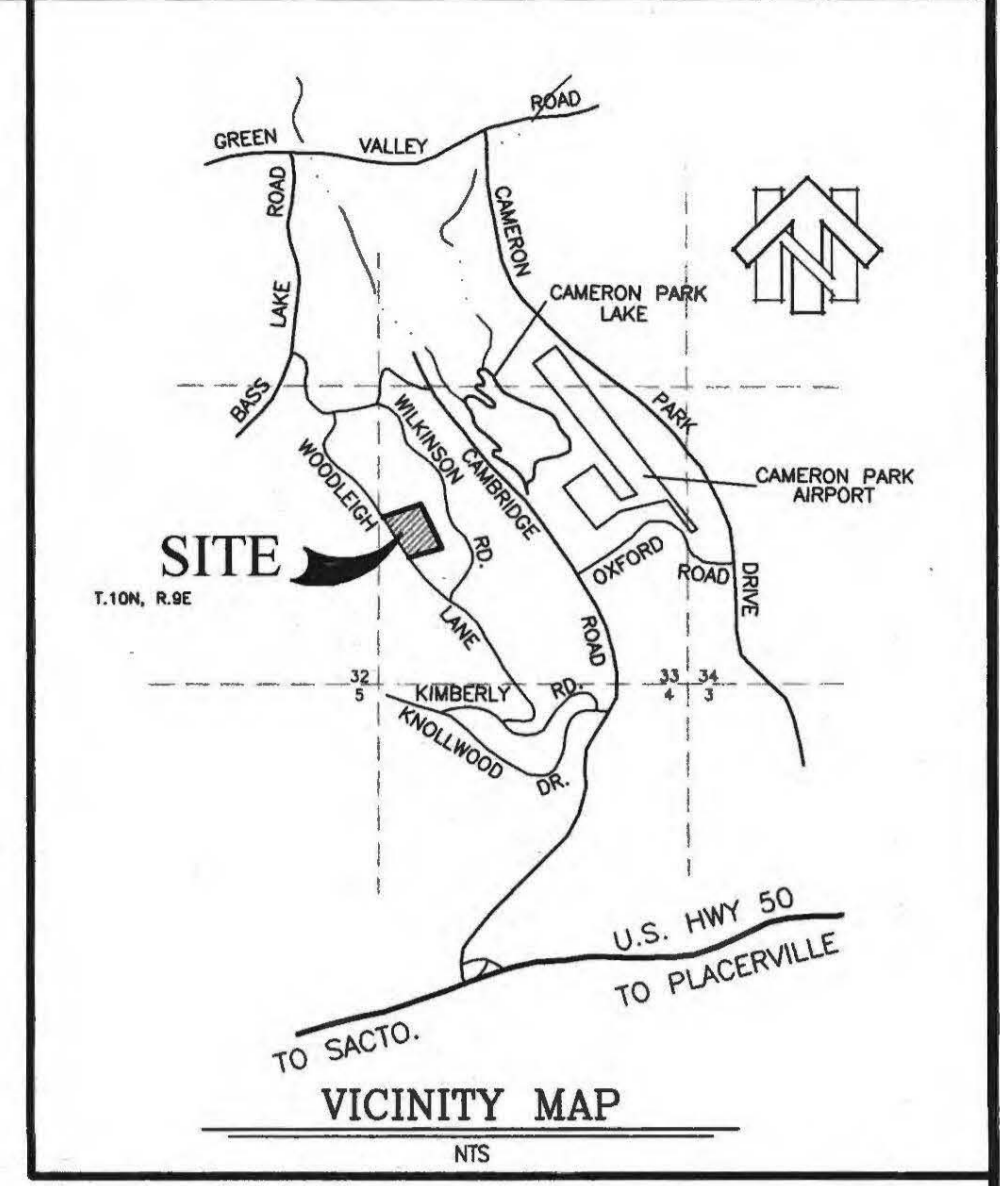

2017 MAY 22 AM 9:30
RECEIVED
PLANNING DEPARTMENT

OWNERS OF RECORD

PACIFIC STATES DEVELOPMENT
991 GOVERNOR DRIVE, SUITE 106
EL DORADO HILLS, CA 95762

APPLICANT

PACIFIC STATES DEVELOPMENT
991 GOVERNOR DRIVE, SUITE 106
EL DORADO HILLS, CA 95762

ENGINEER

cta Engineering & Surveying

Civil Engineering • Land Surveying • Land Planning
3233 Monitor Circle, Rancho Cordova, CA 95742
T (916) 638-0919 • F (916) 638-2479 • www.cta.com

LEGEND

- SUBDIVISION BOUNDARY
- LOT LINE
- (E) EASEMENT
- PROPOSED EASEMENT
- (E) LOT LINES
- (E) RW
- (E) PIPE
- (E) FIRE HYDRANT
- TREES

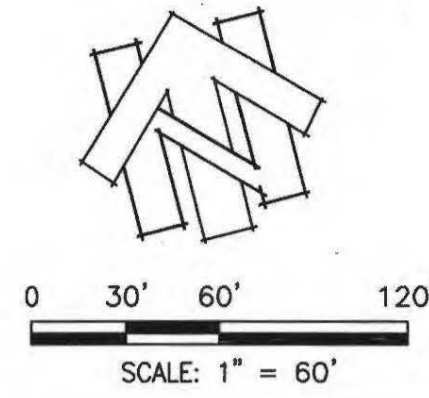

MAP SCALE

1" = 60'

CONTOUR INTERVAL

CONTOUR INTERVAL = 2 FEET

SOURCE OF TOPOGRAPHY

AERIAL PHOTOGRAPHY

SECTION, TOWNSHIP and RANGE

SECTIONS 32, T. 10 N., R. 9 E. M.D.M.

ASSESSOR'S PARCEL NUMBERS

116-030-028
116-030-030

PROPOSED ZONING

R1

PRESENT ZONING

R1

TOTAL AREA

10.00 ACRES

TOTAL NUMBER OF PARCELS

8 - RESIDENTIAL LOTS
1 - ROADWAY LOT
9 - LOTS TOTAL

MINIMUM LOT AREA

17,329 SQUARE FEET

WATER SUPPLY and SEWAGE DISPOSAL

EL DORADO IRRIGATION DISTRICT

PROPOSED STRUCTURAL FIRE PROTECTION

CAMERON PARK CSD (FIRE DEPARTMENT)

DATE OF PREPARATION

MAY, 2017

PHASING PLAN NOTICE

THE SUBDIVIDER MAY FILE MULTIPLE FINAL MAPS FOR THIS PROJECT. THE SUBDIVIDER SHALL NOT BE REQUIRED TO DEFINE THE NUMBER OR CONFIGURATION OF THE PROPOSED MULTIPLE FINAL MAPS. (PER THE SUBDIVISION MAP ACT, SECTION 66456.1)

ENGINEER'S CERTIFICATE

I HEREBY CERTIFY THAT TO THE BEST OF MY KNOWLEDGE THE LAND DEVELOPMENT KNOWN AS SIERRA SUNRISE HAS BEEN DESIGNED IN ACCORDANCE WITH THE SPECIFICATIONS AND GUIDELINES ESTABLISHED BY THE COUNTY OF EL DORADO.

ENGINEER'S NAME R.C.E. *3452* DATE 5-16-17

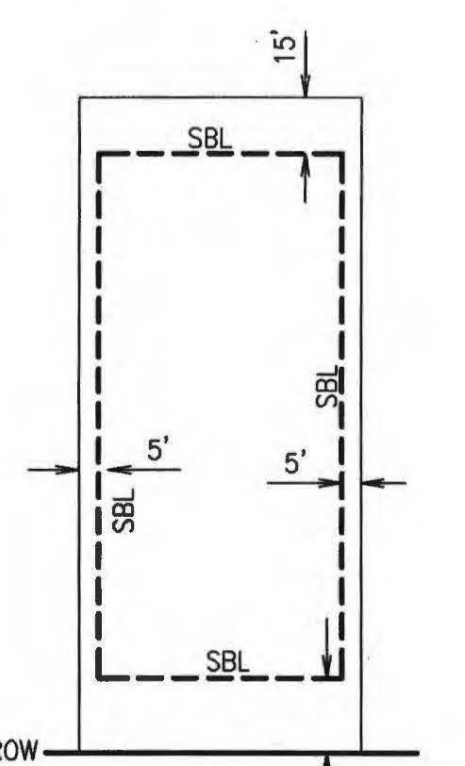
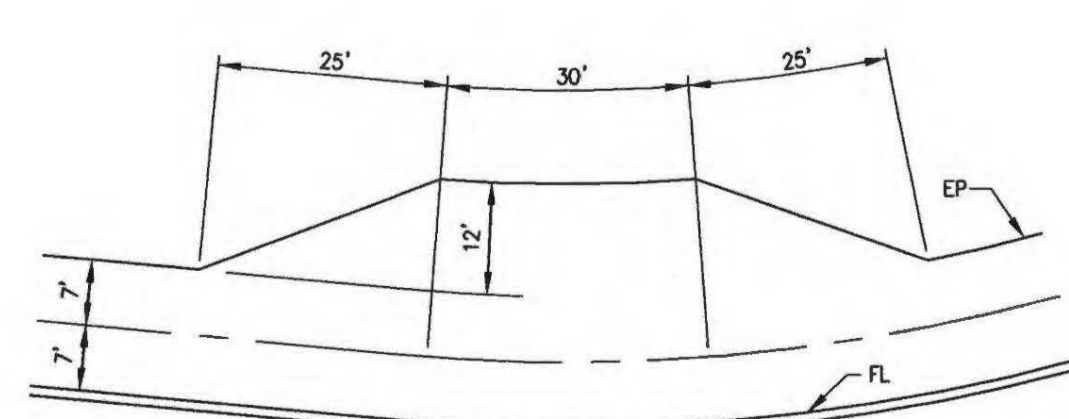
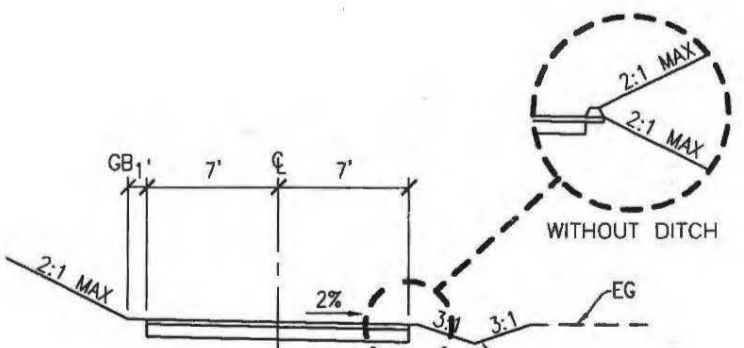
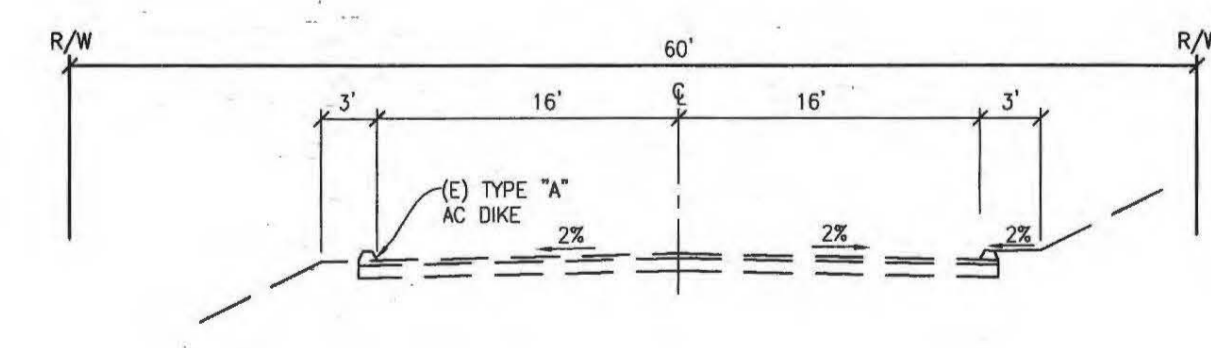
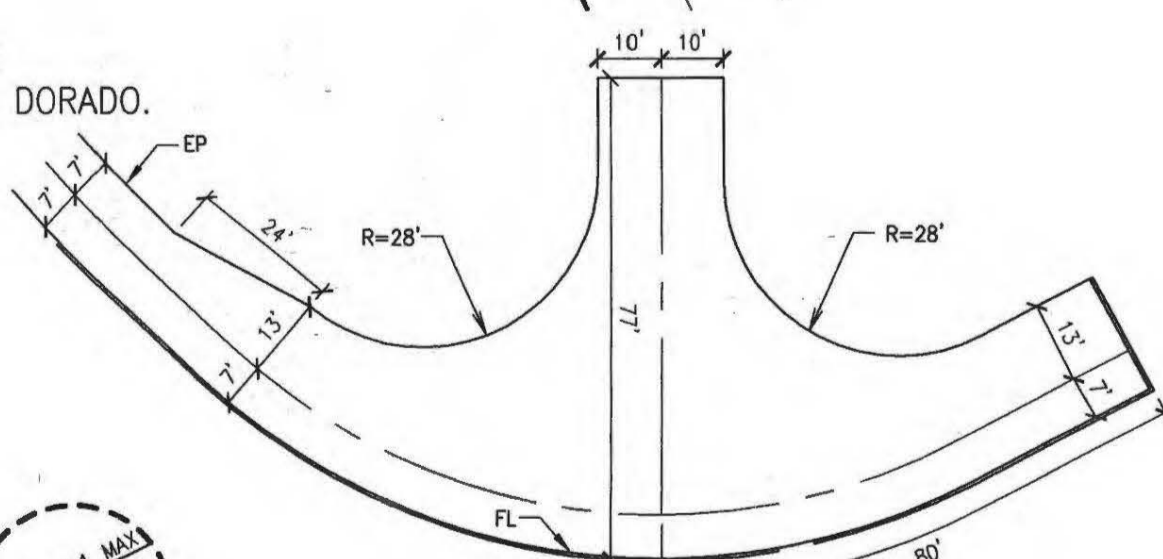

NOTE:
NO IMPROVEMENTS FOR THIS PROJECT NOT WITHSTANDING NECESSARY REPAIRS IN ACCORDANCE WITH EDC STANDARDS.

TM17-1532

PLANNING COMMISSION: _____
APPROVAL/DENIAL DATE: _____

PRELIMINARY GRADING & DRAINAGE PLAN

SIERRA SUNRISE

COUNTY OF EL DORADO

MAY, 2018

STATE OF CALIFORNIA

LEGEND			
	PROPOSED CONTOUR		PROPOSED DRAINAGE SYSTEM
	EXISTING CONTOUR		PROPOSED DITCH
$P=1022.0$	PROPOSED PAD ELEVATION		BUILDING PAD
	2:1 UNLESS OTHERWISE NOTED		PROPOSED DAYLIGHT LINE
	PROPOSED SLOPE BANK		CLASS B LOT (REAR & FRONT DRAINING)

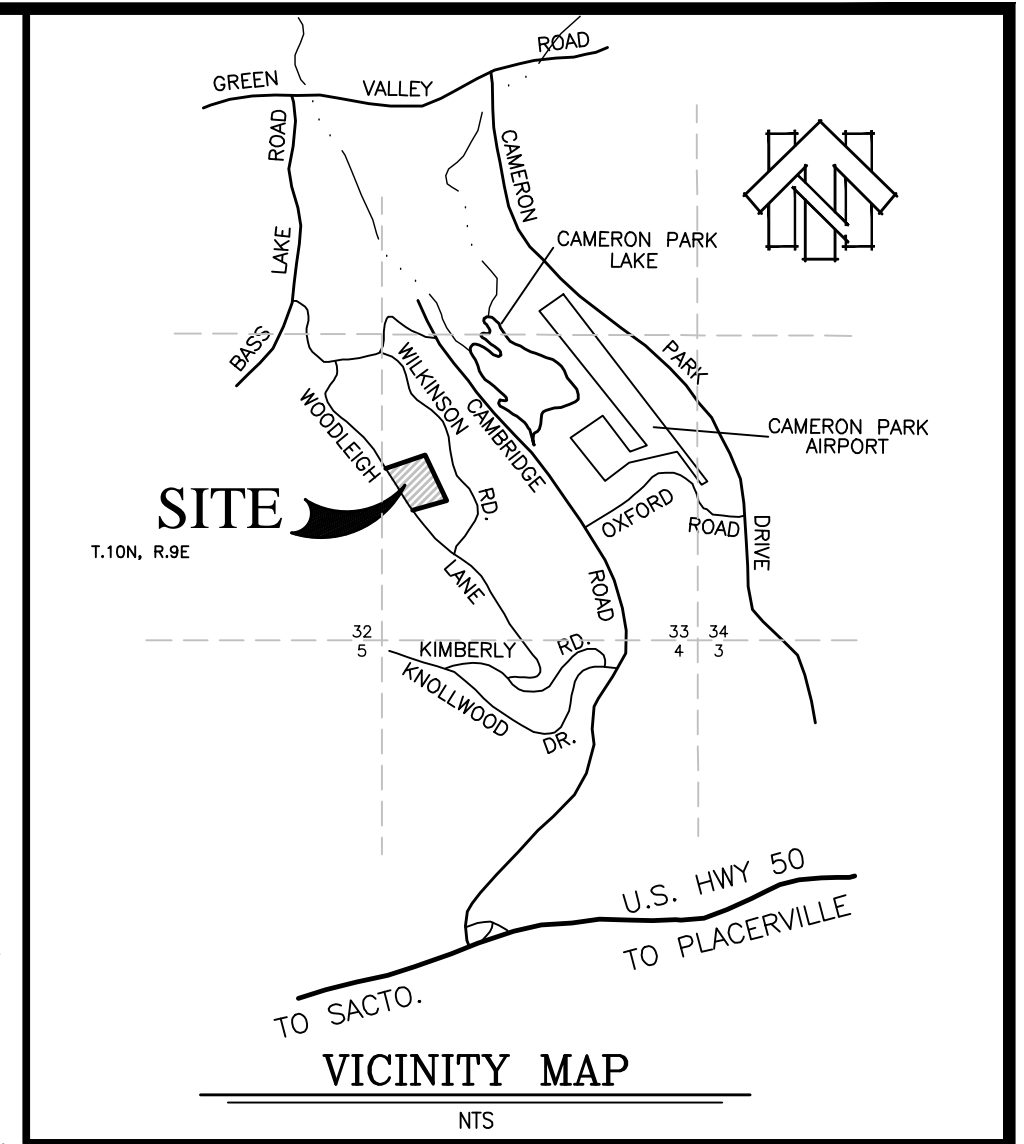

EARTHWORK

EXCAVATION: 24,800 CY ±
EMBANKMENT: 24,800 CY ±

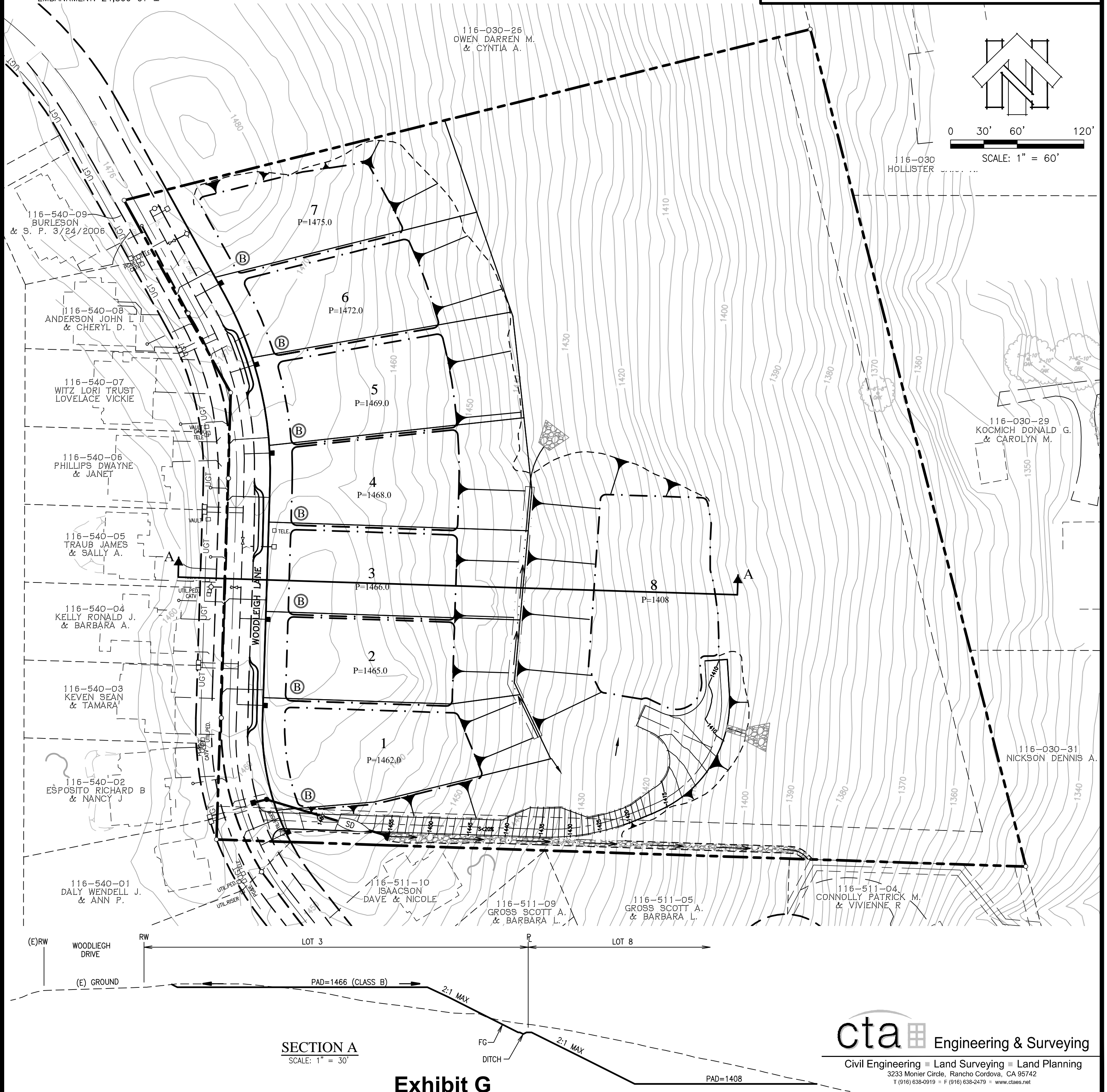

cta Engineering & Surveying
Civil Engineering ■ Land Surveying ■ Land Planning
3233 Monier Circle, Rancho Cordova, CA 95742
T (916) 638-0919 • F (916) 638-2479 • www.ctaes.net

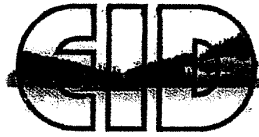

El Dorado Irrigation District

Letter No.: EEO 2016-1275

October 14, 2016

VIA FIRST-CLASS MAIL

Bill Fisher
Pacific States Development
991 Governor Drive, Suite 103
El Dorado Hills, CA 95762

Subject: Facility Improvement Letter (FIL), Sierra Sunrise
Assessor's Parcel No. 116-030-28, 30 (Cameron Park)
EDC Project No: TM 88-1095R

Dear Mr. Fisher:

This letter is in response to your request dated August 31, 2016 and is valid for a period of three years. If facility improvement plans for your project are not submitted to El Dorado Irrigation District (EID or District) within three years of the date of this letter, a new Facility Improvement Letter will be required.

Design drawings for your project must be in conformance with the District's *Water, Sewer and Recycled Water Design and Construction Standards*.

This proposed project is an 18-lot residential subdivision on 10 acres. Water service, sewer service and fire hydrants are requested. The property is within the District boundary.

This letter is not a commitment to serve, but does address the location and approximate capacity of existing facilities that may be available to serve your project.

Water Supply

As of January 1, 2016, there were 12,537 equivalent dwelling units (EDUs) of water supply available in the Western/Eastern Water Supply Region. Your project as proposed on this date would require 16 EDUs of water supply.

Water Facilities

A 12-inch water line exists in Woodleigh Lane (see enclosed System Map). The Cameron Park Fire Department has determined that the minimum fire flow for single family dwellings less than 3,600 square feet is 1,000 GPM for a 2-hour duration while maintaining a 20-psi residual pressure, homes larger than 3,600 square feet will require 1,500 GPM. According to the

2890 Mosquito Road, Placerville CA, 95667 (530) 622-4513

2017 MAY 22 AM 9:25
RECEIVED
PLANNING DEPARTMENT

Exhibit H

TM17-1532

18-1304 D 8 of 40



District's hydraulic model, the existing system can deliver the required fire flow. In order to provide this fire flow and receive service, you must construct a water line extension connecting to the 12-inch waterline located in Woodleigh Lane. The hydraulic grade line for the existing water distribution facilities is 1,575 feet above mean sea level at static conditions and 1,545 feet above mean sea level during fire flow (1,500 GPM) and maximum day demands. The hydraulic grade line for the existing facilities during a 1,000 GPM fire flow is 1,558 feet above mean sea level.

The flow predicted above was developed using a computer model and is not an actual field flow test.

Sewer Facilities

There is a 6-inch sewer line located in Woodleigh Lane. This sewer line has adequate capacity at this time. There are several service stubs to the property along Woodleigh Lane. In order to receive service from this line, an extension of facilities of adequate size must be constructed. Your project as proposed on this date would require 16 EDUs of sewer service.

Easement Requirements

Proposed water lines, sewer lines and related facilities must be located within an easement accessible by conventional maintenance vehicles. When the water lines or sewer lines are within streets, they shall be located within the paved section of the roadway. No structures will be permitted within the easements of any existing or proposed facilities. The District must have unobstructed access to these easements at all times, and generally does not allow water or sewer facilities along lot lines.

Easements for any new District facilities constructed by this project must be granted to the District prior to District approval of water and/or sewer improvement plans, whether on site or off site. In addition, due to either nonexistent or prescriptive easements for some older facilities, any existing onsite District facilities that will remain in place after the development of this property must also have an easement granted to the District.

Environmental

The County is the lead agency for environmental review of this project per Section 15051 of the California Environmental Quality Act Guidelines (CEQA). The County's environmental document should include a review of both offsite and onsite water and sewer facilities that may be constructed by this project. You may be requested to submit a copy of the County's environmental document to the District if your project involves significant off-site facilities. If the County's environmental document does not address all water and sewer facilities and they are not exempt from environmental review, a supplemental environmental document will be



required. This document would be prepared by a consultant. It could require several months to prepare and you would be responsible for its cost.

Summary

Service to this proposed development is contingent upon the following:

- The availability of uncommitted water supplies at the time service is requested;
- Approval of the County's environmental document by the District (if requested);
- Executed grant documents for all required easements;
- Approval of an extension of facilities application by the District;
- Approval of facility improvement plans by the District;
- Construction by the developer of all onsite and offsite proposed water and sewer facilities;
- Acceptance of these facilities by the District; and
- Payment of all District connection costs.

Services shall be provided in accordance with El Dorado Irrigation District Board Policies and Administrative Regulations, as amended from time-to-time. As they relate to conditions of and fees for extension of service, District Administrative Regulations will apply as of the date of a fully executed Extension of Facilities Agreement.

If you have any questions please contact Marc Mackay at (530) 642-4135.

Sincerely,

A handwritten signature in black ink, appearing to read 'M. Brink', written over a horizontal line.

Michael J. Brink, P.E.
Supervising Civil Engineer

MB/MM:at

Enclosures: System Map

Letter No.: EEO 2016-1275
To: Bill Fisher



October 14, 2016
Page 4 of 4

cc w/ System Map:

Michael Smith – Battalion Chief/ Fire Marshal
Cameron Park Fire Department
Via email – mike.smith@fire.ca.gov

Olga Sciorelli, PE
CTA Engineering & Surveying
3233 Monier Circle
Rancho Cordova, CA 95742

Roger Trout, Director
El Dorado County Development Services Department
Via email - roger.trout@edcgov.us

2890 Mosquito Road, Placerville CA, 95667 (530) 622-4513

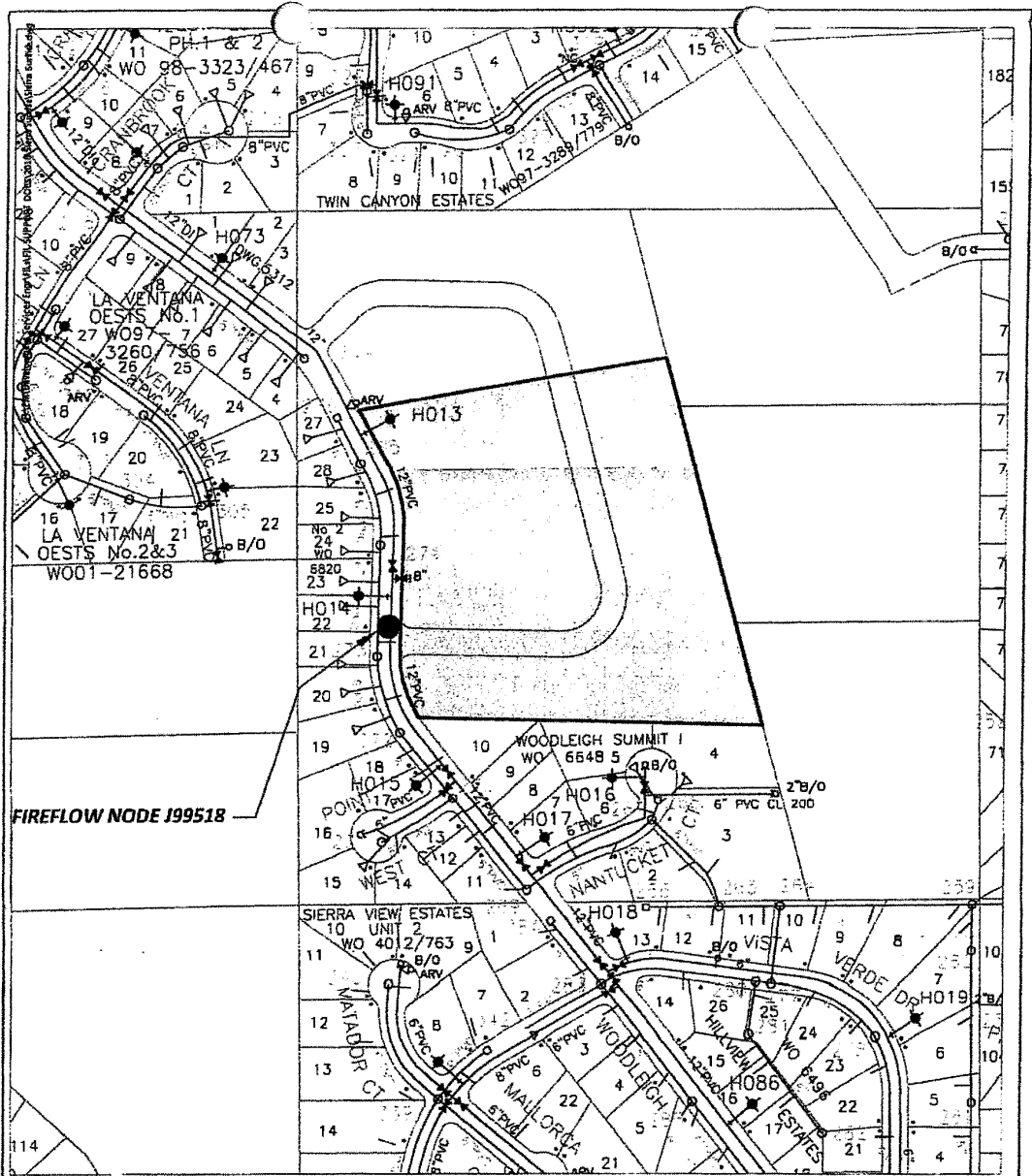

FIREFLOW NODE 199518



Scale: 1" = 250'

El Dorado Irrigation District
System Map

DATE: October 13, 2016

WARNING: For schematic purposes only.
Exact pipe location must be
field verified.

Sierra Sunrise

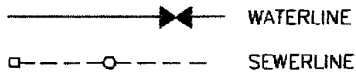

APN: 116-030-28,30

SIERRA SUNRISE DRAINAGE REPORT

Prepared Under the Direction Of:



Prepared: May 2017

cta  Engineering & Surveying
Civil Engineering ■ Land Surveying ■ Land Planning

Exhibit I

TABLE OF CONTENTS

INTRODUCTION 1

PROCEDURES 1

- A. Shed Areas 1
- B. Precipitation..... 1
- C. Times of Concentration..... 2
- D. Soils Report 2
- E. Runoff Coefficients 2
- F. Peak Runoff..... 2
- G. Runoff Hydrographs..... 2

RESULTS AND CONCLUSIONS 2

SHED MAPS

- Pre-Development
- Post-Development
- Regional

APPENDICES

- Appendix A – Precipitation Data
- Appendix B – Excerpts from Soil Resources Report
- Appendix C – Runoff Shed Parameters
- Appendix D – Peak Runoff – On-site
- Appendix E – Regional Runoff

INTRODUCTION

Sierra Sunrise encompasses approximately 10 acres near the western limit of the community of Cameron Park. The site is located south of Green Valley Road between Bass Lake Road and Cambridge Road, on the east side of Woodleigh Lane. At present the study area is vacant land overgrown with native brush and grass. Adjacent land use is single-family residential.

Site topography is defined by a north-south ridgeline that parallels Woodleigh Lane just within the project boundary. A small portion of the site fronting on Woodleigh Lane drains to the west, flowing onto the street as sheet runoff, thence southward in Woodleigh Lane to a rock-lined ditch alongside Nantucket Court. Ditch outflow enters a defined natural channel that originates beyond the southeast property corner and drains towards the east. The drainage system continues eastward through established residential area as a series of unmaintained channel segments and culvert crossings, and ultimately reaches Deer Creek less than 0.4 miles east.

The balance of the site slopes to the east at an average gradient of approximately 20%. Natural runoff crosses the project area as sheet flows and is dispersed along the eastern boundary, continuing as sheet runoff into the existing channel/culvert drainage network. Site runoff converges within the channel system approximately 0.2 miles east of the site at Point A, shown on the Regional Shed Map. The estimated drainage area at this point is approximately 77 acres.

Proposed Sierra Sunrise development will create 7 Class B single-family residential lots averaging 20,000 square feet in area, fronting on Woodleigh Lane. An eighth lot will be accessed from Woodleigh Lane via private driveway, as shown. Drainage improvements will consist of onsite ditches and a single run of storm drain piping.

Sierra Sunrise is subject to the requirements of the NPDES Phase II permit process administered by the State Water Resources Control Board. The project will include site design and hydro-modification measures, to the extent practicable, in compliance with these requirements. Details will be included with project improvement plans

PROCEDURES

The drainage analyses for Sierra Sunrise were carried out in conformance with guidelines and procedures of the *County of El Dorado Drainage Manual*, adopted March 14, 1995.

- A. **SHED AREAS** – Shed areas used in drainage analyses are shown on the enclosed Shed Maps.
- B. **PRECIPITATION** – Precipitation data for Sierra Sunrise are included in Appendix A. Mean annual precipitation for the project area is approximately 29 inches. Corresponding rainfall intensities for durations of 10 through 30 minutes were obtained from the *Drainage Manual*. The 24-hour precipitation totals for storms of 10- and 100-year recurrence intervals are 4.0" and 5.7", respectively.

TABLE 1 - DESIGN RAINFALL INTENSITIES

DURATION (min)	10 YEAR STORM INTENSITY (in/hr)	100 YEAR STORM INTENSITY (in/hr)
10	1.85	2.61
15	1.51	2.15
30	1.08	1.54

- C. **TIMES OF CONCENTRATION** – Times of concentration are summarized in Table B-1 in Appendix B. Travel times were computed for pre- and post-project conditions utilizing Equations 2.4.7 and 2.4.8 from the *Drainage Manual*. A minimum 10-minute time of concentration was used.
- D. **SOILS REPORT** – Excerpts from the Soil Resources Report covering the Sierra Sunrise watershed area are included in Appendix B.
- E. **RUNOFF COEFFICIENTS** – A runoff curve number was assigned to each shed area based on visual apportionment land uses, underlain by soils in hydrologic soil group C, based on the following values from *Drainage Manual* Tables 2-2a & 2-2c.
 Open space – grass cover 50-75% CN = 79
 Open Space – brush-weed-grass mix, good condition CN = 65
 Landscaping – approx. 75% coverage & native vegetation combo CN = 70
 Pavement / impervious – CN=98
 Runoff coefficients used in peak flow computations are derived from C vs CN relationships appended to the *Drainage Manual*.
- F. **PEAK RUNOFF** – Peak on-site runoff values for storms of 10- and 100-year return frequencies were computed utilizing the rational formula $Q=CiA$. In the equation, Q is flow in cfs, C is a non-dimensional runoff coefficient \leq one; i is rainfall intensity in inches per hour associated with the design storm under consideration and the time of runoff concentration of the watershed, and; A is the catchment area, in acres. Input parameters used in the runoff computations are shown in Table C-1, Appendix C.
- G. **RUNOFF HYDROGRAPHS** -The hydrograph method, utilizing the HEC-HMS computer program, was used to estimate pre- and post-project regional runoff at Point A in the offsite drainage system where the entire Sierra Sunrise site contributes. The location of Point A was approximated from topographic information. Flow computations are based on 24-hour precipitation totals temporally distributed as an SCS Type I storm, for 10- and 100-year recurrence intervals. Results are included in Appendix E, and summarized in Table 3.

RESULTS AND CONCLUSIONS

- Please refer to Pre- and Post-Development Shed Maps for shed locations. Runoff from on-site sheds, computed by the peak runoff method, is summarized in Table 2. Details are included in Appendix D. As shown, project development may increase site runoff by less than 1.5 cfs within any given shed during a 100-year event.

TABLE 2 - SITE RUNOFF SUMMARY

SCENARIO	10-YEAR (cfs)				100-YEAR (cfs)			
	Onsite Shed				Onsite Shed			
	A	B	A+B	C	A	B	A+B	C
Pre-Development	1.4	0.6		3.5	2.3	1.3		8.6
Post-Development	2.2	1	3.4	4.6	4.1	1.6	5.9	9.9

- A field reconnaissance of downstream drainage channels and culvert crossings indicates that existing facilities are capable of handling the increased runoff anticipated to result from development of Sierra Sunrise. A more thorough field survey will be performed at the improvement plan stage to validate the preliminary finding. If necessary, project design will include detention storage as a mitigation measure.

- Runoff from Sierra Sunrise converges within the existing channel system approximately 0.2 miles east of the site at Point A, shown on the Regional Shed Map. The estimated drainage area is approximately 77 acres. HEC-HMS was used to estimate regional runoff at Point A under pre- and post-development conditions on the Sierra Sunrise site. Results are summarized in Table 2. Detailed information is included in Appendix D. The effects of the proposed project were found to be minimal when considered within the context of the regional runoff model.

TABLE 3 – REGIONAL RUNOFF SUMMARY: FLOWS AT POINT A

SCENARIO	10-YEAR RUNOFF (cfs)	100-YEAR RUNOFF (cfs)
Pre-Sierra Sunrise	57	109
Post-Sierra Sunrise	58	110

- Improvement plans for Sierra Sunrise will include site design and hydro-modification measures, to the extent practicable, in compliance with requirements of the NPDES Phase II permit process.

SIERRA SUNRISE PRE-DEVELOPMENT SHED MAP

EL DORADO COUNTY, CALIFORNIA

SCALE: 1"=100'

MAY, 2017

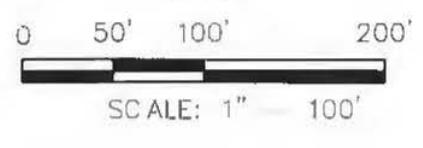
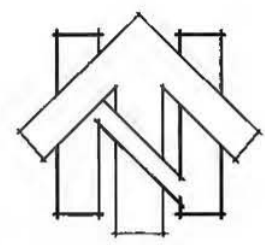

LEGEND:

- PROJECT BOUNDARY
- SHED BOUNDARY



SHED I.D. & AREA in ACRES



cta Engineering & Surveying
 Civil Engineering • Land Surveying • Land Planning
 3233 Mosler Circle, Rancho Cordova, CA 95642
 Telephone: 916.452.2071 Fax: 916.452.2072 www.cta.net

SIERRA SUNRISE POST-DEVELOPMENT SHED MAP

EL DORADO COUNTY, CALIFORNIA

SCALE: 1"=100'

MAY 2017
Updated MAY 2018

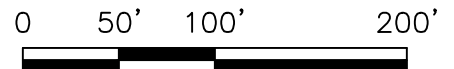
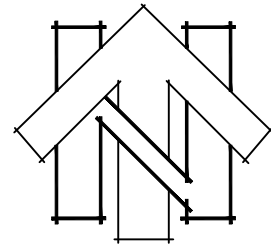

SCALE: 1" = 100'

LEGEND:

- PROJECT BOUNDARY
- SHED BOUNDARY



SHED I.D. & AREA in ACRES



SIERRA SUNRISE REGIONAL SHED MAP

EL DORADO COUNTY, CALIFORNIA

SCALE: 1"=300'

MAY, 2017

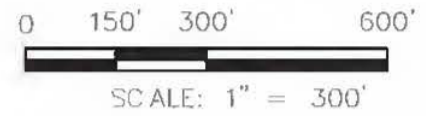
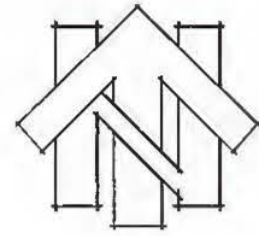

LEGEND:

- PROJECT BOUNDARY
- APPROXIMATE SHED BOUNDARY
- APPROXIMATE SHED BOUNDARY (1949 USGS QUAD MAP)
- APPROXIMATE FLOW LINE
- APPROXIMATE CULVERT LOCATION
- KEY POINT
- SHED I.D. & AREA in ACRES

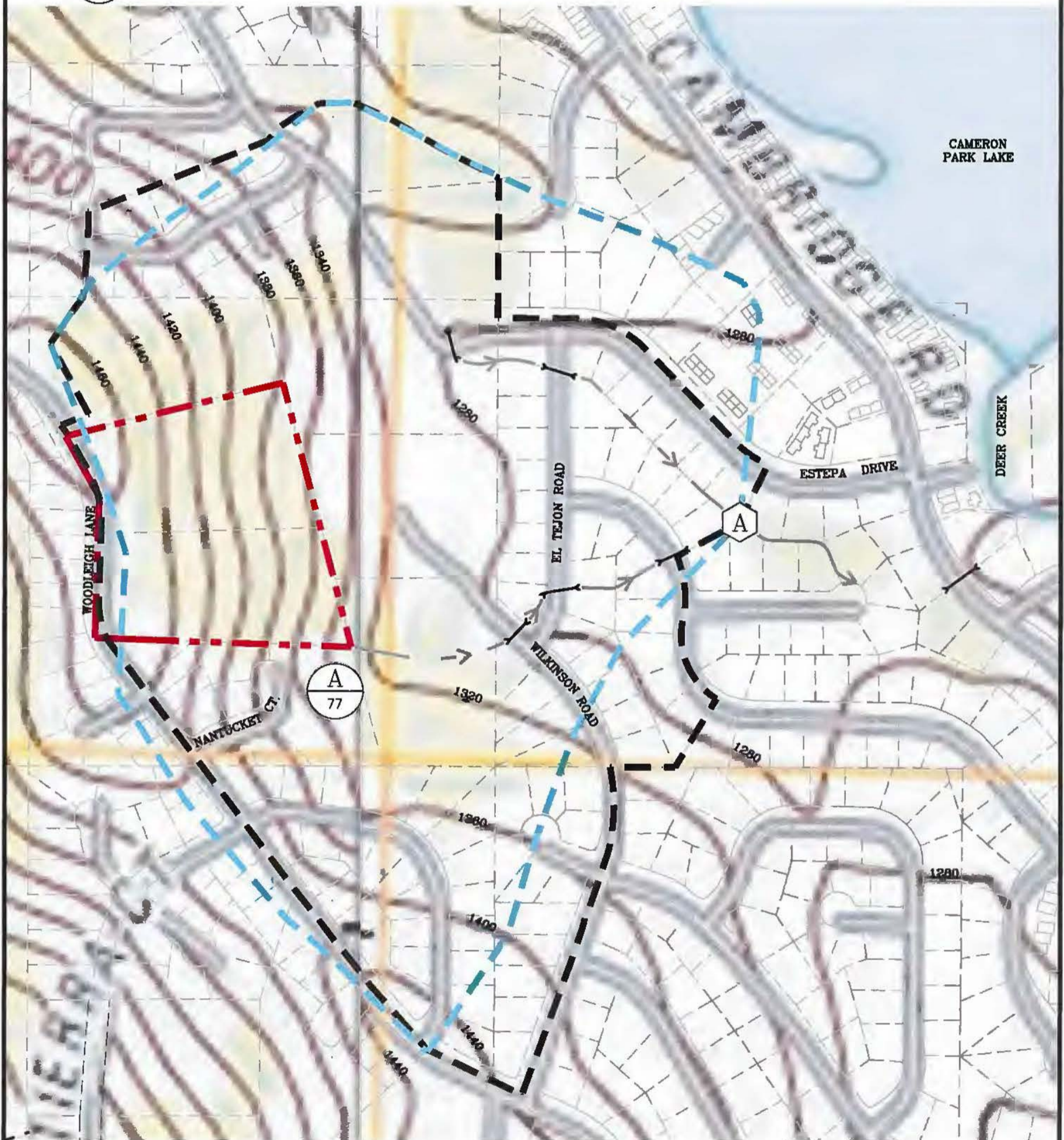

cta Engineering & Surveying
 Civil Engineering • Land Surveying • Land Planning
 3233 Mendocino Circle, Rancho Cordova, CA 95742
 T 916 498-0800 F 916 498-2078 www.cta.com

APPENDIX A
PRECIPITATION DATA

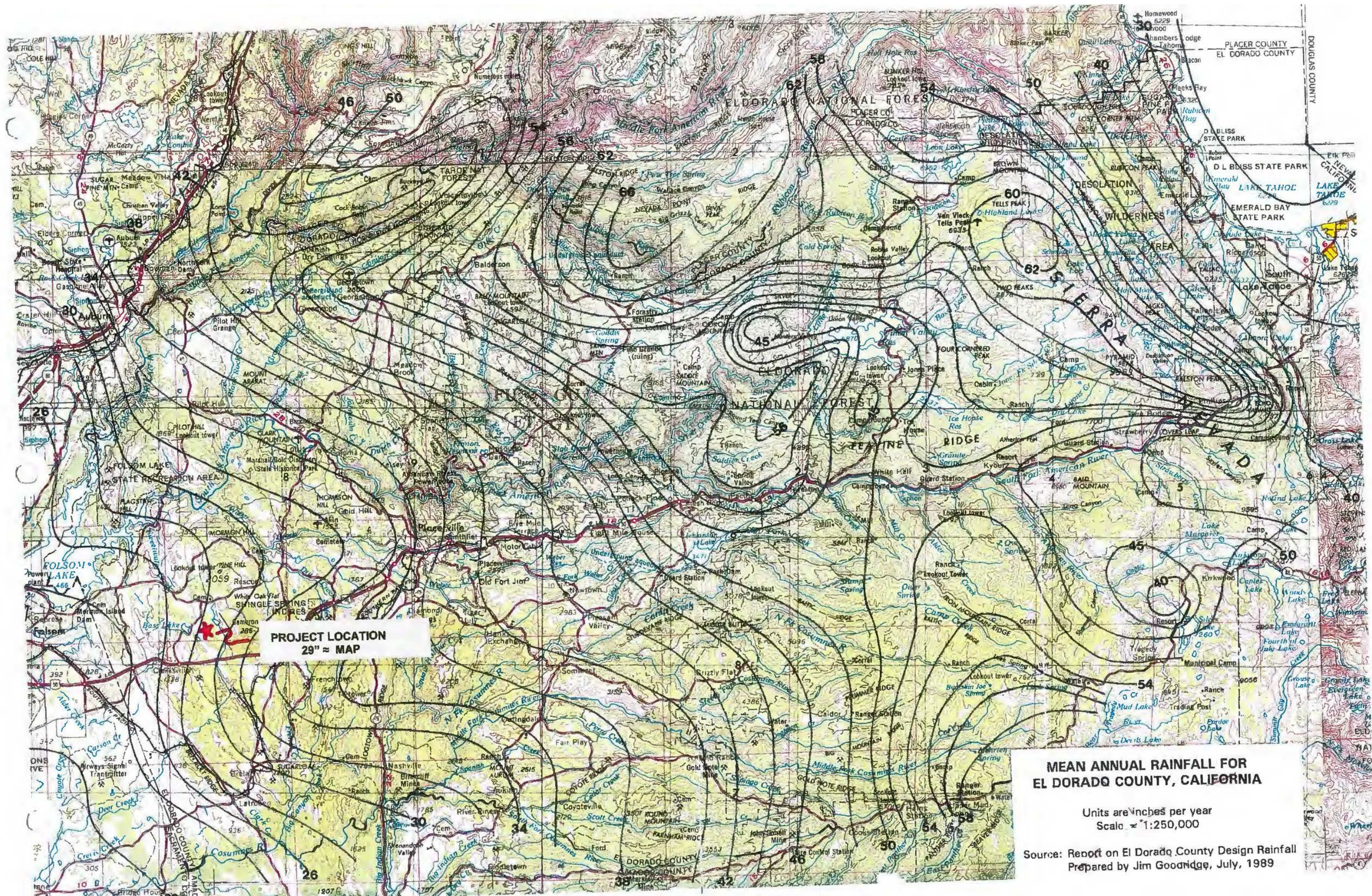

PROJECT LOCATION
29" MAP

MEAN ANNUAL RAINFALL FOR EL DORADO COUNTY, CALIFORNIA

Units are inches per year
Scale = 1:250,000

Source: Report on El Dorado County Design Rainfall Prepared by Jim Goodridge, July, 1989

El Dorado Design Rainfall

Rainfall Depth in Inches for Return Period = 10 years

Mean Annual Precipitation	5 Min	10 Min	15 Min	30 Min	1 Hr	2 Hrs	3 Hrs	6 Hrs	12 Hrs	24 Hrs
20	0.167	0.239	0.295	0.422	0.603	0.863	1.065	1.524	2.180	3.120
22	0.177	0.254	0.313	0.448	0.640	0.916	1.130	1.617	2.314	3.311
24	0.188	0.269	0.332	0.475	0.679	0.972	1.198	1.715	2.454	3.511
26	0.199	0.284	0.350	0.502	0.718	1.027	1.267	1.812	2.594	3.711
28	0.209	0.300	0.369	0.529	0.756	1.082	1.335	1.910	2.733	3.911
30	0.220	0.315	0.388	0.556	0.795	1.138	1.403	2.008	2.873	4.111
32	0.231	0.330	0.407	0.583	0.834	1.193	1.471	2.105	3.013	4.311
34	0.241	0.345	0.426	0.610	0.872	1.248	1.540	2.203	3.153	4.511
36	0.252	0.361	0.445	0.637	0.911	1.304	1.608	2.301	3.292	4.711
38	0.263	0.376	0.464	0.664	0.950	1.359	1.676	2.398	3.432	4.911
40	0.274	0.391	0.483	0.691	0.988	1.414	1.744	2.496	3.572	5.111
42	0.284	0.407	0.502	0.718	1.027	1.470	1.813	2.594	3.712	5.311
44	0.295	0.422	0.520	0.745	1.066	1.525	1.881	2.691	3.851	5.511
46	0.306	0.437	0.539	0.772	1.104	1.580	1.949	2.789	3.991	5.711
48	0.316	0.453	0.558	0.799	1.143	1.636	2.017	2.887	4.131	5.911
50	0.327	0.468	0.577	0.826	1.182	1.691	2.086	2.984	4.271	6.111
52	0.338	0.483	0.596	0.853	1.221	1.747	2.154	3.082	4.410	6.311
54	0.348	0.499	0.615	0.880	1.259	1.802	2.222	3.180	4.550	6.511
56	0.359	0.514	0.634	0.907	1.298	1.857	2.290	3.277	4.690	6.711
58	0.370	0.529	0.653	0.934	1.337	1.913	2.359	3.375	4.830	6.911
60	0.381	0.545	0.672	0.961	1.375	1.968	2.427	3.473	4.969	7.111
62	0.391	0.560	0.690	0.988	1.414	2.023	2.495	3.570	5.109	7.311
64	0.402	0.575	0.709	1.015	1.453	2.079	2.563	3.668	5.249	7.511
66	0.413	0.591	0.728	1.042	1.491	2.134	2.632	3.766	5.389	7.711
68	0.423	0.606	0.747	1.069	1.530	2.189	2.700	3.863	5.528	7.911
70	0.434	0.621	0.766	1.096	1.569	2.245	2.768	3.961	5.668	8.111
72	0.445	0.636	0.785	1.123	1.607	2.300	2.836	4.059	5.808	8.311
74	0.455	0.652	0.804	1.150	1.646	2.355	2.905	4.156	5.948	8.511
76	0.466	0.667	0.823	1.177	1.685	2.411	2.973	4.254	6.087	8.711
78	0.477	0.682	0.842	1.204	1.723	2.466	3.041	4.352	6.227	8.911
80	0.488	0.698	0.860	1.231	1.762	2.521	3.109	4.449	6.367	9.111
82	0.498	0.713	0.879	1.258	1.801	2.577	3.178	4.547	6.507	9.311
84	0.509	0.728	0.898	1.285	1.839	2.632	3.246	4.645	6.646	9.511
86	0.520	0.744	0.917	1.312	1.878	2.687	3.314	4.742	6.786	9.711
88	0.530	0.759	0.936	1.339	1.917	2.743	3.382	4.840	6.926	9.911
90	0.541	0.774	0.955	1.366	1.955	2.798	3.451	4.938	7.066	10.111

Source: Design Rainfall Tables for El Dorado County, prepared by Jim Goodridge, July 29, 1989

El Dorado Design Rainfall

Rainfall Depth in Inches for Return Period = 100 years

Mean Annual Precipitation	5 Min	10 Min	15 Min	30 Min	1 Hr	2 Hrs	3 Hrs	6 Hrs	12 Hrs	24 Hrs
20	0.237	0.339	0.418	0.598	0.855	1.224	1.509	2.160	3.091	4.423
22	0.251	0.359	0.443	0.634	0.908	1.299	1.602	2.292	3.280	4.694
24	0.266	0.381	0.470	0.673	0.963	1.377	1.699	2.431	3.478	4.977
26	0.282	0.403	0.497	0.711	1.017	1.456	1.795	2.569	3.676	5.261
28	0.297	0.425	0.524	0.749	1.072	1.534	1.892	2.708	3.874	5.544
30	0.312	0.446	0.550	0.788	1.127	1.613	1.989	2.846	4.073	5.828
32	0.327	0.468	0.577	0.826	1.182	1.691	2.086	2.984	4.271	6.111
34	0.342	0.490	0.604	0.864	1.237	1.770	2.182	3.123	4.469	6.395
36	0.357	0.511	0.631	0.903	1.291	1.848	2.279	3.261	4.667	6.678
38	0.373	0.533	0.657	0.941	1.346	1.927	2.376	3.400	4.865	6.962
40	0.388	0.555	0.684	0.979	1.401	2.005	2.473	3.538	5.063	7.245
42	0.403	0.577	0.711	1.017	1.456	2.083	2.569	3.677	5.261	7.529
44	0.418	0.598	0.738	1.056	1.511	2.162	2.666	3.815	5.459	7.812
46	0.433	0.620	0.765	1.094	1.566	2.240	2.763	3.954	5.657	8.096
48	0.448	0.642	0.791	1.132	1.620	2.319	2.860	4.092	5.856	8.379
50	0.464	0.663	0.818	1.171	1.675	2.397	2.956	4.230	6.054	8.663
52	0.479	0.685	0.845	1.209	1.730	2.476	3.053	4.369	6.252	8.946
54	0.494	0.707	0.872	1.247	1.785	2.554	3.150	4.507	6.450	9.230
56	0.509	0.729	0.898	1.286	1.840	2.633	3.247	4.646	6.648	9.513
58	0.524	0.750	0.925	1.324	1.895	2.711	3.343	4.784	6.846	9.797
60	0.539	0.772	0.952	1.362	1.949	2.790	3.440	4.923	7.044	10.080
62	0.555	0.794	0.979	1.401	2.004	2.868	3.537	5.061	7.242	10.364
64	0.570	0.815	1.006	1.439	2.059	2.946	3.634	5.200	7.440	10.647
66	0.585	0.837	1.032	1.477	2.114	3.025	3.730	5.338	7.639	10.931
68	0.600	0.859	1.059	1.516	2.169	3.103	3.827	5.476	7.837	11.214
70	0.615	0.881	1.086	1.544	2.223	3.182	3.924	5.615	8.035	11.498
72	0.630	0.902	1.113	1.592	2.278	3.260	4.021	5.753	8.233	11.781
74	0.646	0.924	1.139	1.630	2.333	3.339	4.117	5.892	8.431	12.064
76	0.661	0.946	1.166	1.669	2.388	3.417	4.214	6.030	8.629	12.348
78	0.676	0.967	1.193	1.707	2.443	3.496	4.311	6.169	8.827	12.631
80	0.691	0.989	1.220	1.745	2.498	3.574	4.408	6.307	9.025	12.915
82	0.706	1.011	1.246	1.784	2.552	3.652	4.504	6.446	9.223	13.198
84	0.722	1.032	1.273	1.822	2.607	3.731	4.601	6.584	9.421	13.482
86	0.737	1.054	1.300	1.860	2.662	3.809	4.698	6.722	9.620	13.765
88	0.752	1.076	1.327	1.899	2.717	3.888	4.795	6.861	9.818	14.049
90	0.767	1.098	1.354	1.937	2.772	3.966	4.891	6.999	10.016	14.332

Source: Design Rainfall Tables for El Dorado County, prepared by Jim Goodridge, July 29, 1989

APPENDIX B
EXCERPTS FROM SOIL RESOURCES REPORT

Custom Soil Resource Report
Soil Map



Map Unit Legend

El Dorado Area, California (CA624)			
Map Unit Symbol	Map Unit Name	Acres in AOI	Percent of AOI
LaB	Loamy alluvial land	54.5	19.0%
PrD	Placer diggings	1.6	0.6%
ReB	Rescue sandy loam, 2 to 9 percent slopes	16.0	5.6%
ReC	Rescue sandy loam, 9 to 15 percent slopes	0.6	0.2%
RfC	Rescue very stony sandy loam, 3 to 15 percent slopes	18.3	6.4%
RgE2	Rescue extremely stony sandy loam, 3 to 50 percent slopes, eroded	188.6	65.8%
Rk	Rescue clay, clayey variant	5.9	2.1%
W	Water	1.1	0.4%
Totals for Area of Interest		286.5	100.0%

Map Unit Descriptions

The map units delineated on the detailed soil maps in a soil survey represent the soils or miscellaneous areas in the survey area. The map unit descriptions, along with the maps, can be used to determine the composition and properties of a unit.

A map unit delineation on a soil map represents an area dominated by one or more major kinds of soil or miscellaneous areas. A map unit is identified and named according to the taxonomic classification of the dominant soils. Within a taxonomic class there are precisely defined limits for the properties of the soils. On the landscape, however, the soils are natural phenomena, and they have the characteristic variability of all natural phenomena. Thus, the range of some observed properties may extend beyond the limits defined for a taxonomic class. Areas of soils of a single taxonomic class rarely, if ever, can be mapped without including areas of other taxonomic classes. Consequently, every map unit is made up of the soils or miscellaneous areas for which it is named and some minor components that belong to taxonomic classes other than those of the major soils.

Most minor soils have properties similar to those of the dominant soil or soils in the map unit, and thus they do not affect use and management. These are called noncontrasting, or similar, components. They may or may not be mentioned in a particular map unit description. Other minor components, however, have properties and behavioral characteristics divergent enough to affect use or to require different management. These are called contrasting, or dissimilar, components. They generally are in small areas and could not be mapped separately because of the scale used. Some small areas of strongly contrasting soils or miscellaneous areas are identified by a special symbol on the maps. If included in the database for a given area, the contrasting minor components are identified in the map unit

Custom Soil Resource Report

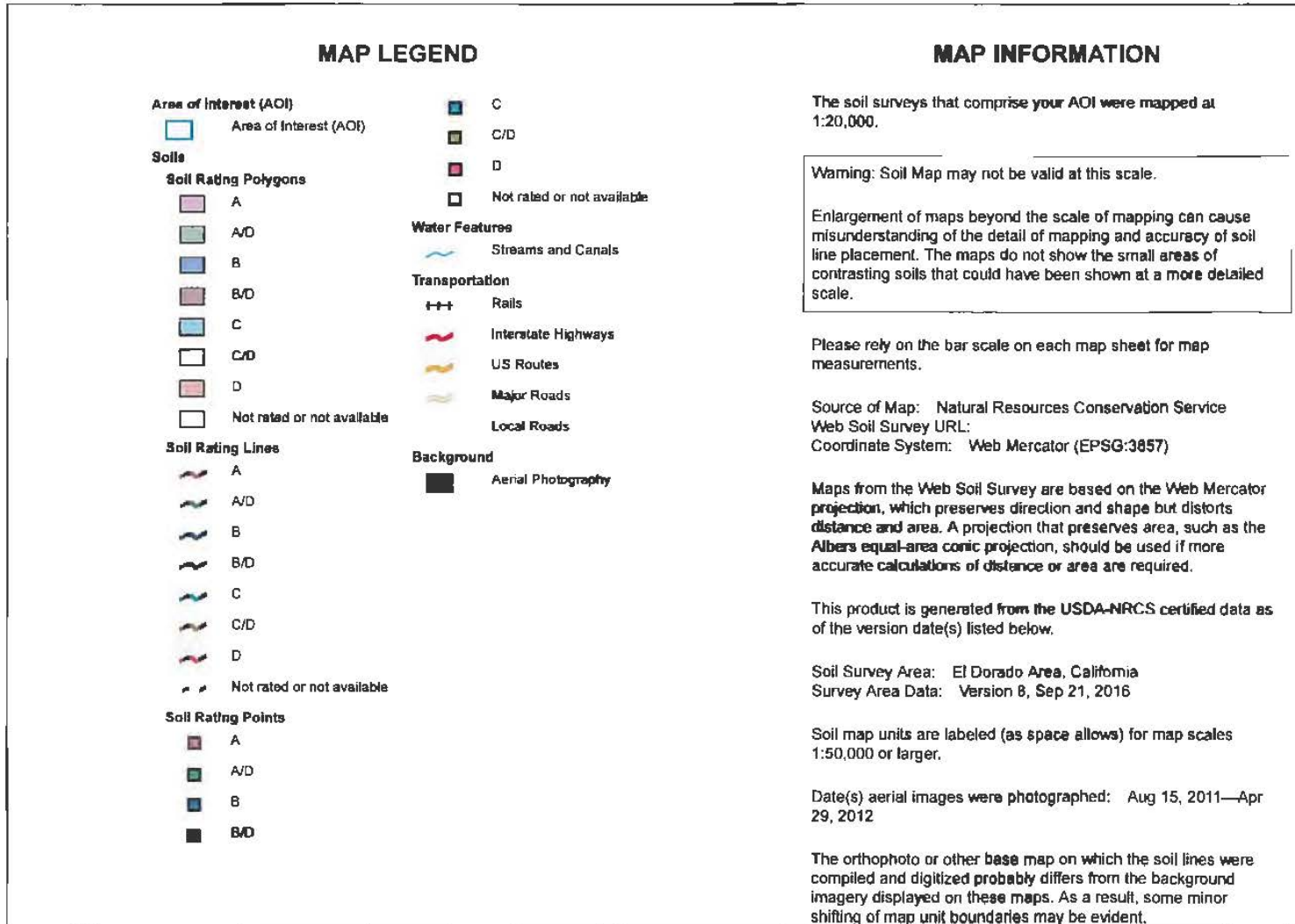

APPENDIX C
DRAINAGE SHED PARAMETERS

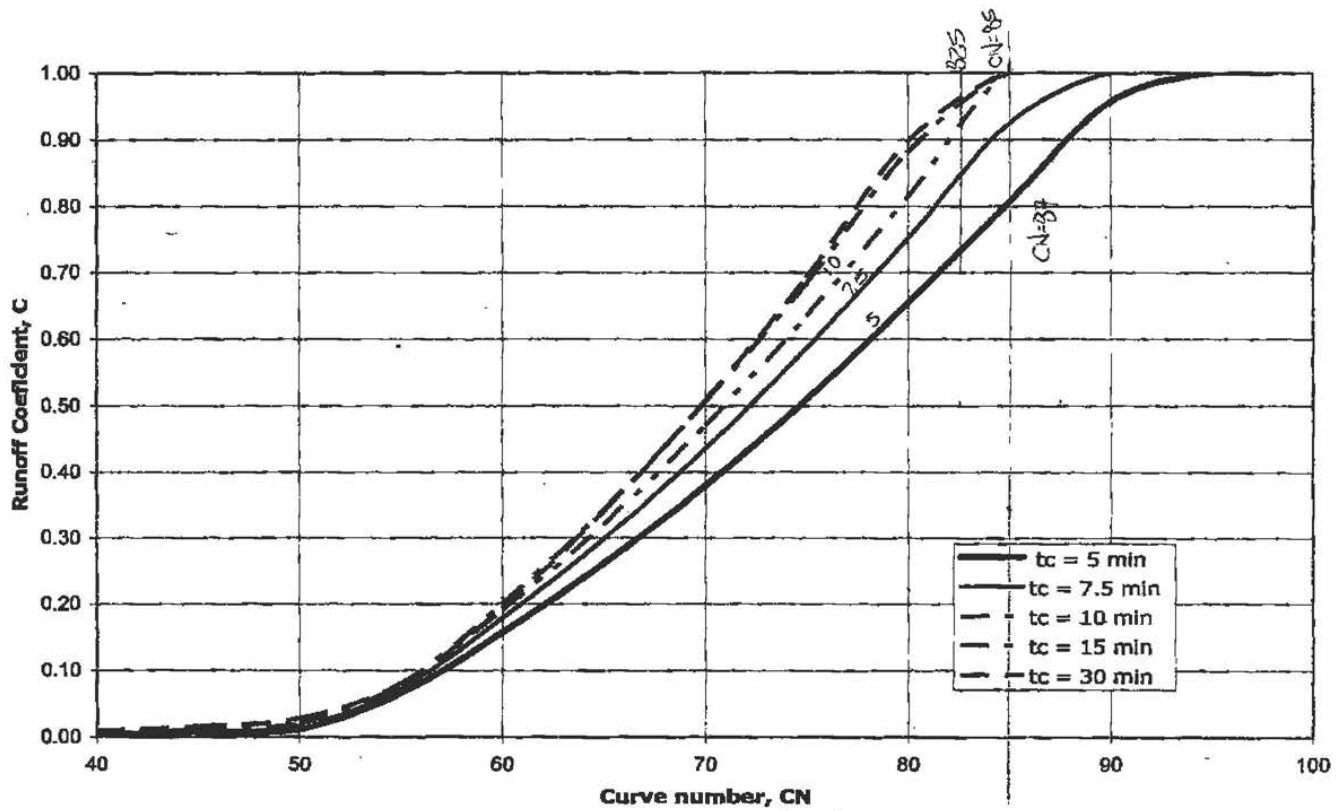

Figure 4. Runoff coefficients for 10-yr event below 1,640 ft (NRCS type 1 storm)

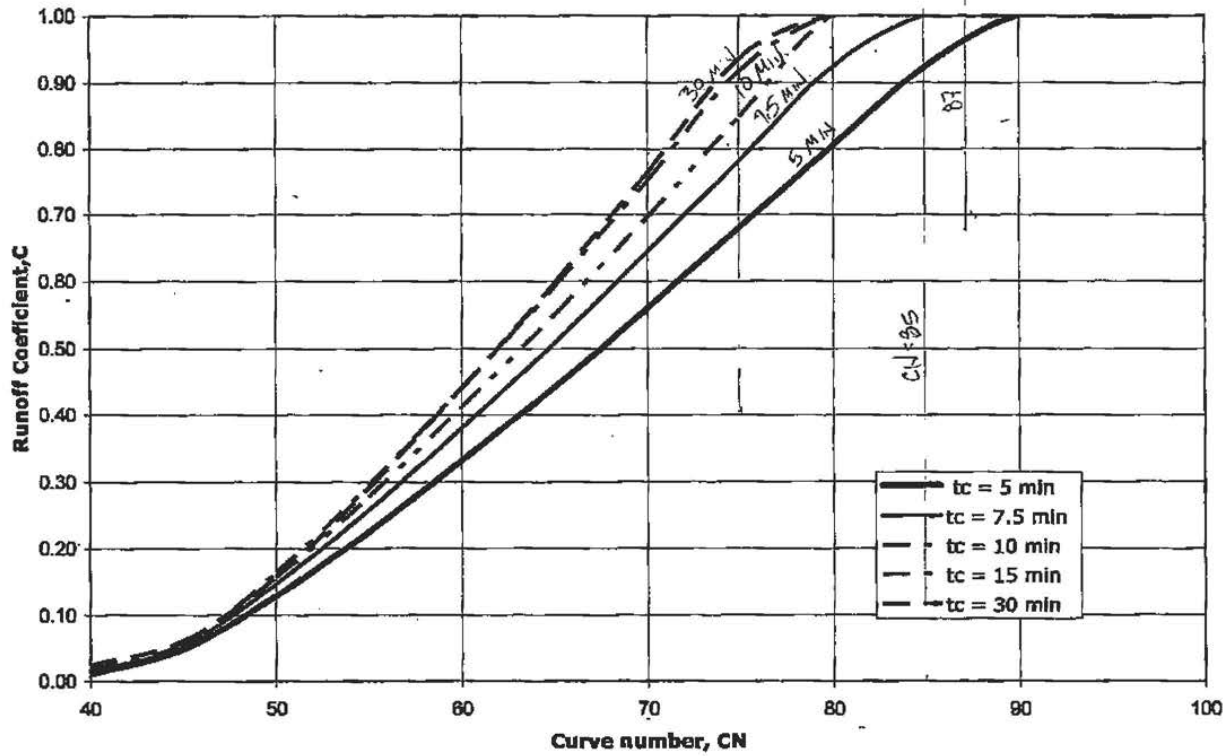

Figure 6. Runoff coefficients for 100-yr event below 1,640 ft (NRCS type 1 storm)

APPENDIX D
PEAK RUNOFF COMPUTATIONS

**TABLE D-1
PEAK FLOW COMPUTATIONS**

SIERRA SUNRISE												
SHED	PRE-PROJECT						POST-PROJECT					
	A (ac)	CN	Tc (min)	C	i (in/hr)	Q (cfs)	A (ac)	CN	Tc (min)	C	i (in/hr)	Q (cfs)
10-YEAR												
A	0.9	79	10	0.87	1.85	1.4	1.7	77	10	0.7	1.85	2.2
B	0.9	72	25	0.55	1.22	0.6	0.6	81	10	0.88	1.85	1.0
A+B	na						2.3	78	10	0.81	1.85	3.4
C	8.1	65	23	0.34	1.28	3.5	7.5	68	20	0.45	1.37	4.6
100-YEAR												
A	0.9	79	10	1	2.61	2.3	1.7	77	10	0.92	2.61	4.1
B	0.9	72	25	0.84	1.74	1.3	0.6	81	10	1	2.61	1.6
A+B	na						2.3	78	10	0.98	2.61	5.9
C	8.1	65	23	0.58	1.82	8.6	7.5	68	20	0.68	1.95	9.9

APPENDIX E
RUNOFF HYDROGRAPH COMPUTATIONS

Project: SIERRA SUNRISE Simulation Run: 10 YEAR

Start of Run: 31Dec2017, 00:00

Basin Model: SIERRA SUNRISE

End of Run: 01Jan2018, 01:00

Meteorologic Model: 10 YEAR

Compute Time: 15May2017, 10:54:45

Control Specifications:Control 1

Hydrologic Element	Drainage Area (MI ²)	Peak Discharge (CFS)	Time of Peak	Volume (IN)
PRE	0.12	56.86	31Dec2017, 10:10	1.77
POST	0.12	57.81	31Dec2017, 10:10	1.79

Project: SIERRA SUNRISE Simulation Run: 100 YEAR

Start of Run: 31Dec2017, 00:00

Basin Model: SIERRA SUNRISE

End of Run: 01Jan2018, 01:00

Meteorologic Model: 100 YEAR

Compute Time: 15May2017, 10:54:45

Control Specifications:Control 1

Hydrologic Element	Drainage Area (MI ²)	Peak Discharge (CFS)	Time of Peak	Volume (IN)
PRE	0.12	108.54	31Dec2017, 10:10	3.16
POST	0.12	109.74	31Dec2017, 10:10	3.19

Custom Soil Resource Report

Table—Hydrologic Soil Group

Hydrologic Soil Group— Summary by Map Unit — El Dorado Area, California (CA624)				
Map unit symbol	Map unit name	Rating	Acres in AOI	Percent of AOI
LaB	Loamy alluvial land		54.5	19.0%
PrD	Placer diggings		1.6	0.6%
ReB	Rescue sandy loam, 2 to 9 percent slopes	C	16.0	5.6%
ReC	Rescue sandy loam, 9 to 15 percent slopes	C	0.6	0.2%
RfC	Rescue very stony sandy loam, 3 to 15 percent slopes	C	18.3	6.4%
RgE2	Rescue extremely stony sandy loam, 3 to 50 percent slopes, eroded	C	188.6	65.8%
Rk	Rescue clay, clayey variant	C/D	5.9	2.1%
W	Water		1.1	0.4%
Totals for Area of Interest			286.5	100.0%

Rating Options—Hydrologic Soil Group

Aggregation Method: Dominant Condition

Component Percent Cutoff: None Specified

Tie-break Rule: Higher

SIERRA SUNRISE POST-DEVELOPMENT SHED MAP

EL DORADO COUNTY, CALIFORNIA
SCALE: 1"=100' MAY, 2018

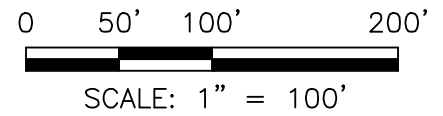
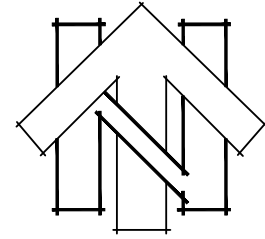

LEGEND:

- PROJECT BOUNDARY**
- SHED BOUNDARY**
- SHED I.D. & AREA in ACRES**



SIERRA SUNRISE (P) DRIVEWAY EXHIBIT & OPTIONAL ON-STREET PARKING EL DORADO COUNTY, CALIFORNIA

AUGUST, 2017
SCALE: AS NOTED

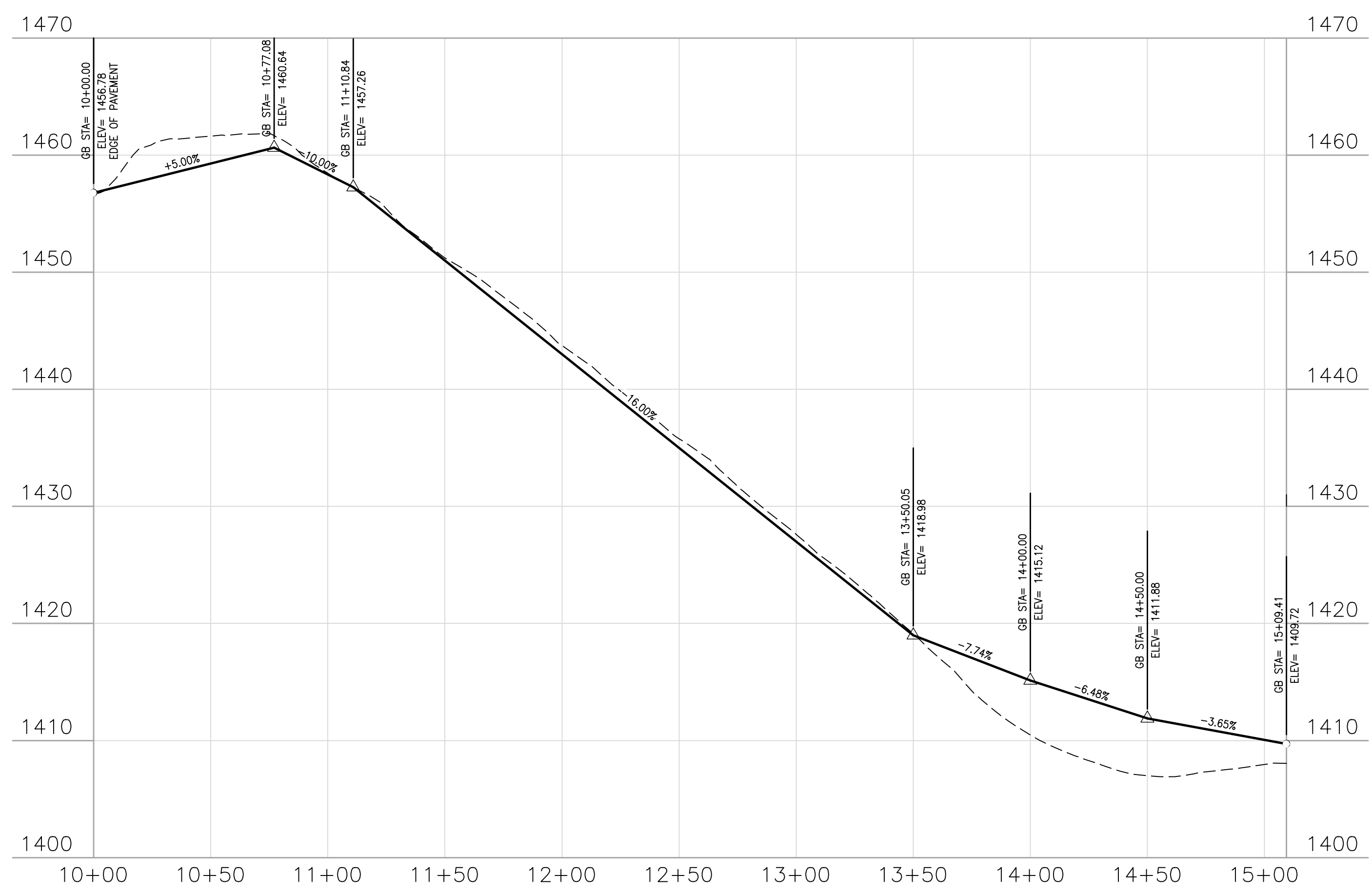
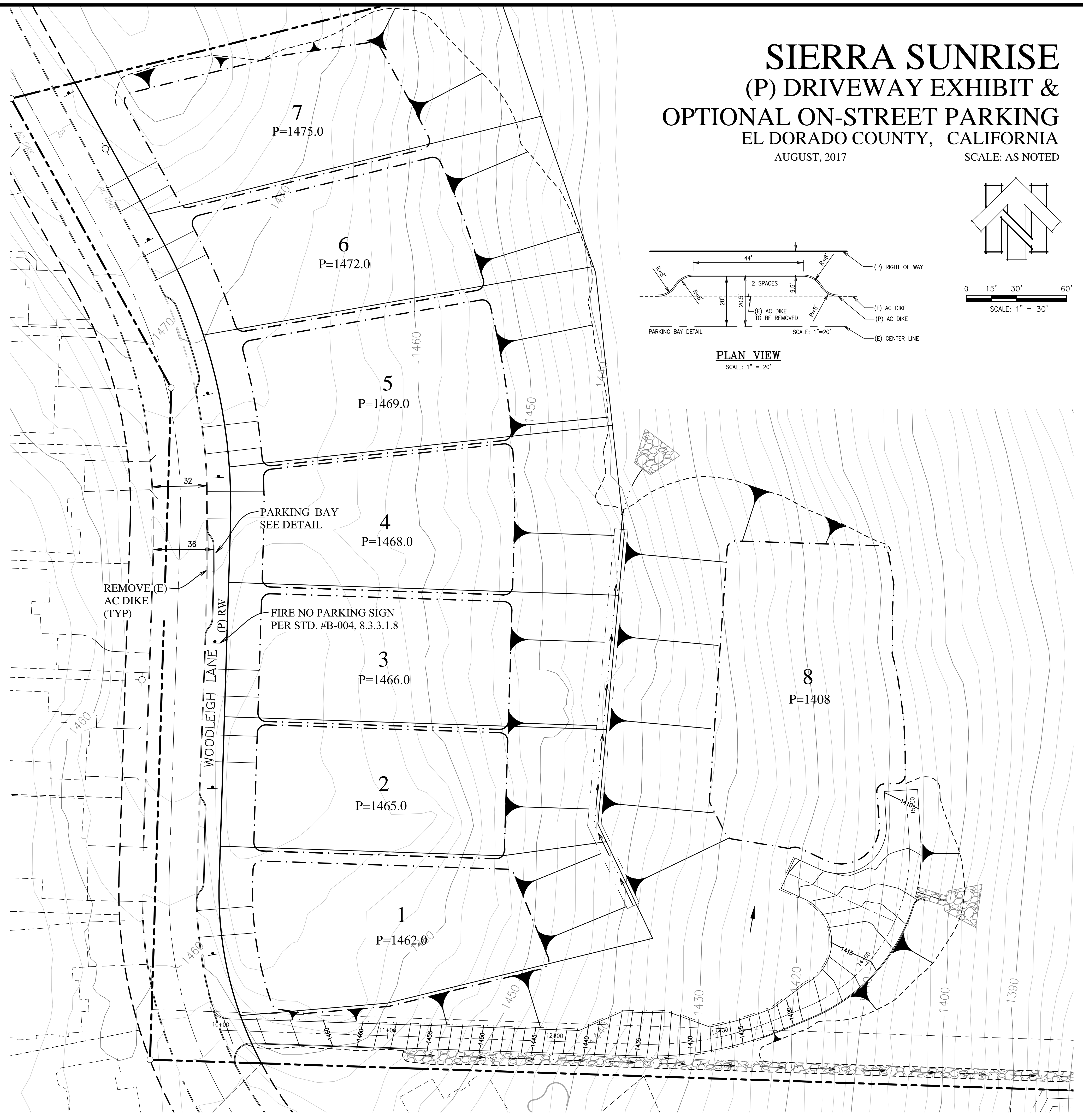
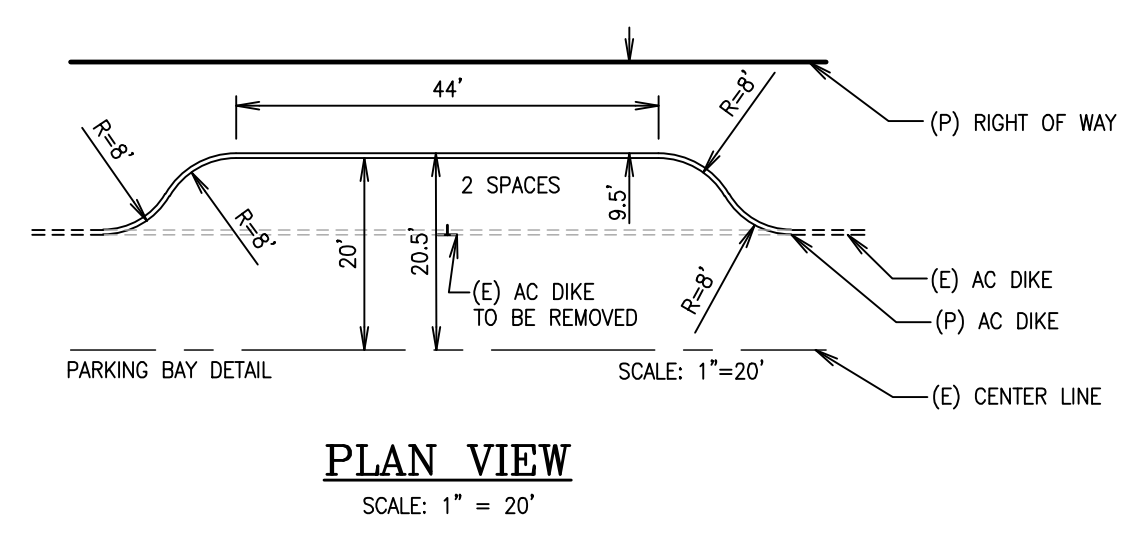
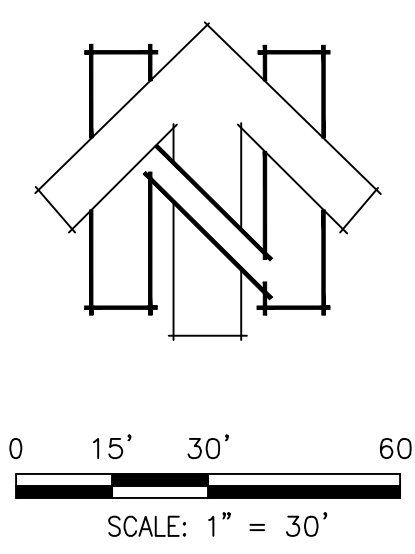

(P) DRIVEWAY PROFILE