



LATE DISTRIBUTION

DATE

10/8/2018 BOS 10/6/2018

#40 & 41

EDC COB <edc.cob@edcgov.us>

DR-R18-0001 Saratoga Retail Appeal Hearing(s) Legistar 18-1497 and 18-1498

1 message

El Dorado Hills Area Planning Advisory Committee <info@edhapac.org> Fri, Oct 5, 2018 at 6:15 PM
To: "edc.cob@edcgov.us" <edc.cob@edcgov.us>, "bosone@edcgov.us" <bosone@edcgov.us>, "bostwo@edcgov.us" <bostwo@edcgov.us>, "bostthree@edcgov.us" <bostthree@edcgov.us>, "bosfour@edcgov.us" <bosfour@edcgov.us>, "bosfive@edcgov.us" <bosfive@edcgov.us>
Cc: "tjwhitejd@gmail.com" <tjwhitejd@gmail.com>, "jjrazz@sbcglobal.net" <jjrazz@sbcglobal.net>, "hpkp@aol.com" <hpkp@aol.com>, "charlet331@gmail.com" <charlet331@gmail.com>, Ellison Rumsey <aerumsey1@gmail.com>







Hello,

The El Dorado Hills Area Planning Advisory Committee would like to include this public comment letter and accompanying attachments for consideration of the Board Of Supervisors in regards to their Tuesday October 9, 2018 BOS Meeting Agenda Items 40 & 41 (18-1497 & 18-1498) - hearings appealing the Planning Commission's August 23, 2018 approval of Design Review Revision DR-R18-0001/Saratoga Retail Phase 2.

Kind regards,
John Davey
2018 EDHAPAC Vice Chair

El Dorado Hills Area Planning Advisory Committee
1021 Harvard Way
El Dorado Hills CA 95762
<https://edhapac.org>
info@edhapac.org

12 attachments

-  **1 EDHAPAC_DR-R18-0001_Saratoga_Retail_Phase2_BOS_OCT-9-2018_appeal.pdf**
240K
-  **2 EDC_PlanningCommission_Public Comment Rcvd 08-20-18.pdf**
469K
-  **3 Parking-and-Loading-Standards-adopted-12-15-2015_PG_1_8.pdf**
115K
-  **4 California_Streets_Highways_Code_5870.pdf**
120K
-  **Citation1.pdf**
1123K
-  **Citation2.pdf**
128K
-  **Citation3.pdf**
102K
-  **Citation4.pdf**
1210K



El Dorado Hills Area Planning Advisory Committee

1021 Harvard Way
El Dorado Hills, CA 95762

2018 Board Chair

Tim White

Vice Chair

John Raslear

Secretary

Kathy Prevost

Vice Chair

John Davey

October 8, 2018

The County of El Dorado Board of Supervisors
County of El Dorado Planning and Building Department
El Dorado County Planning Services
2850 Fairlane Court
Placerville, CA 95667

**RE: APPEAL HEARING of DR-R18-0001 Saratoga Retail Phase 2
Legistar Calendar Files 18-1497 & 18-1498**

Dear County of El Dorado Board of Supervisors,

The El Dorado Hills Area Planning Advisory Committee (“EDHAPAC”) would like to offer these comments to be included in the public record, prior to your consideration of the two appeal requests of the Planning Commission’s August 23, 2018 approval of Design Review Revision DR-R18-0001/Saratoga Retail Phase 2.

On August 17, 2018 EDHAPAC submitted to the Planning Commission the result of our unanimous vote of Non-Support for the Project as proposed

[<https://eldorado.legistar.com/View.ashx?M=F&ID=6464991&GUID=37F64D7D-8468-4FA9-9CF1-B6D16E2F110E> – also, attached].

After reviewing the documents on file for the Project from the Planning Department and the Planning Commission, EDHAPAC believed significant issues regarding traffic, RV parking, internal circulation, and design review standards existed, that were not mitigated by the project as proposed by the applicant, and found legitimate concerns regarding the MITIGATED NEGATIVE DECLARATION prepared by County Planning Staff. EDHAPAC was concerned and confused that Planning Department Staff would prepare a Mitigated Negative Declaration for this Project that does not address (in fact, completely ignores) the County of El Dorado Ordinance governing drive thru facilities. The Community Design Standards for Parking and Lodging, Section H, 1-8 mandates that drive thru facilities SHALL (not “should” or “can” but “shall”) comply with the circulation and traffic control standards set forth therein. Subsection 2 (H.2) provides that ingress to and egress from a drive thru facility shall be prohibited from driveways directly facing a residential zone. All 4 proposed access driveways for this Project face a Residential Zoned Neighborhood.

The reason the County of El Dorado mandated the 8 specific compliance standards goes to the heart of the issue with a drive thru restaurant at this location – it is located immediately adjacent to a long-established residential neighborhood, (in fact the original and very first El Dorado Hills village, Park Village) and the County’s intent was and is to protect residential neighborhoods from the intrusiveness of such an establishment.

At the August 23, 2018 El Dorado County Planning Commission Hearing, it was presented to the public by County Staff and the Planning Commissioners that in reference to The Community Design Standards for Parking and Lodging, Section H Subsection 2 (H.2) that the phrase “**driveways**” was meant to indicate only the vehicle access areas of the drive thru facilities, and not the driveways used to access the project property from the public road – Saratoga Way. This stands in direct conflict with California Streets and Highways Code § 5870 definition of “**driveway**”:

*According to California Streets and Highways Code, "**Driveway**" means a **paved portion of a public street providing an unobstructed passage from the roadway to an offstreet area** used for driving, servicing, parking, or otherwise accommodating motor vehicles. [Cal Sts & Hy Code § 5870] [https://leginfo.ca.gov/faces/codes_displaySection.xhtml?lawCode=SHC§ionNum=5870.]*

In reviewing municipal codes, ordinances, design standards, and design guidelines regulating drive thru facilities in several other California municipalities and California County jurisdictions, we find that they consistently, and tellingly, use the phrase **driveway** as defined in the California Streets and Highways Code § 5870, and use the phrases “**Drive Aisle**”, “**Drive Thru Aisle**”, “**Drive Lane**”, “**Drive Thru Lane**”, “**Aisle**”, and “**Lane**” to define the vehicle access areas of the drive thru facilities themselves. We cite several examples herein:

Citation 1:

City of Roseville CA

<http://roseville.ca.us/common/pages/DisplayFile.aspx?itemId=8836813>

Design Guidelines for Commercial Development

I. Site Design Guidelines

A. Site Planning and Building Siting

Design Guidelines

CC-4 Consideration should be given to the orientation of service bays, **drive-thru lanes**, pickup windows, and other utilitarian building functions toward the street.

- If **drive-thru lanes** must be adjacent to the street, they shall be screened through the use of low walls and/or landscaping.
- If pickup windows must be oriented toward the street, they shall be de-emphasized through screening and/or architectural treatment.

CC-27 Paving material for **driveways**, **drive aisles**, and walkways should be consistent with the architectural style of the buildings and should incorporate similar accent elements.

Technical Guidelines

CC-30 **Drive through aisles for fast food restaurants** shall provide a minimum of 180 feet of stacking distance (measured from the pickup window) that does not conflict with the on-site parking and circulation system.

Other similar operations such as car washes and automatic teller machines shall provide a minimum of 100 feet of stacking.

F. Service and Storage

CC-35 **Drive-thru lanes** adjacent to roadways should be screened from view through a combination of low screen walls (“**nee walls**”), berming, and landscaping.

CC-66 Trees and shrubs planted at all intersections and **driveways** shall be selected and located to maintain safe sight line distances per the City’s Clear Vision Triangle as defined in the Zoning Ordinance.

III. Public Space Guidelines

A. Streetscape Design

Design Guidelines

CC-51* Projects shall address bicycle and pedestrian needs in their design. Options to achieve this include, but are not limited to:

- Providing physical separation from streets and **drive aisles** through landscaping to encourage walking.
- Providing pedestrian pathways through parking lots separated from **drive aisles**.

Design Guidelines for Office and Industrial Development

E. Access, Circulation, and Parking

OI-20 Vehicular access to the site, internal circulation, and parking lot designs should consider the following:

- **Drive through aisles** for automatic teller machines shall provide a minimum of 100 feet of stacking distance that does not conflict with the on-site parking and circulation system.

- The determination of adequate stacking for project **entry driveways** shall account for security gates, checkpoints and guard shacks if applicable.

OI-22 Paving material for **driveways, drive aisles**, and walkways should be consistent with the architectural style of the buildings and should incorporate similar accent elements.

F. Service and Storage

OI-29 **Drive-thru lanes** adjacent to roadways should be screened from view through a combination of low screen walls (“knee walls”), berming, and landscaping.

Appendix B

Parking Lot Shading Requirements

Parking areas not subject to the shading requirement include:

1. Truck loading areas in front of overhead doors;
2. Truck maneuvering and parking areas separate from other vehicle parking areas;
3. **Driveways**;
4. Surfaced areas not accessible for vehicle parking, driving or maneuvering;

Citation 2:

City of Elk Grove

Chapter 23.78

DRIVE-IN AND DRIVE-THROUGH FACILITY

<https://www.codepublishing.com/CA/ElkGrove/html/ElkGrove23/ElkGrove2378.html>

23.78.030 Development standards.

The development standards in this section are intended to supplement the standards in the underlying zoning district for drive-in and drive-through uses. In the event of conflict between these standards and the underlying zoning district standards, the provisions of this section shall apply.

A. **Drive-Through Aisles.** The minimum standards for **drive-through aisles** are as follows:

1. **Drive-through aisles** shall have a minimum ten (10' 0") foot interior radius at curves and a minimum twelve (12' 0") foot width.
2. Drive-up windows and remote tellers shall provide at least one hundred eighty (180' 0") feet of stacking space for each facility, as measured from the service window or unit to the entry point into the drive-up lane. Nonfood and/or nonbeverage businesses may reduce the stacking space to a minimum of sixty (60' 0") feet.
3. Each **drive-through entrance/exit** shall be at least fifty (50' 0") feet from an intersection of public rights-of-way, measured at the closest intersecting curbs, and at least twenty-five (25' 0") feet from the curb-cut on an adjacent property. Exceptions may be granted by the designated approving authority when **drive-through** pull-out spaces are provided.
4. Each entrance to an **aisle** and the direction of traffic flow shall be clearly designated by signs and pavement markings.
5. Each **drive-through aisle** shall be separated from the circulation routes necessary for ingress or egress from the property, or access to a parking space.

Citation 3:

Sacramento City Code

17.228.109 Drive-through restaurant.

B. Development standards. The development standards in this subsection B shall be used to analyze the adequacy of the design of a drive-through restaurant.

1. A minimum stacking distance of 180 feet shall be provided to each pick-up window or automated machine.
2. A drive-through restaurant service facility with a separate ordering point and pick-up window shall provide stacking space for at least four vehicles in advance of each ordering point and stacking space for at least four vehicles between each ordering point and pick-up window.
3. Entrances to *drive-through lanes* shall be at least 25 feet **from driveways** entering a public or private street or alley.
4. A drive-through restaurant service facility shall not be considered as justification for reducing the number of required parking spaces.
5. The minimum width of each *drive-through lane* is 11 feet. The entrance to the lane and the direction of traffic flow shall be clearly designated by signs and pavement marking or raised curbs.

C. Guidelines. The guidelines in this subsection C shall be used in analyzing the adequacy of the design of the drive-through restaurant. The decision-maker may require redesign of a drive-through restaurant to comply with these guidelines.

3. Interior landscaping shall be installed on the site to offset the extensive pavement area devoted to the *drive-through lane*. (Ord. 2013-0020 § 1; Ord. 2013-0007 § 1)

Citation 4:

City of Rancho Cordova

<http://www.cityofranhocordova.org/home/showdocument?id=361>

DESIGN GUIDELINES

2. Automobile dependent land uses (e.g. car lot sales lots, gas stations, drive-up restaurants and other drive-up facilities) should be designed to reduce conflicts with pedestrians, by the following means:

- Place the building at the building setback line with an entry from the public sidewalk to help define the “street edge” and encourage pedestrian access (e.g. to a convenience store, restaurant, or a car dealer showroom);
- Create a direct pedestrian connection between public sidewalk and pad building entries without crossing a *drive through lane*;
- Place the *drive through area* away from pedestrian areas.

AVOID

- Pedestrian crossings of vehicular **driveways** without adequate protections.

COMMERCIAL AND COMMERCIAL MIXED USE

The City seeks to create rich, inviting, pedestrian oriented urban streetscapes as part of its commercial development, especially in a “Main Street” pattern. To accomplish this, the front and street side building setbacks have been modified, as described in the table below, based on project size. The distance is measured from the back of curb of the ultimate right-of-way width. A minimum of 50 percent of this setback envelope shall be occupied by either a primary building frontage (having the main entrance(s) to the building) or pedestrian feature(s). In no instance shall on-site parking or *drive-thru aisles* be located within this setback, however on-street parking, subject to review by the Public Works department, may be provided. *Drive aisles* connecting the parking areas to the public street are allowed in the setback area. The setback area may include

landscaping or other pedestrian amenities as described in this document or the City Zoning Code. The design review authority may grant exemption when the intent is met by unique development features or there are unique site characteristics or patterns that preclude such action.

4. Corner and mid-block pad buildings should be oriented towards the street and public sidewalk and shall meet the following requirements:

- Drive-thru windows, **driveways**, and parking shall not be designed in a manner that isolates the building from the sidewalk or connecting walkways.
- Service windows and stacking **lanes** for drive thru business shall not face public streets. Rather, orient automotive service bays away from public streets. The intent is that service bays should not dominate the public street frontage.

Citation 5:

City of Citrus Heights

https://library.municode.com/ca/citrus_heights/codes/code_of_ordinances?nodeId=COOR_CH106ZO_CH106.42STSPLAUS_S106.42.080DRROFA

Municipal Code Sec. 106.42.080. - Drive-Through Facilities

Where allowed by Article 2 (Zoning Districts and Allowable Land Uses), drive-through facilities shall comply with the requirements of this Section.

A. General standards.

1. Design objectives. A drive-through facility shall be designed and operated to mitigate problems of congestion, excessive pavement, litter, and noise.
2. Limitation on location. A drive-through facility shall be planned and designed to minimize its visibility from a public right-of-way.
3. Screening. The **drive-through aisle** and stacking area shall be screened from the view of the street by a combination of decorative low walls, berming, and landscaping, as determined by the review authority.

B. On-site circulation standards. A drive-through facility shall be provided internal circulation and traffic control as follows:

1. **Drive-through aisle** design.

- a. The entrance and exit of a **drive aisle** shall both be a minimum of 25 feet **from any driveway providing access to the site from a public street**.
 - b. Each **drive aisle** shall be designed with a minimum 10-foot interior radius at curves and a minimum 10-foot width.
2. Stacking area. A clearly identified area shall be provided for vehicles waiting for drive-through service that is separated from other on-site traffic circulation on the site.
 - a. Location. A stacking area shall not be located adjacent and parallel to a street or public right-of-way, unless the review authority determines that there is no feasible alternative.
 - b. Capacity. A **drive-through aisle** that provides access to a service window shall be designed to provide the following length of stacking space, measured from the service window to the entry point into the **drive-through lane**.
 - (1) Restaurants. An aisle accessing a food service window (ordering or pickup, whichever occurs first in a **drive through aisle**) shall be designed to provide at least 120 feet of stacking space.

E. Signs. Each entrance to, and exit from a **drive-through aisle** shall be clearly marked to show the direction of traffic flow by signs and pavement markings or raised curbs.

Citation 6:

City of San José, California

CRITERIA FOR THE REVIEW OF DRIVE-THROUGH USES

<https://www.sanjoseca.gov/DocumentCenter/View/3877>

CRITERIA

The following criteria shall be applied to all applications for development of establishments with drive-through facilities which meet the applicable conditional requirements:

I TRAFFIC

A. Primary ingress and egress to drive-through type use parking lots should be from at least a four-lane major street.

B. The *drive-through stacking lane* shall be situated so that any overflow from the stacking lane shall not spill out onto public streets or major aisles of any parking lot. Overflow capacity shall be 50 percent of required stacking for overflow restricted to the parking lot and 100 percent of required stacking if the overflow is directed to the street.

C. No ingress and egress points shall conflict with turning movements of street intersections.

D. No drive-through use shall be approved with ingress or egress **driveways** within 300 feet of a signalized intersection operating at a Level of Service D, E, or F unless a traffic analysis demonstrates, to the satisfaction of the Director of Public Works, that vehicles entering or leaving said use will not impair the efficiency or operation of the intersection.

E. The *drive-through stacking lane* shall be separated physically from the user's parking lot and shall have a capacity of:

1. Financial Institutions—8 cars per *lane* or 16 total*;
2. Restaurants—8 cars per *lane**;
3. Photo Uses—2 cars per *lane**;
4. Self-Service Car Washes—5 cars per *lane**;
5. Full-Service Car Washes—15 cars* (may be in multiple *lanes*);
6. Other—Capacity requirement to be determined on an individual basis.

*Allow 20 feet per car

The storage required for savings and loans may be less than for banks, and should be reviewed on an individual basis.

Eight (8) vehicles per *lane* for a drive-through restaurant is a maximum. Certain types of fast-food restaurants may require less storage if substantiated by acceptable data.

F. No pedestrian crossing of the *drive-through lane* shall be allowed.

G. Proposed drive-through uses at or near signalized intersections may compound existing traffic congestion and make it intolerable even if the intersection meets the Transportation LOS Policy. In these situations, proposed drive-through uses should be discouraged.

Citation 7:

Riverside CA Municipal Code

<https://www.riversideca.gov/municode/pdf/19/article-7/19-475.pdf>

D. *Drive-thru Lane* Standards

1. Restaurants shall maintain *drive-thru lanes* that are a minimum of 180 feet in length to provide on-site storage for a minimum of 10 vehicles, as measured from the forward most drive-thru window to the entrance to the queuing space.

2. All other uses shall maintain drive-thru lanes that are a minimum of 36 feet in length to provide on-site automobile storage for a minimum of 2 vehicles.

3. Each *drive-thru lane* shall be a minimum of 12 feet in width. The *lane* shall be independent of any on-site parking, parking maneuvering areas, public streets, alleys or traffic ways.

E. Additional requirements for *drive-thru lanes* associated with restaurants:

1. Drive-thru windows are discouraged on any building elevation directly facing a street frontage.

2. *Drive-thru lanes* shall be designed in such a way as to be screened from view from the street through elevation differences, landscaping, arbors, trellises, canopies, walls and other architectural features used to reduce the visual presence of drive-thru operations.

3. Freestanding drive thru restaurants should be located on lots with at least 30,000 square feet, except for drive thru restaurants in master planned integrated commercial complexes with shared parking and access.

4. A minimum five-foot-wide landscaped planter should be installed between the *drive-thru lane* and parking lot maneuvering area when adjacent to one another, as determined necessary on a case-by-case basis.

F. Additional requirements for a business with *drive-thru lane*(s) within the MU-U and MU-V Zones:

1. Drive-thru pick-up windows shall not be located on any building elevation facing a street.
2. *Drive-thru lanes* shall be located at the rear of the building and screened from view from adjacent streets. For corner properties, a combination of walls and other architectural and landscape features, such as arbors, trellises, canopies, and landscape berms may be used to screen the drive-thru lane from one adjacent street. (Ord. 7408 §1, 2018; Ord. 7331 §74, 2016; Ord. 7100 §1, 2010; Ord. 6966 §1, 2007)

Citation 8:

County of San Diego Parking Design Manual

https://www.sandiegocounty.gov/pds/docs/Parking_Design_Manual.pdf

2. Parking Aisles

d. *Drive-Through Aisles*

All projects which feature drive-through facilities (bank, pharmacy, fast-food, etc.) shall provide a *drive-through aisle* capable of a reasonable queuing of vehicles without impeding the circulation of traffic within the parking area or abutting **driveway** or street travel way. *Drive-through aisles* should not cross pedestrian pathways and be clearly designated with striping and/or signage. See the Zoning Ordinance for specifications.

3. Access **Driveways**

The construction, repair, and maintenance of all **driveways**, curbs and gutters, and sidewalks are the responsibility of the property owner, developer, or tenant. The responsibility includes the entire area of **driveway** from the edge of the existing pavement of traveled way to the property line and all culverts or other structures necessary for property drainage control.

A residential **driveway** is any **driveway** serving property used solely as a private single, duplex, or triplex residential dwelling unit, including farms or ranches not used as retail outlets. All other driveways are considered commercial **driveways**. For specifications on residential **driveways**, see Section III D.

All residential and commercial **driveways** designated as a fire access road shall comply with the County's Consolidated Fire Code.

To minimize interference with the flow of traffic and provide optimum access, **driveway** design should also consider:

- line of sight,
- offset to adjacent and opposing **driveways**, and
- proximity to nearby intersections.

Parking facilities should be designed to minimize the number of **driveways** to private property from streets and highways.

Not more than 40% of property frontage on residential lots and 60% of property frontage on non-residential or multi-family residential lots may be allocated for **driveway** curb openings, except for lots with frontage of 50' or less, which are entitled to one 16' **driveway** with a 22' curb opening.

Refer to the County of San Diego Public Road Standards and Standards for Private Roads for additional information.

It seems evident that the legal term "**driveway**" as used by these 8 citations from other California jurisdictions is being used consistent with California Streets and Highway Code § 5870 - and that each of these other 8 California jurisdictions consistently uses the alternate terms such as drive aisle, drive thru aisle, drive thru lane, as definitive descriptors of the features that comprise the access points of a drive thru facility. Therefore, the use of the term "**driveway**" in The Community Design Standards for Parking and Lodging, Section H Subsection 2 (H2), in accordance with California law as established in California Streets and Highway Code § 5870 refer to the four **driveways** directly accessing the project site from the public roadway, Saratoga Way, which each directly face a residential zone, and the project, as designed, is not in compliance with El Dorado County Community Design Standards Parking and Loading Standards Section H, 1-8 Subsection 2.

In the applicant response(s) dated 10-5-18 in the Legistar Calendar files for both appeals, 18-1497 & 18-48 [Applicant Response BOS Rcvd 10-5-18 BOS 10-9-18

<https://eldorado.legistar.com/View.ashx?M=F&ID=6666297&GUID=1E427F86-6C42-4106-866D-76062660785F>] the applicant offers:

"In an effort to find any adopted regulation with which the application is not consistent, the appellants point out that Section H.2 of the Community Design Standards which prohibits siting drive-through facilities on driveways facing residential zones. They argue that since the encroachment on Saratoga Way for the Saratoga Retail Center is facing residentially zoned property it is in violation of this provision. However, careful reading of the provisions associated with drive-through regulations makes it clear that the term "drive-through facility" refers to that portion of the building which contains the window and equipment where the drive-through transaction actually occurs. This is most evident in Section H.1 of the regulations which provides that a drive-through facility shall be located at the rear or side of a commercial structure. Clearly this reference isolates the "facility" to the drive through and does not characterize the entire building or center as the facility, as the appellants would like. The project clearly complies with this requirement by having the driveway serving the drive-through facility directed towards El Dorado Hills Blvd at its point of ingress and towards the Walgreens store at the point of egress."

In this response the applicant ignores the legal definition of "driveway" as established in California Streets and Highway Code § 5870:

Driveway means a **paved portion of a public street providing an unobstructed passage from the roadway to an offstreet area** used for driving, servicing, parking, or otherwise accommodating motor vehicles. [Cal Sts & Hy Code § 5870]

The drive aisles **inside the project, an offstreet area used for driving, servicing, parking, or otherwise accommodating motor vehicles**, are not driveways by California code. In this response the applicant refers to access points from a public roadway (Saratoga Way) as encroachments, but in the original project application the applicant refers to them as driveways. County Planning Staff also refers to these access points as driveways in the original DR09-0003-R as well as in DR-R18-0001/Saratoga Retail Phase 2 Planning Commission/August 23, 2018 Findings.

In the El Dorado County Community Design Standards Parking and Loading Standards Section H.2 the standard mentions both drive-through facilities and driveways – clearly these are meant to mean two distinct items, to wit:

H.2 - Ingress TO and egress FROM a drive-through facility shall be prohibited FROM driveway(s) directly facing a residential zone.

The Applicant defines the drive aisles, stacking area, order point(s), and service window(s) as drive-through facilities. Section H.2 cites drive-through facilities AND driveways, with the requirement that driveways not face residential zoned areas.

The four project driveways as legally defined by California Streets and Highway Code § 5870 are the driveways to access the project from the public roadway, Saratoga Way, and each of these faces a residential zoned area, which leaves the project in noncompliance with El Dorado County Community Design Standards Parking and Loading Standards Section H, 1-8 Subsection 2 (H.2).

EDHAPAC has taken the time to point out this one specific design standard, in which this project fails to be in compliance as currently proposed as one example. Further, it is the duty of County Planning Staff, the Planning Commission, and the Board of Supervisors to uphold and adhere to El Dorado County's municipal ordinances and design standards. But beyond this, EDHAPAC and area residents still have many other valid concerns about this Project at this location – significant negative impacts that the operation of a drive thru restaurant adjacent to homes would have in terms of traffic, noise, air quality, visual blight, crime, and for area residents, the quiet enjoyment of their property.

As with our August 17, 2018 letter to the El Dorado County Planning Commission, EDHAPAC reiterates: Assuming for the sake of argument that the Project proponent has a right to build the Project as presented in regards to existing commercial zoning, it does not mean that it is the right, or responsible thing to do. EDHAPAC volunteers do not seek to "approve" or "deny" any commercial or residential projects – the goal of

EDHAPAC volunteers is to make projects the best fit for our community, which is why EDHAPAC volunteers offered a letter of Non-Support for the project as proposed, to the El Dorado County Planning Commission.

As always, EDHAPAC appreciates the County of El Dorado Board of Supervisors for considering our concerns, and appreciates the assistance provided by Planning Department Staff in our review of this Project, and wishes to thank the Project Applicant and the members of his team for attending the EDHAPAC August 2018 meeting and answering questions about the Project.

Sincerely,

John Davey

John Davey – 2018 EDHAPAC Vice Chair

cc: Read File

8/20/2018

Edcgov.us Mail - Fwd: EDHAPAC_DR-R18-0001_Saratoga_Retail_Phase2_Aug18-2018.pdf

PC 8-23-18
#7
3 Pages



Planning Department <planning@edcgov.us>

Fwd: EDHAPAC_DR-R18-0001_Saratoga_Retail_Phase2_Aug18-2018.pdf

1 message

Char Tim <charlene.tim@edcgov.us>
To: Planning Department <planning@edcgov.us>

Mon, Aug 20, 2018 at 7:51 AM

----- Forwarded message -----

From: **Timothy White** <tjwhitejd@gmail.com>
Date: Sat, Aug 18, 2018 at 11:20 AM
Subject: EDHAPAC_DR-R18-0001_Saratoga_Retail_Phase2_Aug18-2018.pdf
To: Char Tim <charlene.tim@edcgov.us>
Cc: gary.miller@edcgov.us, jeff.hansen@edcgov.us, james.williams@edcgov.us, brian.shinault@edcgov.us, jvegna@edcgov.us, bosone@edcgov.us, bostwo@edcgov.us, bosthree@edcgov.us, bosfour@edcgov.us, bosfive@edcgov.us

Dear Ms. Tim.
Attached please find The El Dorado Hills Area Planning Advisory Committee's Comment Letter on the Saratoga Retail Phase 2 Project.
Please include it as an official Public Comment to File # 18-1215 on the Planning Commission's August 23, 2018 Agenda.
Thank you.

Timothy J. White- EDHAPAC Chair

EDHAPAC_DR-R18-0001_Saratoga_Retail_Phase2_Aug18-2018.pdf
105K



El Dorado Hills Area Planning Advisory Committee

1021 Harvard Way
El Dorado Hills, CA 95762

2018 Board Chair

Tim White

Vice Chair

John Raslear

Secretary

Kathy Prevost

Vice Chair

John Davey

August 17, 2018

The County of El Dorado Planning Commission
The County of El Dorado Board of Supervisors
County of El Dorado Planning and Building Department
El Dorado County Planning Services
2850 Fairlane Court
Placerville, CA 95667

DR-R18-0001 Saratoga Retail Phase 2

The voting members of The El Dorado Hills Area Planning Advisory Committee (“EDHAPAC”) voted unanimously to file a letter of Non-Support for the Project. After reviewing the documents on file for the Project at the Planning Department’s and the Planning Commission’s websites, EDHAPAC believes significant issues regarding traffic, RV parking and design review standards remain, and until those issues are answered and addressed this Project should not be allowed to proceed.

RV PARKING - Mr. Joel Wiley, an experienced RV owner and driver, sent a Public Comment to the Planning Commission raising several concerns regarding both the size of the 2 allocated RV parking spaces and the tight turns necessary to get into and out of those spaces. We suspect that these spaces are designed on a computer in an office, but do the people who do the design have any real-life experience driving and maneuvering an RV? Does any member of Planning Department Staff responsible for reviewing and/or approving the RV parking space layout have any real-life experience driving and maneuvering an RV? Have they ever set up plastic cones in a parking lot with the dimensions of the spaces and turns planned for the Project and tried to maneuver an RV in and out? Is there a State of California, or El Dorado County ordinance addressing the definition, requirements, and design elements of what constitutes an RV parking space?

There are further issues and concerns about the whole RV Parking requirements for the Project that are addressed with great specificity in the Public Comment from 8 neighborhood residents (the “Washburn/Camom Comment”) received by the Planning Commission on August 13, 2018, and those comments adequately reflect the issues and concerns of EDHAPAC, and thus are incorporated herein by reference.

TRAFFIC – Many of the issues and concerns that EDHAPAC has with the traffic that would be generated by a busy and popular drive-thru restaurant located next to a residential neighborhood are

El Dorado Hills APAC - Non-partisan Volunteers Planning Our Future

addressed with great specificity in the Washburn/Camom Comment, and thus those comments are incorporated herein by reference.

Additionally, EDHAPAC finds it extremely “interesting” that there are disparate current condition and near-term condition traffic impact data for 3 different project’s Traffic Study in the immediate area in a 4-year time span, two of which are provided by the same traffic analysis consultant. [DR-R18-0001 Saratoga Retail Phase II, TM14-1520/Z14-0007/PD14-0006 Saratoga Estates, and A16-0001/RZ16-0004/PD94-0004-R El Dorado Hills Apartments]. Those traffic analysis numbers are seemingly tailored differently for each project to achieve a finding of No Significant Impact or Less Than Significant Impact – i.e those numbers and statistics appear to be modeled to achieve a desired result. EDHAPAC also questions whether traffic impacts generated by the Project that exceed Measure E triggers can be mitigated by TIM Fee contributions from multiple other projects that may, or may not, happen at some uncertain, undefined future date.

MITIGATED NEGATIVE DECLARATION- EDHAPAC is concerned and bewildered that Planning Department Staff would prepare a Mitigated Negative Declaration for this Project that does not address (in fact, completely ignores) the County of El Dorado Ordinance governing drive thru facilities. The Community Design Standards for Parking and Lodging, Section H, 1-8 mandates that drive thru facilities SHALL (not “should” or “can” but “shall”) comply with the circulation and traffic control standards set forth therein. Subsection 2. provides that ingress to and egress from a drive thru facility shall be prohibited from driveways directly facing a residential zone. All 4 proposed access driveways for this Project face a Residential Neighborhood- obviously zoned residential! The reason the County of El Dorado mandated the 8 specific compliance standards goes to the heart of the issue with a drive thru restaurant at this location – it is located immediately adjacent to a long-established residential neighborhood, and the County’s intent was and is to protect residential neighborhoods from the intrusiveness of such an establishment.

EDHAPAC has valid concerns about this Project at this location – the nearby residents in the Washburn/Camom Comment have set forth in detail and with specificity legitimate and significant negative impacts that the operation of a drive thru restaurant adjacent to their homes would have in terms of traffic, noise, air quality, visual blight, crime and the quiet enjoyment of their property. Assuming for the sake of argument that the Project proponent has a right to build the Project as presented, it does not mean that it is the right thing to do. To quote G. Guga Mona “It is better to wait until you get the right thing, at the right time and in the right place; than to race for the wrong thing, at the wrong time and in the wrong place...”.

As always, EDHAPAC appreciates the Planning Commissioners for listening to our concerns, appreciates the assistance provided by Planning Department Staff in our review of this Project, and wishes to thank the Project Proponent and the members of his team for attending the EDHAPAC meeting and answering questions about the Project.

Sincerely,
Timothy J. White – EDHAPAC Chair

cc: Read File



Community Design Standards

In accordance with the Zoning Ordinance Update

Parking and Loading Standards

Adopted December 15, 2015

Community Design Standards

Parking And Loading Standards

3. **Elementary, Middle and High Schools.** One bicycle space per student at 25 percent of peak enrollment.
- H. **Drive-through Facilities.** Sites containing these facilities shall be in compliance with the following circulation and traffic control standards:
1. A drive-through facility shall be located at the rear or side of a commercial structure and not within any front setback area.
 2. Ingress to and egress from a drive-through facility shall be prohibited from driveway(s) directly facing a residential zone.
 3. A drive-through facility, including stacking areas for vehicles awaiting service, shall be a minimum of 50 feet from the nearest property line of any residentially zoned lot.
 4. Stacking lane(s) shall be physically separated from other traffic circulation on the site by concrete or asphalt curbing. The stacking lane(s) shall accommodate a minimum of four cars per drive-through window in addition to the car receiving service. The lanes shall be a minimum width of ten feet.
 5. Signage shall be provided to indicate the entrance, exit, and one-way path of drive-through lanes in compliance with Chapter 17.37 (Signs).
 6. Stacking areas shall not block access to any parking area or space required of a business. Lane striping to separate drive-through traffic from parking areas shall be provided from the nearest point of site access, as feasible, to the stacking lane(s).
 7. Where a facility exceeds the standards of Paragraphs 1 through 6 above, and is not located within a development that is subject to a discretionary permit, such as a Conditional Use, Design Review, or Development Plan Permit, a Conditional Use Permit shall be required.
 8. When a drive-through facility requires a Conditional Use Permit or is within a development that is subject to a discretionary permit, the review authority may impose a greater setback than is required under Paragraph 3 above, when it is determined necessary to mitigate impacts from noise, air pollution, lights, or other land use conflicts. The review authority may deny any application for a drive-through facility if it finds that the facility will add to the cumulative air quality impacts for a specified pollutant and the County is found to be in non-attainment status of either federal or state air quality standards for that pollutant.
- I. **Historic Structures.** The following exemptions and reductions in parking standards shall apply to all historic structures, as designated by the County:



STREETS AND HIGHWAYS CODE - SHC

DIVISION 7. THE IMPROVEMENT ACT OF 1911 [5000 - 6794] (*Division 7 added by Stats. 1941, Ch. 79.)*

PART 3. PERFORMING THE WORK [5100 - 5954] (*Part 3 added by Stats. 1941, Ch. 79.)*

CHAPTER 27. Construction of Sidewalks and Curbs [5870 - 5895.54] (*Chapter 27 added by Stats. 1945, Ch. 1339.)*

ARTICLE 1. General Provisions [5870 - 5873] (*Article 1 added by Stats. 1945, Ch. 1339.)*

As used in this chapter:

5870. (a) “Block” means property facing one side of any street between the next intersecting streets or between the terminus of a dedicated right-of-way of a street and an intersecting street. “Street” does not include an alley or other right-of-way unless it is of the same width as a regular residential minimum-width street approved as part of a master plan of circulation or streets by the governmental agency involved. In the case of an alley, “block” means property facing both sides of any alley between the next intersecting streets or alleys, or between the terminus of an alley and an intersecting street. In the case of street lighting, “block” means property facing the side of any street on which the improvement is to be constructed between the next intersecting streets on the side to be improved or between the terminus of a dedicated right-of-way of a street and a street intersecting the side to be improved; or property facing the side of any street on which the improvement is to be constructed between the next intersecting streets on the side to be improved or between the terminus of a dedicated right-of-way of a street and a street intersecting the side to be improved and the property facing the opposite side of the street.

Where a “block” exceeds 1,000 feet in length, a length of frontage of 1,000 feet constitutes a “block” as used in this chapter, if so designated by the superintendent of streets. A determination by the superintendent of streets of such a 1,000-foot block establishes a “block” and cannot later be changed to include a portion of said 1,000-foot “block” in another “block.”

(b) “Driveway” means a paved portion of a public street providing an unobstructed passage from the roadway to an offstreet area used for driving, servicing, parking, or otherwise accommodating motor vehicles.

(Amended by Stats. 1971, Ch. 153.)

Community Design Guidelines

Planning and Redevelopment Department



311 Vernon St.
Roseville, CA 95661
www.roseville.ca.us/planning



Community Design Guidelines for the City of Roseville

Adopted December 6, 1995
Resolution # 95-347

Amended March 19, 2008
Resolution # 08-142

Planning and Redevelopment Department
311 Vernon St.
Roseville, CA 95678

916.774.5276
www.roseville.ca.us

I. Site Design Guidelines

Site planning respects and enhances the natural environment, connects the project to its surroundings, promotes walkability, ensures effective access and circulation, includes green design features, and provides for services and storage.

A. Site Planning and Building Siting

Design Guidelines

CC-1 Buildings should be arranged to define, connect, and activate pedestrian edges and public spaces.

CC-2 Buildings should be arranged to provide convenient access to transit stops.

CC-3 The relationship and orientation of buildings to arterial and other prominent roadways should be considered to enhance street frontage.

CC-4 Consideration should be given to the orientation of service bays, drive-thru lanes, pickup windows, and other utilitarian building functions toward the street.

- If drive-thru lanes must be adjacent to the street, they shall be screened through the use of low walls and/or landscaping.
- If pickup windows must be oriented toward the street, they shall be de-emphasized through screening and/or architectural treatment.

CC-5 Projects on the corners of prominent intersections should be treated as community gateways and should be of the highest design quality.

- Gas station canopies, fast-food restaurants with drive-thrus, and other services should be located away from the corner.
- Corners should be defined with appropriate retail uses and architectural treatment.
- Buildings on Signature Corners should be located at the back of the landscape corridor to provide massing and visual interest to frame the intersection.

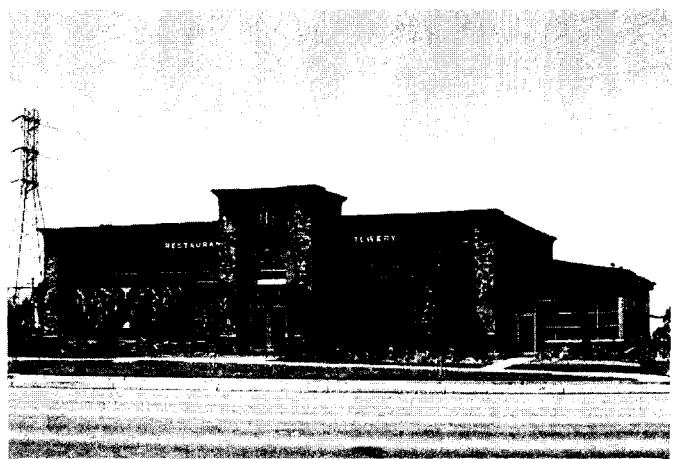

Prominent corner defined by a well-articulated building.

Design Guidelines for Commercial Development

E. Access, Circulation, and Parking

Design Guidelines

CC-23 Vehicular access to the site, internal circulation, and on-site parking should be adequately designed. The following guidelines should also be considered:

- Short term parking for delivery of mail and small parcels that does not impede circulation should be provided.
- Shared access drives between adjacent parcels are encouraged to minimize the number of curb cuts.
- Reciprocal access easements for vehicles and pedestrians, and shared parking facilities between compatible adjacent uses are encouraged.

CC-24 - For larger commercial shopping centers, customer parking behind the main building or buildings is discouraged unless there is convenient access to the store or stores.

CC-26 Shopping cart return areas should be adequate to the size and use of the project and should be conveniently located. Cart return areas shall not eliminate required parking spaces or conflict with pedestrian or vehicle circulation.

CC-27 Paving material for driveways, drive aisles, and walkways should be consistent with the architectural style of the buildings and should incorporate similar accent elements.

- Stamped and/or colored concrete or other decorative accent is encouraged.

CC-28 Site circulation should allow for and facilitate emergency access to the site and all buildings.

- Speed bumps are strongly discouraged as they impede emergency response.
- Long, straight drives are discouraged to prevent speeding, which conflicts with pedestrian safety.

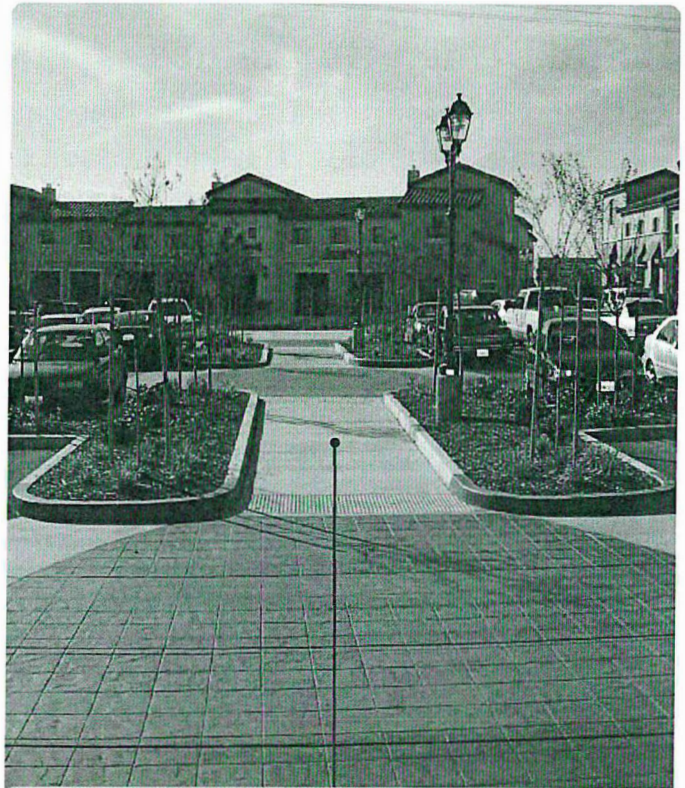

Sidewalk separated from the drive aisle and bordered by landscaping provides safe, convenient, and comfortable path for pedestrians.

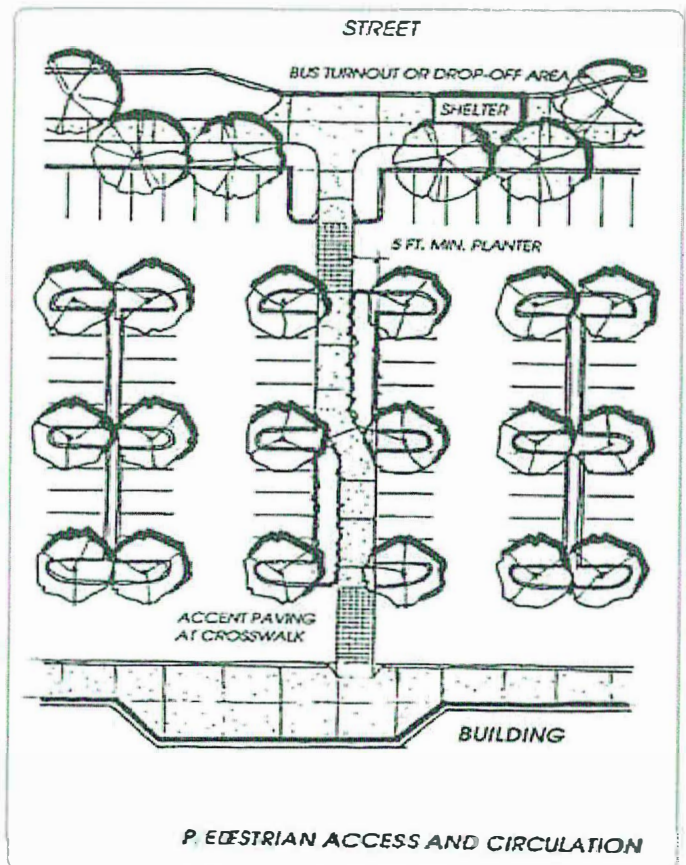

CC-29 Recycling drop off areas, when required by State law, shall comply with the Zoning Ordinance regulations for such areas, and should be conveniently located to encourage their use and avoid conflict with pedestrian and vehicle circulation.

Technical Guidelines

CC-30 Drive through aisles for fast food restaurants shall provide a minimum of 180 feet of stacking distance (measured from the pickup window) that does not conflict with the on-site parking and circulation system. Other similar operations such as car washes and automatic teller machines shall provide a minimum of 100 feet of stacking.

CC-31 Street and drive aisle widths, throat depths, stacking distances, and parking shall comply with current City standards.

- Required number of parking spaces shall be provided, as defined in the Zoning Ordinance.
- Compact parking spaces, when provided, shall not exceed thirty percent of the number of required parking spaces, and should be dispersed throughout the parking lot and not concentrated or grouped in one area.
- All pedestrian circulation walks shall be designed to provide access to the disabled in compliance with the American's with Disabilities Act (ADA), California Title 24 and the City's Improvement Standards.
- Bicycle racks or lockers shall be provided in the quantity required by the Zoning Ordinance and should be located in highly visible and convenient areas.
- Projects that are required to prepare and gain approval of a Transportation Management Plan shall provide the required and optional elements as stipulated in the TSM Ordinance.

CC-32 Sidewalk corridors (i.e., designated pedestrian "spines") in parking lots should have a minimum of five feet of landscaping on at least one side of the walkway or alternating from one side to the other to provide a comfortable walking environment, including shade for pedestrians.

CC-33 Consistent with the Bikeway Master Plan and various specific plans, commercial projects may be required to provide bikeway improvements, including (but not limited to) connections to bike trails, on-street bike lanes, and/or Class 1A trails within the project's landscape frontage.

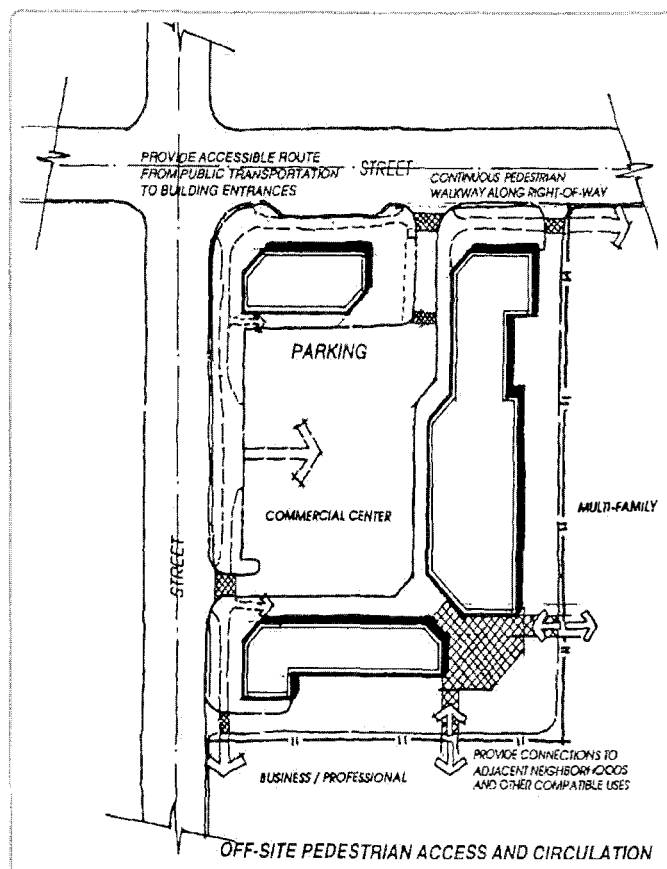

Design Guidelines for Commercial Development

F. Service and Storage

Design Guidelines

CC-34 Consideration should be given to loading, delivery, and transfer of merchandise. Loading areas should be provided when appropriate.

CC-35 Drive-thru lanes adjacent to roadways should be screened from view through a combination of low screen walls ("knee walls"), berming, and landscaping.

CC-36 Services and storage, including garbage collection, recycling, fire, and utilities should be adequately planned.

- Outdoor storage shall be screened from public view through a combination of building design, landscaping and berming, and/or location.

Technical Guidelines

CC-37 Trash enclosure location, dimensions, and design shall comply with current City standards.

- All refuse containers shall be placed within screened storage areas or enclosures.
- Refuse containers should be conveniently located throughout the project, yet sufficiently buffered from project entries, main building entries, and main pedestrian paths.
- Enclosures should be located to provide easy access for users, adequate space for servicing by refuse trucks, and visibility for safe vehicle circulation.
- Enclosure materials and colors should be consistent with, and complimentary to, building materials and finishes.
- A minimum three foot landscape buffer should be provided on all non accessible sides of trash enclosures. A larger buffer area will be required when adjacent to single family residential areas.

CC-38 Perimeter planting areas needed to provide screening should be a minimum of five feet wide.

Architecturally integrated screenwall effectively screens loading dock from street.



Low screen walls and landscaping effectively screen drive-thru from view.

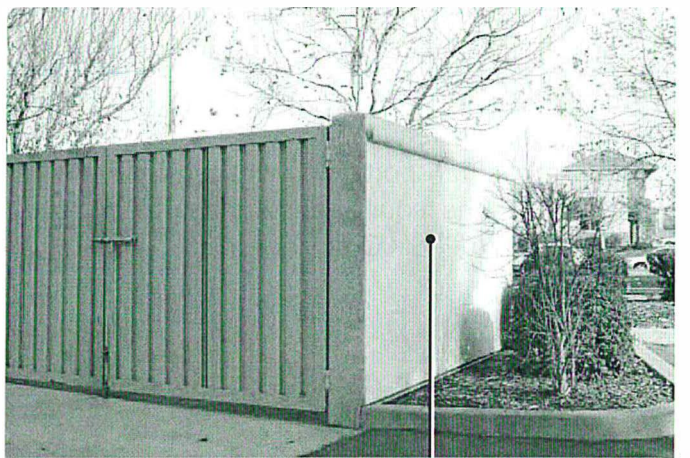

Refuse enclosure material and color is consistent with, and complimentary to, building.

III. Public Space Guidelines

The design of public spaces provides safe, active and accessible gathering places in the community that encourage social interaction and a sense of community.

A. Streetscape Design

Design Guidelines

CC-51* Projects shall address bicycle and pedestrian needs in their design. Options to achieve this include, but are not limited to:

- Providing physical separation from streets and drive aisles through landscaping to encourage walking.
- Providing pedestrian amenities such as appropriate signage, street furniture, landscaping and pedestrian-scale lighting.
- Promoting walkability by providing pedestrian linkages between stores, public spaces, parking areas, and adjacent projects.
- Providing pedestrian pathways through parking lots separated from drive aisles.

CC-52 Streetscape design should include the following elements:

- Primary street trees that provide shade for pedestrians, soften and frame the street, and define the public space.
- Secondary trees that complement and support the primary trees in form and function,
- Accent trees that are used to define entrances, add variety in form and color, or highlighting other focal points of the street.
- Primary, secondary and accent shrubs which are used to form the understory and further define entrances and provide screening of parked cars where necessary.



Technical Guidelines

CC-64 Trees should shade at least 50% of the paved parking areas as measured at 15 year maturity based on the tree species and mid summer sun angle conditions. The shade values for various tree species are located in the specific plan landscape guidelines. Shade calculations shall be made in accordance with the Parking Lot Shade Diagram in Appendix C.

CC-65 Plant materials shall be selected and located to avoid conflicts with the underground or above ground utilities.

CC-66 Trees and shrubs planted at all intersections and driveways shall be selected and located to maintain safe sight line distances per the City's Clear Vision Triangle as defined in the Zoning Ordinance.

CC-68 Tree selection and placement should allow for sufficient root space adjacent to paved surfaces. The following minimum planter widths (measured inside curbs) should be provided:

- Eight feet for large canopy trees (may be reduced to five feet with deep root barriers and irrigation)
- Six to eight feet for medium to large canopy trees
- Six feet for medium to small canopy trees
- Four feet for small canopy trees

CC-69* Planters shall be protected from vehicles by use of raised curbs or wheel stops.

CC-70 Trees should be a minimum of fifteen gallon size. It is recommended that larger sized trees be incorporated for accent or activity areas.

CC-71 Shrubs should be a minimum of one gallon in size; however, a mix of one gallon and five gallon shrubs is encouraged. Screen plantings may require five gallon minimum sizes in order to provide immediate effectiveness. Shrub ground covers may be specified in either liner or one gallon sizes.

CC-72 Landscape plans should be prepared by a licensed landscape architect and shall be prepared in accordance with the Water Efficient Landscape Requirements.

CC-73 Slopes for landscaped areas should not exceed three to one, and the minimum slope shall be two percent.

CC-74 The protected zone of native oak trees located in landscaped areas shall be treated with a bark or other appropriate organic groundcover.

CC-75 The top and toe of slopes within landscaped areas shall be setback a minimum of two feet from fences, walls, property lines, street curbs, pedestrian/ bike paths or other hardscape surfaces in order to prevent drainage across these surfaces.

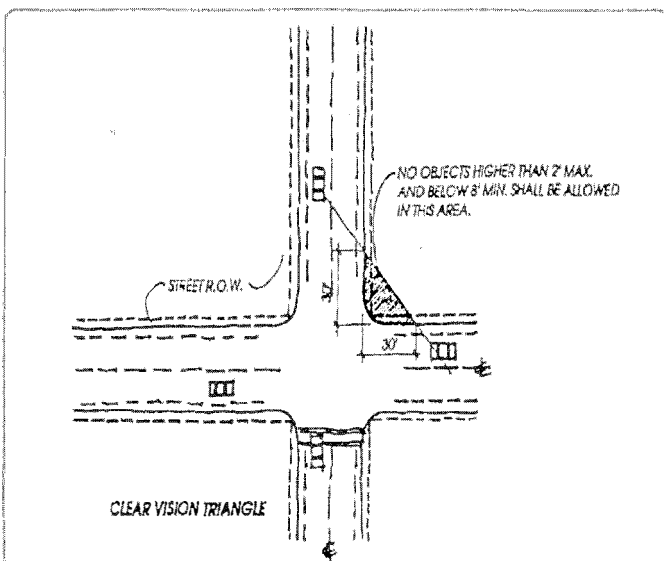

Design Guidelines for Office and Industrial Development

D. Green Site Design

Design Guidelines

OI-18 Consistent with the City's Stormwater Treatment Manual, surface water and pollutant runoff should be reduced by maximizing the use of pervious surfaces and vegetative ground cover.

- Use of permeable paving, pavers, turf stone, brick, and decomposed granite is encouraged.
- Use natural topographic features or built swales for site drainage, provide pervious or semi-pervious pavement, etc.

Technical Guidelines

OI-19 Roof drains and parking lot run-off should be routed through turf or other landscaping to treat storm water runoff and allow percolation.

Surface water and pollutant runoff is reduced by maximizing the use of pervious surfaces and vegetative ground cover

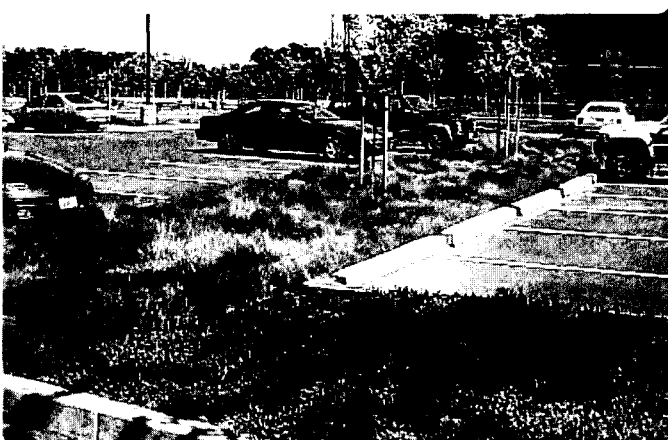

E. Access, Circulation, and Parking

OI-20 Vehicular access to the site, internal circulation, and parking lot designs should consider the following:

- Short term parking for delivery of mail and small parcels that does not impede circulation should be provided.
- Shared access drives between adjacent parcels are encouraged to minimize curb cuts.
- Reciprocal access easements for vehicles and pedestrians, and shared parking facilities between compatible adjacent uses are encouraged.
- Drive through aisles for automatic teller machines shall provide a minimum of 100 feet of stacking distance that does not conflict with the on-site parking and circulation system.
- The determination of adequate stacking for project entry driveways shall account for security gates, checkpoints and guard shacks if applicable.
- Conflicts between truck traffic and employee and visitor parking should be minimized.

OI-21 Office and Industrial site design should promote walkability and pedestrian linkages between stores, public spaces, and adjacent projects.

- Pedestrian pathways through parking lots separated from drive aisles are highly encouraged.

OI-22 Paving material for driveways, drive aisles, and walkways should be consistent with the architectural style of the buildings and should incorporate similar accent elements.

- Stamped and/or colored concrete or other decorative accent is encouraged.

OI-23 Site circulation should allow for and facilitate emergency access to the site and all buildings.

- Speed bumps are strongly discouraged as they impede emergency response.
- Long, straight drives are discouraged to prevent speeding and conflicts with pedestrians.

Design Guidelines for Office and Industrial Development

F. Services and Storage

Design Guidelines

OI-28 Loading docks and service areas should be screened from public view and adjacent incompatible land uses by a combination of building design and/or layout, masonry walls, grade separations and/or dense landscaping.

OI-29 Drive-thru lanes adjacent to roadways should be screened from view through a combination of low screen walls ("knee walls"), berming, and landscaping.

OI-30 Services and storage, including garbage collection, recycling, fire, and utilities should be planned.

- Outdoor storage shall be screened from public view through a combination of building design, landscaping and berming, and/or location.
- Perimeter planting areas needed to provide screening should be a minimum of five feet wide.

Technical Guidelines

OI-31 Trash enclosure location, dimensions, and design shall comply with current City standards.

- All refuse containers shall be placed within screened storage areas or enclosures.
- Refuse containers should be conveniently located throughout the project, yet sufficiently buffered from project entries, main building entries, and main pedestrian paths.
- Enclosures should be located to provide easy accessibility for users, adequate room for servicing by refuse trucks, and should not hinder visibility for vehicle circulation.
- Enclosure materials and colors should be consistent with, and complimentary to, building materials and finishes.
- A minimum three foot landscape buffer should be provided on all non accessible sides of trash enclosures. A larger buffer area will be required when adjacent to single family residential areas.



Service bays with roll up doors are oriented internally and away from the street frontage.



Drive-thru lane and pick-up window screened from view.

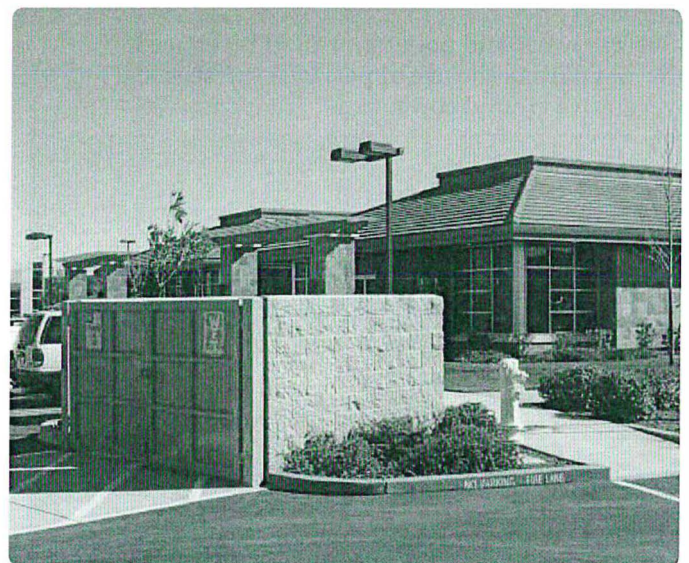

Parking Lot Shading Requirements

Parking lot areas subject to the 50% shading requirement are as follows:

1. Parking stalls;
2. All vehicular back up areas.

Parking areas not subject to the shading requirement include:

1. Truck loading areas in front of overhead doors;
2. Truck maneuvering and parking areas separate from other vehicle parking areas;
3. Driveways;
4. Surfaced areas not accessible for vehicle parking, driving or maneuvering;

Shading requirements shall be calculated as follows:

1. Shade shall be calculated according to the percentage of shade coverage of the canopy, determined by the location of the tree within the parking lot. Refer to the parking lot shading diagram.
2. The shade percentage figures are based on the canopy spread of the tree 15 years from planting. The tree is assumed to be planted from 15 gallon containers.
3. Overlapping shade is not calculated twice. Therefore, spacing trees closer than their designated spread will not provide more shade value.

Example of Shade Calculation

Tree	Interior Planter - 100%	South, East and West - 50%	Corner and North - 25%
Celtis sinensis	3 x (962) = 2,886	NA	NA
Lagerstroemia indica	NA	5 x (157) = 785	NA
Magnolia grandiflora	NA	2 x (481) = 962	2 x (240) = 480
Pyrus calleryana	NA	2 x (354) = 708	2 x (177) = 531
Calculated Total	2,886+	2,455 +	1,011 = 6,352

Required Total
Area of Paving: 12,422 square feet

Area required to be shaded: 12,422 x 50% = 6,211 square feet 6,352 > 6,211
Shade provided exceeds amount required. Thus, shading requirements are satisfied.

Chapter 23.78 DRIVE-IN AND DRIVE-THROUGH FACILITY

Sections:

23.78.010 Purpose and applicability.

23.78.020 Permit requirements.

23.78.030 Development standards.

23.78.010 Purpose and applicability.

The purpose of this chapter is to regulate drive-in/drive-through facilities with development standards to ensure that the design and operation of such uses effectively mitigate associated problems with traffic, congestion, excessive pavement, litter, and noise. [Ord. 23-2014 §3 (Exh. A), eff. 10-10-2014; Ord. 26-2006 §3, eff. 8-11-2006]

23.78.020 Permit requirements.

Drive-in/drive-through facilities are permitted or conditionally permitted in designated zoning districts as described in Division III, Zoning Districts, Allowable Uses, and Development Standards, of this title. [Ord. 23-2014 §3 (Exh. A), eff. 10-10-2014; Ord. 27-2013 §14, eff. 2-7-2014; Ord. 26-2006 §3, eff. 8-11-2006]

23.78.030 Development standards.

The development standards in this section are intended to supplement the standards in the underlying zoning district for drive-in and drive-through uses. In the event of conflict between these standards and the underlying zoning district standards, the provisions of this section shall apply.

A. Drive-Through Aisles. The minimum standards for drive-through aisles are as follows:

1. Drive-through aisles shall have a minimum ten (10' 0") foot interior radius at curves and a minimum twelve (12' 0") foot width.
2. Drive-up windows and remote tellers shall provide at least one hundred eighty (180' 0") feet of stacking space for each facility, as measured from the service window or unit to the entry point into the drive-up lane. Nonfood and/or nonbeverage businesses may reduce the stacking space to a minimum of sixty (60' 0") feet.
3. Each drive-through entrance/exit shall be at least fifty (50' 0") feet from an intersection of public rights-of-way, measured at the closest intersecting curbs, and at least twenty-five (25' 0") feet from the curb-cut on an adjacent property. Exceptions may be granted by the designated approving authority when drive-through pull-out spaces are provided.
4. Each entrance to an aisle and the direction of traffic flow shall be clearly designated by signs and pavement markings.
5. Each drive-through aisle shall be separated from the circulation routes necessary for ingress or egress from the property, or access to a parking space.

6. See EGMC Section 23.42.060 (Rural commercial combining zone) for additional development standards for projects within the rural commercial combining zone.

B. Landscaping of the Drive-Through Aisle. Landscaping shall be provided as described below:

1. A five (5' 0") foot-wide planter between the drive-through aisle and the parking area that includes shade trees consistent with those used in the parking area (see EGMC Chapter 23.54, Landscaping).
2. A minimum three (3' 0") foot-tall, maximum four (4' 0") foot-tall planter with low shrubs that screens the drive-through aisles from the abutting public right-of-way shall be used to minimize the visual impact of readerboard signs and directional signs. At no time shall this landscape barrier be pruned in a manner that allows the vehicle headlights from the drive-through lane to be visible from abutting street rights-of-way. Plantings should also be designed to discourage potential safety issues (e.g., persons lying in wait) (see Figure 23.78-1).

C. Pedestrian Access and Crossings. Pedestrian access shall be provided from each abutting street to the primary entrance with a continuous four (4' 0") foot-wide sidewalk or delineated walkway. Pedestrian walkways should not intersect the drive-through drive aisles, but where they do the walkways shall have clear visibility and shall be delineated by textured and colored paving (see Figure 23.78-1).

Figure 23.78-1

Drive-Through Site Design

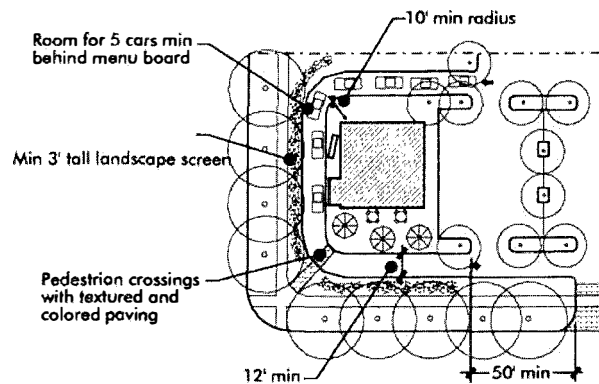

D. Hours of Operation. When located on a site within one hundred (100' 0") feet of any residential property (measured from the nearest property lines), hours of operation for the drive-up/drive-through service shall be limited from 7:00 a.m. to 10:00 p.m. daily. If the use is located greater than one hundred (100' 0") feet from a residential use, then there are no restrictions on the hours of operation. The designated approving authority may grant exceptions through a conditional use permit after preparation of a qualified noise study.

E. Signs. Signs shall be permitted in accordance with the provisions of EGMC Chapter 23.62, Signs on Private Property. Double drive-through aisles shall be restricted to two (2) menu/order board signs.

F. Parking. The provision of drive-through service facilities shall not justify a reduction in the number of required off-street parking spaces for the accompanying use.

G. Noise. Any drive-up or drive-through speaker system shall emit no more than fifty (50) decibels and at no time shall any speaker system be audible above daytime ambient noise levels beyond the property lines of the site. The system shall be designed to compensate for ambient noise levels in the

immediate area. [Ord. 24-2015 §11 (Exh. I), eff. 2-12-2016; Ord. 23-2014 §3 (Exh. A), eff. 10-10-2014; Ord. 16-2009 §3, eff. 9-25-2009; Ord. 26-2006 §3, eff. 8-11-2006]

[Home](#) [<](#) [>](#)

The Elk Grove Municipal Code is current through Ordinance 16-2018, passed August 22, 2018.

Disclaimer: The City Clerk's Office has the official version of the Elk Grove Municipal Code. Users should contact the City Clerk's Office for ordinances passed subsequent to the ordinance cited above.

City Website: <http://www.elkgrovecity.org/>

City Telephone: (916) 691-2489

[Code Publishing Company](#)

[Title 17 PLANNING AND DEVELOPMENT CODE](#)

[Division II ZONING DISTRICTS AND LAND USE REGULATIONS](#)

[Chapter 17.228 SPECIAL USE REGULATIONS](#)

[Article I. General](#)

17.228.109 Drive-through restaurant.

A. Findings. A conditional use permit shall not be granted for a drive-through restaurant unless the decision-maker, in addition to the findings required by section [17.808.200](#), makes the following additional findings:

1. The design and location of the drive-through restaurant service facility will not contribute to increased congestion on public or private streets or alleys adjacent to the subject property.
2. The design and location of the drive-through restaurant service facility will not impede access to or exit from the parking lot serving the business, impair normal circulation within the parking lot or impede pedestrian movement properties.

B. Development standards. The development standards in this subsection B shall be used to analyze the adequacy of the design of a drive-through restaurant.

1. A minimum stacking distance of 180 feet shall be provided to each pick-up window or automated machine.
2. A drive-through restaurant service facility with a separate ordering point and pick-up window shall provide stacking space for at least four vehicles in advance of each ordering point and stacking space for at least four vehicles between each ordering point and pick-up window.
3. Entrances to drive-through lanes shall be at least 25 feet from driveways entering a public or private street or alley.
4. A drive-through restaurant service facility shall not be considered as justification for reducing the number of required parking spaces.
5. The minimum width of each drive-through lane is 11 feet. The entrance to the lane and the direction of traffic flow shall be clearly designated by signs and pavement marking or raised curbs.
6. Operation of the drive-through restaurant service facility is restricted to the hours between 7:00 a.m. and 10:00 p.m. when the site is contiguous to residentially zoned or used property, unless the decision-maker approves different hours of operation as a condition of approval of the conditional use permit.

C. Guidelines. The guidelines in this subsection C shall be used in analyzing the adequacy of the design of the drive-through restaurant. The decision-maker may require redesign of a drive-through restaurant to comply with these guidelines.

1. Public address speakers, on-site lighting, and drive-through lanes shall be designed and located such that noise, exhaust fumes, and stray light shall not unreasonable impact adjacent properties.
2. Placement of a canopy over the pick-up window is desirable to protect the customer from inclement weather. However, the canopy cannot be used as justification to reduce the amount of required on-site shading.
3. Interior landscaping shall be installed on the site to offset the extensive pavement area devoted to the drive-through lane. (Ord. 2013-0020 § 1; Ord. 2013-0007 § 1)

CHAPTER 3

COMMERCIAL AND COMMERCIAL MIXED USE

PURPOSE	3:1
ORGANIZATION	3:1
APPLICABILITY AND USE TYPES	3:2
• Commercial and Commercial Mixed Use	3:3
• Village Center Mixed Use	3:4
• Local Town Center Mixed Use	3:5
• Regional Town Center Mixed Use	3:6
• Transit-Oriented Town Center Mixed Use	3:7
SITE DESIGN	3:8
• Circulation	3:10
• Public Spaces and Pedestrian Amenities	3:14
• Building Placement and Orientation	3:18
ARCHITECTURE	3:22
• Massing, Scale, and Form	3:24
• Style and Design Details	3:26
• Style and Design Details > Commercial Facades	3:28

2. Automobile dependent land uses (e.g. car lot sales lots, gas stations, drive-up restaurants and other drive-up facilities) should be designed to reduce conflicts with pedestrians, by the following means:

- Place the building at the building setback line with an entry from the public sidewalk to help define the “street edge” and encourage pedestrian access (e.g. to a convenience store, restaurant, or a car dealer showroom);
- Create a direct pedestrian connection between public sidewalk and pad building entries without crossing a drive through lane;
- Place the drive through area away from pedestrian areas.

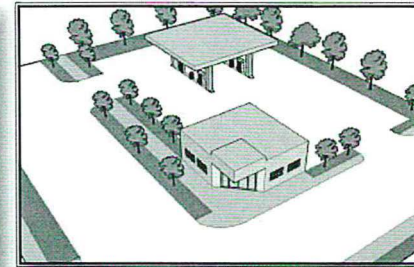
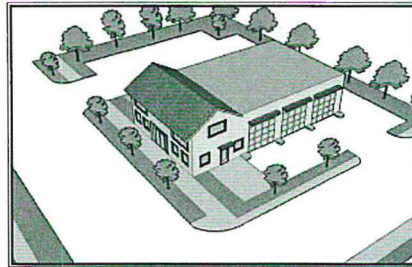

Preferred orientation and site design for auto-dependent uses. The store portion of the project is placed along the street, while service bays and carports are placed at the rear, making them less dominating from the street.

3. Commercial centers should be linked to the surrounding area with pedestrian connections. This includes connecting the internal circulation to the City’s sidewalks and creating connections between uses in other ways, such as paths to neighboring development. Where such connections are made,



The Davis Commons project in Davis, California has several pedestrian connections to the surrounding residential neighborhood. Pathways are enhanced with landscaping, making them attractive to pedestrians.

the paths should be well lit and visible. Paths should not pass through the service areas of the site, as these are often deserted.

4. For *Transit-Oriented Town Centers*, the transit stop shall be an integrated portion, even a focal point, of the development. The development should be treated as though it could not survive without the transit stop.



- Pedestrian crossings of vehicular driveways without adequate protections.
- Dangerous street crossings between transit stops and activity centers.

DESIGN STANDARDS

Pedestrian connections shall be provided between buildings and adjoining commercial and residential sites. The project's sidewalk/walkway network shall connect to the public sidewalk system at a minimum of one point along each street frontage.

SITE DESIGN > PUBLIC SPACES AND PEDESTRIAN AMENITIES

DESIGN OBJECTIVE

Provide usable public spaces and gathering spaces oriented towards the pedestrian user as a key component of the development.

DESCRIPTION

Development should be pedestrian oriented, featuring design components and amenities that are specifically for pedestrians and connect the pedestrian with all aspects of the site and surrounding uses. Additionally, public



Do This: This pedestrian path at Santana Row, San Jose, California cuts through the building. Inside, there are areas for pedestrians to sit, relax, and people watch. The design is attractive and draws people through the opening to the other side.



Don't Do This: This "pedestrian area" is located in the middle of the parking lot and provides very little shade or other amenities. It is disconnected from the active pedestrian areas of the site. It serves no general purpose other than decoration, making it meaningless to the visitor.

spaces, including gathering spaces should be provided. Outdoor areas should be aesthetically pleasing and promote greater activity in commercial areas.

DESIGN GUIDELINES

1. Large sites should feature plazas, greens, or gardens where people can gather. Public spaces shall be meaningful places that contribute to the overall sense of place and site identity and help to attract pedestrian users to the development.
2. Uses such as restaurants should front onto plazas and are encouraged to use the public area of the plaza for outdoor seating and/or dining.
3. Landscape outdoor areas with visually stimulating soft- and hardscape that helps to identify the site. Street furniture, such as benches, lamps, and landscape planters should be integrated as appropriate.
4. Street corners should be developed with buildings entrances, public plazas, or small parks that make it an active portion of the development. Special attention is paid to the design of project and building corners as an opportunity to create visual interest and invite activity.



The scale of the light fixtures, landscaping, the availability of seating areas, and wide sidewalks/paths make this an attractive pedestrian area in Emoryville, California.



Davis Commons in Davis, California is located at the intersection of several major streets. The development has treated the corner as a unique opportunity by having shops front onto the corner and providing a public space between the roadway and the buildings. The plaza features a green space, patio area with moveable seating, adequate lighting, and landscaping that complements and enhances the pedestrian experience.

5. Use different materials and colors to offset the paving and to provide visual interest.

AVOID

- Seating areas adjacent to loading, service bays or storage areas.
- Seating areas that are hidden, secluded, and dark or unsecured spaces behind or on the side of buildings.

DESIGN STANDARDS

A minimum of one public plaza or similar gathering place is required for each center or commercial project. Scale and improvements for such public space should be appropriate to the site, building, and use.



The Bay Street development in Emeryville, California includes a pedestrian plaza with seating and landscaping. It is an inviting feature of the development.



SITE DESIGN > BUILDING PLACEMENT AND ORIENTATION

DESIGN OBJECTIVE

Design and construct buildings to create safe, pleasant, and active environments.

DESCRIPTION

Buildings should be sited and oriented close to the street with inviting and detailed elevations to strengthen the desired image for the area. Only active building elevations with public access should face the street. Buildings



Do This: Example of a commercial development in downtown Walnut Creek, California that creates an interesting and inviting pedestrian environment. Buildings are close to the street at a scale that respects the user. Landscaping softens the architecture. Parking, a major concern of developers and shop-owners, is provided on the street, behind the buildings, or in parking structures that are integrated into the project's buildings. (Courtesy LPA)



Don't Do This: The Laguna Gateway shopping center in Elk Grove, California has buildings set back large distances from the roadways and internal circulation system of the site. Pedestrians must cross parking fields to get between stores. Entrances are oriented toward autos, not people, as evidenced by the sidewalk that terminates into a landscaping planter.

should be sited to create outdoor spaces with amenities for the pedestrian user. On corner sites, building entrances should face the intersection and “communicate” with the neighboring properties. “Main Street” site plans or development are encouraged for larger centers. The proper placement of buildings along a frontage can create interesting and significant opportunities for unique public spaces, inviting pedestrian connections, and can help in establishing a design theme for a streetscape. Consider these issues when siting buildings.



This pad building at 19th and S Streets in Sacramento is located close to the street and includes pedestrian amenities (the trellis work) that connect it to the sidewalk. The trellis includes seating areas for pedestrians and appropriate landscaping to soften the appearance of the site.

1. Where feasible and desirable, commercial buildings for projects over 15 acres in size should be located to create a “Main Street” environment by fronting along the street or internal circulation routes.
2. As vibrant mixed-use sites, commercial buildings should be sited and designed to attract and captivate the pedestrian user. Effective methods of building placement and orientation include:
 - Front doors of commercial buildings shall orient front doors to streets or pedestrian-oriented “main street” style roads (public or private streets);
 - For ground floor commercial uses, design and construct a primary building entrance for each building façade. If a building has frontage on more than one public street, a single building entrance on the corner is acceptable;
 - Use the area between the right-of-way and building to create a plaza court, planter area, bicycle parking, or another amenity (storage and utilities prohibited);
 - Avoid excessive setbacks that create gaps or voids along the street’s architectural edge;
 - Building frontages detailed with architectural elements oriented to the pedestrian along the ground floor.

3. Loading and delivery service areas should be located and designed to minimize their visibility, circulation conflicts, and adverse noise impacts to the maximum feasible extent. They should be screened with portions of the building, architectural wing walls, freestanding walls, and landscaping. They should not be located in required setback areas.

DESIGN STANDARDS

The City seeks to create rich, inviting, pedestrian oriented urban streetscapes as part of its commercial development, especially in a "Main Street" pattern. To accomplish this, the front and street side building setbacks have been modified, as described in the table below, based on project size. The distance is measured from the back of curb of the ultimate right-of-way width. A minimum of 50 percent of this setback envelope shall be occupied by either a primary building frontage (having the main entrance(s) to the building) or pedestrian feature(s). In no instance shall on-site parking or drive-thru aisles be located within this setback, however on-street parking, subject to review by the Public Works department, may be provided. Drive aisles connecting the parking areas to the public street are allowed in the setback area. The setback area may include landscaping or other pedestrian amenities as described in this document or the City Zoning Code. The design review authority may grant exemption when the intent is met by unique development features or there are unique site characteristics or patterns that preclude such action.

Development Size (acres)	Setback Envelope for Primary Building Frontages (from all streets in feet)
0-15	0 to 30
Greater than 15	0 to 80

4. Corner and mid-block pad buildings should be oriented towards the street and public sidewalk and shall meet the following requirements:
 - Drive-thru windows, driveways, and parking shall not be designed in a manner that isolates the building from the sidewalk or connecting walkways.
 - Service windows and stacking lanes for drive-thru business shall not face public streets. Rather, orient automotive service bays away from public streets. The intent is that service bays should not dominate the public street frontage.



This commercial building in Brea, California is oriented close to the street. The entrance is situated at the corner, making it visible and accessible from both streets.

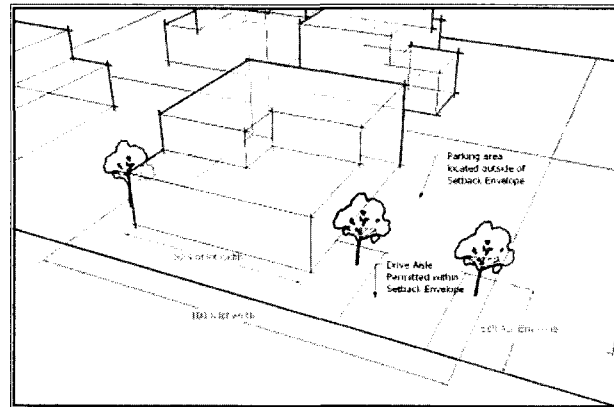

This figure illustrates the design standards describing setback envelope. A minimum of 50 percent of the setback envelope must contain the primary building frontage and/or pedestrian features (see standard on opposite page).

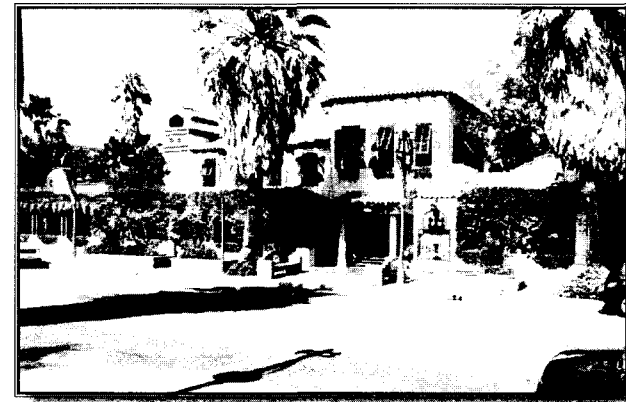

A restaurant in Palm Springs, California. The building is close to the street, patio seating is open to the street while still secluded behind landscaping.

ARCHITECTURE

Intent – Promote architectural design that establishes project identity and enhances the character of Rancho Cordova. Allow various development types to be used with an overall effect of cohesiveness and pleasant built environment as a result.

The Architecture section features the following categories:

- Massing, Scale and Form
- Style and Design Details





ARCHITECTURE > MASSING, SCALE, AND FORM

DESIGN OBJECTIVE

Commercial and mixed-use structures should be designed to a human scale, help create vibrant activity areas, and should complement adjoining properties.

DESCRIPTION

Development should be compact, made up of multi-story structure(s) that concentrate activities. Building height and massing should consider the context of surrounding development. Development should take the human scale into consideration. There should be variety in forms for visual and physical interest.



Do This: Commercial uses in Brea, California. The larger tenants have a mass and scale that respects the smaller tenants.



Don't Do This: This commercial building has little facade articulation and appears as one massive building. It ignores the human user.

DESIGN GUIDELINES

1. Multi-level mixed-use buildings are strongly encouraged. When this occurs, the buildings should be made visually interesting with the following effects:

- Building design which has a visually distinct “base” and “cap”;
- Upper-story elements which overlook the street (balconies, windows, terraces);
- Easy access to the second story to encourage multi-level commercial or office use; and
- Separate entrances for residential uses.

2. Freestanding “big box” building design are discouraged. Rather, the City encourages the integration of large retailers into multi-tenant, integrated developments for a concentration of activity. Where such buildings are independent of other commercial structures, the following techniques shall be used to avoid the long blank walls inherent with this building type:

- Integrate stores into in-line shops (preferred);
- Wrap walls with storefront buildings (preferred);
- Use landscaping to soften and screen blank walls; or
- Employ the technique in Guideline 1 above.



The Village Center at 19th and S Streets in Sacramento successfully illustrates the concept of base-middle-cap. The base of the structure is accented with a stone material. The mid section is brick, and the top is stucco.

ARCHITECTURE > STYLE AND DESIGN DETAILS

DESIGN OBJECTIVE

Commercial development shall be designed with an architectural style or theme that establishes a clear, interesting project identity that will contribute to an enhanced character for Rancho Cordova. The architectural style shall be evident on all elevations of all buildings.

DESCRIPTION

Architectural styling and detailing adds character to a site. Architecture integrates a project into the urban framework and helps to create a sense of place and belonging for the development. While the City is not



Do This: The Carlton Hotel in Atascadero, California. The building has been remolded and restored with a timeless architectural style that respects the history of the building and the city.



Don't Do This: A commercial project in Folsom, California. The street-facing façade is blank and cold. There is no visibility into the buildings from the street or from the buildings to the street. The structure lacks visual interest and architectural character.



advocating a single predominant architectural style to be used throughout the City, the goal is to celebrate diversity of architectural styles while taking the built and natural context and surroundings into consideration. The architecture of a project should be timeless and establish project identity.



DESIGN PROVISIONS

1. Design all sides of the building with consistent architectural and façade elements:

- Break up the roofline silhouette through the use of large cornices, changes in parapet heights or other techniques;
- Use awnings, bulbouts, reliefs, and fenestrations to add distinction to the façade of the structure;
- Roofing should be unique and add character and style to the building.



AVOID

- Visible security grills at windows and door (discreet or retractable security grills may be acceptable).
- False fronts, applied mansard forms, and other artificial rooflines
- Dark tinted glass and mirror-like films

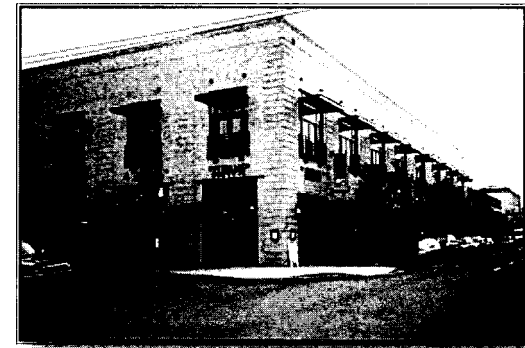

A grocery store in the Belmont Dairy building in Portland, Oregon. The awnings, windows, and other iron work, are details that help accent the building.



ARCHITECTURE > STYLE AND DESIGN DETAILS > COMMERCIAL FACADES

DESIGN OBJECTIVE

Commercial facades should appear open, inviting, and engaging to the passerby.

DESCRIPTIONS

Building facades should be transparent and provide visually interesting environment. Facades should engage pedestrians and help create interest and activity in front of shops to encourage pedestrians to continue along



Do This: This restaurant space in Sacramento, California has a highly accentuated entrance that is clearly delineated from other parts of the building. An awning/trellis is provided over the entrance, the space is recessed from adjoining portions of the building, windows and doors are well trimmed, and the entire length of the façade is made up of windows or glass doors, making the space visible from the public realm and vice-versa.



Don't Do This: Commercial development in Rancho Cordova, California. The design of the overhangs does not place an emphasis on the primary entrances to the building and facilitate easy pedestrian access. There is no architectural focus.

storefronts. Commercial building frontages should provide a sense of continuity and enclosure to streets and internal drives, creating a human-scale “street wall.” Buildings should be designed to provide visual interest, order, and clarity to building fronts. The visual quality of commercial structures can be enhanced with simple architectural and building details that add character and interest while providing a human scale.

1. Storefronts should promote a sense of entry into the structure as well as a sense of shelter by providing:
 - Weather protection on building facades adjacent to walkways with overhangs, canopies, awnings, and recesses;
 - Transparent surfaces (windows) that allow views into and out of buildings with at least 80 percent light transmission (in terms of window tint);
 - Large footprint retail stores lined with multiple narrow retail storefronts.
2. Design entries to be clearly visible from the street and provide visual interest, as follows:
 - Provide a building entrance for every commercial building elevation serving as a primary façade or adjacent to a street with a horizontal dimension of more than 100 feet;
 - Main building entries shall be accented with strong architectural definition to attract pedestrians. They should be accentuated from the overall building façade by:
 - › Differentiated roof, awning, or portico;
 - › Use trim details to accentuate the opening;
 - › Project or recess entries from their surrounding building façades;
 - › Detailed doors and doorway with: ornate hardware, transoms, sidelights, trim details, and framing;
 - › Use windows within entry doorways equivalent in size to 50 percent of door surface area;
 - › Providing decorative nighttime lighting.
 - Secondary entrances should have minor detailing that adds architectural distinction to that portion of the façade. Space entries in larger buildings at appropriate intervals for the pedestrian.

3. Use windows to create an open and inviting atmosphere, as follows:

- Ground floor storefront glazing (windows or display windows) along the primary public façade should comprise a minimum of 50 percent of the main floor's exterior wall area;
- Multiple windows should be provided on the front façade above the main floor in a uniform pattern.
- Window should be oriented vertically with rectangular shapes;
- Frame openings with trim around windows and doors or recess the window a minimum of 4 inches from building façade;
- If used, door and window shutters should be sized to cover the entire window;
- Use sliding, overhead or other operable windows for restaurants or other active uses.

AVOID

- Solid metal or wood doors with small or no windows
- Doors flush with building façade, lacking trim detail
- Unpainted metal frames
- Tinted or reflective glass and glass block
- Windows too small to provide views



A Home Depot in Ft. Collins, Colorado. The entrance to the nursery is treated in a unique way with an accent structure and signage.



The Kohl's department store in North Natomas, Sacramento, California is an example of a commercial project that has windows along the store front to create an open and inviting atmosphere.

Sec. 106.42.080. - Drive-Through Facilities

Where allowed by Article 2 (Zoning Districts and Allowable Land Uses), drive-through facilities shall comply with the requirements of this Section.

A. *General standards.*

1. *Design objectives.* A drive-through facility shall be designed and operated to mitigate problems of congestion, excessive pavement, litter, and noise.
2. *Limitation on location.* A drive-through facility shall be planned and designed to minimize its visibility from a public right-of-way.
3. *Screening.* The drive-through aisle and stacking area shall be screened from the view of the street by a combination of decorative low walls, berming, and landscaping, as determined by the review authority.

B. *On-site circulation standards.* A drive-through facility shall be provided internal circulation and traffic control as follows:

1. *Drive-through aisle design.*
 - a. The entrance and exit of a drive aisle shall both be a minimum of 25 feet from any driveway providing access to the site from a public street.
 - b. Each drive aisle shall be designed with a minimum 10-foot interior radius at curves and a minimum 10-foot width.
2. *Stacking area.* A clearly identified area shall be provided for vehicles waiting for drive-through service that is separated from other on-site traffic circulation on the site.
 - a. *Location.* A stacking area shall not be located adjacent and parallel to a street or public right-of-way, unless the review authority determines that there is no feasible alternative.
 - b. *Capacity.* A drive-through aisle that provides access to a service window shall be designed to provide the following length of stacking space, measured from the service window to the entry point into the drive-through lane.
 - (1) *Restaurants.* An aisle accessing a food service window (ordering or pickup, whichever occurs first in a drive through aisle) shall be designed to provide at least 120 feet of stacking space.
 - (2) *Other retail and service businesses.* An aisle accessing a retail pick-up or service window for a business other than a restaurant shall be designed to provide at least 80 feet of stacking space.
 - (3) *Additional stacking area.* The review authority may require stacking area in addition to that required by Subsections B.2.b(1) and b(2) where it determines that the proposed use will generate more customer vehicle

traffic than the above requirements will accommodate.

- c. *Traffic control.* A stacking area shall be separated from other traffic by concrete curbing or landscaping on at least one side of the lane.
 3. *Exceptions.* The review authority may approve alternatives to the requirements of Subsections B.1 and B.2 where it first finds that the alternate design will, given the characteristics of the site, be equally effective in ensuring on- and off-site pedestrian and vehicular traffic safety and minimizing traffic congestion.
- C. *Building design.* The review authority shall require that the proposed building:
1. Incorporate architectural features that clearly identify pedestrian entrances to buildings, and provides safe and convenient pedestrian access to the entrances;
 2. Use upgraded building materials and design as necessary to offset the negative influence of the additional pavement on overall project appearance;
 3. Include a canopy or trellis-like feature over ordering and pick-up windows; and
 4. Include an outdoor seating/plaza area for food consumption.
- D. *Landscaping.* The review authority shall require on-site landscaping it determines is necessary to offset the extensive pavement devoted to auto use on the site.
- E. *Signs.* Each entrance to, and exit from a drive-through aisle shall be clearly marked to show the direction of traffic flow by signs and pavement markings or raised curbs.

City of San José, California

COUNCIL POLICY

TITLE CRITERIA FOR THE REVIEW OF DRIVE-THROUGH USES	PAGE 1 of 4	POLICY NUMBER 6-10
EFFECTIVE DATE March 13, 1979	REVISED DATE November 6, 1990	
APPROVED BY COUNCIL ACTION		3/13/79; 9/14/79; 11/06/90, Item 8b

BACKGROUND

On March 13, 1979 the City Council approved an amendment to the Zoning Ordinance requiring that all applications for development of establishments with drive-through facilities in the C-1, C-2 and C-3 Commercial Districts be reviewed for adherence to current and applicable criteria and that such development proceed only after issuance of a Conditional Use Permit by the City. On this same date Council approved criteria applicable to such development. Subsequently, on September 4, 1979 the City Council approved additional drive-through criteria for the review of drive-through uses. In 1990, concerns with the development of self-service car wash facilities allowed under PD zoning led to additional criteria.

PURPOSE

To provide guidelines for the development of establishments with drive-through facilities within the City of San José.

POLICY

It is the policy of the City Council that development of establishments with drive-through facilities within the City of San José shall be governed as specified in this policy statement. Approval of such development shall be subject to the following conditions:

1. Development shall be restricted to Commercial Zoning Districts, designated as C-1, C-2, and C-3, and to Planned Development (PD) zoning.
2. Development may not proceed until a Conditional Use Permit or Planned Development Permit is issued by the City.
3. Conditional Use Permits or Planned Development (PD) Permits for establishments with drive-through facilities shall be granted only after applicable criteria adopted by Council have been applied to each application, to the satisfaction of the City's Director of Planning and the City Planning Commission.

Furthermore, it is the policy of the Council that gasoline service stations which do not include car wash facilities as well as vehicle repair and storage facilities shall be exempt from the provisions in this policy statement.

CRITERIA

The following criteria shall be applied to all applications for development of establishments with drive-through facilities which meet the applicable conditional requirements:

I TRAFFIC

- A. Primary ingress and egress to drive-through type use parking lots should be from at least a four-lane major street.

TITLE	CRITERIA FOR THE REVIEW OF DRIVE-THROUGH USES	PAGE	POLICY NUMBER
		2 of 4	6-10

- B. The drive-through stacking lane shall be situated so that any overflow from the stacking lane shall not spill out onto public streets or major aisles of any parking lot. Overflow capacity shall be 50 percent of required stacking for overflow restricted to the parking lot and 100 percent of required stacking if the overflow is directed to the street.
- C. No ingress and egress points shall conflict with turning movements of street intersections.
- D. No drive-through use shall be approved with ingress or egress driveways within 300 feet of a signalized intersection operating at a Level of Service D, E, or F unless a traffic analysis demonstrates, to the satisfaction of the Director of Public Works, that vehicles entering or leaving said use will not impair the efficiency or operation of the intersection.
- E. The drive-through stacking lane shall be separated physically from the user's parking lot and shall have a capacity of:
 1. Financial Institutions—8 cars per lane or 16 total*;
 2. Restaurants—8 cars per lane*;
 3. Photo Uses—2 cars per lane*;
 4. Self-Service Car Washes—5 cars per lane*;
 5. Full-Service Car Washes—15 cars* (may be in multiple lanes);
 6. Other—Capacity requirement to be determined on an individual basis.

*Allow 20 feet per car

The storage required for savings and loans may be less than for banks, and should be reviewed on an individual basis.

Eight (8) vehicles per lane for a drive-through restaurant is a maximum. Certain types of fast-food restaurants may require less storage if substantiated by acceptable data.
- F. No pedestrian crossing of the drive-through lane shall be allowed.
- G. Proposed drive-through uses at or near signalized intersections may compound existing traffic congestion and make it intolerable even if the intersection meets the Transportation LOS Policy. In these situations proposed drive-through uses should be discouraged.

II NOISE

- A. Drive-through speakers shall not be audible from adjacent residentially used, zoned, or General Planned properties.
- B. Drive-through speakers shall not be used when the drive-through lane abuts residentially used, zoned, or General Planned Property.
- C. Use of sound attenuation walls and landscaping shall be encouraged.

III HOURS OF OPERATION

- A. No drive-through portion of land use shall operate after the hour of 10:00 P.M. when adjacent to residentially used, zoned, or General Planned properties.

IV EMISSION CONTROL

It is recognized that auto emissions are particularly objectionable where "tunneling" effects occur due to prevailing wind patterns in combination with building orientation, and where idling vehicles are in close proximity to concentrations of people.

- A. An east-west orientation of drive-through lanes is discouraged, especially on the south side of main buildings.

TITLE	CRITERIA FOR THE REVIEW OF DRIVE-THROUGH USES	PAGE	POLICY NUMBER
		3 of 4	6-10

- B. "Tunneling" will be deemed to occur where adjacent buildings are within thirty (30) feet of each other, or where roof/wall structures enclose a space less than thirty (30) feet. Such situations are discouraged unless air quality analyses performed by the applicant shows that unusual pollutant concentrations will not occur.
- C. Applicants shall take positive steps to protect employees of the drive-through facility from emissions caused by idling cars.
- D. Drive-through lanes shall not be located adjacent to patios and other pedestrian use areas, other than walkways.
- E. Drive-through use stacking lanes are discouraged in close proximity to residential uses, existing or planned.

V URBAN DESIGN

- A. The architecture of drive-through uses shall be compatible and harmonize with that of the shopping center motif or immediate neighborhood in terms of building color, materials, mass, scale, and form. Standardized, "corporate" building designs shall be discouraged.
- B. Drive-through lanes shall be suffered from adjacent properties by means of heavy landscaping, and sound attenuating uses where appropriate and necessary.
- C. Drive-through restaurants shall incorporate seating within the restaurant, and drive-through banking facilities shall provide a walk-up window.

VI LIGHTING

- A. Reference is made to Section 20.12.200 of the Zoning Ordinance.
20.12.200: LIGHTING. Any and all lighting facilities hereafter erected, constructed, or used for or in connection with any off-street parking spaces located in any residential district or adjacent to any residential district shall be so arranged and shielded that light will be reflected away from lands located in such residential district, and so that there will be no glare which will cause unreasonable annoyance to occupants of properties in such residential district, or otherwise interfere with the public health, safety, or welfare.
- B. Lighting devices located on roofs are considered an advertising device and will not be permitted.

In addition, the following specific criteria are recommended.

Recommended maximums for all drive-through uses:

At Residential Property Line	0.1 fc
At Other Property Line	0.5 fc
Detached Signs	50 FL
Attached Signs	20 FL
Parking Lots (drive-up)	0.5 foot-candles at surface
Parking Lots (walk-in)	0.2 foot-candles at surface

fc = Foot Candle = illumination level on work surface.

FL = Foot Lamberts = brightness one sees at the source.

VII LOCATION

- A. Drive-through uses shall be located 200 feet or more from immediately adjacent or directly opposite residentially used, zoned, or General Planned properties.
- B. Drive-through facilities are discouraged in the Downtown Core Area (bounded by Julian Street, Fourth Street, Freeway 280, and Future Freeway 87).

TITLE	CRITERIA FOR THE REVIEW OF DRIVE-THROUGH USES	PAGE	POLICY NUMBER
		4 of 4	6-10

- C. Buildings with drive-through facilities shall be located with a minimum separation of 500 feet from any structure containing a drive-through facility.

Self-service car washes which are proposed in conjunction with existing gasoline service stations may be exempted from this locational criterion, provided the traffic criteria in I above are satisfied.

VIII OTHER CRITERIA

- A. Water drippage on public streets at the exit of car washes shall be minimized through either automatic drying systems or hand drying in connection with full-service car wash facilities or through on-site grading and drainage patterns or other design features in connection with self-serve car wash facilities.

IX DEVELOPMENT REVIEW PROCESS

On and off-site circulation, traffic safety, curbside parking, number or proximity of driveways, speed bumps, and other site development factors shall be considered during the Conditional Use Permit or Planned Development (PD) Rezoning/Permit process and evaluated on a site-by-site basis.

19.475.040 - Site location, operation and development standards.

The standards set forth in Article V, Base Zones and Related Use and Development Provisions, shall apply to drive-thru businesses unless otherwise specified here.

- A. The drive-thru business shall maintain a minimum 100-foot street frontage and be located on an arterial street, as indicated by the Riverside General Plan Figure CCM-4 - Master Plan of Roadways.
- B. When a drive-thru business adjoins any lot in a residential, office or any mixed use zones, a minimum six-foot-high masonry wall shall be erected and maintained along such property line; provided, however, that such wall shall be only three feet high from the setback line of the adjoining property to the front property line.
- C. *Building and landscape setback standards .*
 1. Where a drive aisle or parking is adjacent to a street frontage, a landscape planter with a minimum width of 15 feet in width shall be provided along all street frontages. Where a building is adjacent to a street frontage, the building setback of the base zone shall apply.
 2. A landscape planter with a minimum width of five feet shall be provided along interior property lines, unless the site part of an integrated, master planned commercial complex, where no landscape setback is required along interior property lines.
- D. *Drive-thru lane standards .*
 1. Restaurants shall maintain drive-thru lanes that are a minimum of 180 feet in length to provide on-site storage for a minimum of ten vehicles, as measured from the forward most drive-thru window to the entrance to the queuing space.

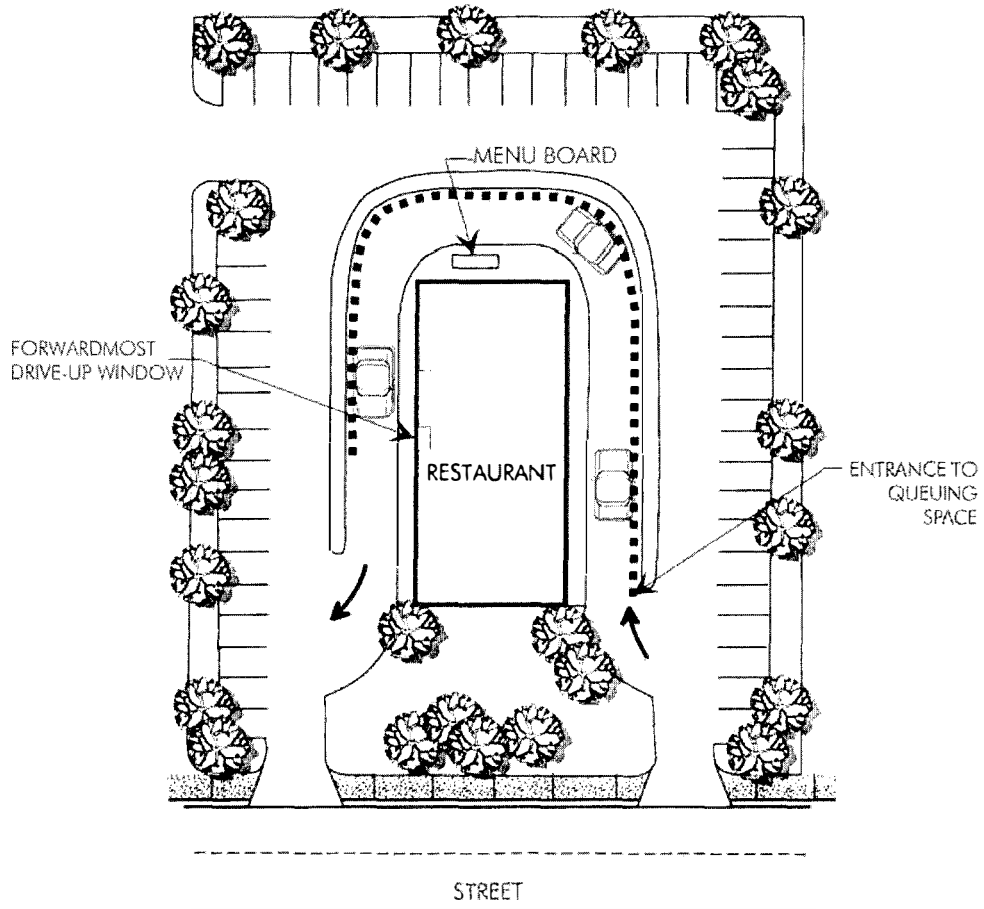

■■■■■■
 MINIMUM
 DISTANCE = 180 FEET

*19.475.040.E.1.
 Drive-thru Lanes*

2. All other uses shall maintain drive-thru lanes that are a minimum of 36 feet in length to provide on-site automobile storage for a minimum of two vehicles.
 3. Each drive-thru lane shall be a minimum of 12 feet in width. The lane shall be independent of any on-site parking, parking maneuvering areas, public streets, alleys or traffic ways.
- E. *Additional requirements for drive-thru lanes associated with restaurants.*
1. Drive-thru windows are discouraged on any building elevation directly facing a street frontage.
 2. Drive-thru lanes shall be designed in such a way as to be screened from view from the street through elevation differences, landscaping, arbors, trellises, canopies, walls and other architectural features used to reduce the visual presence of drive-thru operations.
 3. Freestanding drive thru restaurants should be located on lots with at least 30,000

square feet, except for drive thru restaurants in master planned integrated commercial complexes with shared parking and access.

4. A minimum five-foot-wide landscaped planter should be installed between the drive-thru lane and parking lot maneuvering area when adjacent to one another, as determined necessary on a case-by-case basis.
- F. Additional requirements for a business with drive-thru lane(s) within the MU-U and MU-V Zones.
1. Drive-thru pick-up windows shall not be located on any building elevation facing a street.
 2. Drive-thru lanes shall be located at the rear of the building and screened from view from adjacent streets. For corner properties, a combination of walls and other architectural and landscape features, such as arbors, trellises, canopies, and landscape berms may be used to screen the drive-thru lane from one adjacent street.

(Ord. 7408 §1, 2018; Ord. 7331 §74, 2016; Ord. 7100 §1, 2010; Ord. 6966 §1, 2007)



County of San Diego
Parking Design Manual
Department of Planning & Land Use

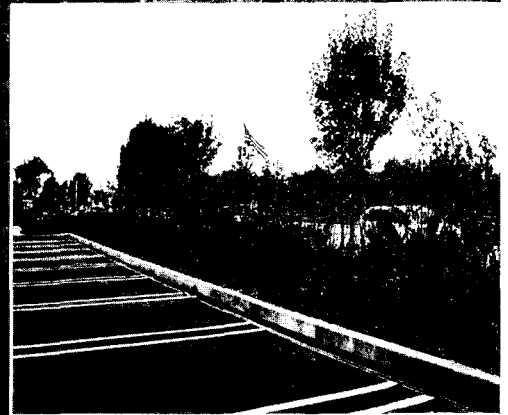
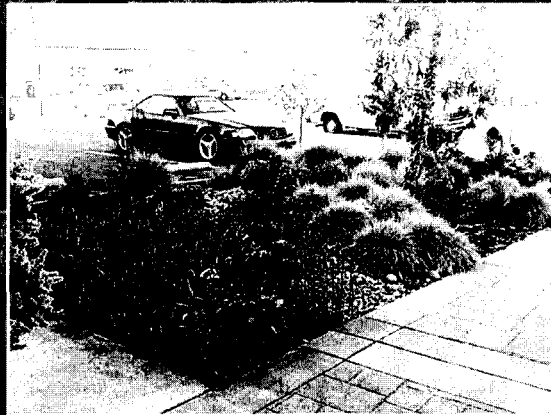

February 2013



- The width of a parking space shall be increased by 2'-0" when adjacent to fences, walls, or planters.
- All driveways and curb openings shall be a minimum of 3' from any obstruction, i.e. poles, hydrants, buildings, walls, and fences.

b. Loading Spaces

Loading spaces shall be a minimum of 10' wide by 35' long per Section 6786 of the Zoning Ordinance.

2. Parking Aisles

a. One-Way and Two-Way Traffic Aisles

Per Section 6792 of the Zoning Ordinance:

- One-way access driveways leading to aisles within a parking area shall be a minimum of 12'.
- Two-way aisles and access driveways leading to aisles within a parking area shall be a minimum of 24'.

Minimum aisle widths for one-way drive aisles within a parking area are shown in Table 2.

b. Fire Access Aisles

Designated fire access aisles must comply with the County's Consolidated Fire Code and/or the Fire Authority Having Jurisdiction. Minimum unobstructed fire access width is 24'. Inside turning radius minimum is 28'. Vertical clearance minimum is 13'-6". The Fire Authority Having Jurisdiction may require greater dimensions. For more information regarding Fire Code standards, contact the San Diego County Fire Authority.

c. Truck Aisles

Access aisles for multiple-axle trucks in commercial and industrial projects shall be a minimum width of 40' for projects with a gross floor area of 10,000 square feet or greater or where the design of the project includes a loading dock, per Section 6792 of the Zoning Ordinance. Truck movement templates (i.e. turning radii elements including wheel paths, which define the needed width of pavement edge that must be clear from obstructions above curb height) shall be included on the site plan to indicate turning conditions per Section 6792 of the Zoning Ordinance.



**Table 3
Minimum Parking Layout Dimensions**

Figure 3 Label	Design Component	Parking Angle				
		0° (Parallel)	30°	45°	60°	90°
A	Stall Width	9'(8') ¹	9'	9'	9'	9'
B	Stall Length	22'	18'	18'	18'	18'
C	Stall Width Parallel to Aisle	N/A	18'-0"	12'-9"	10'-5"	9'-0"
D	Stall Depth to Curb or Wall	N/A	16'-10"	19'-1"	20'-1"	18'-0"
E	Stall Depth to Interlock	N/A	12'-11"	15'-11"	17'-10"	18'-0"
F	Aisle Width ² One-Way	13'	14'	16'	19'	N/A
	Two-Way	24'	22'	24'	24'	26'
G	Module Width One-Way Aisle	N/A	43'-9"	51'-0"	46'-11"	N/A
	Wall/Curb to Interlock Two-Way Aisle	N/A	51'-9"	59'-0"	61'-11"	62'-0"
H	Module Width One-Way Aisle	N/A	39'-10"	47'-10"	54'-8"	N/A
	Interlock to Interlock Two-Way Aisle	N/A	47'-10"	55'-10"	59'-8"	62'-0"
not shown in Figure 3	Module Width One-Way Aisle	31'-0"	47'-8"	54'-2"	59'-2"	N/A
	Wall/Curb to Wall/Curb Two-Way Aisle	42'-0"	55'-8"	62'-2"	64'-2"	62'-0"
I	Cross Aisle One-Way	15'	15'	15'	15'	15'
	Width ² Two-Way	22'	22'	22'	22'	22'

¹ 8' width applies to on-street parking stalls

² The Director may require greater aisle width due to emergency San Diego County Fire Authority equipment access needs. Aisles less than 24' shall not be designated as Fire Access.

N/A – Not Applicable

**Figure 3
Reference Drawing for Minimum Parking Dimensions**

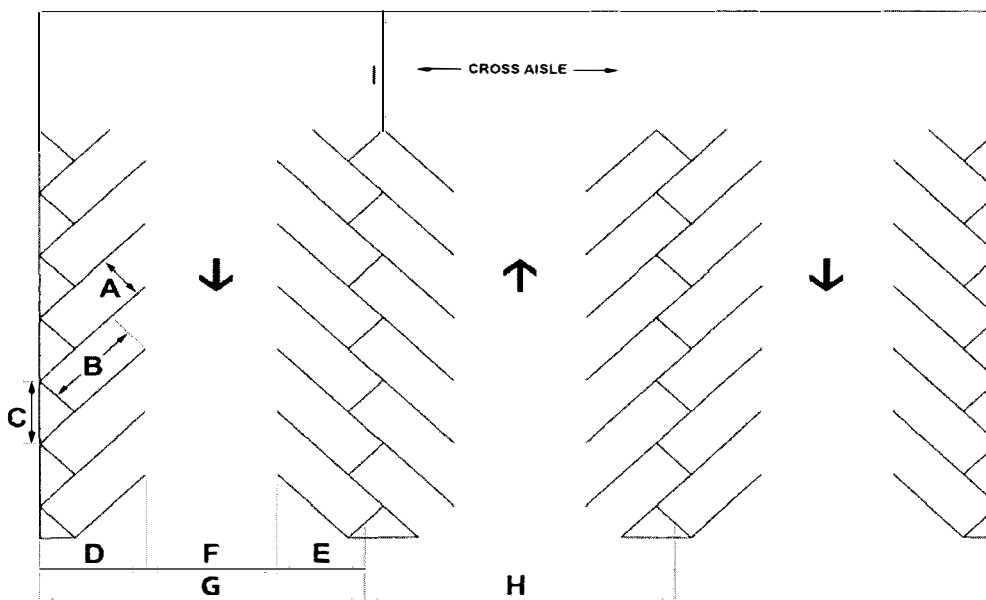
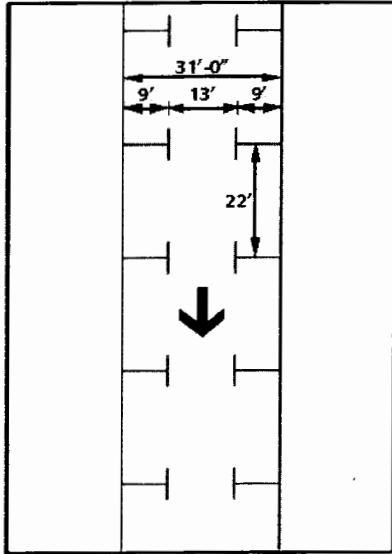
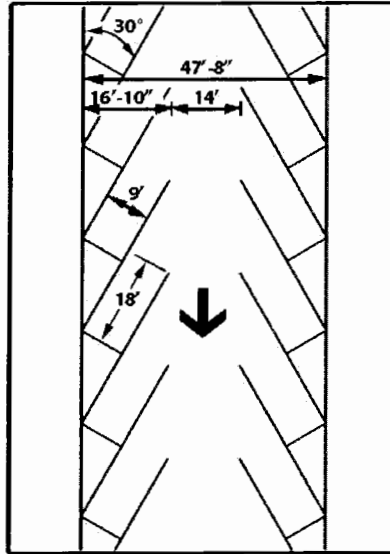



Figure 4
Minimum Dimensions for Common Parking Lot Layouts



0° Parallel Parking Spaces



30° Parking Spaces

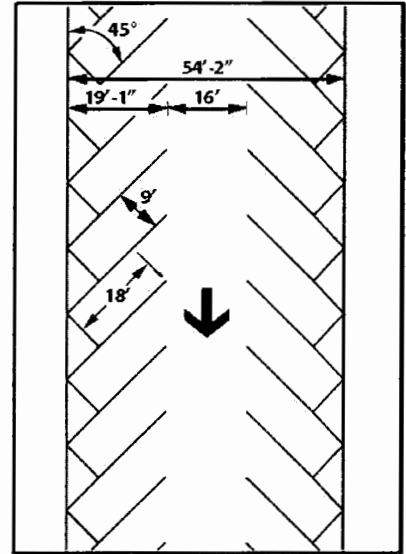

45° Parking Spaces

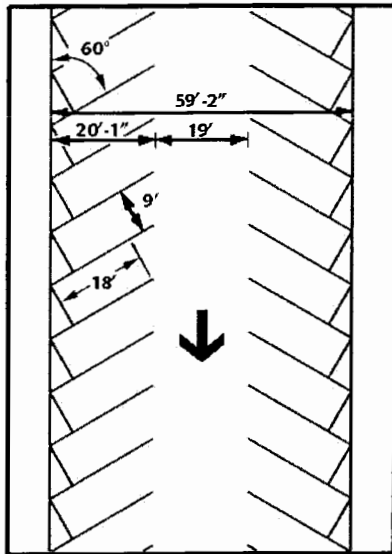

**60° Parking Spaces
One - Way**

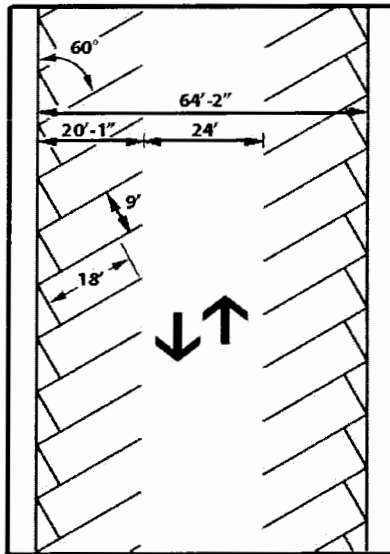

**60° Parking Spaces
Two - Way**

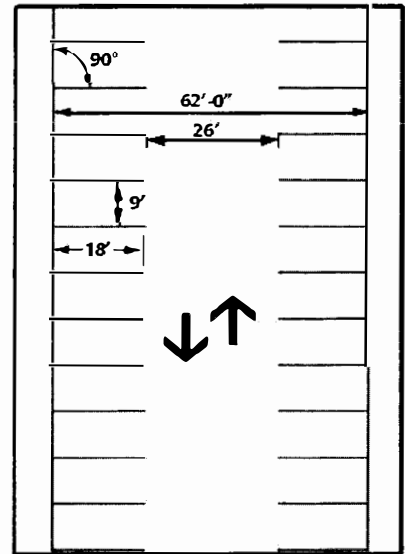

90° Parking Spaces



Figure 5 Example of Parking Lot Angles and Dimensions

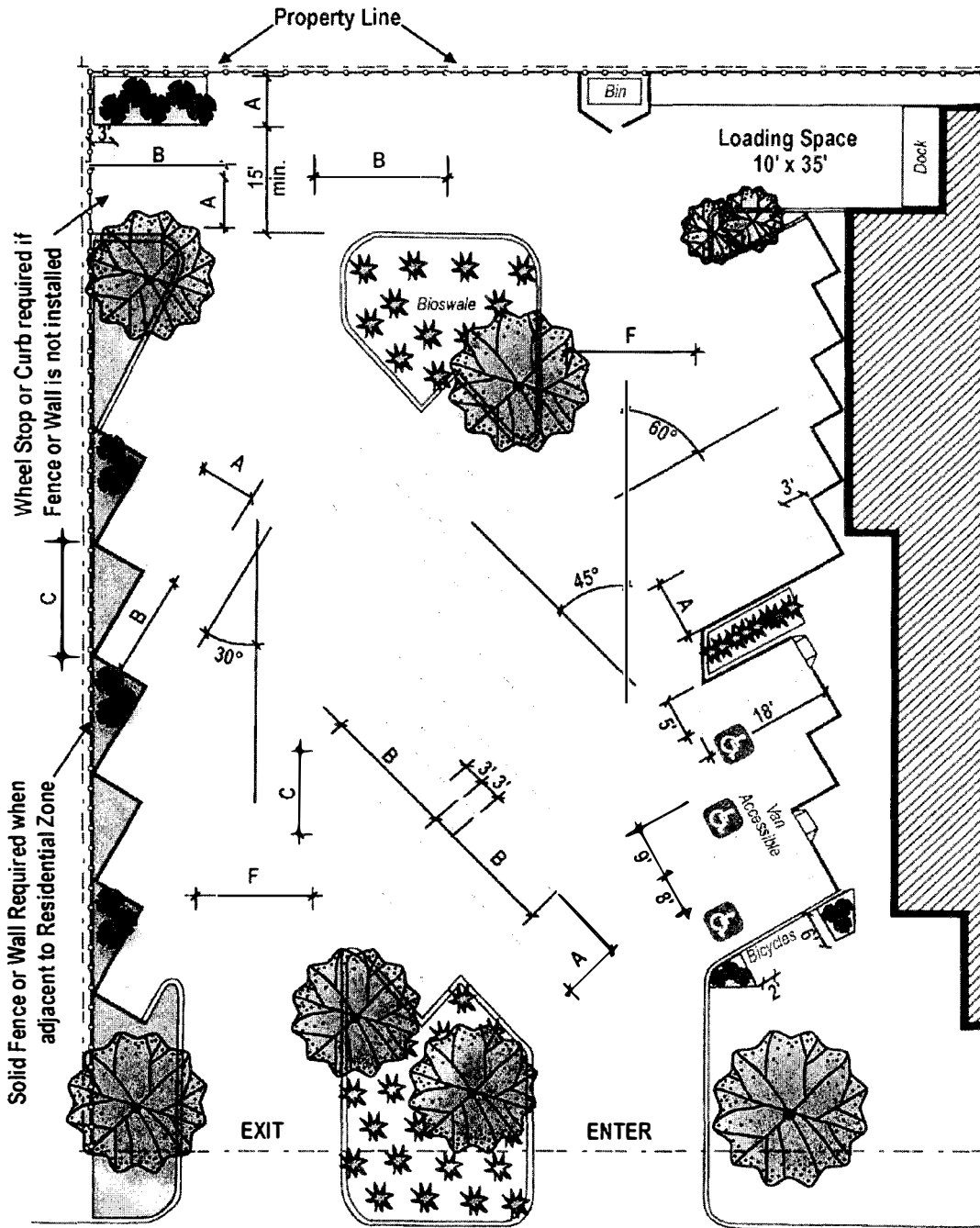



d. Drive-Through Aisles

All projects which feature drive-through facilities (bank, pharmacy, fast-food, etc.) shall provide a drive-through aisle capable of a reasonable queuing of vehicles without impeding the circulation of traffic within the parking area or abutting driveway or street travel way. Drive-through aisles should not cross pedestrian pathways and be clearly designated with striping and/or signage. See the Zoning Ordinance for specifications.

3. Access Driveways

The construction, repair, and maintenance of all driveways, curbs and gutters, and sidewalks are the responsibility of the property owner, developer, or tenant. The responsibility includes the entire area of driveway from the edge of the existing pavement of traveled way to the property line and all culverts or other structures necessary for property drainage control.

A residential driveway is any driveway serving property used solely as a private single, duplex, or triplex residential dwelling unit, including farms or ranches not used as retail outlets. All other driveways are considered commercial driveways. For specifications on residential driveways, see Section III D.

All residential and commercial driveways designated as a fire access road shall comply with the County's Consolidated Fire Code.

To minimize interference with the flow of traffic and provide optimum access, driveway design should also consider:

- line of sight,
- offset to adjacent and opposing driveways, and
- proximity to nearby intersections.

Parking facilities should be designed to minimize the number of driveways to private property from streets and highways.

Not more than 40% of property frontage on residential lots and 60% of property frontage on non-residential or multi-family residential lots may be allocated for driveway curb openings, except for lots with frontage of 50' or less, which are entitled to one 16' driveway with a 22' curb opening.

Refer to the County of San Diego Public Road Standards and Standards for Private Roads for additional information.

4. Slope / Grade

a. Driveway Slope/Grade

Commercial and multi-family residential driveways serving parking lots with 5 or more spaces should not exceed 15 percent grade. The Fire Authority Having Jurisdiction may allow driveway grades up to 20 percent with mitigation. Crown or cross-slopes of driveways shall be 2 percent except the minimum cross-slope



EDC COB <edc.cob@edcgov.us>

Hearing on Drive Thru in Saratoga Way (on October 9th)

1 message

ashok bennet <ashoktwinkle@hotmail.com>
To: "edc.cob@edcgov.us" <edc.cob@edcgov.us>

Fri, Oct 5, 2018 at 7:43 PM

Hi,

We Ashok Bennet and Twinkle Ashok are owners and resident of 521 Finders Way, El Dorado Hills, CA 95762.

This email is regarding the Hearing of a Drive Thru on Saratoga Way which is to be held on October 9th at 1:00 PM.

Unfortunately we will not be able to attend the hearing due to work.

We **strongly oppose any drive thru in Saratoga Way** in front of residential zone. **(Strong NO)**

The Saratoga way is used by residents and William Brooks elementary School as of now. There is also new home coming up in Saratoga way which will increase the traffic in Saratoga Way. Saratoga way has only on line each direction and already is a pain get in and out of El Droado Hills Blvd.

We have lot of young children since it is near elementary school. I feel strongly for the security of these kids (traffic accidents and other).

Adding a drive thru will increase the the traffic and congestion and will also increase Noise and Pollution.

The entry from El Dorado Hills Blvd will get congested due to the current design of the road.

So please honor the county laws that has been established and should be denied at all cost.

Thank you,

Ashok Bennet
Twinkle Ashok
521 Finders Way
El Dorado Hills, CA 95762



EDC COB <edc.cob@edcgov.us>

Saratoga Building Permit Change

1 message

Ryan Davey <rtdavay@yahoo.com>

Sat, Oct 6, 2018 at 10:52 PM

To: edc.cob@edcgov.us

To Whom It May Concern

In regard to a drive-thru restaurant on Saratoga, you are required, as public servants, to adhere to the original building permit. The original plans can not legally be amended so the entire process of submitting approval by the land developer for commercial use must start again from the beginning. This includes all traffic studies and impact on infrastructure assessments. All of this must be redone regardless of your recent reassessment, which was grossly inaccurate.

The current status of the EDH Blvd underpass is highly inadequate during high volume traffic flow. Consider the state of this location after homes and retail are occupied. It's not going to be good.

It's also worth considering that highway drive-thru locations with high visibility are highly attractive to vagrants. Whether you realize it or not, this clientele will be included with the local residents in frequenting this location. Do you want to be responsible for bringing that component into this town?

As public servants of EDH and El Dorado county, ask yourselves what is your goal for this community? What will be your legacy? If either of these answers is financially based, then clearly my appeal will fall on deaf ears. I hope this is not the case.

Do the right thing, stick to the original plans, don't let EDH become another Roseville or Elk Grove. Thank you.

Sincerely,

Ryan Davey



EDC COB <edc.cob@edcgov.us>

Board Hearing regarding Drive Thru on Saratoga Way- October 9th

1 message

Tim Halverson <timhalv@yahoo.com>

Sun, Oct 7, 2018 at 9:41 AM

To: "edc.cob@edcgov.us" <edc.cob@edcgov.us>

I wanted to let you know that I am for the approval of the Drive Thru restaurant at Saratoga Way. I used to be a resident in the Crescent Ridge subdivision, and knew that when we moved in there was commercial development slated throughout Saratoga Way, along with a pathway to Folsom. It was always assumed that Saratoga way would be extremely busy. I it disheartening that people move into an area, with vacant land around it, but either dont bother to find out what is zoned or slated to go in that vacant space, or just ignore it, then will fight whatever it is that someone tries to put in that could benefit the whole community.

We moved out of the Crescent Ridge subdivision, not because of what we thought was going to go in, but because we found another home that fit our families growth. We were actually looking forward to the services and the access to Folsom. I believe that the people opposing this Drive Thru are grasping at whatever straws they can to stop this from going in. I for one, am for this project, and really disappointed in the Nimby mentality of our citizens, although I'm not surprised, unfortunately. There is a small group, however, they are extremely vocal, that actually makes their voices seem much larger than they really are.

I've been involved in El Dorado Hills in many facets since 1991, including being on the EDH Incorporation task force back in the day, EDH Community Council, EDH DRC, etc., and I want what's best for the community, not just for what is in my specific best interest. I implore the BOS to allow this project to go through, and stop the vocal few from disallowing this project to benefit the community as a whole, and still follow the intent of the zoning for this area. What better spot is there for this type of business? If you can't put in a drive thru, in a busy intersection with 2 gas stations, etc. then we are really not thinking about responsible commercial development. This is exactly what this area was designed for.

Thank you for considering my position on this important subject. I couldn't sit on the sidelines any longer, and not say anything. The position to this project has really reached an all time low.

Sincerely,

Tim Halverson
5001 Winterfield Dr.
El Dorado Hills, CA 95762
cell: 916-812-1500



EDC COB <edc.cob@edcgov.us>

Re: RV / TRUCK Turning Radius FLAWS in DR-R 18-0001 Saratoga Retail

1 message

Kim S - Camom <CAmom2345@hotmail.com>

Sun, Oct 7, 2018 at 1:41 PM

To: "bosone@edcgov.us" <bosone@edcgov.us>, "bostwo@edcgov.us" <bostwo@edcgov.us>, "bostthree@edcgov.us" <bostthree@edcgov.us>, "bosfour@edcgov.us" <bosfour@edcgov.us>, "edc.cob@edcgov.us" <edc.cob@edcgov.us>
 Cc: Brooke Washburn - neighbor <washburn_bew@yahoo.com>, Rebecca - neighbor <rebecca.isbell@ymail.com>, Hilary Krogh - Saratoga <hilaryd73@gmail.com>, "rafael.martinez@edcgov.us" <rafael.martinez@edcgov.us>, "tjwhitejd@gmail.com" <tjwhitejd@gmail.com>, "jdavey@daveygroup.net" <jdavey@daveygroup.net>, "john.hidahl@edcgov.us" <john.hidahl@edcgov.us>, "shiva.frentzen@edcgov.us" <shiva.frentzen@edcgov.us>, "brian.veerkamp@edcgov.us" <brian.veerkamp@edcgov.us>, "michael.ranalli@edcgov.us" <michael.ranalli@edcgov.us>, "sue.novasel@edcgov.us" <sue.novasel@edcgov.us>, "jjrazzpub@sbcglobal.net" <jjrazzpub@sbcglobal.net>, charlet burcin <charlet331@gmail.com>, Karen Sloan - neighbor <ksloan99@hotmail.com>

Please add this comment and attachments to the public file for Dr-R 18-0001 Saratoga Retail for the upcoming October 9, 2018 El Dorado County Appeal Hearing.

Planning Commissioners et al.

The current proposal for the parking configuration to accommodate large delivery trucks, RV's and trucks with trailers would have you believe it is perfectly feasible to accomplish such a parking task by large vehicles (with potentially inexperienced drivers).

Scrutinizing the Helix design "Site Plan, Figure 3" (attached) the project allows for 24' widths between rows of cars, landscaping etc on the design. There is a gutter behind the row of cars adjacent to Bldg 3 that appears to add two feet, so in that area it can be assumed the pavement measurement for a right turn is **26' - 28'**. Add a few more feet from the pedestrian walkway in the middle and it is still not enough feet for large vehicles, especially ones with trailers to navigate these turns.

Attached are many diagrams showing the turning radius of large vehicles. At a BARE minimum the radius needs to be 40'. Many of the diagrams show between 50'-80' for a 90 degree turn depending on the size / length of the vehicle and whether it involves a trailer.

The RV / Truck loading parking approach from Walgreens can happen in one of two ways, a near 90 degree right turn (into oncoming exiting vehicles from the proposed drive thru) and a sort of S turn adjacent to Building 2A next to the pedestrian walkway. This S turn begins with a 90 degree right turn and immediately ends with an approximate 45 degree left turn. Consider the feasibility of "snaking" large vehicles in this fashion, especially RV owners who may not be adept at turning.

The other possible entry is the second driveway where loading trucks, RVs, and trucks with trailers can enter, this turning radius is more broad, appears to be 56 degrees, yet if the other spots are inhabited the performance of turning into the spot is limited to the width of the actual spot accommodating only 10' radius for the turn into the space and no more.

Basically, the configuration that the developer has supplied is misleading. They are "plugging in" RV spots in a location that is apparently unfeasible in the real world to actually turn something to get in the parking spots. Let alone open doors and actually get out of the vehicles.

The apparent only way is in to pull up via the second driveway and then back-out. Even in this scenario the backing out has its own turning radius issues, especially in light of the cars that will be backed up and stacking up in front of the parking spaces idling and waiting their turn near the RV / Truck loading spots. At over 100 vehicles per hour and shown by photos (see attached) Chik Fil WILL HAVE VEHICLES STACKING INTO THE PARKING LOT.

Please take a careful look at the diagrams and try to understand how the configuration for loading and RV and trucks with trailers will work in a real life scenario, especially with inexperienced RV drivers.

What will happen is that people will park their RV's on Saratoga Way and then leave the road by taking Arrowhead to Mammoth and turn left onto Saratoga. But when Mammoth becomes a right turn only, the vehicles will be forced to loop back the same way they came and either continue on Saratoga to Iron Point (once it is connected) or, if they are heading east toward Tahoe, drivers will again take a right turn onto Arrowhead (if the turning radius allows if there are no cars parked on the street) and then drive up into a residential neighborhood to and figure out how to get out. When Saratoga becomes a four lane with a raised median, the scenario for Park Village Residents becomes even worse. We will have multiple transient RV's parking right in front of our homes!!! Imagine people pulling out lawn chairs and eating chicken burgers in front your house.

Please approve of the Appeal to deny the new DR R-18-0001 Saratoga project as it is a Fast Food drive through that attracts RV's and trucks with trailers and has weekly large truck deliveries. Having a fast food drive thru next to a residential neighborhood is not conducive to the goals of the County of El Dorado General Plan in that it appears to give advantage to the developer over the needs of the community and the adjacent residential neighborhood.

Thank you for your time and consideration,

Kim Shultz



Turning Radius.zip
3418K

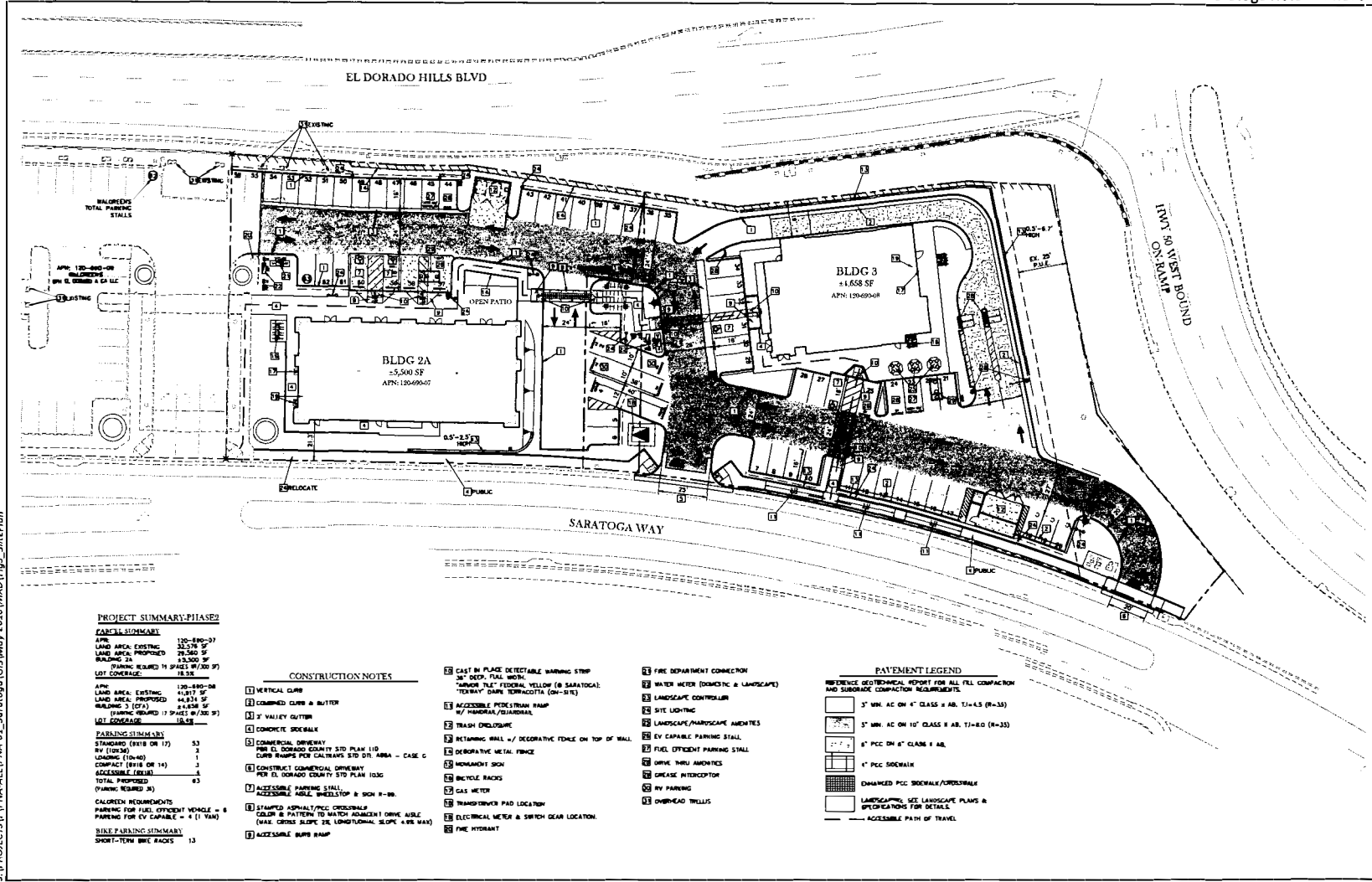

S:\PROJECT\IPMA-ALL\IPMA-07_Saratoga\GIS\Map 2018\WKD\Fig_3_SitePlan

Source: TSD Engineering, Inc. 2018

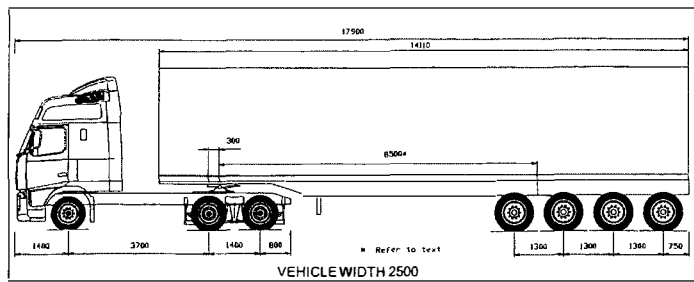

DESIGN VEHICLE DIMENSIONS (mm)

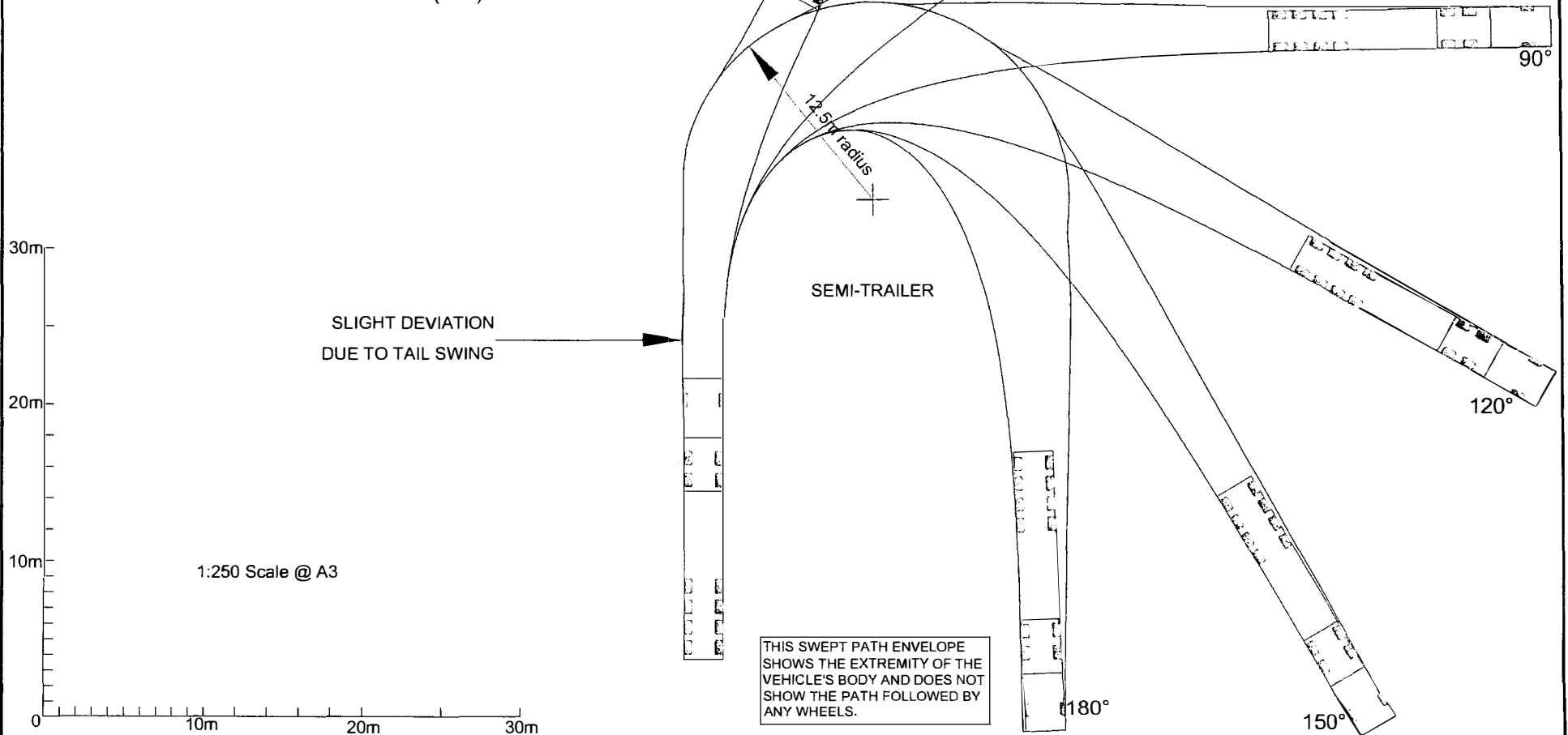
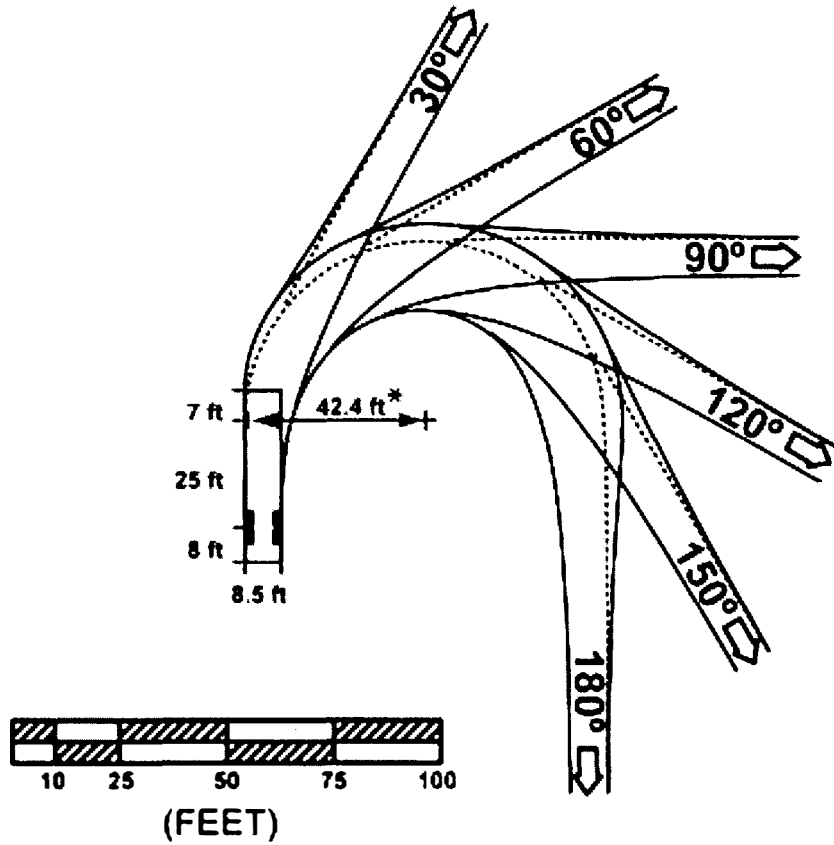
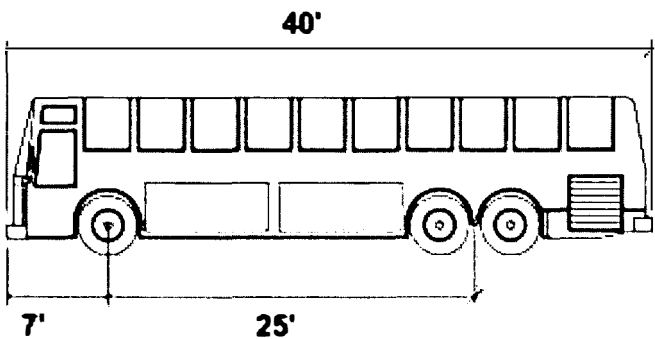

Figure 404.5E
40-Foot Bus Design Vehicle



* Radius to outside wheel at beginning of curve.



LEGEND

	Swept Width (Body)
	Tracking Width (Tires)

40' BUS

- Width : 8.5'
- Track : 8.5'
- Lock to Lock Time : 6 seconds
- Steering Lock Angle: 41.0 degrees

Note: For definitions, see Indexes 404.1 and 404.5.

WB-62 [WB-19] DESIGN VEHICLE
RADIUS = 75 ft [22.9 m]
SCALE = 1:20 [1:200]

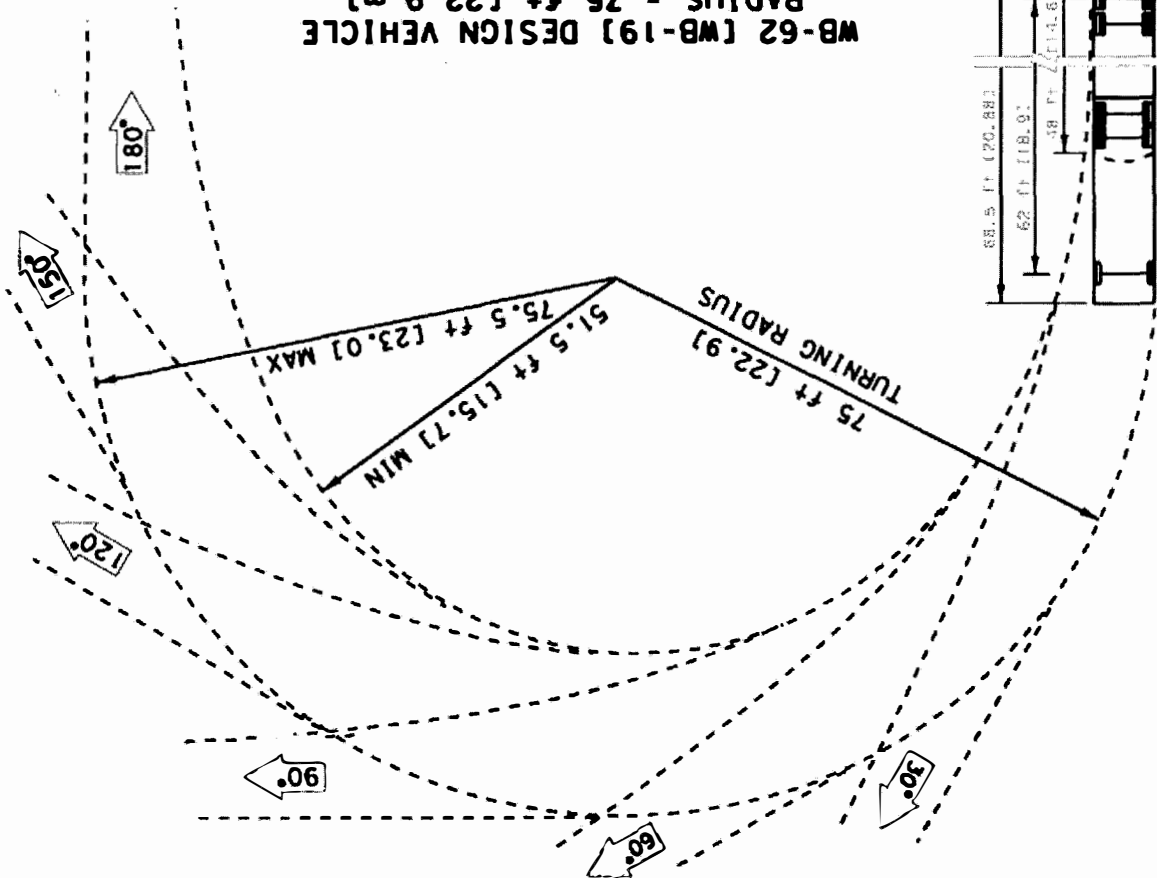
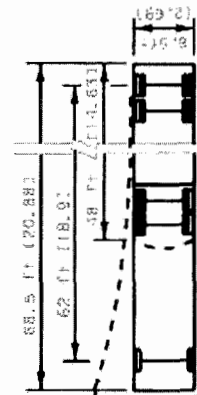

Turning Template for Semi-Trailer with
62 ft [18.9 m] Wheelbase (Radius=75 ft [22.9 m])

WB-40 [WB-12] DESIGN VEHICLE
RADIUS = 40 ft [12.20 m]
SCALE = 1:20 [1:200]

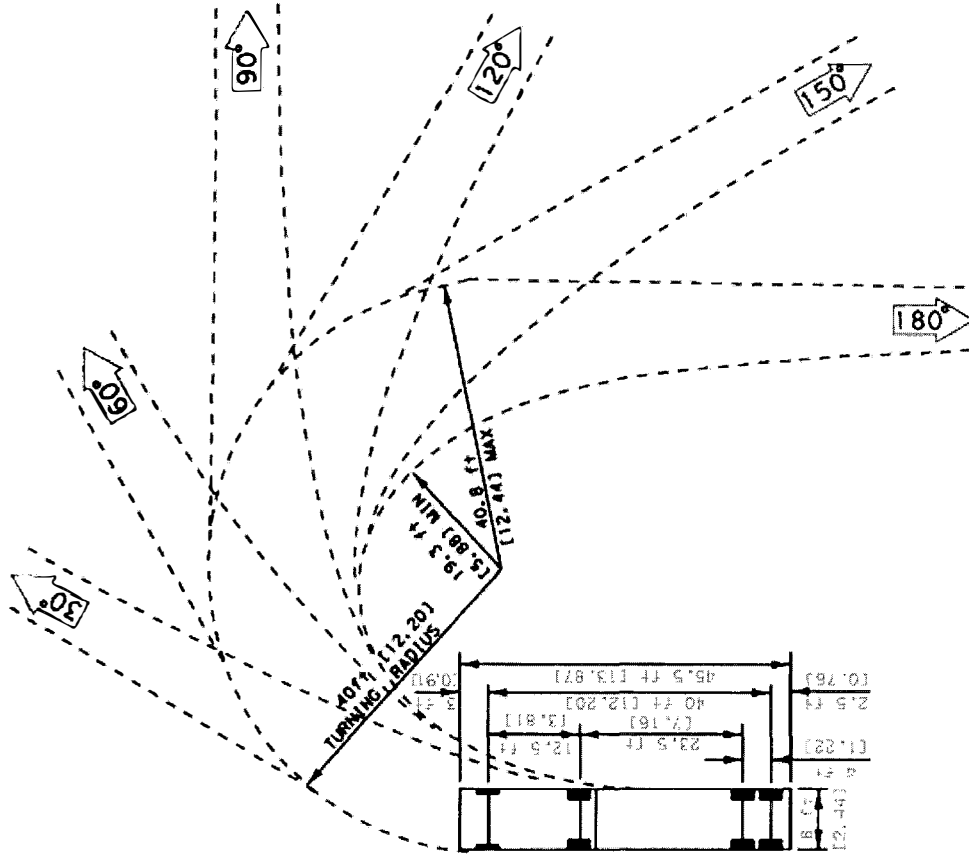

Turning Template for Semi-Trailer with 40 ft [12.20 m] Wheelbase

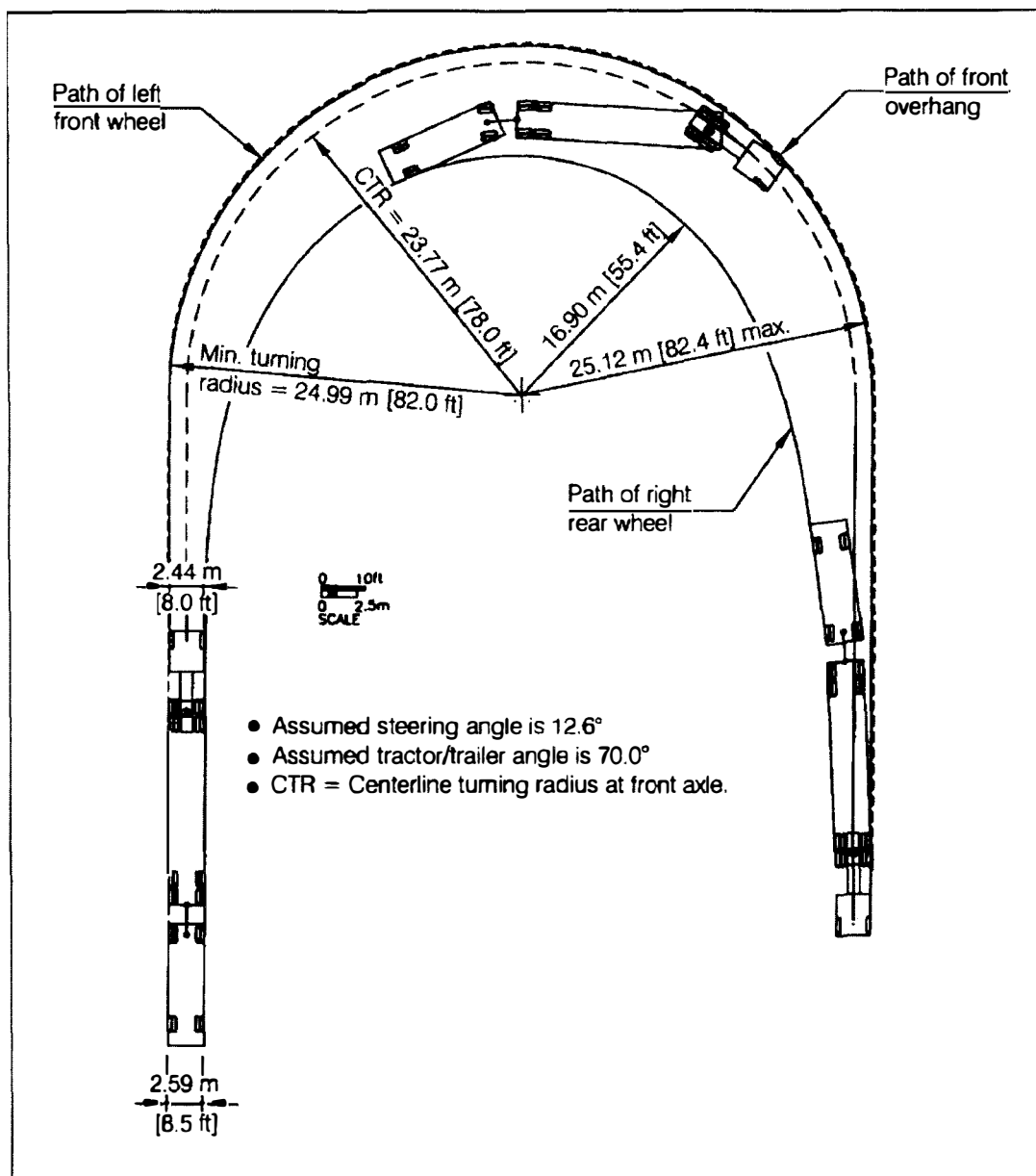
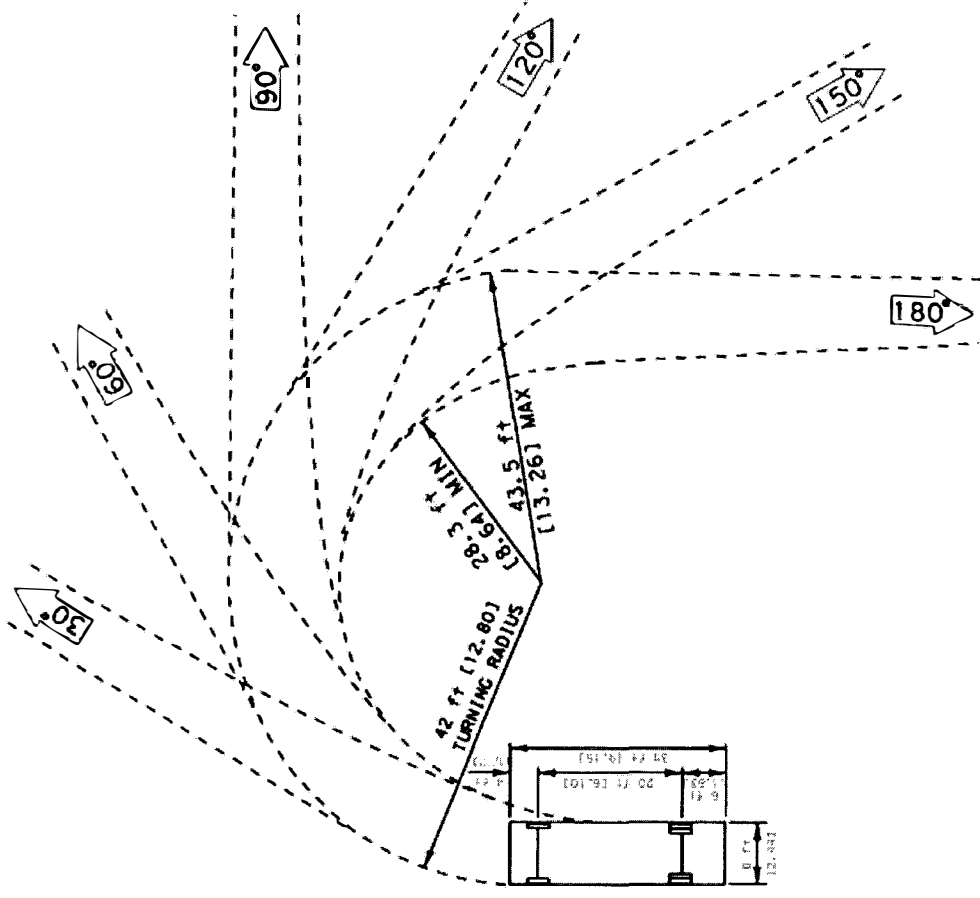

Figure C-20. Minimum 180° turn: WB-28D [WB-92D] double trailer combination.

by bringing the AutoTURN plot into AutoCAD and scaling the appropriate distances. The largest radial distance between the two paths (that of the center of the front axle and that of the inside rear axle set) was scaled. Measurements were taken along the entire length of the curve until a maximum radial distance was determined. In Figure C-22, several of the actual measurements are displayed with the maximum distance shown with a box around it. Since offtracking is measured to the centerline of both the front and rear axle set, half the width of the rear axle set was subtracted from the measured

radial distance to provide an estimate of the maximum offtracking. For example, the tractor-semitrailers and the double trailer combinations had 2.6 m [8.5 ft] wide trailers. Therefore, 1.3 m [4.25 ft] was subtracted from the measured radial distance to determine the maximum offtracking of these vehicle types, while 1.2 m [4.0 ft] was subtracted for the single unit trucks. Thus, for the given example of the proposed WB-23D [WB-77D] design vehicle negotiating a 90-degree turn with a 15.2 m [50 ft] radius, the maximum offtracking is 4.3 m [14.2 ft].

SINGLE UNIT (SU) TRUCK DESIGN VEHICLE
TURNING RADIUS = 42 ft [12.80 m]
SCALE = 1:20 [1:200]



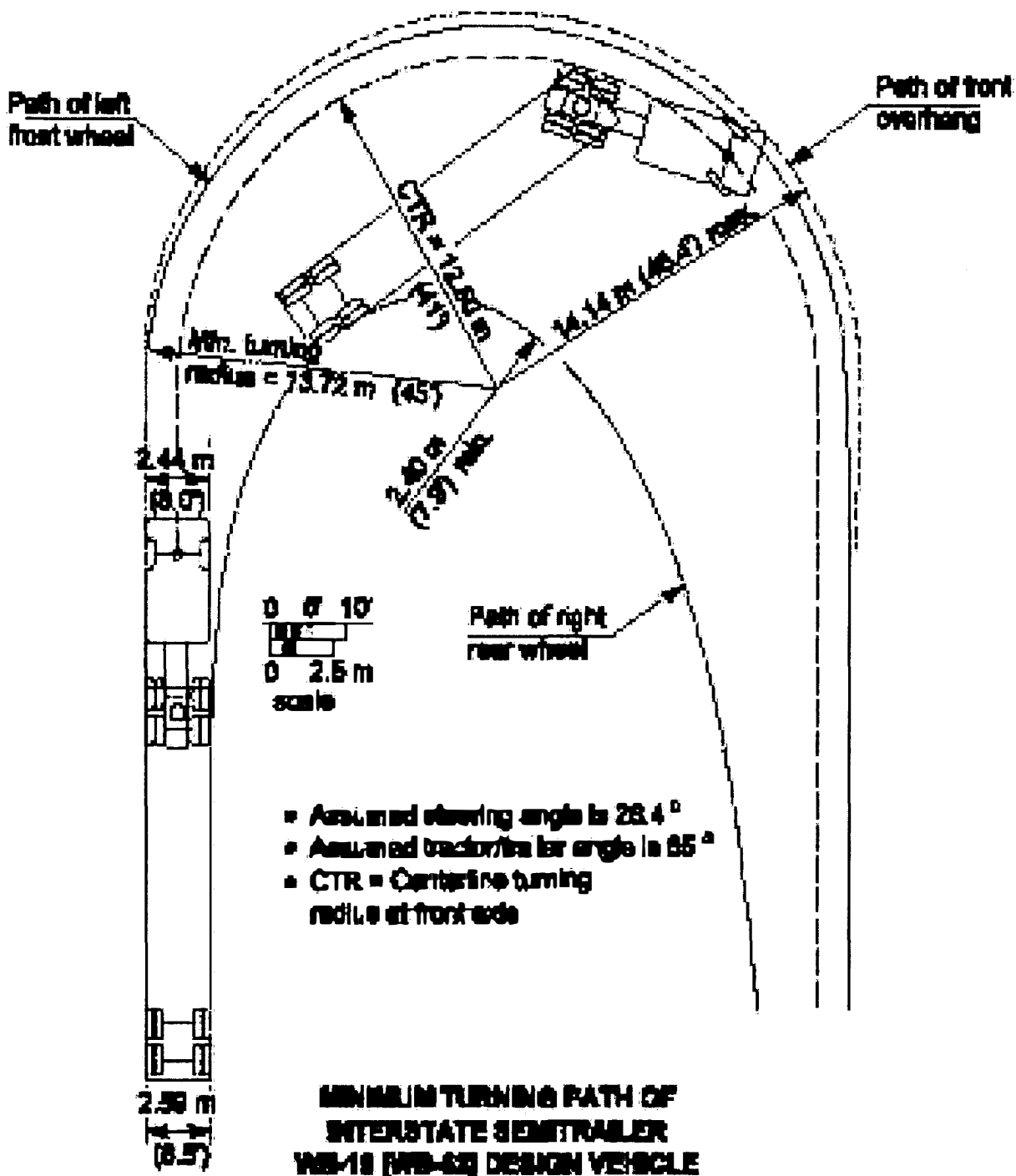
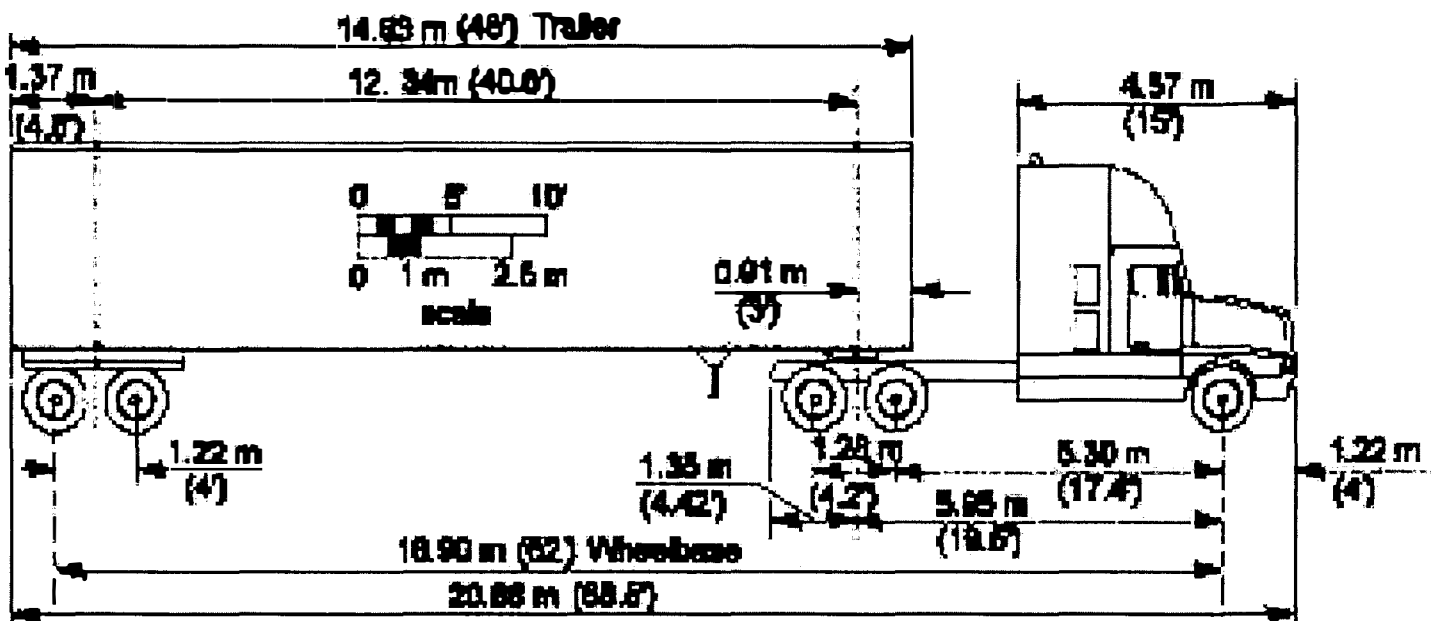

Turning Template for Single Unit Trucks or Buses

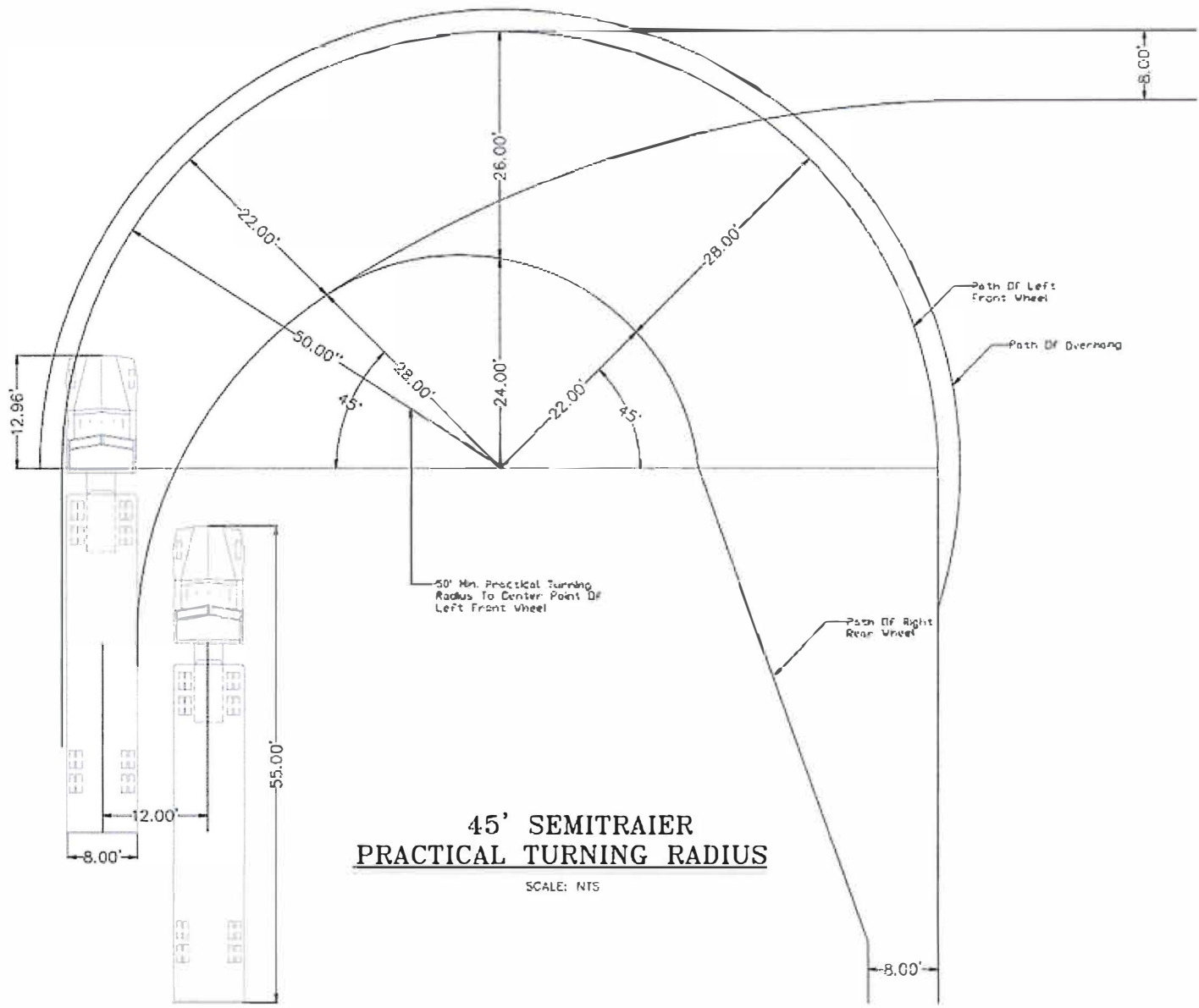



**45' SEMITRAIER
PRACTICAL TURNING RADIUS**

SCALE: NTS

UNIVERSITY OF TEXAS AT EL PASO	
	
SOLSTICE GROUP	
Abel Borunda Alan Lara Cruz Alvarez Miguel Angel Gonzalez Osvaldo Broesicke Sammy Romero Taina Padilla	
PROJECT DESCRIPTION	
SOLAR PANEL CANOPY AT PHYSICAL PLANT PARKING LOT UNIVERSITY OF TEXAS AT EL PASO CITY OF EL PASO, TEXAS	
	
SCALE	SHEET NUMBER
NTS	4 OF 4
PLOT DATE	
11/17/11	
FILE NAME	
TURNING_RADIUS	

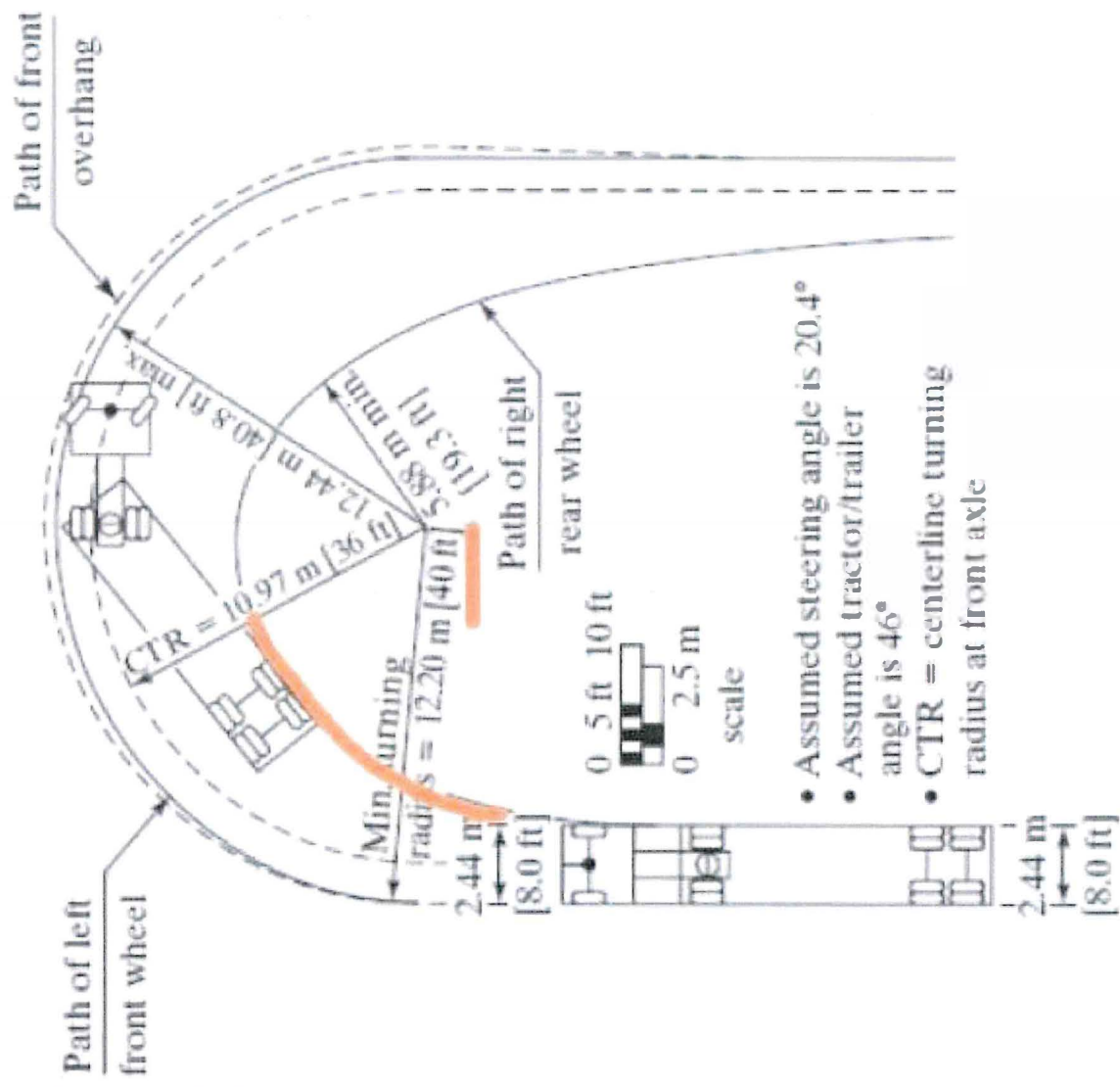
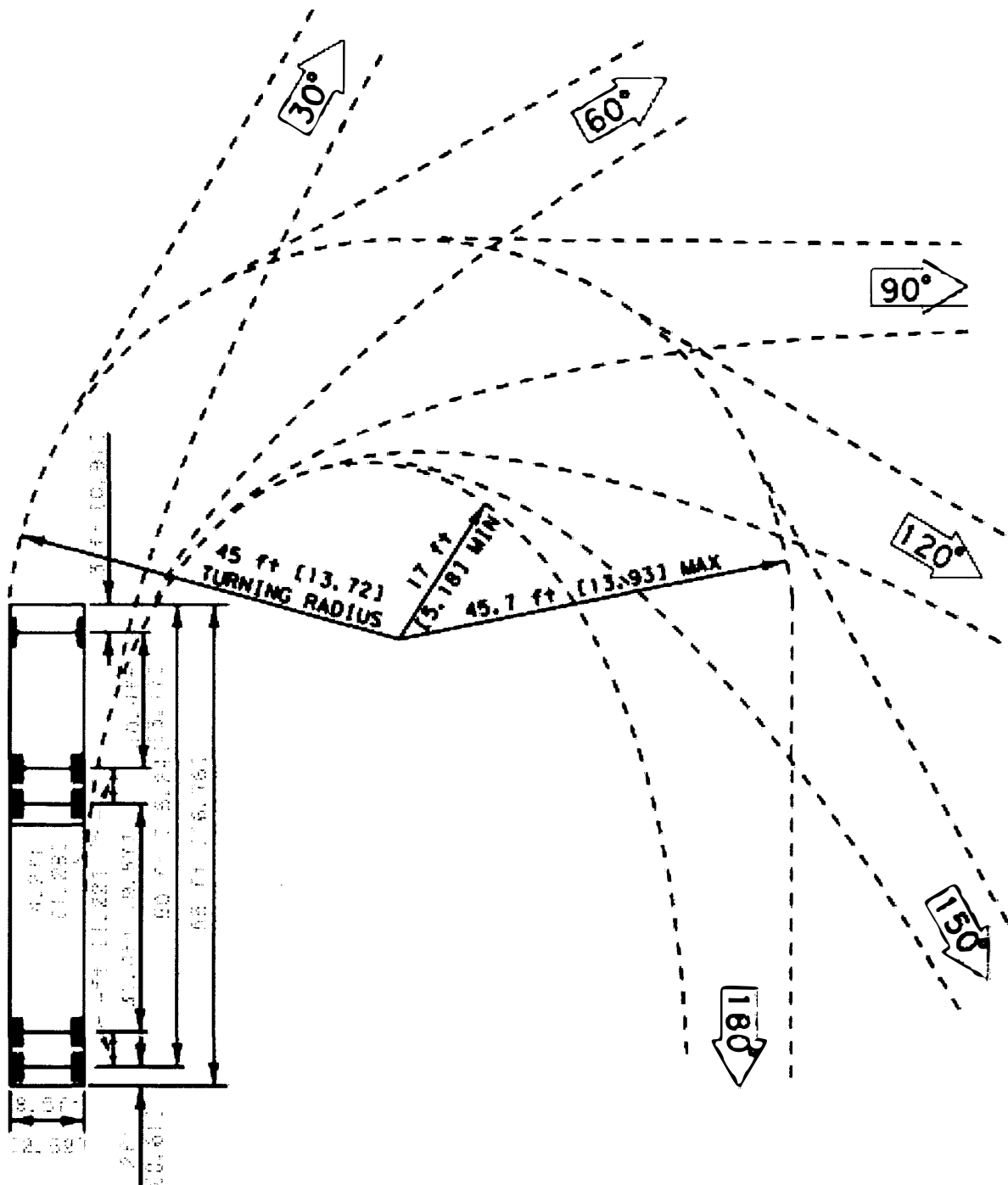

Figure 2.4: Low-Speed Turning Template for WB-40 Combination Vehicles

**WB-50 [WB-15] DESIGN VEHICLE
 RADIUS = 45 ft [13.72 m]
 SCALE = 1:20 [1:200]**



Turning Template for Semi-Trailer with 50 ft [15.24 m] Wheelbase

Turning Characteristics

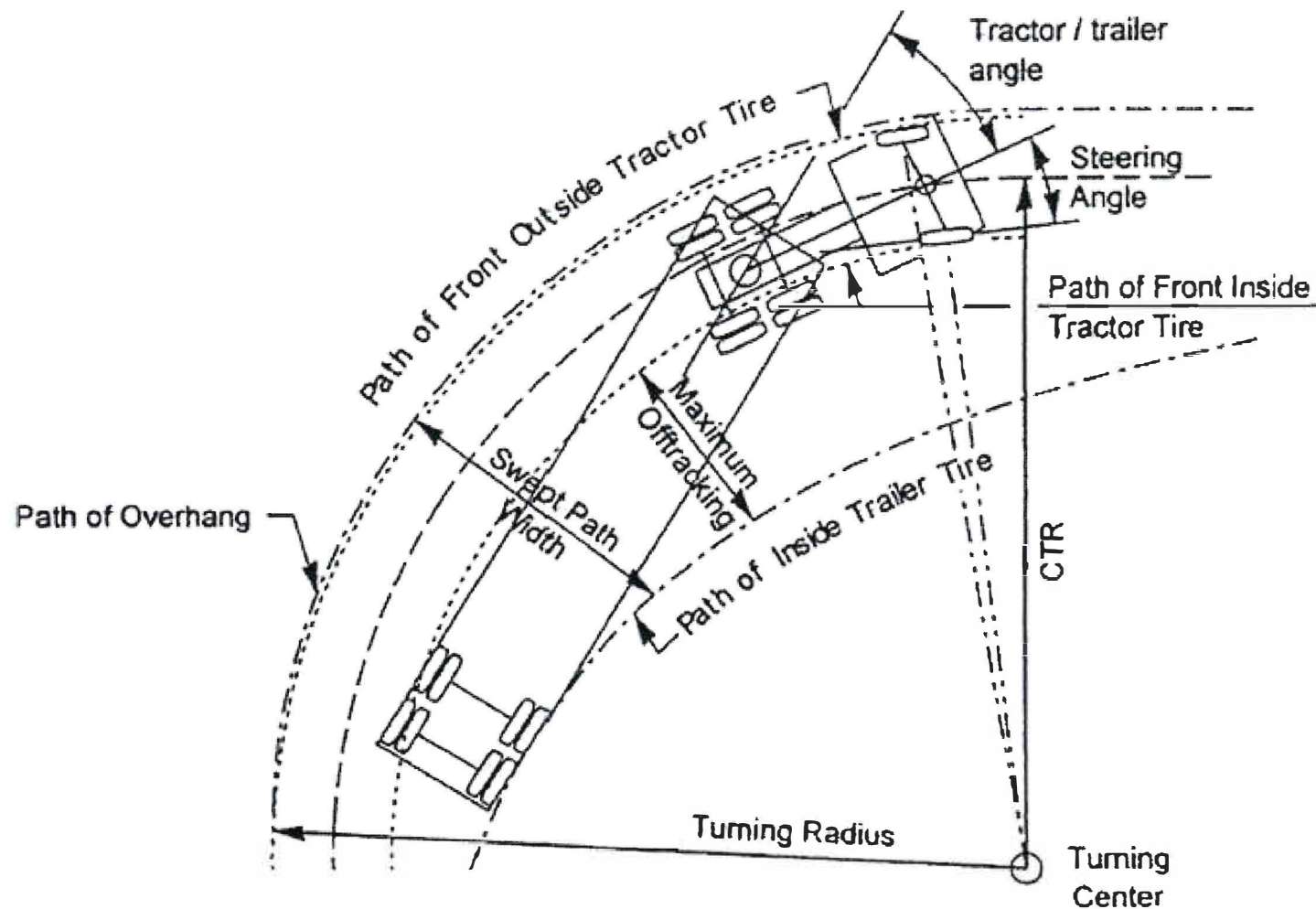

Understanding Motorhome Turning Radius vs Wheel Cut

Posted on December 3, 2011

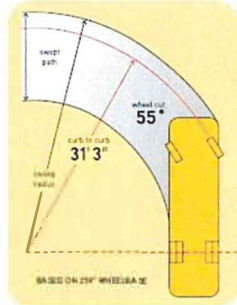

Example: Motorhome's Turning Radius with 55 Degree Wheel Cut and 259" Wheelbase

Turning Radius: The turning radius or turning circle of a motorhome is the size of the smallest circular turn (i.e. U-turn) that the RV is capable of making.

Wheel Cut: Wheel cut is how sharply the front wheels can turn, measured in degrees.

Wheelbase: The wheelbase is the horizontal distance between the center of the front wheels and the center of the rear wheels.

Benefit of Increased Wheel Cut: Gives your motorhome better maneuverability in tight spaces such as campgrounds, parking lots, and fuel stations by decreasing its turning radius. The turning radius is effected by the coaches wheelbase and the degree of its wheel cut.



Diesel Motorhome Chassis: The Wheel Cut & Wheel Base Effect On Turning Radius



Motorhome Chassis Example: Freightliner XC-5

Links:

Check Out Thor Motor Coach's New Motorhomes>> (<http://thormotorcoach.com/product-lines.php#Class+C+%26+B%2B+Motorhomes>)

More Information About Motorhome Chassis Manufacturers>> (<http://thormotorcoach.com/Motorhome-Chassis-Manufacturers.php>)

[BACK TO BLOG MAIN PAGE \(/BLOG/\)](#)

  **SHARE**



EDC COB <edc.cob@edcgov.us>

DR-R18-0001/Saratoga Retail Phase 2 Appeal

1 message

Juanita Brand <jbrand23@gmail.com>

Sun, Oct 7, 2018 at 1:52 PM

To: edc.cob@edcgov.us

Dear El Dorado County Board of Supervisors,

My name is Juanita Brand and I live on Platt Circle in El Dorado Hills. I just learned that you will be reconsidering the approval for a Chick Fil A restaurant with drive through on Saratoga Way, just off of El Dorado Hills Blvd and north of US 50.

I strongly urge you to reconsider letting this restaurant be built. Saratoga Way is my access to my home. When the new houses in Saratoga Estates are built and Wilson is connected to Saratoga, and eventually Saratoga to Iron Point in Folsom, I have nightmares about how awful the traffic will become. Will I even be able to turn left from Finders Way on to Saratoga to exit my neighborhood? To add the congestion of a very popular fast food place on that street will make it even worse and destroy the tranquility of our currently peaceful neighborhood. Please seriously consider the harm you may do to the people who live here.

I'm not a lawyer and cannot cite the laws about driveway access or maintaining a previously agreed upon county plan for development. I just live near this proposed restaurant and hope you will consider not approving it and thus not adding even more terrible traffic to my little neighborhood.

Thank you.
Juanita Brand



EDC COB <edc.cob@edcgov.us>

DR R18-0001 Saratoga Retail Appeal

1 message

Rebecca Eno <rebecca.isbell@ymail.com>

Sun, Oct 7, 2018 at 9:30 PM

To: The BOSONE <bosone@edcgov.us>, BOS Two <bostwo@edcgov.us>, The BOSTHREE <bosthree@edcgov.us>, The BOSFOUR <bosfour@edcgov.us>, The BOSFIVE <bosfive@edcgov.us>, "edc.cob@edcgov.us" <edc.cob@edcgov.us>, John Hidahl <john.hidahl@edcgov.us>

Dear Board of Supervisors,

Please see my attached letter for the appeal of DR R18-0001 Saratoga Retail.

I hope you have had the chance to also go through all of the previous public comments from the prior 2 commissioner hearings. The voices from all who have been concerned about this massive change in scope are important to consider.

Thank You,
Rebecca Eno

2 attachments**Attachment 1 Adams Letter 2017.pdf**

163K

**Eno Letter to the Board_DR R18-0001 Saratoga Retail.docx**

1986K

Subject: **Comment on DR-08-0003 Saratoga Retail**

From: tcadams@pacbell.net

To: charlene.tim@edcgov.us

Cc: john.hidahl@edcgov.us; jvegna@edcgov.us; james.williams@edcgov.us;
roger.trout@edcgov.us; CAmom2345@hotmail.com

Date: Friday, December 8, 2017, 2:53:31 PM PST

Tom & Anne Adams

941 Kings Canyon Dr.

El Dorado Hills, CA 95762-4510

tcadams@pacbell.net

December 8, 2017

Charlene Tim, Clerk of the Planning Commission

County of El Dorado

Planning and Building Department

2850 Fairlane Court

Placerville, CA 95667

charlene.tim@edcgov.us

Dear Ms. Tim:

Subject: Comment on DR-08-0003 Saratoga Retail

We are **Tom & Anne Adams** and we have lived in Park Village for almost 50 years. That is correct, we moved into our home on Kings Canyon Drive in **1968**. ... You can imagine we have experienced considerable changes in our community since the day we moved in. ... But the change being proposed in DR-08-0003 would be the most dramatic – it would impact our small community more than any event in 50 years.

Drive-thru restaurants like Jack-in-the-Box and Taco Bell are open 24 hours a day like a gas station. ... They are across the boulevard ... To remove that planning condition – the separation of the boulevard, invites non-residents into a residential neighborhood in the wee hours ... Approving this proposal, takes Park Village – *the original El Dorado Hills Village* – in the opposite direction of where EDH residential planning is going - Gated Communities.

Gated Communities are the new neighborhood model of El Dorado Hills – a terrific concept. The purpose of living in a gated community is simply that you do not want (*for your safety and the safety of your family*) people driving through your neighborhood who do not live there. Park Village was designed before the Gated Community concept became common place.

Since living in a gated community is an option for anyone, to assume people who live in a non-gated community, must not have those same needs and wants for the safety of their family is very wrong. ... We might conclude that such people do not warrant similar protection and so we can insert a 24/7 business in the middle of their community – no problem.

The 50 year nightmare for us is that in a year, or two, there will be flashing signs on Saratoga directing people driving down from Lake Tahoe at 3:00 AM into Park Village. ... Don't do this to us.

Tom & Anne Adams

On October 9th you will hear 2 appeals from the neighbors of Park Village, Versante and Townhouse Association. It is important to clear up a few things, as it seems there is some misinformation floating around about the motives of the neighborhood opposition and the nature of this dispute.

- 1.) We are all just anti-growth/anti-development. **FALSE!** No one in this group is anti-development in relation to this lot. We are anti DRIVE-THRU on this specific lot. We understand the impact this will have on traffic, noise, pollution, aesthetics, safety of our sidewalk-less streets etc. We would love something we could walk to with our families that would serve our local community as promised in 2009 by the developer. The promise to residents was “non tourist-serving” due to lot size and circulation issues.
- 2.) We knew this would happen when we purchased a home in this neighborhood. **FALSE!** Park Village was built in 1962! Many original owners still live in this neighborhood. The Townhouses directly across from the Saratoga Retail were built in 1972 with many original owners. The very first houses you see on Arrowhead and Mammoth are owned by the original owners, so no, they didn't know a massive drive-thru would be in their back yard. A letter from our of our neighbors and original owner clearly states, this will be the most dramatic change in the 50 years he has lived here (attachment #1)
- 3.) This drive thru will only be open until 10pm. **FALSE!** The Folsom location is now open until 11pm and there is nothing preventing them from being open 24 hours a day. In addition, the drive-thru leasee does not own this land and if this project is approved it will ALWAYS be a drive thru. We don't know what new behemoth of a drive thru could go in here 20 years from now.
- 4.) The project meets all the criteria of Community Design Standards. **FALSE!** The developer clearly cannot comply with many of these standards, but the most obvious ones are #2 and #6.
 - a. (H.2.) Ingress to and egress from a drive-through facility shall be prohibited from driveway(s) directly facing a residential zone.
 - i. There is a clear failure by the planning department to address the use of the word “driveway” in this regulation. A **driveway**, as defined by Merriam-Webster, is a **private road giving access from a public way to a building** on abutting grounds. The public road is Saratoga Way giving access via driveway to the proposed development. Definitions of words cannot be altered to fit the outcome desired by the county or a developer. The County Ordinances and regulations do not provide an alternate definition of driveway.

The county's own findings from 2009 doc (p.3), clearly defines site access by 3 driveways. The findings state: “site access would be provided by three **driveways** along Saratoga way. The northern driveway would be a right-in, right out only while the other two driveways would be full access driveways. A left-turn pocket would be constructed on Saratoga Way to provide access to the main entrance (middle **driveway**).” This speaks to the drive-through standards and the fact that driveways was defined in the county “findings” as the entry point from Saratoga way – all of which face residential lots. Hence, the proposal violates the Community Design Standards adopted by the county just three years ago.

- ii. This Design Standards were put in place in part to regulate PARKING AND LOADING. The intent states:

The purpose of this Chapter is to ensure the provision and maintenance of safe, adequate, and well-designed off-street parking facilities in conjunction with a use or development in order to protect the public health, safety, and welfare. The intent is to reduce road congestion and traffic hazards, to promote storm water quality and management practices, to provide safe and convenient access to businesses, public services, and places of public assembly, and to promote an attractive environment through design and landscape standards for parking areas.

To pretend this regulation is related to lighting—as the Planning Commission staff have done in its evaluation of this project is insulting. The Board adopted a completely different document for Outdoor Lighting Standards. This document was adopted at the same time as the Parking and Loading Standards and covers lighting restrictions that are of “close proximity to the residence or activity area.” The Parking and Loading Document leaves no room for interpretation as the intent of H.2. was to regulate “circulation and traffic control standards” as clearly stated in the Measure H.

- b. It’s impossible for this proposal to adhere to provision H.6. of the Community Design Standards—which pertains to parking and the stacking of cars—due to the lot’s small size. That standard reads: “Stacking areas shall not block access to any parking area or space required of a business.” The Developer may tout that this drive through queue holds 2 more cars than the Folsom location, but as we all know, the Folsom location spills out at least 5-10 cars beyond the capacity of the stacking queue for about 1-3 hours a day (see attachment #2). The county adopted this ordinance to prevent circulation and parking issues. Cars are unable leave and back up at the Folsom location. Once the drive through stacking backs up into the parking area, those spots are no longer available to dine-in patrons as they are blocked until rush hour concludes.

- 5.) This project is just a design review and could have been approved at the Director Level. The developer was just doing the neighbors a service by allowing this to come to public hearing. **FALSE!** The changes to this project were SUBSTANTIAL from the 2009 approval. When the county clearly called out “non-tourist serving” due to the odd parcel shape. The administrative relief findings are tied to the LAND, not to the parking. They knew in 2009 that this land should not be occupied for anything that would draw traveling traffic off highway 50. Therefore this project deviated drastically from the original approved project and must have a public hearing.

In 2009, a design permit was sought by way of application, and that review did occur at the staff level; wherein conditions and findings were issued that allowed the project to be built subject to the mitigation contained in the findings. The county determined that the odd shaped parcel could not accommodate high volumes of traffic circulation and based on the design including **only** non-tourist serving facilities, administrative relief was granted (lack of proper loading, RV parking, large vehicle circulation,). Once a design permit is in place, an applicant can revise the permit, which was done in this case. When a revision is sought, Sec. 130.54.070 is triggered.

Sec. 130.54.070 - Revision to an Approved Permit or Authorization. B. Revisions to a permit or authorization which result in an expansion or **substantial alteration** of the project, or which may affect a condition of approval, mitigation measure, or finding that was specifically addressed by the review authority, may only be approved by said authority following a public hearing.

The project as designed on revision departed from the non-tourist serving condition of approval and as such could not be approved at the director level because the modification is not minor under the code.

Sec. 130.54.070 - Revision to an Approved Permit or Authorization. **The Director may approve a minor modification(s)** when the findings can be made that the modification(s): 1. Does not involve a feature of the project that was specifically addressed in the conditions of approval, mitigation measures, or findings for approval of the project; 2. Does not result in an expansion of the project; 3. Does not substantially alter the original approval decision; and 4. Does not result in changed or new impacts to the surrounding environment that would necessitate modifications to the CEQA document approved for the project.

APAC has strongly urged that this project be denied. They clearly know what this will do to our neighborhood and community. I believe we should respect what the community of El Dorado Hills wants, not some out-of-town developer who bought a strange piece of land. The county should not allow a project or its planning department to side-step the clear, and unambiguous rules in the zoning code. A horrible precedent will follow if the planning department is granted discretionary powers that contradict the laws adopted by the Board. It's setting precedent to follow the rules. It doesn't comply, you can't approve it as written. You need to kick this project back and actually perform the analysis that is required. No short cuts. We have given you all of the arguments to deny this project.

Sincerely,

Rebecca Eno

Park Village Resident

Attachment #2





EDC COB <edc.cob@edcgov.us>

I Support the Drive Thru on Saratoga Way

1 message

Joe Balsama <joebalsama@yahoo.com>

Mon, Oct 8, 2018 at 8:38 AM

Reply-To: Joe Balsama <joebalsama@yahoo.com>

To: "edc.cob@edcgov.us" <edc.cob@edcgov.us>

I am an El Dorado Hills resident, and I support the Drive Thru on Saratoga Way!
I want the tax revenue coming to EDH and NOT Folsom!

Thank you,

Joe Balsama



EDC COB <edc.cob@edcgov.us>

Fwd: Item 40 El Dorado Hills Townhouses Appeal and Item 41 Rebecca Eno Appeal Saratoga Retail Phase 2

1 message

The BOSONE <bosone@edcgov.us>
To: EDC COB <edc.cob@edcgov.us>

Mon, Oct 8, 2018 at 12:01 PM

Kind Regards,

Cindy Munt

Assistant to Supervisor John Hidahl, District 1
Board of Supervisors, County of El Dorado
Phone: (530) 621-5650
CLICK HERE to follow Supervisor Hidahl on Facebook
CLICK HERE to visit Supervisor Hidahl's web page

----- Forwarded message -----

From: **Traci Orlousky** <orlousky@att.net>
Date: Mon, Oct 8, 2018 at 10:56 AM
Subject: Item 40 El Dorado Hills Townhouses Appeal and Item 41 Rebecca Eno Appeal Saratoga Retail Phase 2
To: <bosone@edcgov.us>

To whom it may concern:

Please add this letter/email as a request for a "No Vote" for the project on Saratoga to allow fast food restaurant with drive thru and follow the guidelines of the original design plan for this area. As a homeowner in the area of sixteen years, we purchased our home in this older area for the following reasons.

1. Established area, smaller homes on large lots
2. According to the original plans there were to be no drive thru restaurants allowed to build on the land noted above, bringing down the property values and the tourist traffic from out of town residents etc.
3. Design of this area does not accommodate tourist traffic for a drive thru restaurant nor was it originally intended for that purpose.

Please follow the original design plans for no fast food restaurants to maintain our quality of life in this older area.

Thank you for your consideration.
Traci Orlousky
Matt Orlousky
office/Home -(916) 933-7361

 orlousky.vcf
1K