

December 10, 2013

VIA HAND DELIVERY

Chairman Ron Briggs
El Dorado County Board of Supervisors
330 Fair Lane, Building A
Placerville, California

Re: Appellant's Further Objections to PD12-003A (Green Valley Convenience Ctr)

Dear Supervisor Briggs:

This office has been engaged to represent Amy L Anders ("Ms. Anders"), the appellant of record on item PD12-003A – the Green Valley Convenience Center fueling station/convenience store project ("Project") which will be considered by the Board at a continued hearing today.¹ Ms. Anders owns several commercial and residential properties in the immediate vicinity of the Project that will be adversely affected by the approval and development of the Project. As a result, Ms. Anders is beneficially interested in El Dorado County ("County") discharging its public duty to satisfy the requirements of the California Environmental Quality Act ("CEQA") with respect to this Project.

This letter is submitted in support of Ms. Anders' appeal of the Planning Commission's decision to adopt a mitigated negative declaration ("MND")² and approve the Project and restates and incorporates by reference all other materials submitted by Ms. Anders and others in opposition to this Project. Because the County has received substantial evidence of a fair argument that the Project may cause significant environmental effects, the Board must prepare an environmental impact report ("EIR") prior to approving the project.

¹ The County's acceptance of Ms. Anders' appeal of the Planning Commission's decision to the Board of Supervisors conforms to Section 21151(c) of the Public Resources Code which provides, "If a nonelected decisionmaking body of a local lead agency certifies an environmental impact report, approves a negative declaration or mitigated negative declaration, or determines that a project is not subject to this division, that certification, approval, or determination may be appealed to the agency's elected decisionmaking body, if any." As the County's attorney explained during the proceedings on November 5, 2013 the Board may receive new evidence and consider issues not considered by the Planning Commission in what is called "de novo" review.

² The term "MND" includes the Traffic Impact Analysis prepared by KD Anderson and other reports upon which the MND relies in concluding the Project's environmental impacts will be less-than-significant.

I. CEQA REQUIREMENTS

A. The "Fair Argument" Test

"Since the preparation of an EIR is the key to environmental protection under CEQA—indeed constituting the very heart of the CEQA scheme—accomplishment of CEQA's high objectives requires the preparation of an EIR 'whenever it can be fairly argued on the basis of substantial evidence that the project may have significant environmental impact.' *California Native Plant Society v. County of El Dorado* (2009) 170 Cal.App.4th 1026, 1058 (overturning this County's approval of a "Congregate Care Project" without first preparing an EIR). This policy creates a "strong presumption" in favor of requiring preparation of an EIR. This presumption is reflected in what is known as the "Fair Argument" standard, under which an agency *must* prepare an EIR whenever substantial evidence in the record supports a fair argument that a project may have a significant effect on the environment. *Laurel Heights Improvement Association v. Regents* (1993) 6 Cal.4th 1112, 1123. The CEQA Guidelines state the fair argument test in terms of preparing an EIR:

"If a lead agency is presented with a Fair Argument that a project may have a significant effect on the environment, the lead agency shall prepare an EIR even though it may also be presented with other substantial evidence that the project will not have a significant effect."

14 Cal. C. of Reg. §15064(f)(1) (hereafter "CEQA Guidelines").

"Under the fair argument test, 'deference to the agency's determination is not appropriate and its decision not to require an EIR can be upheld only when there is no credible evidence to the contrary.'" *Center for Sierra Nevada Conservation v. County of El Dorado* (2012) 202 Cal.App.4th 1156, 1173 (overturning this County's adoption of an oak woodland management plan and mitigation fee program for not first certifying an EIR)

B. Evidence to Comply with the "Fair Argument" Test.

The Fair Argument standard "sets a 'low threshold' for requiring preparation of an EIR." *Citizens Action To Serve All Students v. Thornley* (1990) 222 Cal.App.3d 748, 754." Project opponents advocating preparation of an EIR do not need to introduce "overwhelming or overpowering evidence. CEQA does not impose such a monumental burden on appellants." *Stanislaus Audubon Society v. County of Stanislaus* (1995) 33 Cal.App.4th 144, 152 (hereinafter *Stanislaus Audubon*). Instead an EIR shall be prepared in instances where the administrative record contains "enough relevant information and reasonable inference from this information that a fair argument can be made to support a conclusion, *even though other conclusions might also be reached.*" (Emphasis added) *Id.*

(i) Dispute of Expert Opinion

Contested expert testimony amounts to substantial evidence supporting a fair argument that a project may result in a significant environmental impact. "When qualified experts present conflicting evidence on the nature or extent of a project's impacts, the agency must accept the evidence tending to show that the impact might occur. Evidence to the contrary is usually irrelevant, because the agency cannot weight competing evidence. (Citations omitted.)" CEB CEQA Treatise §6.33 at 280-280.1. CEQA Guideline Section 15064(g) also explains this "dispute of expert opinion" rule as follows:

After application of the principles set forth above in Section 15064(f), and in marginal cases where it is not clear whether there is substantial evidence that a project may have a significant effect on the environment, the lead agency shall be guided by the following principle: If there is disagreement among expert opinion supported by facts over the significance of an effect on the environment, the Lead Agency shall treat the effect as significant and shall prepare an EIR.

(ii) Personal Observations

Personal observations by members of the public constitute substantial evidence to support the fair argument test. *Oro Fino Gold Mining Corp. v. County of El Dorado* (1990) 225 Cal.App.3d 872, 882-3 (upholding this County's decision to require EIR for a mining project and noting, "numerous area residents provided evidence of increased traffic and traffic mishaps. Much of the testimony noted that the roads in the area were few, mountainous and narrow. The rapid population growth in recent years, especially among school-age children, was also noted. Again, these were matters within the personal knowledge of the area's residents and constituted evidence for the Board's consideration")

C. Importance of Rules to This Decision

In this instance, as detailed below, the County has received substantial evidence supporting a fair argument that the Project will cause significant environmental effects and should not abuse its discretion in violation of CEQA by approving the Project without first taking the necessary step of preparing an EIR to appropriately address these impacts.

II. THE BOARD OF SUPERVISORS HAS RECEIVED SUBSTANTIAL EVIDENCE THAT THE PROJECT WILL RESULT IN POTENTIALLY SIGNIFICANT TRAFFIC IMPACTS.

The County has received lay and expert testimony impeaching the MND and demonstrating that the Project will result in potentially significant traffic impacts. The fair argument test requires the County to prepare an EIR.

A. Personal Observations and Evidence Submitted by Amy Anders

Ms. Anders repeatedly noted that the "real world" conditions on the ground with respect to traffic congestion along Green Valley Road are not reflected in the MND. Rather, pursuant to oral, photographic, and video evidence submitted into the record of proceedings before the Board of Supervisors on or before November 5, 2013, Ms. Anders demonstrated that Green Valley Road exhibits substantial AM and PM peak traffic congestion in an around the intersection of Sophia Parkway, that a majority of vehicles travel along Green Valley Way at speeds in excess of the posted 50 MPH maximum, and that substantially more traffic accidents occur along this segment of roadway that are assumed in the MND (See, e.g. Public Comment 13-1347 M 159-171 and Ms. Anders' PowerPoint slideshow presentation to the Board of Supervisors on November 5, 2013). Such information reflects substantial evidence of a fair argument that the Project will have significant traffic and safety effects that must be studied in an EIR. *Oro Fino Gold Mining Corp. v. County of El Dorado* (1990) 225 Cal.App.3d 872, 883.

B. Shanteau Letter

A letter prepared by traffic engineer and expert Robert Shanteau dated December 9, 2013 (attached as **Exhibit A**) concisely explains that the MND is fundamentally flawed in that it understates existing conditions, will add substantial traffic to the existing roadways to exceed the adopted threshold of significance, and fails to provide significant mitigation measures in the form of turning lanes to reduce the project's impacts to less than significant levels. In short, the MND's traffic analysis substantially under predicts the significance of traffic impacts from the Project. As a result, these impacts are not reduced to less than significant levels and the Project cannot be approved as proposed.

Importantly, the Shanteau letter need not be found to be superior evidence to that contained in the MND in order to require an EIR. Rather, the evidence itself is sufficient to require an EIR. *California Native Plant Society v. County of El Dorado* (2009) 170 Cal.App.4th 1026, 1060-61 ("We do not mean to imply that the views of these biologists were *superior* to those of John Little, the SEC biologist who reviewed the project for the developer, we merely say that their views were adequate to raise factual conflicts requiring resolution through an EIR. 'It is the function of an EIR, not a negative declaration, to resolve conflicting claims, based on substantial evidence, as to the environmental effects of a project.' (citations omitted) Accordingly, the MND should not have been adopted.").

Indeed, if after careful analysis the EIR reaches the same conclusion, it will be required to summarize the dispute between experts regarding the significance of traffic impacts and explain why the agency chooses to follow one expert over the other. CEQA Guidelines §15151.

III. THE AD HOC "DROP LANE" DOES NOT ADEQUATELY MITIGATE THE PROJECT'S TRAFFIC IMPACTS.

In apparent recognition of and in response to potentially significant traffic impacts resulting from this specific Project identified on November 5th, the Board has asked for proposed mitigation in the form of a "drop lane." As noted by Ms. Anders during the November 5th hearing, she is not a traffic expert and therefore cannot opine as to whether such a "drop lane" will adequately mitigate the Project's significant effects. To this end, Mr. Shanteau was retained to review the proposal made available last week. As explained in more detail in his letter, Mr. Shanteau offers the expert opinion that this ad hoc mitigation measure is still inadequate to sufficiently mitigate the project's traffic effects. According to traffic standards published by Caltrans, the lane should be over 500' in length. The ad hoc lane proposed now is only 65' long – reflecting inadequate mitigation to reduce project traffic impacts to less-than-significant levels.

Accordingly, further mitigation measures and/or project alternatives that would reduce the impact to less-than-significant levels should be considered and vetted through the EIR process.

IV. THE PROJECT CANNOT BE APPROVED PRIOR TO IMPLEMENTATION OF CONCRETE MITIGATION MEASURES TO ADDRESS RIPARIAN HABITAT/WETLANDS ISSUES.

In addition to the deficiencies in the MND's traffic analysis, the Project presents issues with respect to the Project's impacts to riparian habitat and wetlands. The MND notes that the General Plan requires a 50' setback from streams but the Project would only include a 10' setback from the on-site intermittent stream. According to the MND, this is acceptable because mitigation measures will reduce the impact to less than significant levels.

At least two errors flow from this conclusion.

First, the mitigation measures defer analysis and formulating mitigation and therefore do not satisfy CEQA's requirements. *Sundstrom v. County of Mendocino* (1988) 202 Cal.App.3d 296 (deferral of analysis of mitigation measures for hotel project improper). MM BIO-2 and BIO-3 require the applicant to submit a "re-vegetation plan" at a future date (See Staff Memo 8/7/13 13-1347 G 38-40). The plan would be subject further analysis including contingency measures and seeking DFG approval. There is no basis for deferral and the mitigation measures do not commit the agency to a definitive course of action in providing concrete mitigation measures. This renders the mitigation legally inadequate. See *San Joaquin Raptor Rescue Center v. County of Merced* (2007) 149 Cal.App.4th 645, 670 (holding biological resources/venal pool mitigation measures contained in an EIR were inadequate because they were not sufficiently definitive and there was no basis for deferral.) For these reasons, the re-vegetation plan should be developed and approved now as part of the Project rather than at some future date when further analysis may be required.

Second, the Project will involve a fuel station component – the impacts of which are not significantly addressed in the MND. Fuel stations are a major source of water pollution. "In recent years, leaking fuel tanks and spills at gas stations have contaminated drinking water sources for nearby communities, and have become costly for owners to clean up." "Preventing Leaks and Spills at Service Stations: A Guide for Facilities," US EPA, 2003 (attached as **Exhibit B**).³ According to the Utah State University Extension, "Small spills during fueling are bound to happen. Although fuel evaporates rapidly at the land surface it also readily seeps into the soil. Local geology and soil type determine how quickly fuel may reach groundwater supplies or runoff to nearby streams or lakes. Once in the groundwater, fuel contamination is often difficult to clean up. Even small spills or leaks in the same place over time are a potential threat to water resources. The cumulative results of many small spills over time can lead to big problems." (attached as **Exhibit C**).⁴ Because the Project will introduce this contamination source to the water's edge, a potentially significant impact to water quality exists. This impact (with or without the setback) must be evaluated by the County and mitigation measures considered prior to approving the Project.⁵

V. PROCEDURAL MATTER: APPEAL HEARING CANNOT BE BIFURCATED

In an abundance of caution we note the following. According to the "action" link on the County's website regarding the November 5, 2013 hearing, "A motion was made by Supervisor Briggs, seconded by Supervisor Veerkamp, to; 1) Adopt the Mitigated Negative Declaration based on the Initial Study prepared by staff; and 2) Conceptually approve the project, thereby denying the appeal; and 3) Direct staff to return with revised conditions to include a drop lane."

When Ms. Anders asked staff for a copy of the approving resolution and for clarification regarding the scope of today's hearing she was informed, "The notice of determination will be filed after the Board takes its final action. There is no resolution that is adopted when the Board takes action on a project such as this. The Board closed the public hearing previously, but will reopen it with respect to the changes to the conditions as directed by the Board. You will be noticed."⁶

The phrase, "will reopen it with respect to the changes to the conditions as directed by the Board" is troubling in that it appears the County may be inclined to violate a tenet of CEQA by bifurcating CEQA issues from project approval. In short, the public may

³ <http://www.epa.gov/region4/usttoolkit/pdfs/preventingleaksandspillstservicestations.pdf>

⁴ <http://extension.usu.edu/files/publications/factsheet/WQFA-7.pdf>

⁵ Ms. Anders is informed that this property was subject to a 25' setback pursuant to a prior land use approval. The MND fails to explain the discrepancy between applying a 25' setback previously and a 10' setback now. This discrepancy is further evidence that the project must be considered in an EIR.

⁶ Email communication from Tom Dougherty <tom.dougherty@edcgov.us> to Amy Anders dated Monday, Nov 25, 2013 at 9:01 AM.

raise any and all comments on a project prior to the close of final public hearing on the project. "Segregating" or "bifurcating" CEQA review from project approval runs afoul of this rule. *Bakersfield Citizens for Local Control v. City of Bakersfield* (2004) 124 Cal.App.4th 1184, 1200-01 ("If the decision making body elects to certify the EIR without considering comments made at this public hearing, it does so at its own risk. If a CEQA action is subsequently brought, the EIR may be found to be deficient on grounds that were raised at any point prior to close of the hearing on project approval.") Today's hearing to consider whether or not to approve the Project is merely a continuation of Ms. Anders' appeal of the Project – for which County staff concedes no final action has yet occurred.

This means that the continued public hearing on the Project (created by Ms. Anders' appeal) remains open and she, the developer, and other members of the public may still introduce additional arguments and evidence necessary to exhaust administrative remedies and preserve issues. Preventing such participation would result in a prejudicial abuse of discretion and a violation of due process.

VI. RECOMMENDED FURTHER ACTION

In light of the following legal principles and summary of evidence contained in the record of proceedings, Ms. Anders respectfully requests that the Board of Supervisors grant the appeal and remand the Project to staff with directions to prepare an EIR. In the alternative the Board of Supervisors the Board of Supervisors should continue the public hearing to further evaluate the evidence and arguments received today to determine whether a fair argument of significant environmental impact has been made.⁷

Very truly yours,



BRETT S. JOLLEY
Attorney-at-Law

BSJ:lac

Exhibits

⁷ In light of the developer's last minute revocation of its stipulation to continue the November 5, 2013 hearing (see **Exhibit D**) we anticipate the developer would object to continuing the matter today. Nevertheless the law does not allow approval of the Project today.

EXHIBIT A

Robert M. Shanteau, Ph.D., P.E.
Registered Traffic Engineer

13 Primrose Circle
Seaside, CA 93955
email: RMsShant@gmail.com

(831) 394-9420
Cell: (831) 917-0248
FAX: (831) 394-6045

December 9, 2013

Herum Crabtree
5757 Pacific Avenue, Suite 222
Stockton, CA 95207

Attention: Brett Jolley

By email to <BJolley@herumcrabtree.com>

Subject: Peer Review of Traffic Impact Analysis
Green Valley Convenience Center

Dear Mr. Jolley:

At your request, I have reviewed the *Traffic Impact Analysis* for the Green Valley Convenience Center project dated May 23, 2013 (TIA), LOS calculation sheets provided under separate cover dated October 26, 2012 (LOS Calc Sheets), the associated *Revised Mitigated Negative Declaration* dated June 13, 2013 (RMND), and the drawing of the "drop lane" proposed by the project applicant dated . In summary, (1) the TIA has a serious flaw in the evaluation of the existing Level of Service at the Green Valley Road/Sophia Parkway intersection that results in an incorrect assessment of the level of significance of the impact of the additional project-generated traffic; (2) the RMND is in error when it states that the impact of the additional project-generated traffic on the Green Valley Road/Sophia Parkway intersection is not significant; and (3) the "drop lane" does not meet generally accepted highway engineering standards.

1. TIA assessment of LOS at Green Valley Road/Sophia Parkway intersection is incorrect

As shown in Exhibit 2, the TIA states that this intersection is currently operating at LOS B with an average intersection delay of 15.8 sec. At my direction, your client Amy Anders requested County staff to supply her with the documentation supporting this assessment, and she was supplied with LOS calculation sheets for the "Existing plus project" condition. Exhibit 3 is the LOS Calc Sheet for the PM peak period. As noted on this sheet, the number of lanes on the eastbound approach to the intersection was 2, resulting in an approach delay of 18.6 sec (LOS B).

As shown in Exhibit 3, however, the number of eastbound approach lanes is 2 only about 200' west of the intersection. West of that, there is only 1 eastbound approach lane. The result is that after the traffic signal turns green for the eastbound approach and the traffic in the 2 lanes is served (about 15-20 seconds), the rest of the green time only 1 lane is serving the signal. If this effect had been accounted for accurately, the TIA would have found that the existing intersection delay was much greater 15.8 seconds/vehicle and that the intersection was operating

much worse than LOS B.

Exhibit 4 shows how much worse the actual conditions are at the Green Valley Road/Sophia Parkway intersection. This photograph shows that the PM peak queue extends all the way to E. Natoma Street in Folsom, a distance of about a mile. Amy Anders reports that it takes several signal cycles to drive from E. Natoma Street to Sophia Parkway during the PM peak, meaning that the delay is several minutes, or LOS F.

So, instead of the LOS B as reported in the TIA, the Green Valley Road/Sophia Parkway intersection is actually operating at LOS F during the PM peak. This distinction is significant and means that rather than adding traffic to a free-flowing roadway, the project will be adding traffic onto an impacted and slow-moving roadway. This poses a substantial likelihood for more traffic accidents and more traffic delays. I believe there are traffic mitigation measures that can be considered to address this but I have not had the opportunity to conduct such analysis since receiving the information last week. In my professional opinion these options should be evaluated further by the County and circulated for public review and comment -- rather than added as last-minute changes to the project without any analysis.

2. RMND incorrectly states that the additional project-generated traffic results in no significant impact at the Green Valley Road/Sophia Parkway intersection

Exhibit 5 is the page from the the RMND that states, "All intersections except the El Dorado Hills Blvd / Francisco Drive intersection will continue to operate at acceptable levels of service." As shown above, however Green Valley Road/Sophia Parkway intersection is currently operating at LOS F.

Exhibit 6 is the page from the TIA that describes LOS significance thresholds. The TIA states, "The County's General Plan Policy TC-Xe defines worsen as any of the following conditions:

- a. a 2%, increase in traffic during the a.m. peak hour, p.m. peak hour or daily trips, or
- b. the addition of 100 or more daily trips, or
- c. the addition of 10 or more trips during the a.m. peak hour or the p.m. peak hour."

Exhibit 7 from the TIA shows the additional project-generated traffic, which exceeds 10 or more trips during the PM peak hour.

Therefore the additional project-generated during the PM peak will create significant impacts to the intersection of Green Valley Road and Sophia Parkway.

3. The proposed "drop lane" does not meet highway design standards

Exhibit 8 is a drawing of the proposed "drop lane". As most or all local agencies in California, El Dorado County relies on the Caltrans Highway Design Manual (HDM) for guidance and standards in building public roads.

Highway engineers consider a drop lane to be a through lane that is either terminated or becomes a turn lane. The proposed "drop lane" is neither, so it is not actually a drop lane. Highway engineers consider the proposed "drop lane" to be a deceleration lane for the driveway at the northeast corner of the project.

As shown in Exhibit 9, the HDM states, "Deceleration Lane Length -- Design speed of the

roadway approaching the intersection should be the basis for determining deceleration lane length. It is desirable that deceleration take place entirely off the through traffic lanes. Deceleration lane lengths are given in Table 405.2B; the bay taper length is included. Where partial deceleration is permitted on the through lanes, as in Figures 405.2B and 405.2C, design speeds in Table 405.2B may be reduced 10 miles per hour to 20 miles per hour for a lower entry speed. In urban areas where cross streets are closely spaced and deceleration lengths cannot be achieved, the District Traffic branch should be consulted for guidance.”

Table 405.2B shows deceleration lane lengths for various design speeds. The design speed of Green Valley Road is likely 60 mph for a deceleration lane length of 530'. According to Exhibit 8, the “drop lane” is proposed to be 65' long, far shorter than required. Therefore the proposed “drop lane” is much shorter than required by Caltrans standards and will not adequately mitigate the traffic impacts caused by this project. Rather than being added at the last minute without meaningful public input, such proposed mitigation measures and project alternatives should be presented as part of the environmental review process and circulated for public review and comment.

Sincerely,

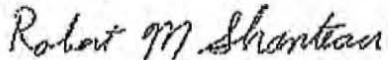

Robert M. Shanteau

- enclosures:
1. Curriculum Vitae of Robert M Shanteau
 2. Page 8, Traffic Impact Analysis
 3. LOS Calculation Sheet
 4. Slide from presentation by Amy Anders to Board of Supervisors
 5. Page 41, Revised Mitigated Negative Declaration
 6. Page 5, Traffic Impact Analysis
 7. Figure 5a, Traffic Impact Analysis
 8. Proposed “drop lane”
 9. Page 400-24, Caltrans Highway Design Manual

Exhibit 1

Robert M. Shanteau, Ph.D., P.E.
13 Primrose Circle Voice: (831) 394-9420
Seaside, CA 93955-4133 FAX: (831) 394-6045
email: rmshant@gmail.com

CURRICULUM VITAE

EDUCATION:

Ph.D. Transportation Engineering, University of California at Berkeley, 1980
M.S. Transportation Engineering, University of California at Berkeley, 1976
B.S. Physics, San Jose State University, 1970

PRESENT POSITION:

Consulting Engineer specializing in the technical aspects of traffic engineering, highway design, and accident reconstruction.

INDUSTRIAL, PUBLIC AGENCY AND ACADEMIC POSITIONS:

Consulting Engineer: 1994-present
Higgins Associates: 1996-1997
Principal Associate
City of Monterey, California: 1989-1994
Traffic Engineer
Dowling Transportation Engineering: 1988-1989
Principal Associate
City of Concord, California: 1986-1988
Traffic Operations Engineer
Acting Transportation Services Manager
Associate Traffic Engineer
Indiana Department of Highways: 1985-1986
Research Engineer
Purdue University: 1980-1985
Assistant Professor of Transportation Engineering

REGISTRATION:

Registered Professional Traffic Engineer
State of California (February 26, 1988)
Certificate Number TR 1476

TRIAL EXPERIENCE:

Qualified as expert 5 times in Monterey County Superior courts, once in Santa Cruz County, twice in Alameda County, once in Los Angeles County, once in Kern County, once in San Francisco City and County, once in Hawaii County, Hawaii

HONORS:

Wayne T. VanWagoner Award for Best Article in ITE Journal, 1988, District 6 Institute of Transportation Engineers
Award of Excellence, Halliburton Educational Foundation, 1984

PROFESSIONAL SOCIETY MEMBERSHIPS:

Institute of Transportation Engineers
Society of Forensic Engineers and Scientists

UNIVERSITY LEVEL COURSES TAUGHT:

Traffic Engineering, Mass Transit Engineering, Airport Engineering, Highway Engineering, Finite Mathematics, Civil Engineering Case Studies

UNIVERSITY EXTENSION COURSES TAUGHT:

Highway Lighting, Traffic Signal Capacity, Traffic Control Device Inventories, Congestion Management, Isolated Signal Timing, Signal Coordination

SELECTED PUBLICATIONS:

- Shanteau, R.M., "Signal Timing for Isolated Congested Intersections," ITE District 6 Meeting, Boise, Idaho, July 1990.
- Shanteau, R.M., "Using Cumulative Curves to Measure Saturation Flow and Lost Time," ITE Journal, October 1988.
- Sinha, Kumares C., Tien-Fang Fwa, Edward C. Ting, Mitsuru Saito, H.L. Michael, and R.M. Shanteau, Interim Report, Indiana Cost Allocation Study: A Report of Methodology, Joint Highway Research Project, Purdue University, West Lafayette, Indiana, March 1984
- Fricker, Jon D., James M. Poturalski, and R.M. Shanteau, Small City Transit Strategies Under the New Federalism, Report CE-TRA-83-1, School of Civil Engineering, Purdue University, December 1983
- Shanteau, R.M., "Considerations in the Length of the Yellow Interval," in Proceedings of the 69th Annual Road School, Purdue University, 1983.
- Shanteau, R.M., P.B. Satterly and G.K. Stafford, Traffic Speed Report No. 117, Joint Highway Research Project, Purdue University, 1983
- Shanteau, R.M., "Improved Manual Methods of Coordinated Signal Timing," in Proceedings of the 68th Annual Road School, Purdue University, 1982.
- Shanteau, R.M., "Estimating the Contributions to Variations of Passenger Loads on Buses at a Point," Transportation Research Record 798, 1981.
- "Techniques for Traffic Planning as Related to Bicycles," Technical Council Information Report, ITE Journal, pp. 26-33, December 1980 (co-authored with ITE Committee 6Y-14).
- Satterly, G.T., and R.M. Shanteau, "A Study of Commuter Shuttle Bus Service on the West Lafayette Campus of Purdue University," School of Civil Engineering, Purdue University, May 1980.
- Shanteau, R.M., Analysis of an Urban Bus Line Servicing a Rapid Transit Station, Dissertation Series UCB-ITS-DS-79-3, Institute of Transportation Studies, University of California, Berkeley, December 1979.
- Shanteau, R.M., "Financial District Route Improvement Program," Recommended Bus System Improvements in San Francisco, Implementation Program, Golden Gate Corridor Project - Phase II, Golden Gate Bridge, Highway and Transportation District, 1979.
- Shanteau, R.M., "Impact of the Rockridge BART Station on AC Transit's 51-58 Bus Line," Technical Memorandum No. 3, BART Impact Project - Traffic, Institute of Transportation Studies, University of California, Berkeley, May 1978.
- Shanteau, R.M., "Bicycle Bottlenecks: Bicycle Planning from a Bicyclist's Point of View," Third National Seminar on the Planning, Design and Implementation of Bicycle and Pedestrian Facilities, Metropolitan Association of Urban Designers and Environmental Planners, December 1974.

SELECTED PRESENTATIONS:

- "Railroad-Highway Grade Crossing Protection in California," at the fall meeting of the Society of Forensic Engineers and Scientists, October 7, 2006
- "Signal Timing for Isolated Congested Intersections" at the Institute of Transportation Engineers District 6 Annual Meeting, Boise, Idaho, 1992.
- "Level of Service" Transportation Agency for Monterey County, 1991.
- "ITE Committee 4A-36 Report: Location of Detector Loops to Reduce Congestion at Intersections," at the Institute of Transportation Engineers Annual Meeting, Orlando, Florida, 1990.

- "Signal Timing for Congestion," East Bay Traffic Engineers, 1989.
- "Do Circular 212 and the new Highway Capacity Manual Fit Together? - Yes!" East Bay Traffic Engineers, 1987.
- "The New Highway Capacity Manual," TRANSPAC (Transportation Advisory Committee of Contra Costa County), 1986.
- "Indiana's Pavement Management System," at the 72nd Annual Purdue Road School, 1986.
- "State Highway Detours and Their Effects on Local Roads and Streets," at the 70th Annual Purdue Road School, 1984 (chairman of session).
- "NETSIM - A Traffic Simulation Model," at the 69th Annual Purdue Road School, 1983 (panelist).
- "Advancements in the Manual Timing of Coordinated Traffic Signals on Arterials," at the 1982 Joint National Meeting of Operations Research Society of America/The Institute of Management Sciences, San Diego, CA, 1982.
- "Estimating the Contributions to Variations in Bus Passenger Loads at a Point," at the 60th Annual Meeting of the Transportation Research Board, Washington, D.C., January, 1981.
- "Analysis of Loads on Buses at a Point," at the 10th Joint Meeting of the Operations Research Society of America and the Institute of Management Science, Colorado Springs, Colorado, November 10-12, 1980.

RESPONSIBLE POSITIONS:

- Member, National Cooperative Highway Research Program, Panel 3-46, Unsignalized Intersections: 1992-1996
- Member, Subcommittee on Bicycle Capacity, Transportation Research Board: 1990-1995
- Member, ITE Committee, Closed Loop Signal Systems: 1990-1992
- Chairman, Technical Advisory Committee, Transportation Agency for Monterey County: 1992-1993
- Member, ITE Intelligent Vehicle/Highway System Advisory Committee: 1990-1991
- Secretary, Northern California VMS Traffic Signal Computer Users Group: 1986-1988
- Member, ITE Committee on Intelligent Vehicle Highway Systems: 1990-1992
- Chairman, ITE Committee 4A-36, Location of Detector Loops to Reduce Congestion at Intersections: 1986-1990
- Member, ITE Committee 4A-16, Use and Timing of Signal Change Intervals: 1984-1986
- Member, ITE Committee 5EE, Bike Routes: 1981-1983
- Member, ITE Committee 6Y-14, Planning for Bicycle Transportation: 1978-1981
- Member, West Lafayette, Indiana, Traffic Commission: 1981-1986
- Member, Transportation Research Board Committee A3A11, Traffic Flow Theory Committee: 1984- 1986
- Member, Transportation Research Board Committee A3A18, Traffic Signal Systems Committee: 1984-1985
- Chairman, Technical Committee, Indiana Section ITE: 1982-1985
- Designated Advisor, Bus Priority Technique Study, Technical Advisory Committee, AC Transit: 1978
- Member, Chancellor's Ad Hoc Committee on Transportation and Parking, University of California, Berkeley: 1977

SPECIAL TRAINING/EXTENSION COURSES ATTENDED:

- Traffic Impact Studies, presented by ITE: 1990
- Highway Capacity Software, presented by the McTrans Center of the University of Florida: 1990
- Risk Management and Traffic Safety, presented by ITS Extension, UC Berkeley: 1989
- Safety through Construction and Maintenance Zones, presented by ITS Extension, UC Berkeley: 1986
- Transportation Studies: Data Collection and Analysis with Microcomputer, presented by ITS Extension, UC Berkeley: 1986
- Traffic Accident Reconstruction, presented by Traffic Institute of Northwestern University: 1985

Exhibit 2

**TABLE 2
EXISTING PEAK HOUR LEVELS OF SERVICE AT INTERSECTIONS**

Location	Control	AM Peak Hour Intersection		PM Peak Hour Intersection		Traffic Signal Warranted?
		LOS	Average Delay	LOS	Average Delay	
1. Green Valley Rd / Sophia Parkway	Signal	B	15.6	B	15.8	N/A
2. Green Valley Rd / Mormon Island Dr	Signal	A	6.4	A	5.1	N/A
3. Green Valley Rd / Hidden Acres Dr	Signal	A	3.0	A	4.5	N/A
4. Green Valley Rd / Francisco Dr	Signal	C	34.3	D	48.1	N/A
5. Green Valley Rd / El Dorado Hills Blvd - Salmon Falls Rd	Signal	E	74.1	E	65.1	N/A
6. El Dorado Hills Blvd / Francisco Dr	AWS					Yes
Overall		F	107.6	F	59.7	
NB		F	163.7	F	83.8	
SB		E	45.3	B	13.5	
EB		F	112.2	F	38.5	
WB		C	19.8	B	11.9	
7. Sophia Parkway / Elmores Way	AWS					No
Overall		A	8.0	A	8.9	
NB		A	7.7	A	9.7	
SB		A	8.3	A	8.2	
EB		A	8.9	A	9.1	
WB		A	7.6	A	7.8	

AWS - all way stop,

KSDA

Only true for about 200'. Rest of approach is 1 lane.

Movement	EBL	EBT	EBP	WBU	WBL	WBT	WBR	NBU	NBL	NBT	NBR	SBL	SBT	SBR
Lane Configurations	1	2	1	1	<1	>2	0	0	<1	<1	1	0	<1>	0
Volume (vph)	1	1481	115	94	149	901	0	23	129	0	242	2	4	16
Ideal Flow (vphpl)	1900	1900	1900	1900	1900	1900	1900	1900	1900	1900	1900	1900	1900	1900
Total Lost time (s)	4.0	4.0	4.0	4.0	4.0	4.0			4.0	4.0	4.0		4.0	
Lane Util. Factor	1.00	0.95	1.00	0.91	0.95	0.95			0.95	0.95	1.00		1.00	
Frt	1.00	1.00	0.85	1.00	1.00	1.00			1.00	1.00	0.85		0.90	
Flt Protected	0.95	1.00	1.00	0.95	0.95	1.00			0.95	0.95	1.00		1.00	
Satd. Flow (prot)	1770	3539	1583	1610	1681	3539			1681	1681	1583		1670	
Flt Permitted	0.95	1.00	1.00	0.95	0.95	1.00			0.95	0.95	1.00		1.00	
Satd. Flow (perm)	1770	3539	1583	1610	1681	3539			1681	1681	1583		1670	
Peak-hour factor, PHF	0.92	0.92	0.92	0.92	0.92	0.92	0.92	0.92	0.92	0.92	0.92	0.92	0.92	0.92
Adj. Flow (vph)	1	1610	125	102	162	979	0	25	140	0	263	2	4	17
RTOR Reduction (vph)	0	0	57	0	0	0	0	0	0	0	232	0	16	0
Lane Group Flow (vph)	1	1610	68	92	172	979	0	0	82	83	31	0	7	0
Turn Type	Prot	NA	Perm	Prot	Prot	NA		Split	Split	NA	Perm	Split	NA	
Protected Phases	7	4		3	3	8		2	2	2		6	6	
Permitted Phases			4								2			
Actuated Green, G (s)	0.7	45.9	45.9	10.1	10.1	55.3			9.8	9.8	9.8		2.5	
Effective Green, g (s)	0.7	45.9	45.9	10.1	10.1	55.3			9.8	9.8	9.8		2.5	
Actuated g/C Ratio	0.01	0.54	0.54	0.12	0.12	0.66			0.12	0.12	0.12		0.03	
Clearance Time (s)	4.0	4.0	4.0	4.0	4.0	4.0			4.0	4.0	4.0		4.0	
Vehicle Extension (s)	3.0	3.0	3.0	3.0	3.0	3.0			3.0	3.0	3.0		3.0	
Lane Grp Cap (vph)	14	1926	861	192	201	1111			195	195	184		49	
v/s Ratio Prot	0.00	c0.45		0.06	c0.10				0.05	c0.05			c0.00	
v/s Ratio Perm			0.04								0.02			
v/c Ratio	0.07	0.84	0.08	0.48	0.86	0.22			0.42	0.43	0.17		0.13	
Uniform Delay, d1	41.5	16.1	9.1	34.6	36.4	6.9			34.6	34.6	33.6		39.8	
Progression Factor	1.00	1.00	1.00	1.00	1.00	1.00			1.00	1.00	1.00		1.00	
Incremental Delay, d2	2.2	3.3	0.0	1.9	28.2	0.1			1.5	1.5	0.4		1.2	
Delay (s)	43.6	19.4	9.2	36.5	64.5	7.0			36.1	36.1	34.0		41.1	
Level of Service	D	B	A	D	E	A			D	D	C		D	
Approach Delay (s)		18.6				17.2				34.8			41.1	
Approach LOS		B				B				C			D	
Intersection Summary														
HCM 2000 Control Delay				20.3										C
HCM 2000 Volume to Capacity ratio				0.75										
Actuated Cycle Length (s)				84.3									16.0	
Intersection Capacity Utilization				79.3%										D
Analysis Period (min)				15										
c Critical Lane Group														

Exhibit 1

Exhibit 3

Wrong number of approach lanes makes this calculation wrong.

Existing Congestion

- Site Visit
 - Nov. 4, 2013
 - PM PEAK 5:30 p.m.
- Everyone Knows This!



Exhibit 5

Revised Initial Study/Environmental Checklist
 PD12-0003/Green Valley Convenience Center
 Page 41

Potentially Significant Impact	Potentially Significant Unless Mitigation Incorporation	Less Than Significant Impact	No Impact
--------------------------------	---	------------------------------	-----------

XVI. TRANSPORTATION/TRAFFIC. <i>Would the project:</i>			
e. Result in inadequate emergency access?			X
f. Conflict with adopted policies, plans, or programs regarding public transit, bicycle, or pedestrian facilities, or otherwise decrease the performance or safety of such facilities?			X

Discussion: A substantial adverse effect on Traffic would occur if the implementation of the project would:

- Result in an increase in traffic, which is substantial in relation to the existing traffic load and capacity of the street system;
- Generate traffic volumes which cause violations of adopted level of service standards (project and cumulative); or
- Result in, or worsen, Level of Service "F" traffic congestion during weekday, peak-hour periods on any highway, road, interchange or intersection in the unincorporated areas of the county as a result of a residential development project of 5 or more units.

a-b. **Traffic Increases, Levels of Service Standards:** This project lies on the south side of Green Valley Road at the south east corner of the intersection with Sophia Parkway. The project seeks encroachments onto both roads. East at Sophia Parkway, Green Valley Road has been improved to a four-lane road with curb, gutter, sidewalks and a striped median. The Mormon Island Dam, one of the dams containing Folsom Lake is directly across Green Valley Rd from the project and is currently undergoing improvements in both the El Dorado County and the City of Folsom. Once the improvements to the dam are complete, the County will coordinate the new alignment and improvements of Green Valley Road with the City of Folsom and improvements to Green Valley Road west of Sophia Parkway would be completed.

The 2004 General Plan Transportation Policies under TC-X require that that projects that "worsen" traffic by two percent, or 10 peak hour trips, or 100 average daily trips construct (or ensure funding and programming) of improvements to meet Level of Service standards in the General Plan Transportation and Circulation Element.

Green Valley Road and Sophia Parkway are County maintained roadways and adjoin the project on two sides. The project proposes two new encroachments, one each onto those roads. Access and circulation driveways have been analyzed by DOT and the El Dorado Hills Fire Department and found by both to be adequate for interior circulation as conditioned.

As required by County policy, a traffic study was prepared to analyze the potential traffic impacts resulting from the project. According to the Traffic Impact Analysis, May 23, 2013, Attachment 14; and Arco AM PM Left Turn Analysis, January 16, 2013, Attachment 15, the project would cause an increase in traffic on area roadways and intersections of approximately 1,480 daily trips on a weekday basis. After discounting passby and internally captured trips the new trips generated by this project will be 113 a.m. peak hour trips and 125 p.m. peak hour trips. The proposed project would result in less than significant impacts under both existing plus proposed project and 2017 plus proposed project conditions. These levels are less than the cumulative analysis completed by the 2004 General Plan E.I.R.

All intersections except the El Dorado Hills Blvd / Francisco Drive intersection will continue to operate at acceptable levels of service. The county has identified this intersection for improvement in their Capital Improvement Program, CIP 71358 Francisco Drive Right-Turn Pocket (design year 12/13, construction year 13/14) and CIP 72332 El Dorado Hills Boulevard/Francisco Drive Intersection Alignment which is presently unfunded but

Exhibit 6

and through-right lanes. The El Dorado Hills Blvd approach includes a left turn lane and a through-right lane while the Salmon Falls Road intersection includes a left-through lane and a right turn lane; the El Dorado Hills Blvd – Salmon Falls Road approaches are split phased while the Green Valley Drive approaches are protected.

The **Francisco Drive / El Dorado Hills Blvd intersection** provides access from US 50 to the south to two main intersections along Green Valley Road. The intersection is a four way intersection and is currently all way stop controlled. The Francisco Drive approaches include a single left-through-right lane while the El Dorado Hills Blvd approaches include left turn lanes and through-right lanes.

The **Sophia Parkway / Elmores Way intersection** provides access between Green Valley Road and East Natoma Street in Folsom. The intersection is all-way stop controlled. Sophia Parkway consists of left turn lanes and through-right lanes in both north and southbound directions. Elmores Way includes a left-through-right lane along the eastbound approach and left-through and right only lanes along the westbound approach.

Level of Service Analysis

Methodology. *Level of Service Analysis* has been employed to provide a basis for describing existing traffic conditions and for evaluating the significance of project traffic impacts. Level of Service measures the *quality* of traffic flow and is represented by letter designations from "A" to "F", with a grade of "A" referring to the best conditions, and "F" representing the worst conditions. The guidelines and analyses used for this report follow El Dorado County standards.

Local agencies adopt minimum Level of Service standards for their facilities. El Dorado County identifies LOS 'E' as the acceptable Level of Service on roadways and state highways within the unincorporated areas of the County in the Community Regions and LOS D in the Rural Centers and Rural Regions except as specified in the General Plan. Four roadway segments, none of which are part of this study, allow LOS F conditions after 2008. The *2000 Highway Capacity Manual* was used to provide a basis for describing existing traffic conditions and for evaluating the significance of project traffic impacts. Intersection levels of service presented in this analysis are based on the weighted average total delay per vehicle for the intersection as a whole based on the thresholds shown in Table 1.

Intersection Thresholds. An impact is considered significant if the project causes an intersection to change from LOS E to LOS F. Worsening of existing facilities already operating at unacceptable levels of service is also considered a significant impact. The County's General Plan Policy TC-Xe defines worsen as any of the following conditions:

- a. a 2% increase in traffic during the a.m. peak hour, p.m. peak hour or daily trips, or
- b. the addition of 100 or more daily trips, or
- c. the addition of 10 or more trips during the a.m. peak hour or the p.m. peak hour.

Exhibit 7

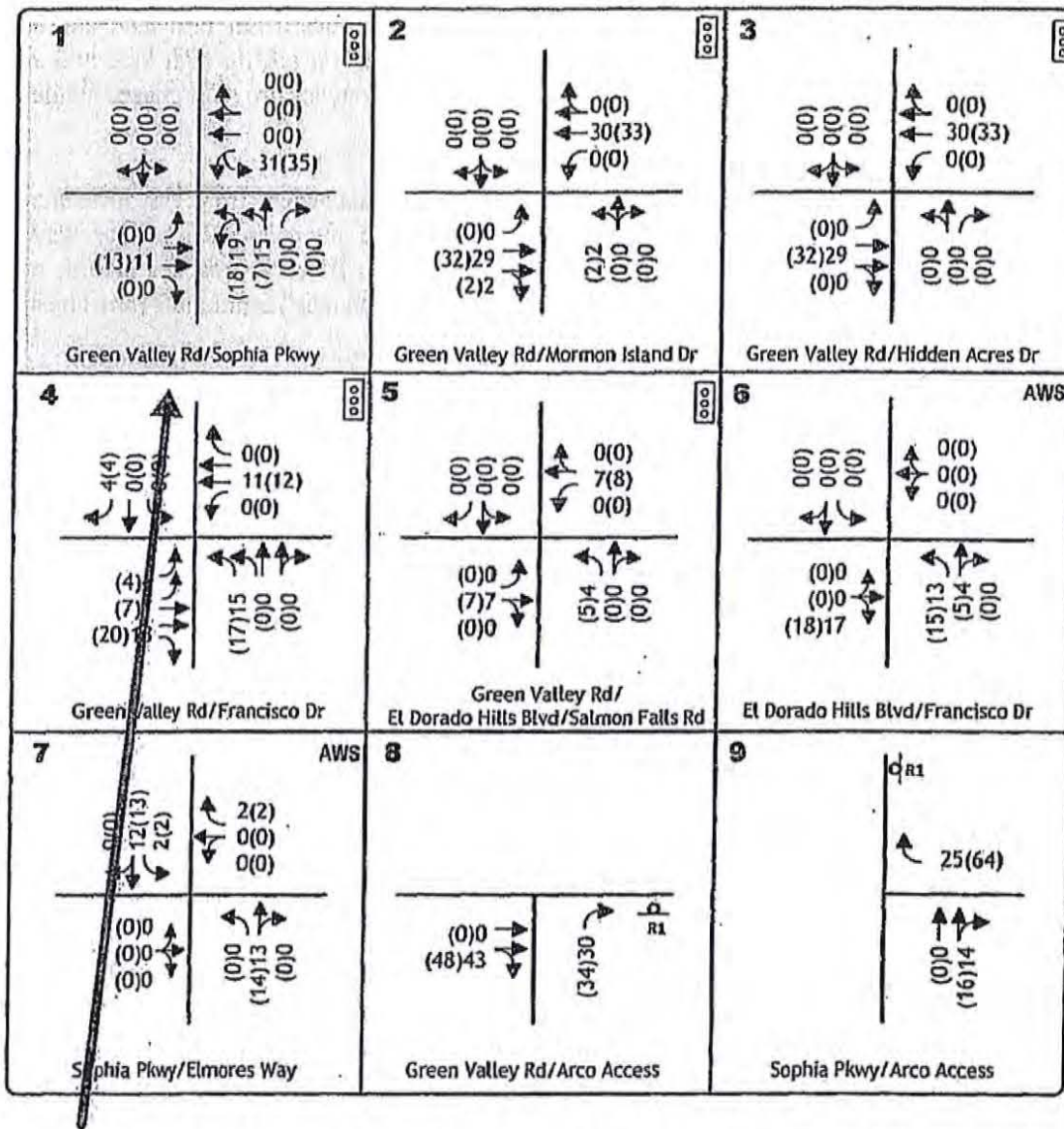

Proposed project adds more than 10 trips to LOS F intersection during PM peak hour.

Legend

- ↔ XX AM Peak Hour Volume
- ↔ (XX) PM Peak Hour Volume
- AWS All Way Stop
- ☐ Signalized Intersection

DROP LANE / MEDIAN EXHIBIT

13 NOV 20 AM 8:26
 RECEIVED
 PLANNING DEPARTMENT

SITE DEVELOPMENT NOTES

- 1. EXISTING PAVED AREAS WITH MAXIMUM 2% SLOPE PLANS
- 2. NEW ASPHALT PAVEMENT
- 3. FOR DRIVEWAY & POLE BENCH EXISTING, NEW, PER OWNER REQUIREMENTS
- 4. NEW DRIVEWAY FOR EXISTING DRIVEWAY
- 5. NEW ASPHALT SIDE FOR DRIVEWAY, PLANS FOR UNDER EXISTING DRIVEWAY
- 6. NEW DRIVEWAY CURB CUT
- 7. NEW DRIVEWAY DRIVE
- 8. NEW 2'-WIDE WALKWAY SIDEWALK
- 9. NEW DRIVEWAY SIDEWALK
- 10. DRIVEWAY SIDEWALK
- 11. DRIVEWAY SIDEWALK
- 12. DRIVEWAY SIDEWALK
- 13. DRIVEWAY SIDEWALK
- 14. DRIVEWAY SIDEWALK
- 15. DRIVEWAY SIDEWALK
- 16. DRIVEWAY SIDEWALK
- 17. DRIVEWAY SIDEWALK
- 18. DRIVEWAY SIDEWALK
- 19. DRIVEWAY SIDEWALK
- 20. DRIVEWAY SIDEWALK
- 21. DRIVEWAY SIDEWALK
- 22. DRIVEWAY SIDEWALK
- 23. DRIVEWAY SIDEWALK
- 24. DRIVEWAY SIDEWALK
- 25. DRIVEWAY SIDEWALK
- 26. DRIVEWAY SIDEWALK
- 27. DRIVEWAY SIDEWALK
- 28. DRIVEWAY SIDEWALK
- 29. DRIVEWAY SIDEWALK
- 30. DRIVEWAY SIDEWALK
- 31. DRIVEWAY SIDEWALK
- 32. DRIVEWAY SIDEWALK
- 33. DRIVEWAY SIDEWALK
- 34. DRIVEWAY SIDEWALK
- 35. DRIVEWAY SIDEWALK
- 36. DRIVEWAY SIDEWALK
- 37. DRIVEWAY SIDEWALK
- 38. DRIVEWAY SIDEWALK
- 39. DRIVEWAY SIDEWALK
- 40. DRIVEWAY SIDEWALK
- 41. DRIVEWAY SIDEWALK
- 42. DRIVEWAY SIDEWALK
- 43. DRIVEWAY SIDEWALK
- 44. DRIVEWAY SIDEWALK
- 45. DRIVEWAY SIDEWALK
- 46. DRIVEWAY SIDEWALK
- 47. DRIVEWAY SIDEWALK
- 48. DRIVEWAY SIDEWALK
- 49. DRIVEWAY SIDEWALK
- 50. DRIVEWAY SIDEWALK
- 51. DRIVEWAY SIDEWALK
- 52. DRIVEWAY SIDEWALK
- 53. DRIVEWAY SIDEWALK
- 54. DRIVEWAY SIDEWALK
- 55. DRIVEWAY SIDEWALK
- 56. DRIVEWAY SIDEWALK
- 57. DRIVEWAY SIDEWALK
- 58. DRIVEWAY SIDEWALK
- 59. DRIVEWAY SIDEWALK
- 60. DRIVEWAY SIDEWALK
- 61. DRIVEWAY SIDEWALK
- 62. DRIVEWAY SIDEWALK
- 63. DRIVEWAY SIDEWALK
- 64. DRIVEWAY SIDEWALK
- 65. DRIVEWAY SIDEWALK
- 66. DRIVEWAY SIDEWALK
- 67. DRIVEWAY SIDEWALK
- 68. DRIVEWAY SIDEWALK
- 69. DRIVEWAY SIDEWALK
- 70. DRIVEWAY SIDEWALK
- 71. DRIVEWAY SIDEWALK
- 72. DRIVEWAY SIDEWALK
- 73. DRIVEWAY SIDEWALK
- 74. DRIVEWAY SIDEWALK
- 75. DRIVEWAY SIDEWALK
- 76. DRIVEWAY SIDEWALK
- 77. DRIVEWAY SIDEWALK
- 78. DRIVEWAY SIDEWALK
- 79. DRIVEWAY SIDEWALK
- 80. DRIVEWAY SIDEWALK
- 81. DRIVEWAY SIDEWALK
- 82. DRIVEWAY SIDEWALK
- 83. DRIVEWAY SIDEWALK
- 84. DRIVEWAY SIDEWALK
- 85. DRIVEWAY SIDEWALK
- 86. DRIVEWAY SIDEWALK
- 87. DRIVEWAY SIDEWALK
- 88. DRIVEWAY SIDEWALK
- 89. DRIVEWAY SIDEWALK
- 90. DRIVEWAY SIDEWALK
- 91. DRIVEWAY SIDEWALK
- 92. DRIVEWAY SIDEWALK
- 93. DRIVEWAY SIDEWALK
- 94. DRIVEWAY SIDEWALK
- 95. DRIVEWAY SIDEWALK
- 96. DRIVEWAY SIDEWALK
- 97. DRIVEWAY SIDEWALK
- 98. DRIVEWAY SIDEWALK
- 99. DRIVEWAY SIDEWALK
- 100. DRIVEWAY SIDEWALK

Proposed 60' "drop lane"

GREEN VALLEY ROAD

1 DROP LANE EXHIBIT - LARGE SCALE SCALE: 1" = 20'-0"

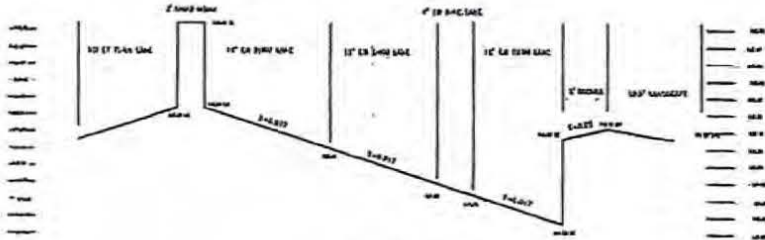



CROSS SECTION A-A
 EASTBOUND GREEN VALLEY ROAD
 (AT STORM DRAIN INLET TO BE RELOCATED)
 1" = 1' H
 1" = 16' V

LEGEND:
 1. SEE EXISTING PLAN (20' X 20' GRID)
 2. SEE EXISTING PLAN (20' X 20' GRID)
 3. SEE EXISTING PLAN (20' X 20' GRID)

CALL USA
 DISORDERING SERVICE ALERT
 48 HOURS PRIOR TO CONSTRUCTION
 CALL TOLL FREE: 1-800-327-2600

UTILITY CONFLICT NOTICE:
 THE CONTRACTOR SHALL BE RESPONSIBLE FOR VERIFYING THE LOCATION, DEPTH, AND TYPE OF ALL UTILITIES PRIOR TO ANY CONSTRUCTION. THE CONTRACTOR SHALL BE RESPONSIBLE FOR ANY DAMAGE TO UTILITIES. THE CONTRACTOR SHALL BE RESPONSIBLE FOR ANY DAMAGE TO UTILITIES. THE CONTRACTOR SHALL BE RESPONSIBLE FOR ANY DAMAGE TO UTILITIES.

Preliminary Not For Construction

THIS SHEET IS FOR INFORMATION ONLY

ARCO INTL
 2500 8th Ave
 17700 CAN WASH
 FUEL CUTOFF 1000 BARO
 AND 1,000 OF CLEL

GREEN VALLEY ROAD
 13-1347-2B
 11/13/13

FACILITY # TUD

SITE PLAN
 TURN-OUT

SUPPLEMENT
 C2.0 OF

Exhibit 8

lengths of 60 feet and 90 feet are normally used. Where space is restricted and speeds are low, a 60-foot bay taper is appropriate. On rural high-speed highways, a 120-foot length is considered appropriate.

(d) Deceleration Lane Length -- Design speed of the roadway approaching the intersection should be the basis for determining deceleration lane length. It is desirable that deceleration take place entirely off the through traffic lanes. Deceleration lane lengths are given in Table 405.2B; the bay taper length is included. Where partial deceleration is permitted on the through lanes, as in Figures 405.2B and 405.2C, design speeds in Table 405.2B may be reduced 10 miles per hour to 20 miles per hour for a lower entry speed. In urban areas where cross streets are closely spaced and deceleration lengths cannot be achieved, the District Traffic branch should be consulted for guidance.

(e) Storage Length -- At unsignalized intersections, storage length may be based on the number of turning vehicles likely to arrive in an average 2-minute period during the peak hour. At a minimum, space for 2 vehicles should be provided at 25 feet per vehicle. If the peak hour truck traffic is 10 percent or more, space for at least one passenger car and one truck should be provided. Bus usage may require a longer storage length and should be evaluated if their use is anticipated.

At signalized intersections, the storage length may be based on one and one-half to two times the average number of vehicles that would store per signal cycle depending on cycle length, signal phasing, and arrival and departure rates. At a minimum, storage length should be calculated in the same manner as unsignalized intersection. The District Traffic Branch should be consulted for this information.

**Table 405.2A
Bay Taper for Median
Speed-change Lanes**

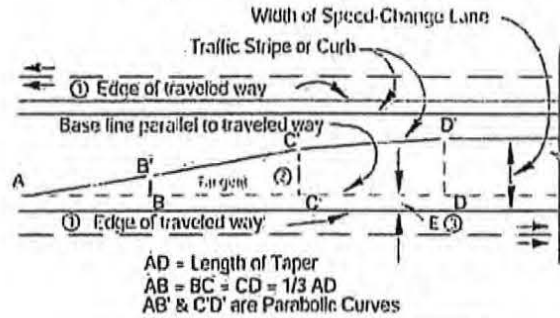

LENGTH OF TAPER - feet			OFFSET DISTANCE			
60	90	120	DD' = 10'	DD' = 11'	DD' = 12'	
Distance From Point "A"			0.00	0.00	0.00	
5	7.5	10.0	0.16	0.17	0.18	
10	15.0	20.0	0.62	0.69	0.75	
15	22.5	30.0	1.11	1.55	1.63	
B'	20	30.0	40.0	2.50	2.75	3.00
	30	45.0	60.0	5.00	5.50	6.00
C'	40	60.0	80.0	7.50	8.25	9.00
	45	67.5	90.0	8.59	9.45	10.31
	50	75.0	100.0	9.38	10.31	11.25
	55	82.5	110.0	9.81	10.83	11.81
	60	90.0	120.0	10.00	11.00	12.00

NOTES:

- (1) The table gives offsets from a base line parallel to the edge of traveled way at intervals measured from point "A". Add "E" for measurements from edge of traveled way.
- (2) Where edge of traveled way is a curve, neither base line nor taper between B & C will be a tangent. Use proportional offsets from B to C.
- (3) The offset "E" is usually 2 ft along edge of traveled way for curbed medians; Use "E" = 0 ft. for striped medians.

**Table 405.2B
Deceleration Lane Length**

Design Speed (mph)	Length to Stop (ft)
30	235
40	315
50	435
60	530

EXHIBIT B



Water is Life : Quality Matters



HOW TO PROTECT YOUR WATER FROM SPILLED FUEL

Fact Sheet 4
Revised
March 2012

INSIDE:

- FUEL HANDLING
- ABOVEGROUND STORAGE TANKS
 - Recommendations on Protecting Water
 - Safety Considerations
 - Special Considerations
- UNDERGROUND STORAGE TANKS
 - Regulated Underground Storage Tanks
- MONITORING
 - If You Find a Leak
 - Closing Tanks
- CONTACTS & REFERENCES
- GLOSSARY

Fuel spills and leaks pose a serious threat to human health and environmental quality. One gallon of gasoline can contaminate up to 1 million gallons of water. Cleanup of fuel-contaminated soil and water can be extremely difficult and expensive. It is best to take precautions to ensure that spills or leaks do not occur. This fact sheet provides basic guidelines for reducing the potential risk of water contamination from handling and storage of fuel such as diesel, gasoline, and home heating oil.

For additional information or reading materials, refer to contacts and references section at the end of this fact sheet.

FUEL HANDLING

Small spills during fueling are bound to happen. Although fuel evaporates rapidly at the land surface it also readily seeps into the soil. Local geology and soil type determine how quickly fuel may reach groundwater supplies or runoff to nearby streams or lakes. Once in the groundwater, fuel contamination is often difficult to clean up. Even small spills or leaks in the same place over time are a potential threat to water resources. The cumulative results of many small spills over time can lead to big problems.

To protect water resources from fuel spills, take care to reduce any potential leaks and spills during fuel transfers. Always supervise fuel transfers from storage tanks to equipment, replace leaking or defective nozzles and use a can to catch any dripping that may occur after shutting off the fuel nozzle. To meet Utah state fire codes, always post a "No Smoking" sign and enforce a no smoking rule at the fuel handling and storage facility. Keep fuel pumps and nozzles secure from children and vandalism, and label each pump or nozzle as to the type of fuel dispensed.



TAKE ACTION!

- Supervise fuel transfers from storage tanks to equipment.
- Replace leaking or defective nozzles.
- Install a breakaway and an automatic shutoff on the nozzle of each pump.

ABOVEGROUND STORAGE TANKS (ASTs)

The use of above ground storage tanks (ASTs) is the preferred choice for storing gasoline, propane, heating oil, and diesel on farmsteads or acreages. Compared to underground tanks, ASTs provide easy access and greater opportunity to observe and monitor tanks for leaks. However, special care must be taken with ASTs to protect them from impact by farm equipment and personal vehicles. To protect against the rare event of an explosion, ASTs need to be placed as far as possible from livestock facilities and human dwellings. Choose a site where farm vehicles can easily maneuver for fueling.

Recommendations on Locating an AST to Protect Ground and Surface Water

Locate fuel tanks as far as reasonably possible from wells. Generally, you should try to locate a new tank downslope and at least 250 feet from your well. Avoid areas with porous, corrosive or wet soils or sites that contain abandoned drainage tiles or previously disposed waste materials. Also avoid designated flood plain areas or areas where the water table is close to the surface.

The tank should not be in contact with bare soil. All tanks should be within a secondary containment system with sufficient holding capacity for the contents of the existing tank (or largest tank for multiple-tank facilities) plus a 10% freeboard.

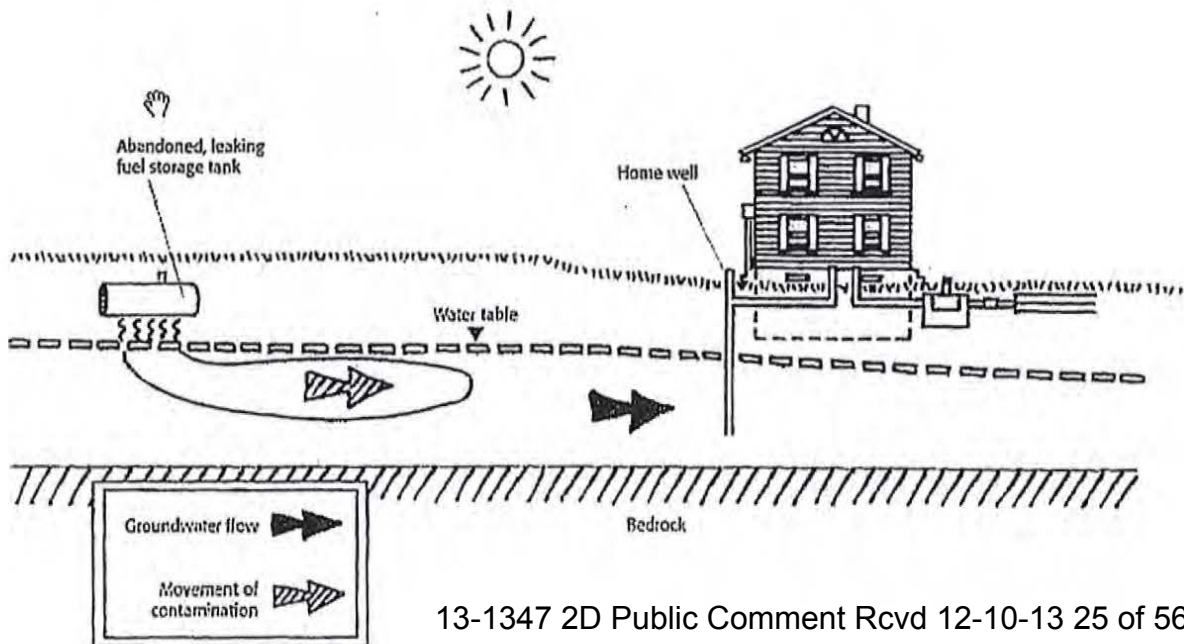

Safety Considerations for an AST

Underground storage tanks should never be reused as aboveground storage tanks. This practice is not only illegal, but also dangerous. Your AST must comply with state and local rules for electrical safety and for fire prevention. Check with your local fire department for details on fire code. At a minimum, follow these safety recommendations for all ASTs:

1. Keep a fire extinguisher in close proximity.
2. Locate ASTs at least 50 feet from any building or combustible storage.
3. Label tank contents along with health and physical hazards.
4. Display a "No Smoking" sign.
5. Secure against vandalism or tampering.
6. If the AST is top-opening only, place tank on a non-combustible surface.
7. If the AST has gravity discharge, equip it with a heat-actuated shut-off valve at the discharge opening, and a self-closing valve at the fuel dispensing hose.
8. Use a light colored tank to avoid heating problems
9. Enclose wiring in a conduit.
10. Above ground piping must be made of steel and coated to prevent corrosion.
11. All piping within a dike must be above ground and must extend over, rather than through, the dike wall.

TAKE ACTION!

Write a Spill Prevention Control and Countermeasure (SPCC) plan. It should be approved and certified by a registered professional engineer. The plan needs to be updated every three years. Check with your local fire department for details.

Special Considerations

In most cases, the installation of an AST with a capacity of less than 660 gallons does not require a permit. However, the location of an AST may put

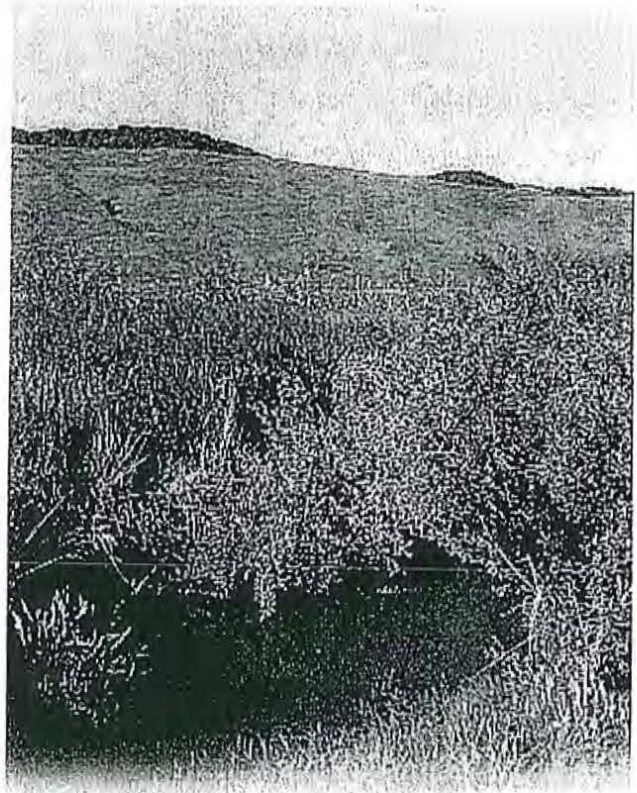

environmentally sensitive waters at risk, and in these cases special precautions must be taken. Keep the following considerations in mind:

- Community water supplies are required by law to protect an area around their source from potential contaminants. If a proposed fuel tank is within a contamination zone for a community water supply, the Utah Division of Drinking Water has specific regulations for the construction of the tank. To find out if these regulations apply to you, contact the Division of Drinking Water.

- Tanks placed in environmentally sensitive areas, such as flood plains or areas with a shallow water table, may be subject to local rules and require special installation. For example, a double walled tank may be necessary in these situations because it provides greater protection than other tank designs. Contact the Utah Division of Environmental Response and Remediation (DERR) for more information about placing tanks in these areas.

UNDERGROUND STORAGE TANKS (USTs)

Underground storage tanks are no longer the preferred means of storing fuel on your farmstead or acreage. Anyone who has a UST should take special care that the tanks are in good condition and are not leaking. A primary factor in leaking tanks is age and type. Steel tanks need special corrosion protection prior to installation. Older tanks made of unprotected steel are subject to corrosion that weakens the tank walls and seams, eventually creating a leak. If you have a steel UST that is more than 15 years old, consider replacing the tank with a new underground storage tank or an aboveground storage tank.

TAKE ACTION!

Check tanks regularly for leaks and keep good records about locations, age and construction of any tanks on your property.

Federal and state environmental regulations do not apply to farm or residential tanks which hold 1,100 gallons or less of motor fuel, are not used for commercial purposes, or for tanks storing heating oil to be used on the premises. Even if your underground storage tank is not covered by environmental regulations, you should take the precautions to prevent contamination of water resources. Make sure that the tank meets new tank standards. Avoid locating the tank near a water supply, where there is standing water, or where the water table is close to the surface at any time of the year. Consider installing a spill and overflow protection (such as a catch basin to collect

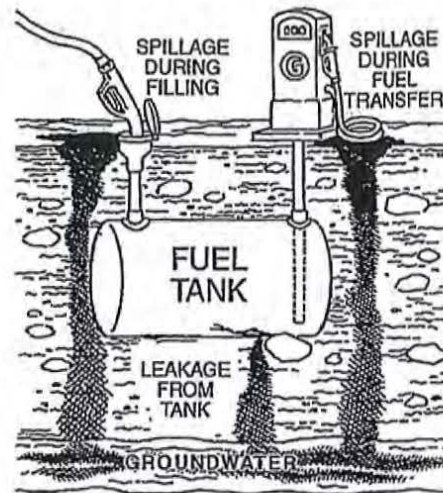

spills when the tank is filled) and an automatic shut-off or buzzer. Utah's Division of Environmental Remediation and Response (DERR) can provide more details.

Also, you must comply with fire code regulations for all USTs. Contact your local fire department for more information.

Regulated Underground Storage Tanks

All USTs with a capacity greater than 1,100 gallons (in single or multiple-tank arrangements) are covered by state and federal environmental regulations.

These tanks must be registered with DERR, be monitored for leaks at least monthly with a DERR-approved leak detection method, and comply with approved corrosion protection requirements for tanks and piping. USTs also require a minimum set of basic requirements for spill and tank overflow prevention.

MONITORING OF ALL TANKS, PIPES AND VALVES

Regular monitoring of fuel levels in your storage tanks helps detect leaks quickly. At a minimum, compare the volume of tank contents regularly with product delivery and withdrawal records to help detect leaks before major problems develop.

Remember most leaks result from piping failures. You can easily spot leaks in an AST by noting a fuel spot on the tank or dead vegetation on the ground below the tank.



TAKE ACTION!

Check your pipes. A leak as small as one drop per second can release 400 gallons of fuel into the environment in one year.

Although unregulated USTs (less than 1,100 gallons) are not required to be monitored for leaks, it is still a very good idea to check for leaks at least once a year. If your tank is more than 15 years old, or if you don't know its age, make a special effort immediately to determine whether leaks exist or possible danger spots. Regulated USTs have monitoring requirements (see above) and must be fitted with leak detection systems.

Testing for Leaks in Tanks With a Capacity of 1,100 Gallons or Less

You will need a gauging stick with a scale to one-eighth inch increments, a pencil, and a notebook.

1. Measure and record the depth of product at the beginning and end of a pre-defined time period (e.g. 24 hours) during which no fuel is being used.
2. Perform test several times to improve accuracy of the test.
3. If product level changes over the defined time period, check your tank for leaks.

If You Find a Leak

If you suspect a leak (due to suspicious smells, fumes, or loss of product), call the local fire department immediately. They can check your tank and piping to make sure it's safe. Remember, leaking tanks not only endanger our waters but create a serious risk of explosion.

Fuel leaks of less than 25 gallons that are cleaned up within 24 hours do not have to be reported to the DERR.

For all other leaks or spills, whether from an AST, a UST, or a vehicle-mounted tank, state law requires you notify the DERR UST Program within 24 hours of its discovery. DERR has a 24 hour hotline (801-536-4123) to report spills and leaks. Owners or operators of storage tanks are required to follow the instructions they receive and must take whatever actions are necessary to remedy the problem.

Closing Tanks

~~Tanks no longer in use can cause problems for owners and operators many years later. They continue to corrode and, if they still contain gas or oil, will likely contaminate groundwater. Determine the location of any unused tanks on your property. Proper closure procedures must be followed to prevent groundwater contamination, fire, explosion, or other health and safety problems. Always notify the fire department before removing a tank to ensure it is safe to remove it, and to follow fire protection codes.~~

Any regulated underground tank which has not been used for 12 months or more must be removed from the property and properly disposed of in accordance with fire code requirements and DERR regulations. This requires pre-approval by DERR and the fire department, a site assessment, and supervision by a certified tank contractor.

CONTACTS AND REFERENCES

FUEL SPILLS AND INCIDENTS

Spill Hotline: Division of Environmental Response and Remediation: (801) 536-4123

National Response Center: Call toll free (800) 424-8802

Local fire department (check county or city phone book)

EPA Oil Spill Program Information Line: Call toll free (801) 536-4123

Report oil spills online at: <http://www.epa.gov/oilspill/oilhow.htm>

ABOVEGROUND STORAGE TANK REGULATIONS

Contact your fire marshal through your local fire department.

Environmental Protection Agency: (800) 424-9346.

REGULATIONS FOR TANKS WITHIN CONTAMINATION RANGE OF COMMUNITY WATER SUPPLIES

Utah Division of Drinking Water: Source Protection Program: (801) 536-4200

or http://drinkingwater.utah.gov/source_protection_intro.htm

UNDERGROUND STORAGE TANK

Division of Environmental Response and Remediation
UST Compliance Section: (801)536-4100
or on the web at:
<http://www.undergroundtanks.utah.gov/>
Environmental Response Homepage at
<http://www.environmentalresponse.utah.gov/>
Local contact information at
http://www.undergroundtanks.utah.gov/ust_contacts.htm

EPA Office of Underground Storage Tanks Most
Frequently Asked Questions on the web at:
<http://www.epa.gov/oust/faqs/index.htm>

MORE READING:

UNDERGROUND STORAGE TANK REGULATIONS

Keeping Utah Clean and Healthy, Fact sheet about DERR
[http://www.eq.state.ut.us/offices/ppa/news/fact%20sheets/
DERR.htm](http://www.eq.state.ut.us/offices/ppa/news/fact%20sheets/DERR.htm)

Overview of Utah's rules, forms and program for USTs
<http://undergroundtanks.utah.gov/ustcomp/utustsum.htm>

*Federal Regulations Regarding Underground Storage Tanks
(40 CFR, part 280 and 281)*
<http://www.epa.gov/oust/fedlaws/cfr.htm>

*Utah Administration Rules Concerning Underground Storage
Tanks*
[http://www.undergroundtanks.utah.gov/docs/R31120112_
new_final.pdf](http://www.undergroundtanks.utah.gov/docs/R31120112_
new_final.pdf)

OTHER EDUCATIONAL MATERIALS ABOUT OIL SPILLS

EPA Mid-Atlantic Oil Program at
<http://www.epa.gov/oilspill/eduhome.htm>

Understanding Oil Spills and Oil Spill Response at
[http://www.epa.gov/osweroc1/content/learning/pdfbook.h
tm](http://www.epa.gov/osweroc1/content/learning/pdfbook.h
tm)

OTHER QUESTIONS?

Contact USU Extension's Water Quality Program:
(435) 797-2580.
or on the web at <http://extension.usu.edu/waterquality/>

PROJECT COORDINATED BY:

Nancy Mesner, Utah State University. Written by Leonard Massie, Department of Agricultural Engineering, University of Wisconsin-Madison, and University of Wisconsin Extension, Cooperative Extension. Adapted for use in Utah by an interagency team from materials prepared by Montana State University Extension Service, Kansas State University and Purdue University Extension Service. The Farmstead Assessment System is a cooperative project of Utah State University Extension, Utah Department of Agriculture and Food, Utah Department of Environmental Quality, Utah Farm Bureau, Utah Association of Conservation Districts, and Natural Resources Conservation Service.

UTAH FARM •A•SYST ADVISORY COMMITTEE AND REVIEW TEAM:

Howard Deer, John Harrison, Robert W. Hill, Rich Koenig, Nancy Mesner, - Utah State University Extension; Kerry Goodrich - Natural Resources Conservation Service; Mark T. Novak - Division of Water Quality, Utah Department of Environmental Quality; Bob Lowe - Division of Drinking Water, Utah Department of Environmental Quality; Mark Quilter - Utah Department of Agriculture and Food; Mark M. Petersen - Utah Farm Bureau; Utah Association of Conservation Districts.

WE ACKNOWLEDGE THE CONTRIBUTIONS MADE BY THE FOLLOWING INDIVIDUALS:

Mike Allred, Thomas E. Bingham, Kitt Farrell-Poe, Roy Gunnell, Krista Kuester, Dean Maxwell, Stephen E. Poe, W.D. Robinson, Jay Roundy, Adam Siggler and Kyle Peterson Koyle.

Funding provided by USDA CSREES Water Quality Initiative Grant 99-EWQI-1-0542.

MAY 2005, PEER REVIEWED

GLOSSARY

These definitions may help clarify some terms used in this Fact Sheet and may also help you make more accurate assessments when completing the Utah Farmstead Assessment for Ground Water and Surface Water Protection Survey 4 (Landowner's Survey: What's the Risk to your water from fuels?)

CERTIFIED TANK CONTRACTOR: A person certified by the state to install and repair fuel storage tanks. Contact Utah Division of Environmental Response and Remediation for a list of names.

CORROSION: Deterioration of a metallic material ("rust") due to a reaction with its environment.

CORROSION PROTECTION: Steel tanks can be protected by coating them with a corrosion-resistant coating combined with "cathodic" protection. Steel underground tanks can also be protected from corrosion if they are bonded to a thick layer of non-corrosive material, such as fiberglass-reinforced plastic. Also, the corrosion problem can be entirely avoided by using tanks and piping made completely of non-corrosive material, such as fiberglass.

SECONDARY CONTAINMENT: A system such as a sealed basin and dike that will catch and hold the contents of a tank if it leaks or ruptures.

SPILL AND OVERFILL PROTECTION: Spill protection usually consists of a catch basin for collecting spills when the tank is filled. Overfill protection is a warning or prevention of an overfill, such as an automatic shutoff or buzzer. These precautions can prevent a number of small releases over a very long period of time from polluting ground water.

Preventing Leaks and Spills at Service Stations

A Guide for Facilities

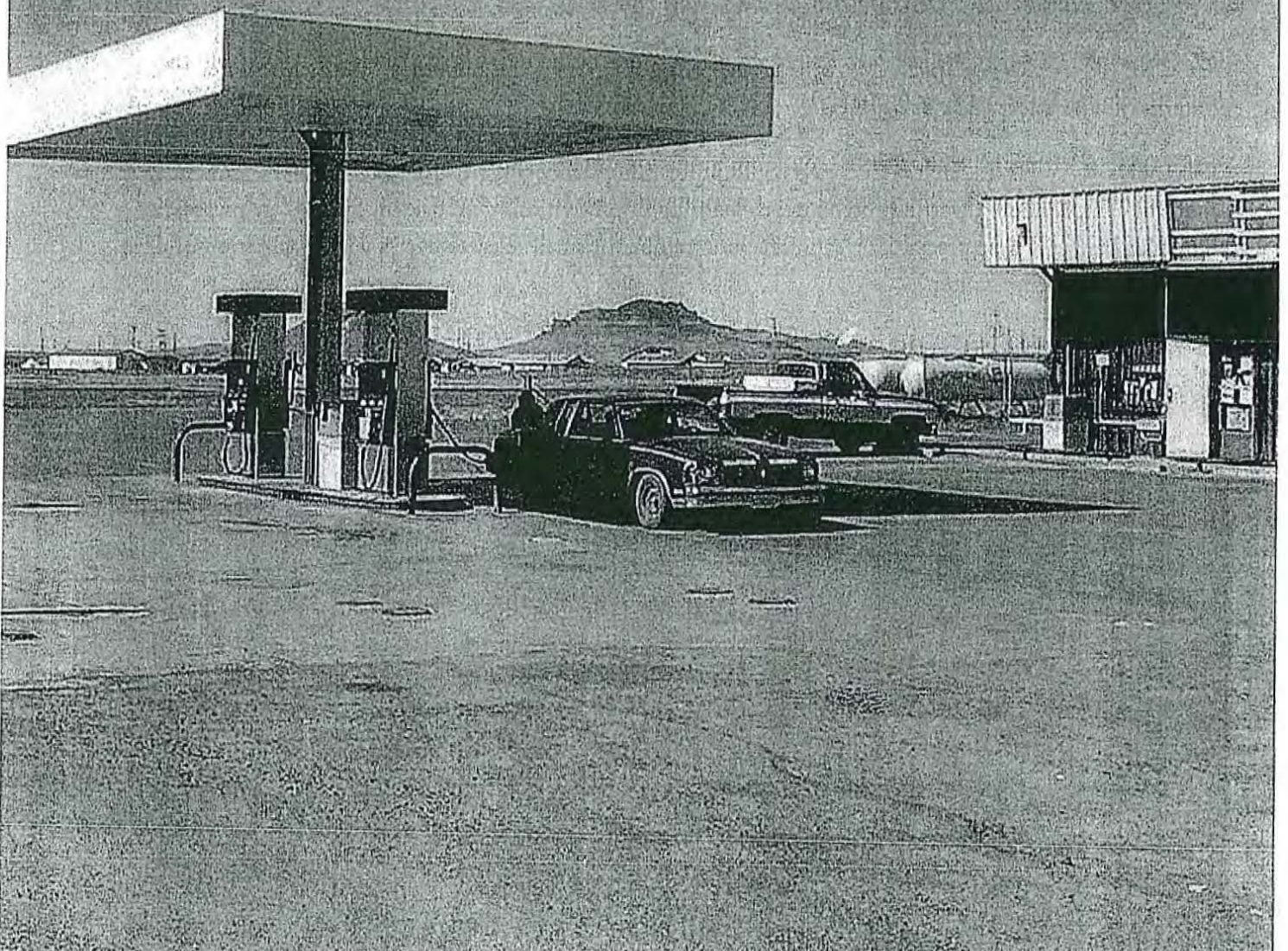

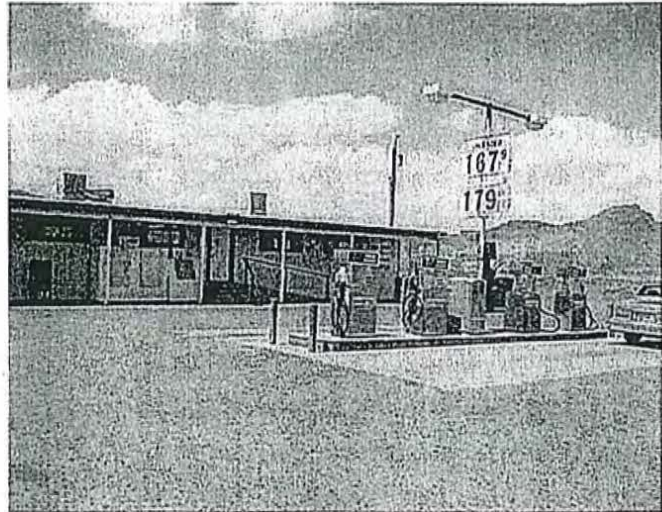
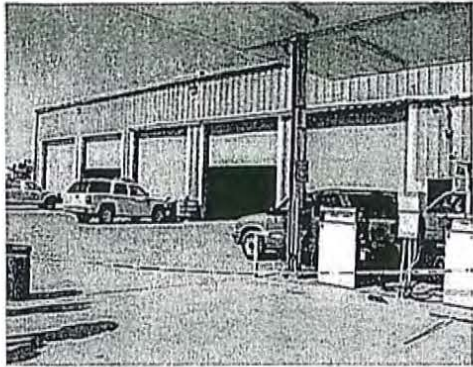

Contents

Underground Storage Tanks.....	2
Aboveground Storage Tanks.....	5
Used Oil.....	8
Class V Motor Vehicle Waste Disposal Wells.....	11
Air Conditioning Units.....	14
Emergency Spill Response.....	17

Introduction

In recent years, leaking fuel tanks and spills at gas stations have contaminated drinking water sources for nearby communities, and have become costly for owners to clean up. This handbook provides guidance for owners and operators of gas stations on how to protect the environment, comply with federal environmental regulations, and save money by preventing the need for costly cleanups and payment of legal penalties. This guide is especially useful for facilities on tribal lands and in U.S. territories, where federal regulations are sometimes the only environmental rules in effect.



This handbook highlights five major areas of environmental management at gas stations: underground storage tanks, aboveground storage tanks, used oil, vehicle waste disposal wells, air conditioning units, and emergency spill response. Each section includes a brief introduction, suggests good management practices, provides a checklist for compliance, and lists EPA contacts for additional assistance.

If your facility does auto repair, you may also be interested in *The Pollution Prevention Toolkit: Best Environmental Practices for Auto Repair*. This is a series of fact sheets plus a video, available free of charge from EPA, showing the best ways for auto repair shops and fleet maintenance facilities to prevent pollution. To order the free package, call 1-800-490-9198. More information can be found at: www.epa.gov/region09/p2/autofleet

This publication is intended to provide guidance on the federal regulations and should not be used to meet all owner/operator responsibilities. It is not a substitute for U.S. Environmental Protection Agency regulations, nor is it a regulation itself. It does not impose legally binding requirements. It does provide information on compliance with important federal requirements applicable at gasoline service stations. For a comprehensive understanding, please refer to the Code of Federal Regulations, and note that local regulations may be more stringent than the federal regulations. Check with your local regulatory authority. If you are not sure who your regulatory authority is, you can find out by calling EPA's toll free hotline at 1-800-424-9346.

EPA does not endorse any companies or names that are mentioned or shown in this workbook or poster. Many of these pictures were taken on the Navajo Nation.

EXHIBIT C



Underground Storage Tanks



Upper left: Installation of new USTs.

Upper right: A UST inspection in progress.

Lower right: Removal of leaking UST and contaminated soil.



An underground storage tank (UST) is a tank and any connected underground piping that has at least 10 percent of its combined volume underground. **Federal regulations require** owners/operators of USTs to have proper **corrosion protection, spill and overflow protection, a leak detection system** and **financial assurance** for liability.

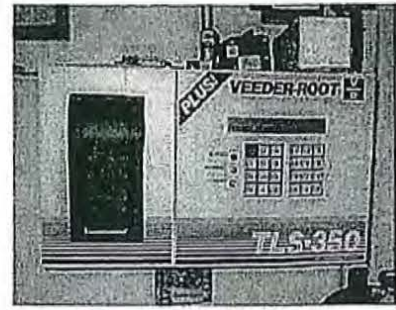
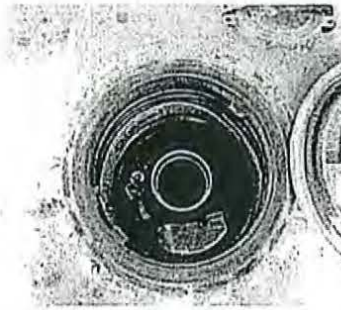

Upper left: Keep your sumps empty and clean.

Upper center: Keep your spill buckets empty and clean.

Upper right: Test your Automatic Tank Gauge (ATG) to make sure it is calibrated and working properly.

Lower left: Organize and maintain your records and documents.

Lower right: Example of overfill protection and automatic shutoff device used during deliveries.

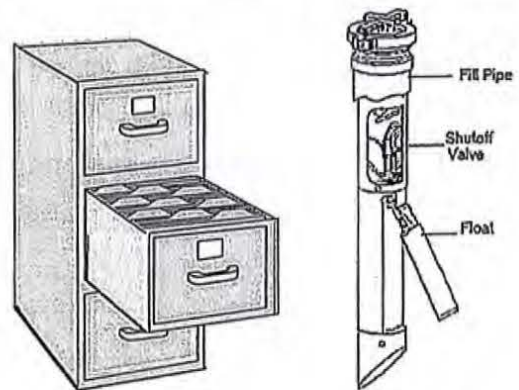

Good Management Practices:

- Organize and maintain necessary documents at your facility that include the following records:
 - Financial assurance
 - Valid tank and piping leak detection results
 - Repairs and upgrades to tanks and piping system
 - Installation of overfill protection (such as flapper valve, ball float, or high level alarm)
 - Installation of corrosion-protected tanks and piping, if applicable
 - Records of cathodic protection testing, if applicable
 - Records of internal inspection for steel tanks, if applicable
- Keep spill buckets free of liquids and dirt. Check to see if your spill bucket is leak-free and operational.
- Check all metal piping in contact with soil and water for corrosion protection.
- Check dispenser area and piping sumps for leaks. If any water or gasoline is present, remove it and dispose of it properly. Make any necessary repairs.
- Test your ATG system, if installed, to make sure it is properly calibrated and working.
- On-site staff should know how to operate the ATG and emergency shutoff valve.
- Facility should have a tank specifications chart available during deliveries.

Checklist For Compliance

The following checklist will help you manage your USTs. Always contact your local authority for further compliance.

- Submit a signed Notification Form 7530-1 for Underground Storage Tanks to EPA and tribal/local environmental agencies (where applicable) 30 days prior to a new tank installation or changes in tanks or piping.
- You must have passing leak detection results for your tanks at least every 30 days. Common leak detection methods for tanks include automatic tank gauging, statistical inventory reconciliation (SIR), and inventory control with tank tightness testing. Maintain monthly records for the previous 12 months.
- You must also have leak detection results for your piping. For pressurized piping systems, this includes an annual operation test of the automatic line leak detector and either an annual line tightness test or leak detection tests at least every 30 days. Remember to keep these test results as records.
- Demonstrate that each tank has spill and overfill protection that is in good working order.
- All metallic components (such as tanks, piping, joints) in contact with soil must

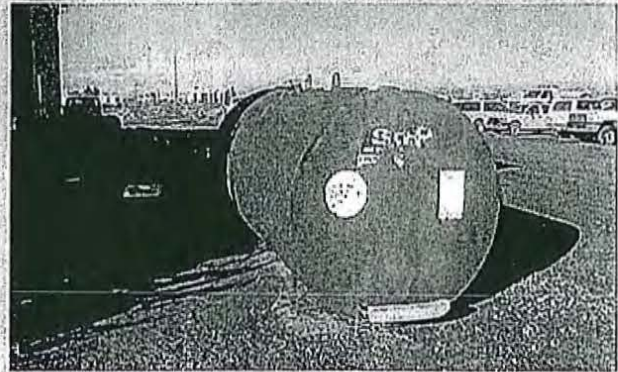

Steel tank with sacrificial anode (bottom) as corrosion protection.

have corrosion protection. Remember to keep records of cathodic protection testing and internal lining inspections (if you use these methods for corrosion protection).

- You must have financial assurance to cover cleanup costs of potential soil and groundwater contamination.
- During temporary or permanent closure of USTs, tanks must follow proper closure requirements. Notify EPA and tribal/local authorities at least 30 days in advance if you plan on permanently closing your tanks.

For general UST information refer to: www.epa.gov/oust or contact EPA's Call Center at 1-800-424-9346. You may also contact the EPA Region 9 UST program staff at 415-972-3367.



Aboveground Storage Tanks

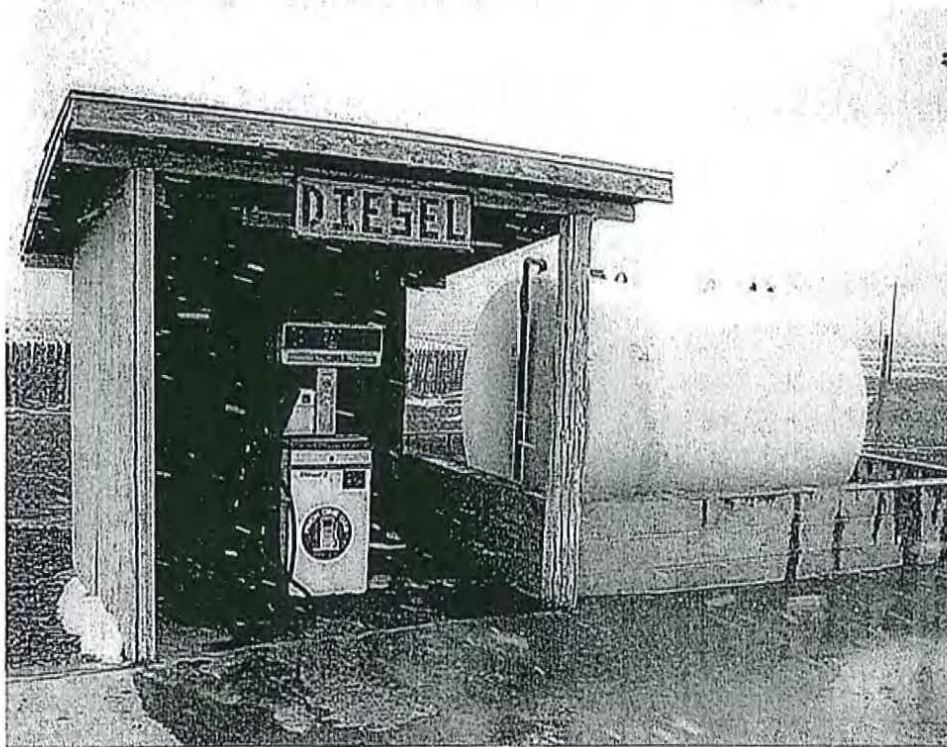

Another common method for storing fuels at service stations is the use of aboveground storage tanks (ASTs). Any AST holding petroleum products or used oil may be regulated under the Clean Water Act because releases can contaminate surface waters. Single tanks with an aboveground storage capacity of more than 1,320 gallons or combined aggregate storage in containers of 55 gallons or greater totaling more than 1,320 gallons are subject to the federal Oil Spill Prevention, Control and Countermeasure (SPCC) regulations.

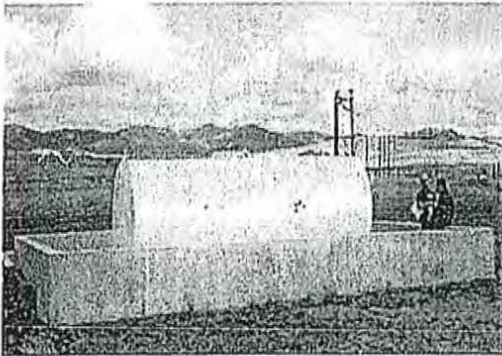

Upper left: Good example of secondary containment.

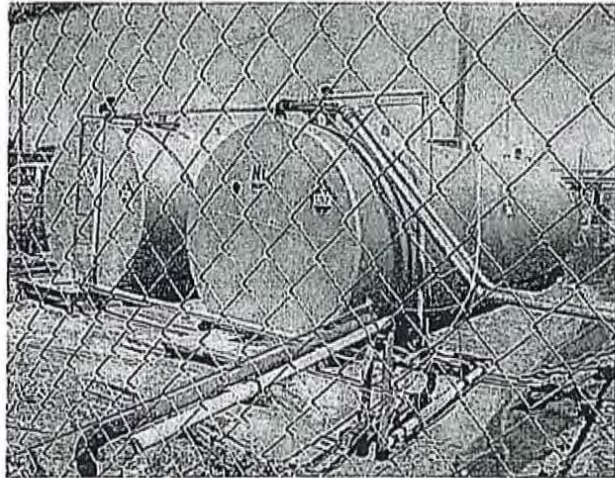

Upper right: Good example of security fencing.

Lower right: Routinely check tank, valves, hoses, and piping for any leaks.



Good Management Practices

- Provide corrosion protection for ASTs and any buried piping. Options include elevating tanks, resting tanks on continuous concrete slabs, installing double-walled tanks, or cathodically protecting the tanks and piping.
- To prevent rainwater from filling containment areas, you may need to cover the tank with a roof structure.
- To prevent evaporative losses and moisture condensation, you may want to paint tanks a reflective color, as shown in the above photos.
- Regularly check the dispenser hoses and piping for any leaks (a common problem).
- On-site staff should be trained to handle emergencies, such as leaks or explosions.

Checklist For Compliance

The following checklist will help you manage your aboveground storage tanks. Always contact your local authority for further compliance.

- Develop and implement a Spill Prevention, Control and Countermeasure (SPCC) Plan** if the combined capacity of your ASTs is greater than 1,320 gallons. The SPCC Plan must be certified by a Professional Engineer.
- All ASTs should have a **secondary means of containment** capable of holding 100% of the largest tank capacity plus sufficient room to hold stormwater/rain water. Options include either having double-walled tanks; berms, dikes, or vaults; or leak-proof retention ponds or holding basins.
- If a loading "rack" is present, tank loading and unloading procedures must have some form of secondary containment sufficient to account for the largest compartment of the delivery truck. If there is no "rack" present, there must be general drainage control to prevent a release during delivery.
- Buried piping must be protectively wrapped and/or coated to prevent corrosion, and periodically tested for structural integrity.
- Routinely monitor ASTs to ensure they are not leaking. Areas to inspect include tank foundations, connections, coatings, tank walls, and piping systems. The new SPCC rule requires combining tank inspection with integrity testing based on industry standards.



Wrong: This AST has inadequate secondary containment, and no way to prevent vehicles from hitting it.

- Control drainage from diked containment areas with manually controlled valves.** Any discharge should be inspected for petroleum and chemicals prior to disposal.
- Provide adequate security** including fencing and lighting. Tank valves must be closed and locked when not operating. Starter controls must be closed and locked when not operating, and accessible only to authorized personnel.
- Oil handling employees must be trained** in proper handling of oil and applicable pollution control laws, rules and regulations. Training records must be maintained for at least three years.

For general AST and SPCC information refer to: www.epa.gov/oilspill or contact EPA's Call Center at 1-800-424-9346. You may also refer to the EPA Region 9 Web site: www.epa.gov/region09/waste/sfund/oilpp



Used Oil

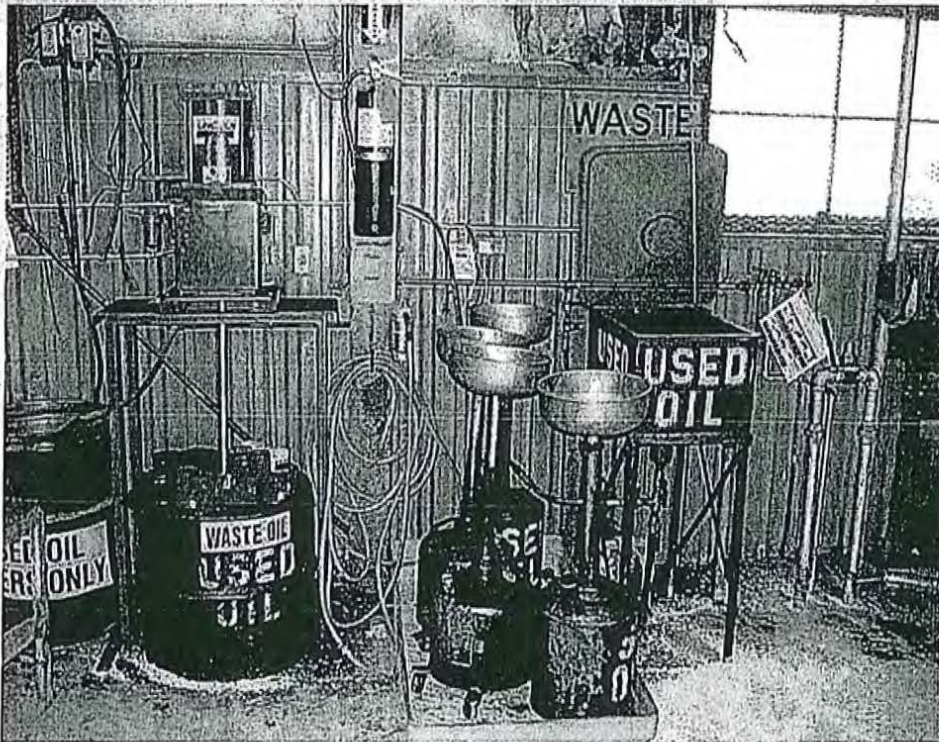

Containers for used oil should be clearly labeled, as shown here. Extra care should be taken to avoid spillage shown by floor stains.

If your facility changes oil on vehicles or accepts used oil from your community, you must follow the federal standards for the management of used oil. These standards require your shop to comply with basic storage requirements. Used oil should be stored only in containers and tanks that are in **good condition** (free of any visible leaks, structural damage, or deterioration). Containers, aboveground tanks, and fill pipes that transfer used oil into underground storage tanks all need to be clearly marked with the words **"USED OIL"** to prevent mixing of used oil with other materials.

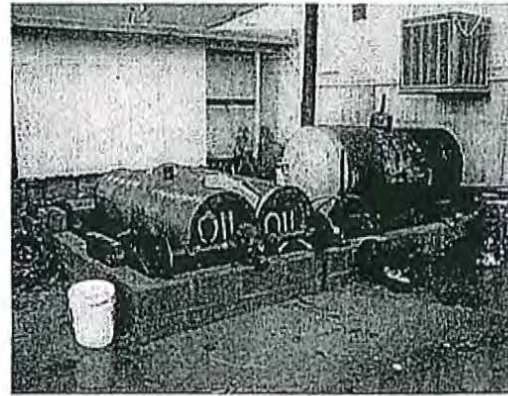
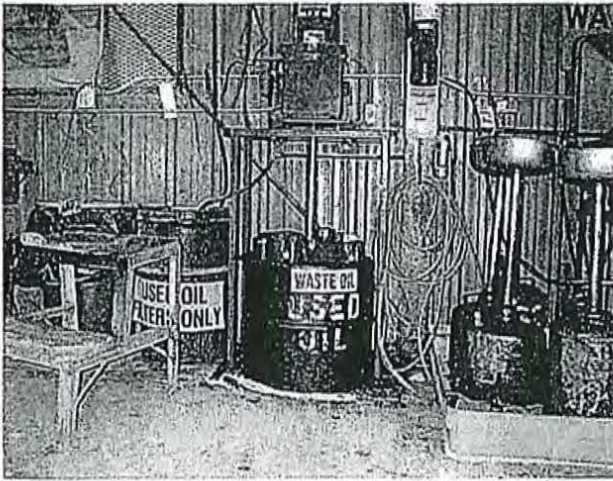

Containers must be in good condition and clearly labeled.

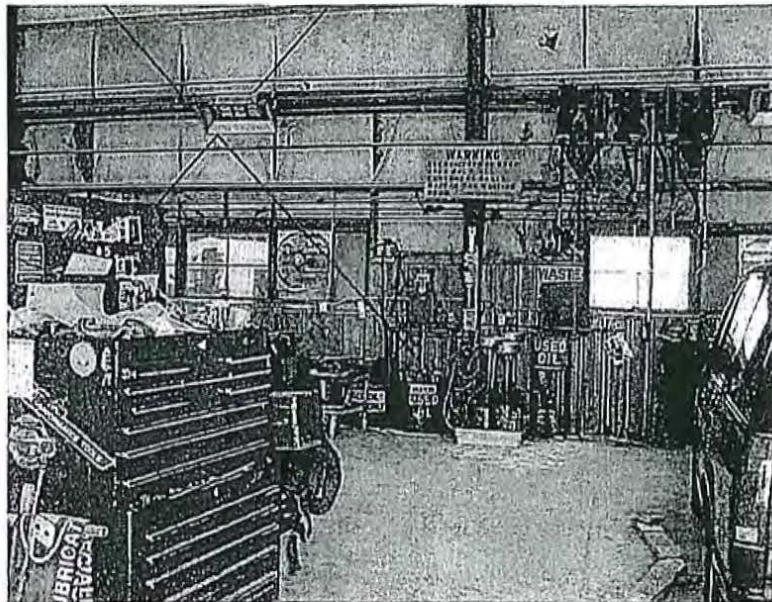

Good Management Practices

- When changing oil, set up equipment—such as a drip table or screen table with a used oil collection bucket—to collect oil dripping off parts. Place drip pans underneath vehicles that leak fluids.
- Used oil filters should be drained, crushed, and stored in a container that is labeled “Used Oil Filters.” Most oil filters can be recycled. This process exempts filters from being considered hazardous waste.
- If your facility is storing used oil destined for recycling in underground storage tanks (USTs), you must follow UST regulations. Refer to the UST section, p 2–4.

✓ Checklist For Compliance

The following checklist will help you manage your used oil. Always contact your local authority for further compliance.

- Keep used oil storage tanks and containers in good condition; label tanks and containers with the words "USED OIL."
- When changing oil, set up equipment, such as a drip table or screen table, to collect oil dripping off parts.
- Oil filters should be drained (for 24 hours) and crushed prior to recycling or disposal. It is good practice to label storage containers as "USED OIL FILTERS."
- Immediately clean up any oil spills or leaks to the environment.
- Do not mix used oil with hazardous waste (such as gasoline or solvents), or else it will have to be managed as hazardous waste, which is more costly and cannot be recycled. Used oil should be separated from other wastes and stored in leak-free containers labeled "USED OIL."
- Used oil generated by a shop may be burned on site in a commercial space heater. Also, used oil may be sent to a burner for energy recovery.

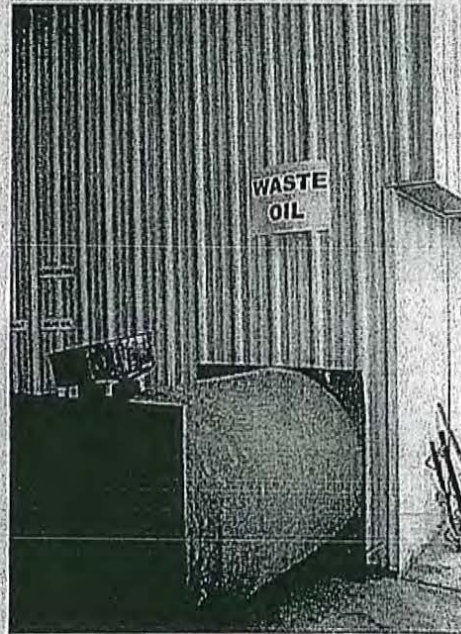

Contact local authorities to determine requirements and obtain necessary permits.

- If shipping used oil off site to be burned, you must obtain an EPA identification number by calling the EPA Region 9 RCRA Notification Switchboard at 415-495-8895.

Contact EPA's Call Center toll-free at 1-800-424-9346 for additional information about used oil management



Class V Motor Vehicle Waste Disposal Wells



Floor drains in service bays might lead to a Class V (Five) Motor Vehicle Waste Disposal Well.

Your facility may be using a Class V Motor Vehicle Waste Disposal Well if there is a floor drain on site. Floor drains that are not connected to a sewer line are considered Class V Motor Vehicle Waste Disposal Wells if used to receive fluids from vehicle repair or maintenance activities (this includes drainage from car wash stations). In order to protect drinking water, **federal requirements prohibit using existing motor vehicle waste disposal wells, unless the owner and operator seeks a waiver and obtains a permit** from EPA and local authorities, if applicable. Constructing new motor vehicle waste disposal wells is prohibited nationwide, due to the risk of polluting groundwater.

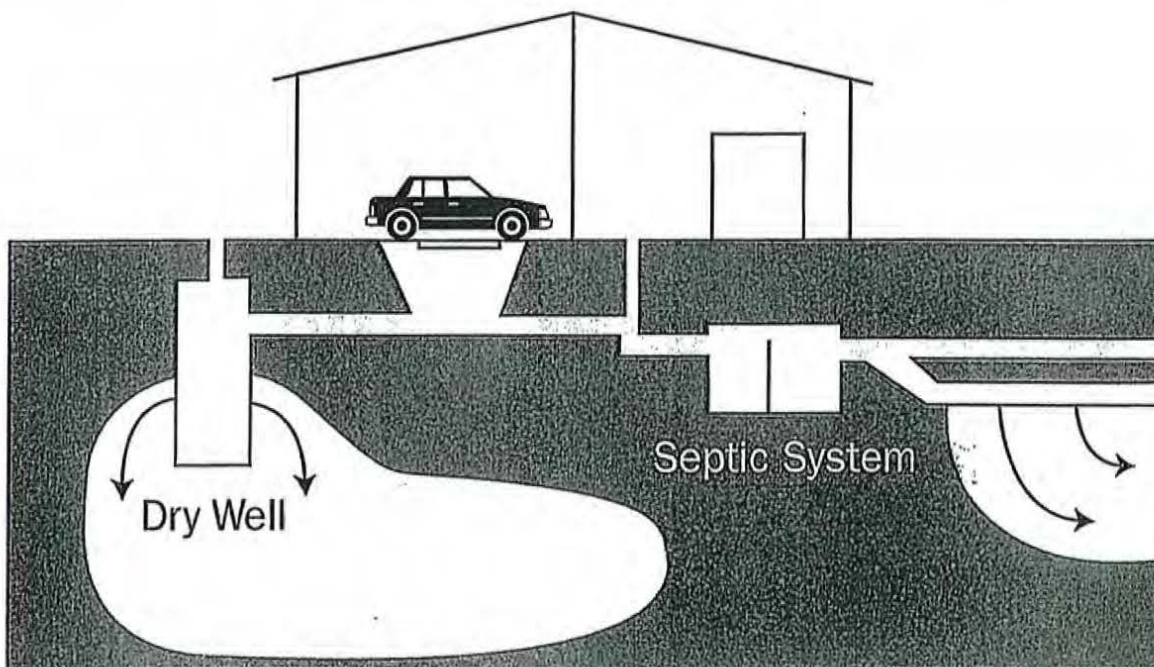

Use of dry wells should be avoided, due to the risk of contaminating groundwater.

Good Management Practices

- Facility managers should know if floor drains lead to a municipal sewer line, to a surface discharge, to a leakproof sump, or to a shallow injection well. Facility managers should obtain the diagrams for all the existing underground construction at their facility to track the transport of these fluids.
- Facility managers should know all sources of fluids that flow onto or originate from their property, including rain, snow, fuel, motor vehicle fluids, and wastewater from bathrooms and sinks.
- “Dry shop” practices minimize the risk of polluting water. For more information, go to: www.epa.gov/region09/p2/autofleet/ or www.ccar-greenlink.org/
- Facility managers should use best management practices, such as dry shop technologies, waste minimization, and employee education. These activities are described more fully in the EPA publication, *Small Entity Compliance Guide: How the New Motor Vehicle Waste Disposal Well Rule Affects Your Business*. This can be found at www.epa.gov/sbrefa4u/documents/2778secg.pdf

✓ Checklist For Compliance

The following checklist will help you manage your motor vehicle waste disposal wells.

Always contact your local authority for further compliance.

- All owners and operators of Class V motor vehicle waste disposal wells must provide to the EPA Underground Injection (UIC) program the following inventory information:
 - Facility name and location
 - Legal contact
 - Nature of injection activity
 - Operating status of injection well

- Class V wells must not endanger or contaminate any underground source of drinking water.

- Establishment of new motor vehicle waste disposal wells is prohibited.

- Use of existing motor vehicle waste disposal wells is banned unless a permit is obtained.

- Owners and operators must notify the UIC Program Director at the applicable regulatory agency at least 30 days before closing an existing motor vehicle waste disposal well.



For more information:

Contact the Safe Drinking Water Hotline at 1-800-426-4791. You can also get well-specific fact sheets and other information on Class V injection wells, including information on the Class V Rule from the EPA Web site: www.epa.gov/safewater/uic/classv.html



Air Conditioning Units



When air conditioning units are repaired, they must be serviced by an EPA-certified technician.

If your facility services motor vehicle air conditioning units, you may be subject to Clean Air Act regulations. Many motor vehicle air conditioners (MVACs) contain refrigerants with chlorofluorocarbons (CFCs) and similar chemicals, which damage the Earth's protective stratospheric ozone layer if released to the air. **Regulations require that refrigerants be removed from motor vehicles using U.S. EPA-registered equipment. Technicians must be certified** to service air conditioning units. You must sell the refrigerant you collect to a reclamation facility so that it can be purified for reuse.

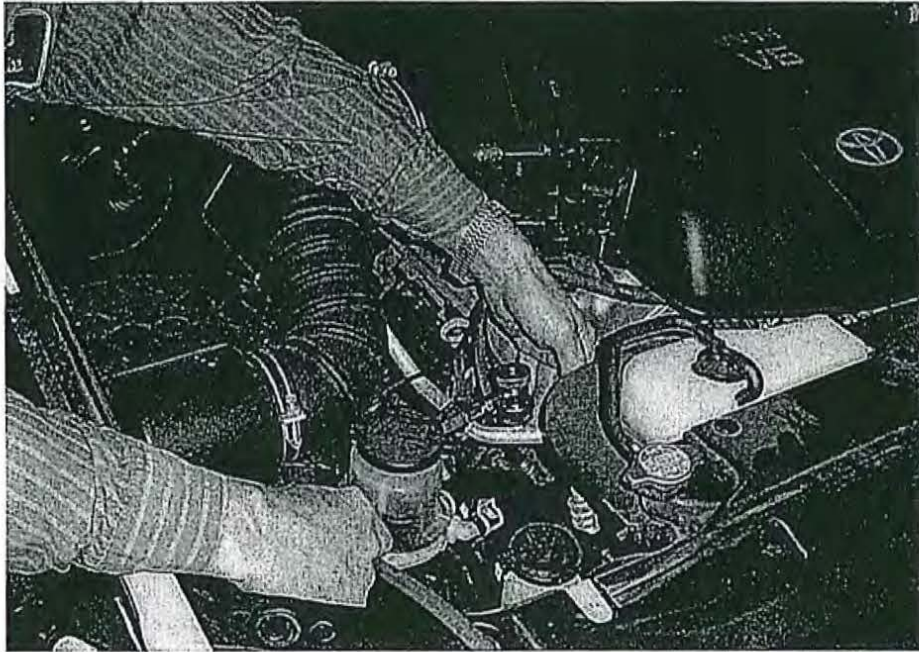

Upper: Follow accepted procedures for changing fittings and labeling refrigerants in AC units that have been retrofitted.

Lower: Facilities must use EPA-approved recycling equipment.



Good Management Practices

- Leaky air conditioners should be repaired rather than just “topped off” with additional refrigerant. Such repairs prolong system life, reduce emissions, and conserve existing supplies of CFCs, which can no longer be legally manufactured or imported.

Checklist For Compliance

The following checklist will help you manage motor vehicle air conditioning units. Always contact your local authority for further compliance.

- It is illegal to vent and release CFCs, HCFCs, HFCs, and any R-12 replacement to the atmosphere. These chemicals must be recovered during servicing.
- If performing maintenance on motor vehicle air conditioning equipment, you must have documentation proving that you and your facility are certified by an EPA-approved testing organization.
- Recovery equipment must be registered with EPA.
- Recover and/or recycle refrigerants during the servicing and disposal of motor vehicle air conditioners and refrigeration equipment.
- After removal and collection, refrigerant must be sold to a reclamation facility so that it can be purified, unless your facility has the capacity to recycle the refrigerant back into the original vehicle or into another serviced vehicle.
- If refrigerants are recovered and sent to a reclamation facility, the name and address of that facility must be kept on file.
- In addition, when servicing units that use alternative non-ozone-depleting substances, you are still required to use certified equipment and be a certified technician.

Additional information is available through the toll-free Stratospheric Ozone Information Hotline: 1-800-296-1996. You may also go to www.epa.gov/ozone

Emergency Spill Response

For any explosions or major petroleum spills, immediately contact the National Response Center at 800-424-8802.

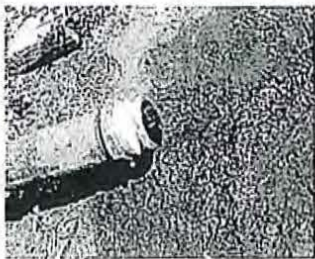

If any release from an underground storage tank (UST) or aboveground storage tank (AST) is suspected, the owner or operator must report the release within 24 hours. Short-term actions should also be taken immediately to stop the release and ensure that there is no threat to public safety, human health, or the environment.

Short-Term Actions

- Take immediate action to safely stop and contain the release.
- Report the release to the National Response Center, EPA and your local regulatory authority within 24 hours.
- Make sure the release poses no immediate hazard to human health and safety by removing explosive vapors and fire hazards. Your fire department should be able to help or advise you with this task. You must also make sure you handle and dispose of contaminated soil properly so that it poses no hazard (for example, from vapors or direct contact).
- Remove petroleum from the UST or AST system to prevent further release into the environment.
- Find out how far the petroleum has moved and begin to recover the leaked petroleum (such as product floating on the water table). Report your progress and any information you have collected to EPA and your local regulatory authority no later than 20 days after confirming a release.
- Investigate if the release has impacted the soil and subsurface environment.

This investigation must determine the extent of contamination both in soils and groundwater. You must report to EPA and your local regulatory authority what you have learned from an investigation of your site according to the schedule established by the regulatory authority. At the same time, you must also submit a Corrective Action Plan explaining how you plan to clean up the site.

National Response Center: 800-424-8802

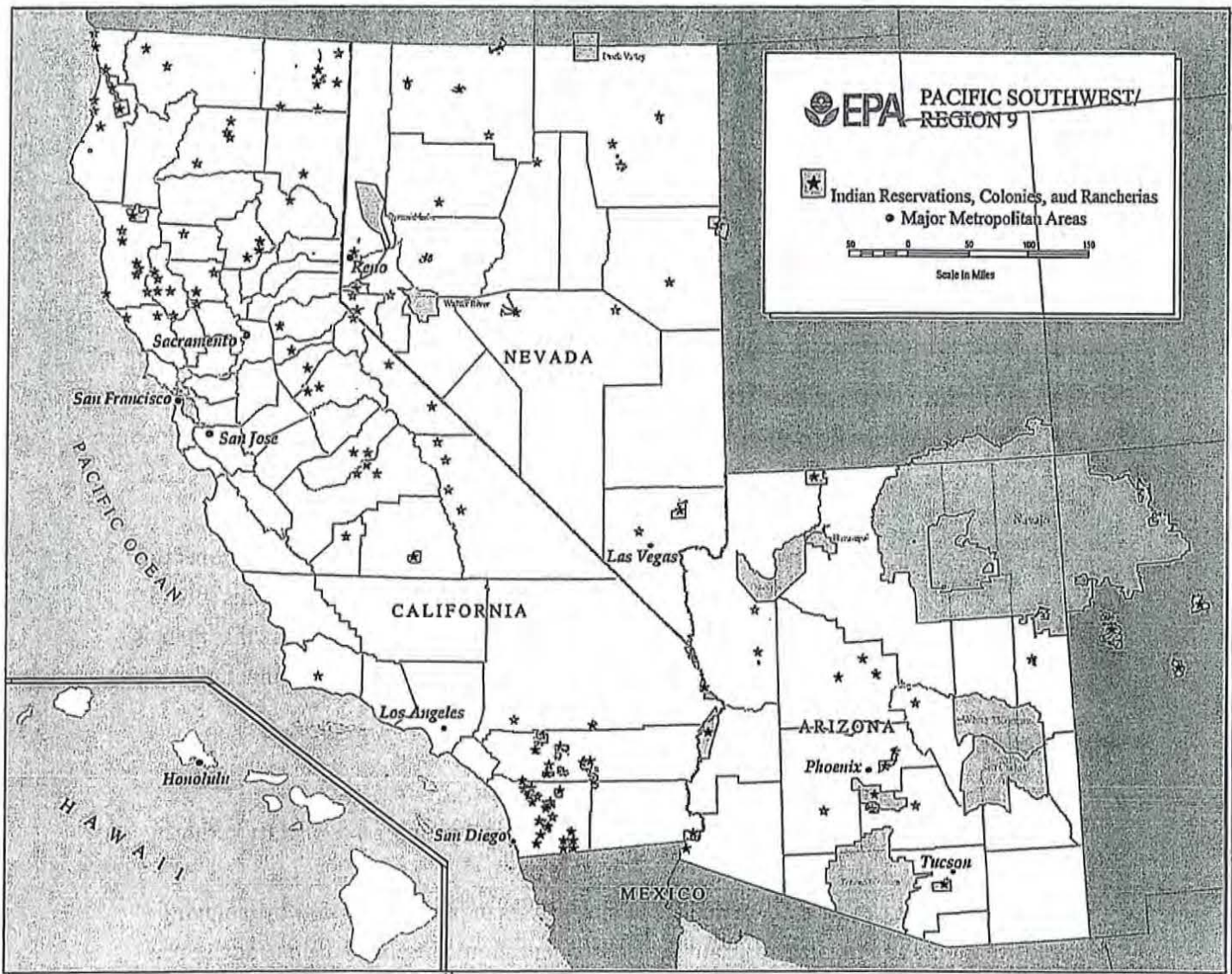

EPA's Pacific Southwest Region includes the states of Arizona, California, Hawaii and Nevada; 147 tribal nations and communities; and Pacific islands that are U.S. territories or to which the U.S. has ongoing commitments. Map shows boundaries of states, counties, and tribal lands.

U.S. Environmental Protection Agency Pacific Southwest/Region 9 Contacts

U.S. EPA Pacific Southwest/Region 9
75 Hawthorne St.
San Francisco, CA 94105

Phone inquiries: 415-947-8000 or 866-EPA-WEST (toll free)

Email inquiries: r9.info@epa.gov

EPA Web site: www.epa.gov

For Pacific Southwest Issues: www.epa.gov/region09

EXHIBIT D



Amy Anders <gvcenter2012@gmail.com>

Re: Alternate Development Proposal Green Valley Convenience Center-Arco am/pm BCE #15593

1 message

Amy Anders <gvcenter2012@gmail.com>

Mon, Nov 4, 2013 at 7:06 AM

To: Dan Goalwin <dgoalwin@barghausen.com>

Cc: Darren Bobrowsky <bobrowsky@gmail.com>, "strauchco@sbcglobal.net" <strauchco@sbcglobal.net>, "craig Sandberg (craig@sandberglaw.net)" <craig@sandberglaw.net>, "tom.dougherty@edcgov.us" <tom.dougherty@edcgov.us>, "roger.trout@edcgov.us" <roger.trout@edcgov.us>, "peter.maurer@edcgov.us" <peter.maurer@edcgov.us>, "Ken Anderson (KAnderson@kdanderson.com)" <KAnderson@kdanderson.com>, "paulb@bacnoise.com" <paulb@bacnoise.com>, Jonathan Flecker <JFlecker@kdanderson.com>, "Jeffery Little (Jeffery.Little@SycamoreEnv.com)" <Jeffery.Little@sycamoreenv.com>, "Charles Hughes (Charles.Hughes@SycamoreEnv.com)" <Charles.Hughes@sycamoreenv.com>, File <File@barghausen.com>, Eric Ramsing <eramsing@barghausen.com>

Dan and Marc,

This looks like good progress; however, you sent this information via email at 7 p.m. Friday night. Clearly, I have not had time to review the proposed changes with my team, and I am unable to meet your deadline today, Monday, 10 a.m.

Amy L. Anders

On Fri, Nov 1, 2013 at 6:52 PM, Dan Goalwin <dgoalwin@barghausen.com> wrote:

Amy and Darren, please find attached exhibits that have been prepared for your consideration. These exhibits represent the three changes to the project that you indicated would allow you to set aside appeal of the planning commission decision to the board of supervisors. These were:

1. In lieu of a tapered entry into the driveway as approved by the Planning Commission, a right-turn drop lane was to be extended to the large utility vaults located roughly near the intersection. It was understood that we need to accommodate from a median (3' per David after confirmation), a 14 foot lane adjacent, a 12 foot through lane a 4 foot bike lane and a 10 foot drop lane per David Spiegelberg's comments at our meeting.
2. Visually Screen the stacking lanes and the building from the south and the south east with redwood trees at the site level and utilize taller trellis screens at the top of the retaining wall. It was communicated at the meeting that you felt the big trees would also provide for sound attenuation. This is not the case as is explained by our Acoustical consultant in the attached letter for BAC.
3. Change the roof material to a tile material to better blend with the Promontory roofing which is a blend of flat and barrel tile roofs.

The attached exhibits graphically represent these changes. The following solutions are presented:

1. The site plan depicts the lane channelization as discussed above. The existing roadway accommodates the channelization with the exception of the new 10 foot turn lane. The current ROW does not support the addition of this lane and the sidewalk therefore an easement will be required from

the county. Despite this we are still able to accommodate the county standards for landscape along green Valley albeit less than what was approved and preferred.

2. Visual screening of the south and south east of the carwash is accomplished in two levels. The Arbor/Trellis panels have been raised to 7'-6" with a dense "Green Screen"™ that is conducive to vine growth. The plant materials are called out on the attached landscape plan. This is the first level of visual screen for the stacking lanes. The only exception to the 7'-6" height is the initial panels near Sophia for sight distance safety. The panels that are used on the south east corner extending to the carwash entry are solid simulated wood precast panels that will provide better sound attenuation. While not aesthetically pleasing as the green screen, it cannot be seen from the homes and will have shrubbery to cover it as the retaining wall was moved to the east property line creating a site level bed. In our opinion the redwoods or the alternate proposed pine tree for screening is excessive considering the east adjacent lot is commercially zoned and the trees do not provide a sound barrier. We showed these because you asked for them but feel they are of no real value to you or the developer. We could get by with nicer looking trees in this area. The area directly behind the building to the south was changed to be more landscape than hardscape and to accommodate the proposed redwood trees. The stacking lanes were each reduced to 10'-6" to accommodate more space to plant the trees.

3. Roofing change is proposed to be Boral Tile or an equal simulated tile that is of lighter weight. We are attaching the selected tile cut sheet for your review. This may not be the ultimate tile we select but it is the profile and color that we are pursuing. Revised building elevations will follow under separate transmittal.

Please review and respond with any questions or comments by Monday morning 10:00 am due to the uncertainty of a continuance by the Board at the meeting on the 5th. This transmittal does not in any way constitute our agreement to make these changes nor does it convey that these changes are necessary or better in any way than what has already been approved by the Planning Commission. These changes will be only become effective upon written agreement between the parties.

Thank you for your consideration and feel free to call Marc, Craig or myself. Enjoy your weekend and see you at the hearing!

Daniel B. Goalwin

Barghausen Consulting, Inc.

18215 72nd Ave South

Kent, WA 98032

Direct| 425.656.7441 - Office| 425.251.6222 - Cell| 206.396.8589

 Please consider the environment before printing this email.

--
Amy L. Anders
(310) 995-1777

