

**File No. TM14-1520 /
Z14-0007 / PD14-0006
Location Map**

Saratoga Estates
Tentative Subdivision Map

 Saratoga Estates Site

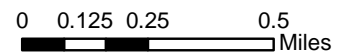

Exhibit A

POR. SECS. 2, 3, 10 & 11, T.9N., R.8E., M.D.M.



Acres are Estimates

It is prepared by the El Dorado Co. for public purposes only. Area calculations are not guaranteed. Users should verify some data.

Exhibit B

Rev. June 12, 2006

Assessor's Map Bk. 1;
County of El Dorado

Adjacent Map Pages Shown in Grey Text
Assessor's Block Numbers Shown in Ellipses
Assessor's Parcel Numbers Shown in Curly Braces

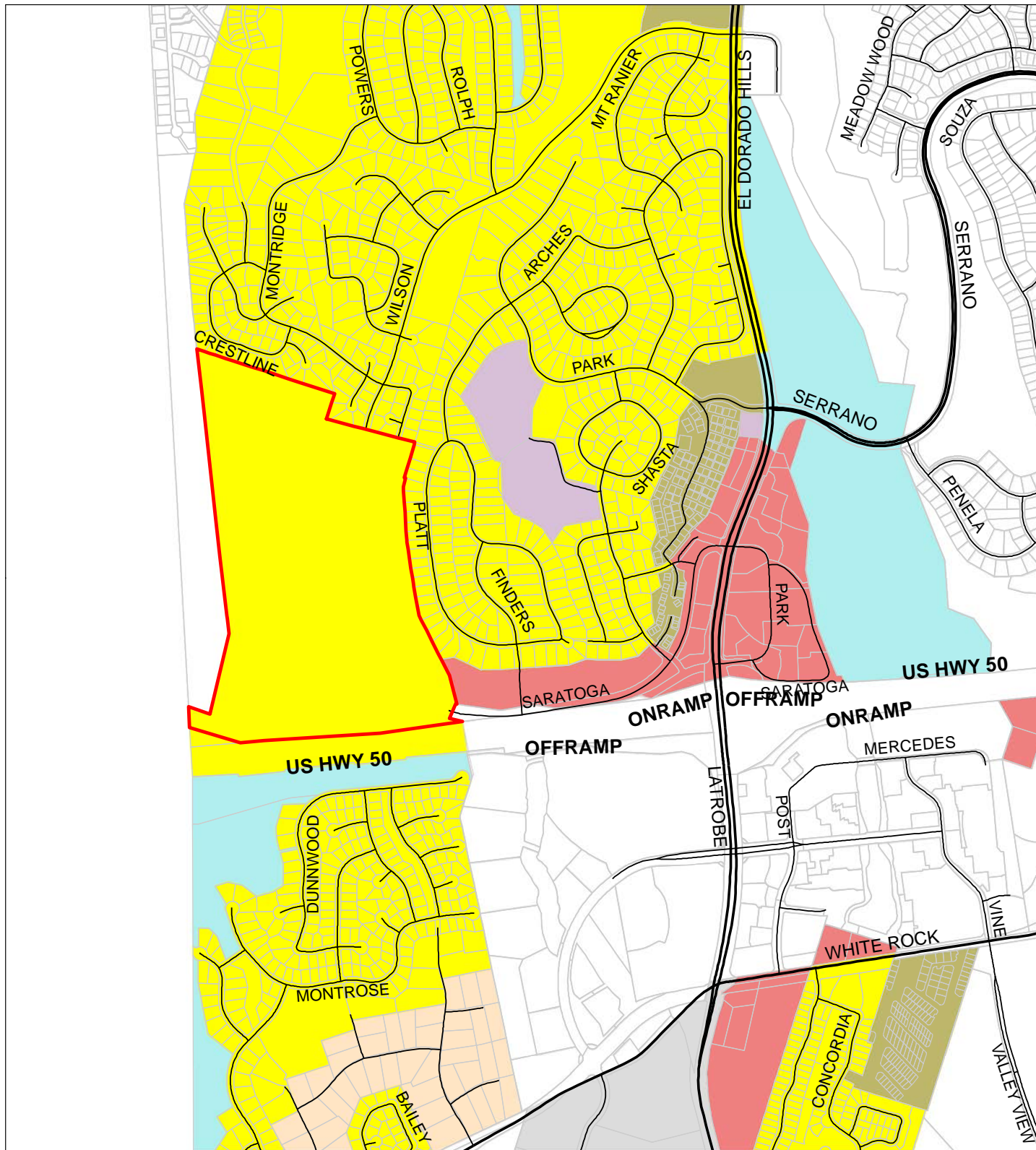

**File No. TM14-1520 /
Z14-0007 / PD14-0006
Land Use Map**

Saratoga Estates
Tentative Subdivision Map

- Saratoga Estates Site
- Adopted Plan
- Commercial
- High Density Residential
- Medium Density Residential

- Multi-Family Residential
- Open Space
- Public Facilities
- Research & Development

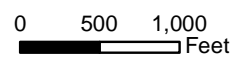
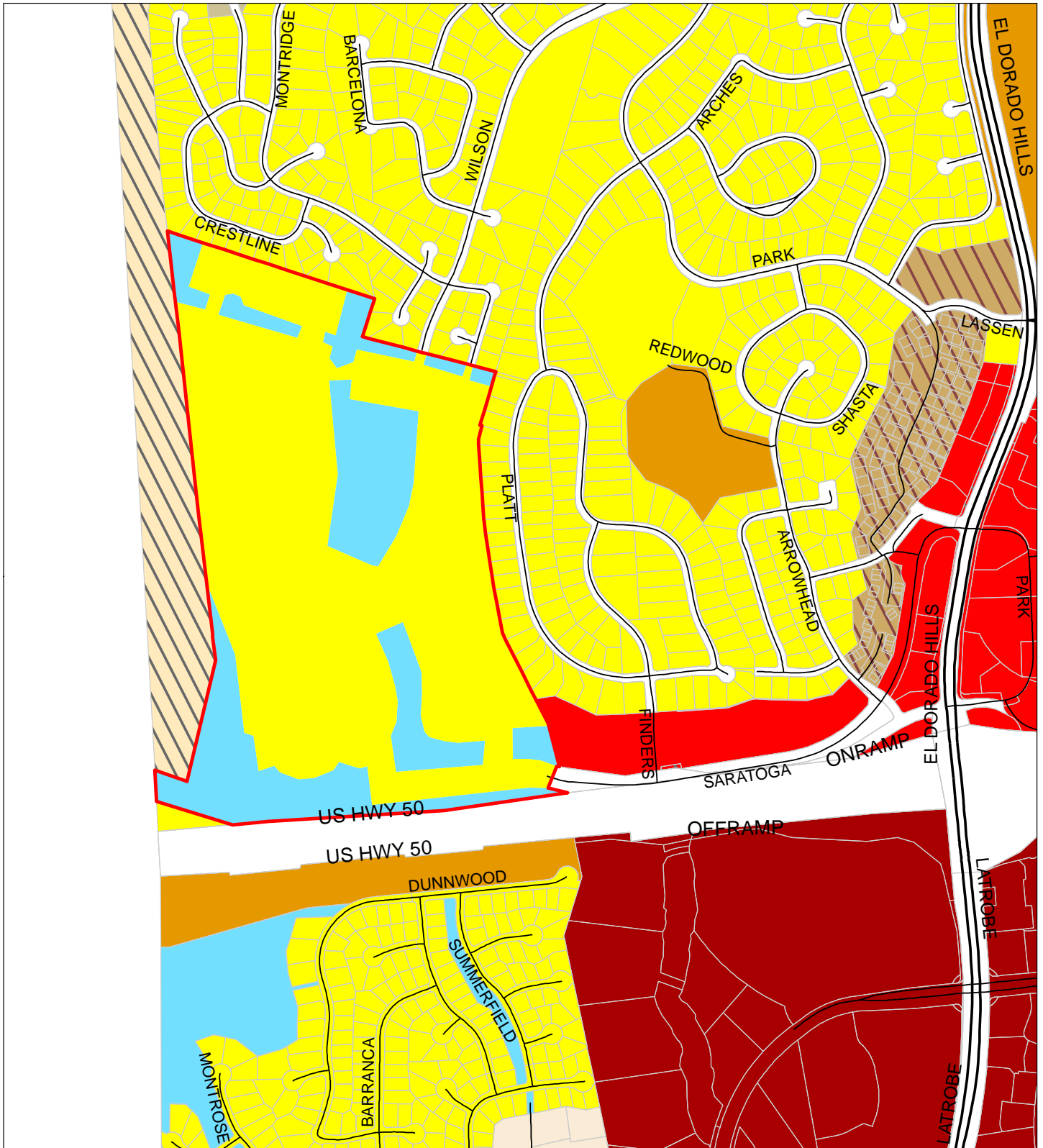

Exhibit C



**File No. TM14-1520 /
Z14-0007 / PD14-0006
Zoning Map**

Saratoga Estates
Tentative Subdivision Map

- | | |
|------------------------------|-----------------------------------|
| Saratoga Estates Site | RM = Residential Multi-Unit |
| CC = Commercial Community | R20K = Residential 20,000 |
| CG = Commercial General | R1A = Residential 1 Acre |
| CL = Commercial Limited | RF-H = Recreational Facility High |
| OS = Open Space | PR-SP = Promontory Specific Plan |
| R1 = Residential Single Unit | TC = Transportation Corridor |
| | PD - Planned Development Overlay |

0 250 500
Feet



SITE PLAN SARATOGA ESTATES

COUNTY OF EL DORADO

JULY, 2015

STATE OF CALIFORNIA

LEGEND

	PROJECT BOUNDARY		LANDSCAPE LOTS (6.2 AC)
	6,000-9,000 SF LOTS		(E) DRAINAGE
	7,700-19,000 SF LOTS	PEDESTRIAN CIRCULATION	
	OPEN SPACE (27.4 AC)		ATTACHED 6' SIDEWALK
	PARKS (8.3 AC)		(E) PEDESTRIAN FACILITIES
TOTAL RESIDENTIAL UNITS - 317			OPEN SPACE TRAIL
			FUTURE TRAIL
			DETACHED 6' SIDEWALK
			SOUND WALL

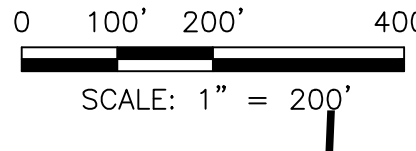
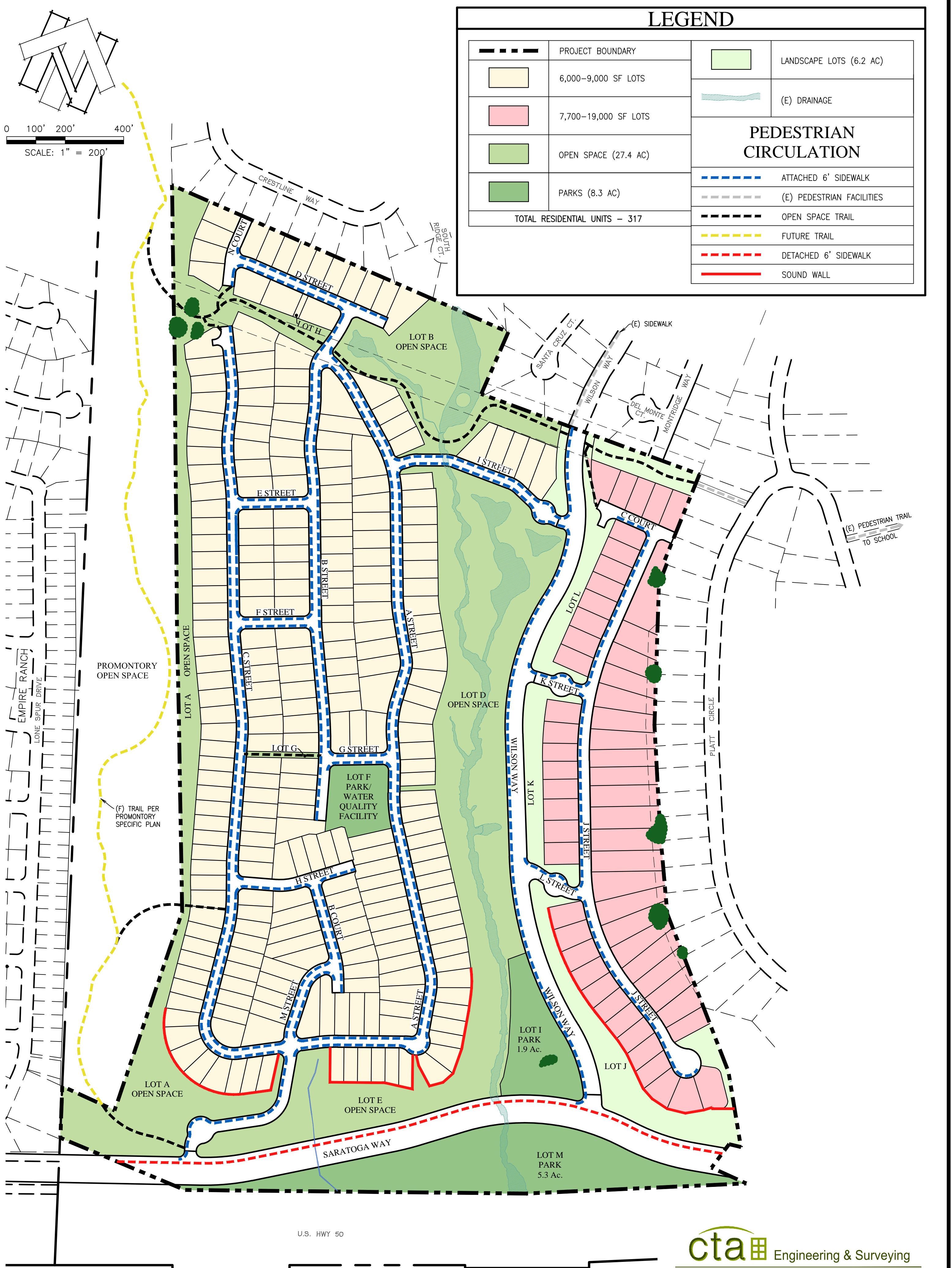

Exhibit E

cta Engineering & Surveying
Civil Engineering ■ Land Surveying ■ Land Planning
3233 Monier Circle, Rancho Cordova, CA 95742
T (916) 638-0919 ■ F (916) 638-2479 ■ www.ctaes.net

OWNERS OF RECORD

MIN NAN TSUNG & GERI CHI CHEN
4738 SAINT ANDREWS DRIVE
STOCKTON, CA 95219

APPLICANT

RENASCI DEVELOPMENT
28118 AGOURA ROAD, SUITE 105
AGOURA HILLS, CA 91301

ENGINEER

cta Engineering & Surveying
Civil Engineering • Land Surveying • Land Planning
3233 Morner Circle, Rancho Cordova, CA 95742
T (916) 638-0919 • F (916) 638-2475 • www.cta.com

TENTATIVE MAP

SARATOGA ESTATES

PORTION OF SECTIONS 3 & 10 T.9 N., R. 8 E, MDM

COUNTY OF EL DORADO

DECEMBER, 2015

STATE OF CALIFORNIA

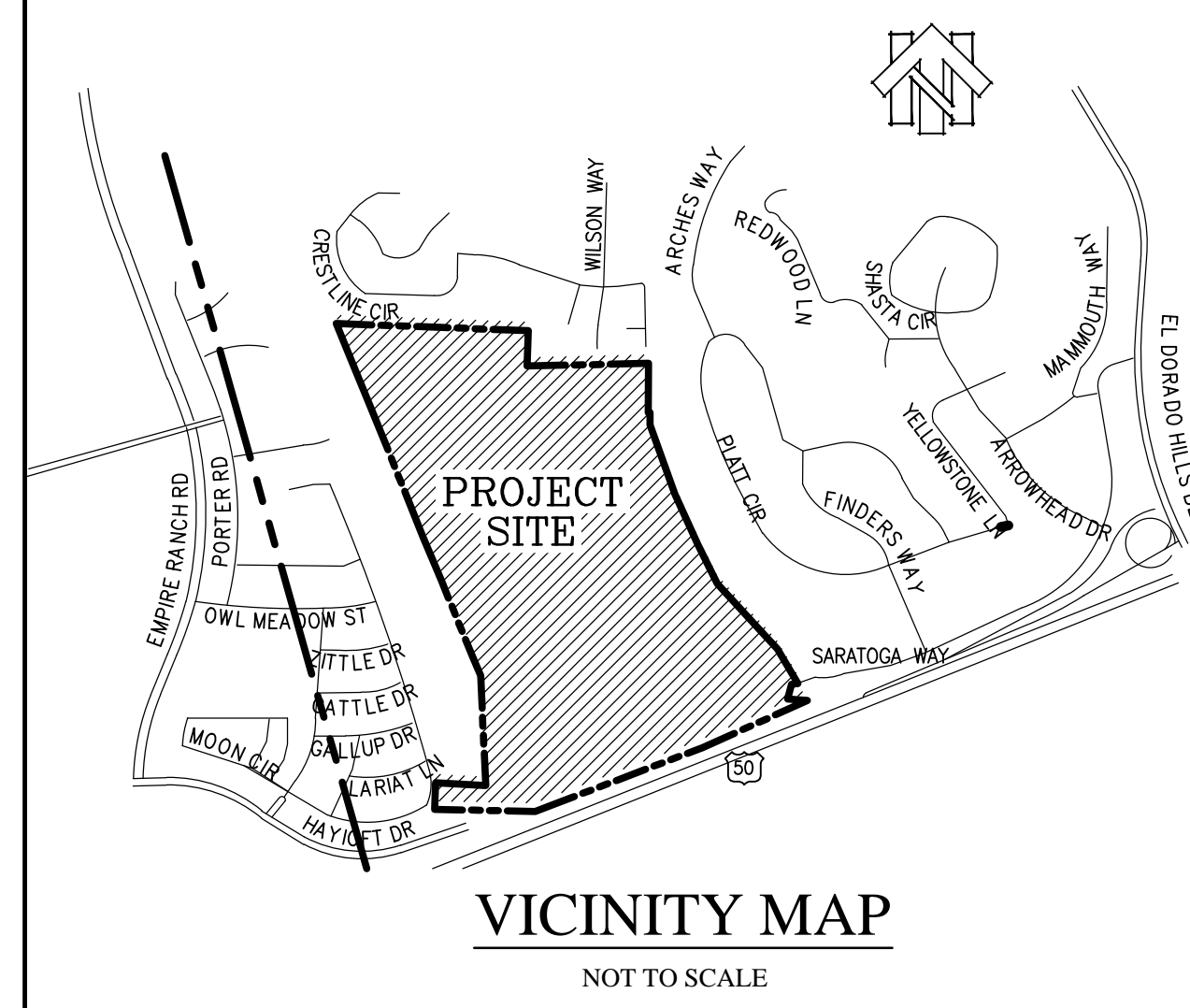

MAP SCALE

1" = 100'

CONTOUR INTERVAL

CONTOUR INTERVAL = 5 FOOT

SOURCE OF TOPOGRAPHY

AERIAL PHOTOGRAPHY

SECTION, TOWNSHIP and RANGE

PORTION OF S. 1/2 OF SECTION 3 &
PORTION OF N. 1/2 OF SECTION 10
T.9 N., R. 8 E., M.D.M

ASSESSOR'S PARCEL NUMBERS

A.P.N. 120-070-02

PROPOSED ZONING

R1- PD

PRESENT ZONING

R1

TOTAL AREA

121.28 ACRES

TOTAL NUMBER OF PARCELS

317 - RESIDENTIAL LOTS.....58.12 AC
12 - OPEN SPACE & LANDSCAPE LOTS (35%).....41.86 AC
4 - ROADWAY LOTS.....21.30 AC
329 LOTS TOTAL.....121.28 AC

MINIMUM LOT AREA

6,000 SQUARE FEET

WATER SUPPLY and SEWAGE DISPOSAL

EL DORADO IRRIGATION DISTRICT

PROPOSED STRUCTURAL FIRE PROTECTION

EL DORADO HILLS COUNTY WATER DISTRICT

DATE OF PREPARATION

DECEMBER, 2015

PHASING PLAN NOTICE

THE SUBDIVIDER MAY FILE MULTIPLE FINAL MAPS FOR THIS PROJECT. THE SUBDIVIDER SHALL NOT BE REQUIRED TO DEFINE THE NUMBER OR CONFIGURATION OF THE PROPOSED MULTIPLE FINAL MAPS. (PER THE SUBDIVISION MAP ACT, SECTION 66456.1)

ENGINEER'S CERTIFICATE

I HEREBY CERTIFY THAT TO THE BEST OF MY KNOWLEDGE THE LAND DEVELOPMENT KNOWN AS "SARATOGA ESTATES" HAS BEEN DESIGNED IN ACCORDANCE WITH THE SPECIFICATIONS AND GUIDELINES ESTABLISHED BY THE COUNTY OF EL DORADO.

OLGA SCIORELLI R.C.E. 71204

DATE

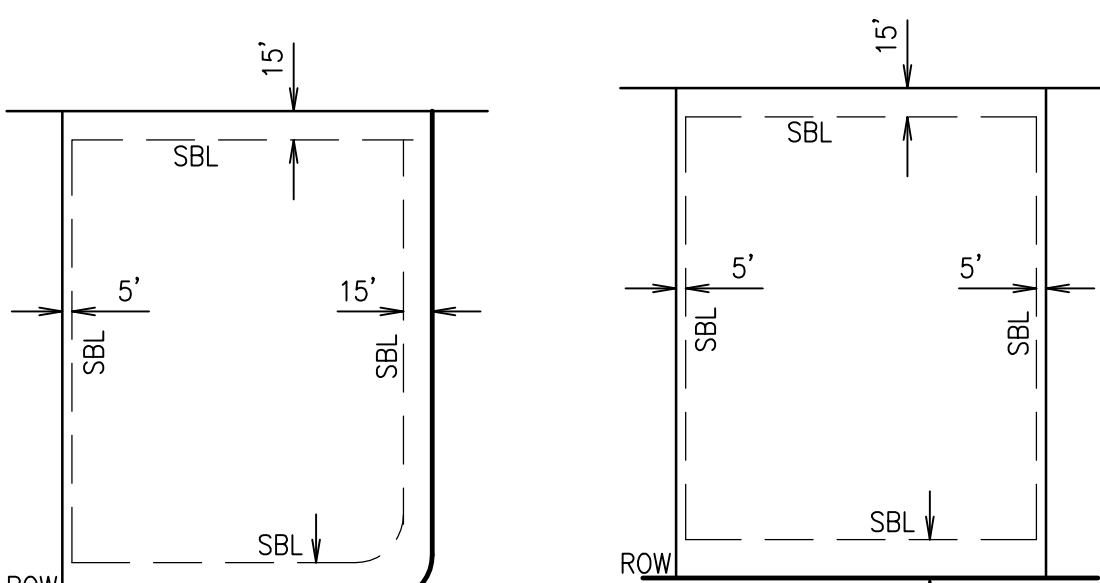

TYPICAL BUILDING SETBACKS
ONE-FAMILY RESIDENTIAL (R1 PD)

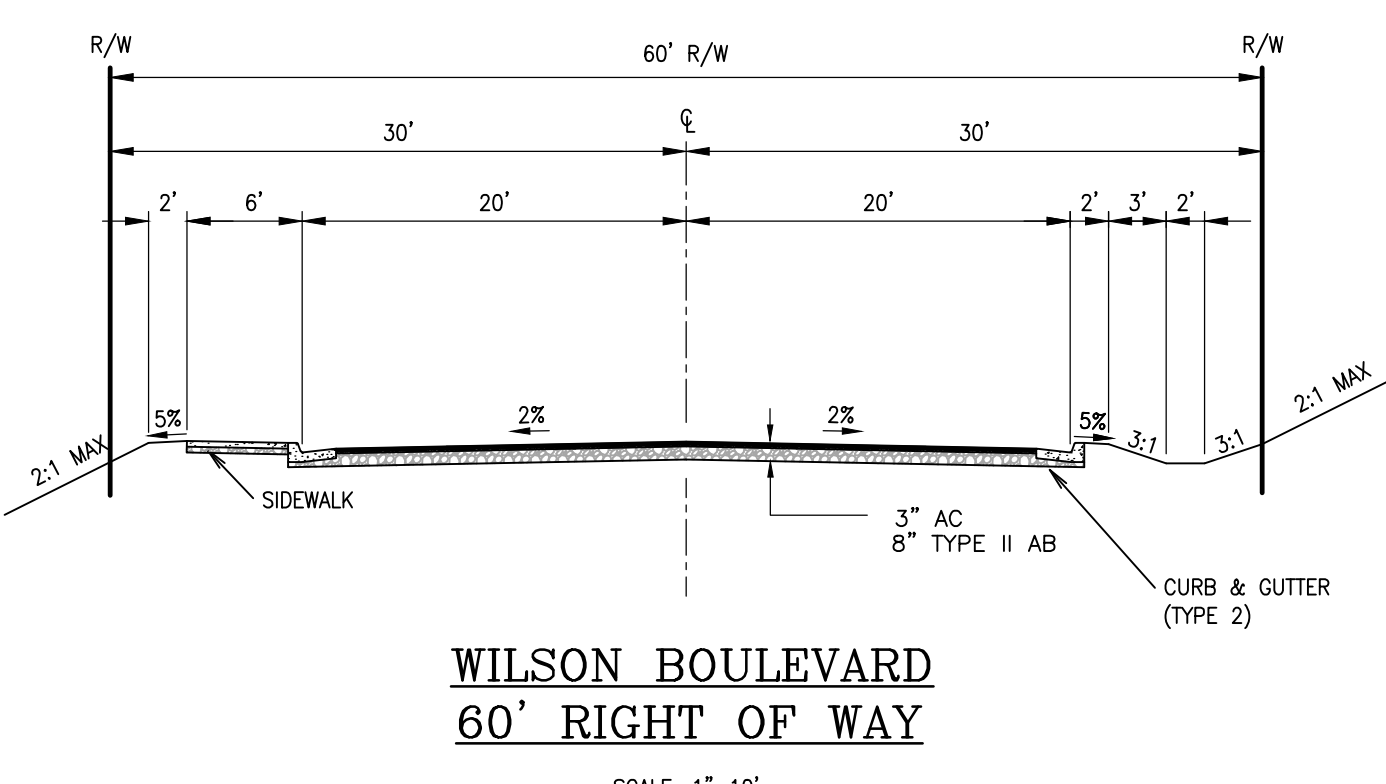

WILSON BOULEVARD
60' RIGHT OF WAY

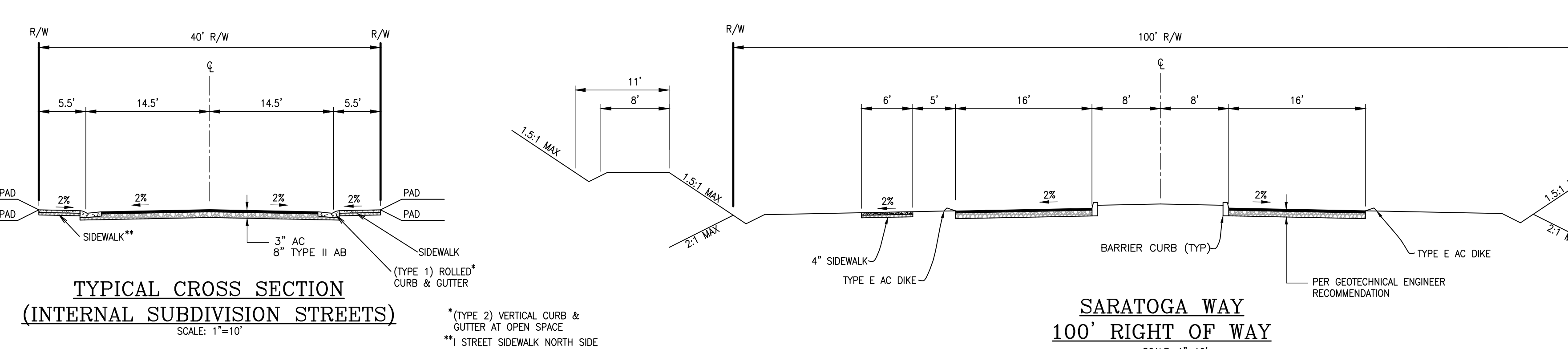

TYPICAL CROSS SECTION
(INTERNAL SUBDIVISION STREETS)

SARATOGA WAY
100' RIGHT OF WAY

LEGEND

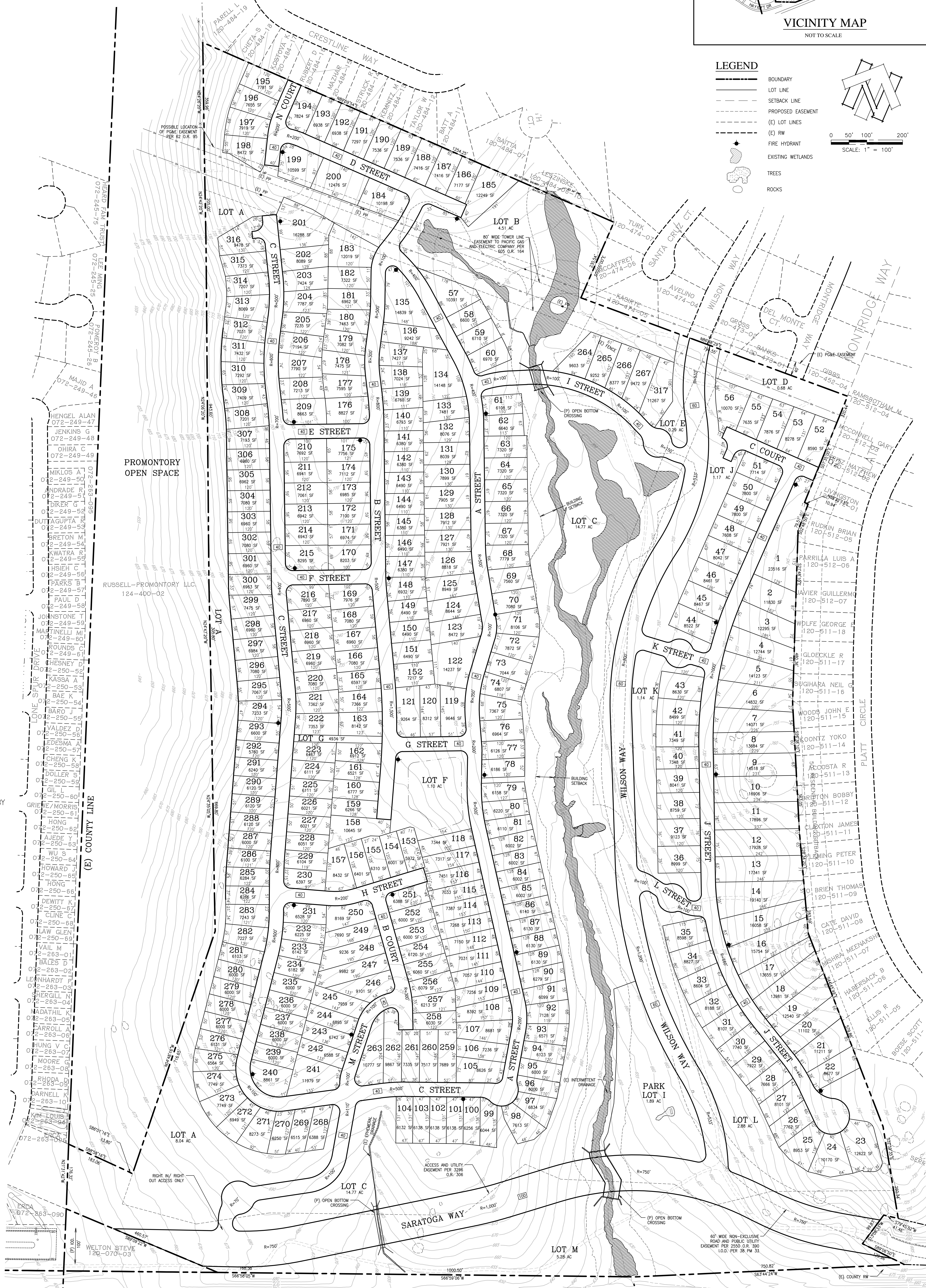
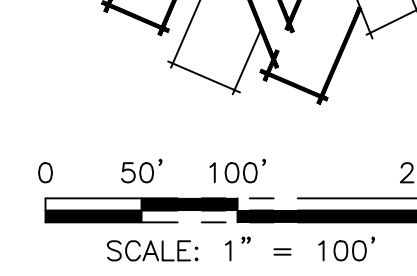
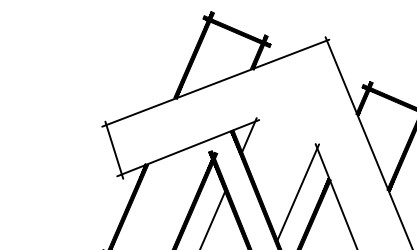
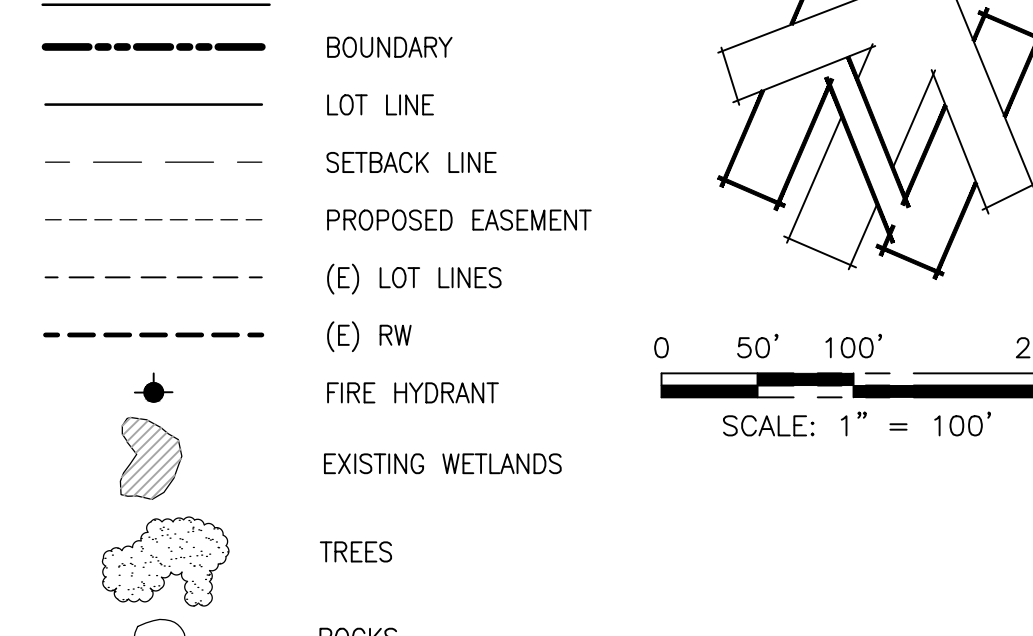

PLANNING COMMISSION
APPROVAL/DENIAL DATE: _____
BOARD OF SUPERVISORS:
APPROVAL/DENIAL DATE: _____

cta Engineering & Surveying
Civil Engineering • Land Surveying • Land Planning
3233 Morner Circle, Rancho Cordova, CA 95742
T (916) 638-0919 • F (916) 638-2475 • www.cta.com

**RECORDING REQUESTED BY
AND WHEN RECORDED MAIL TO:**

County of El Dorado
2850 Fairlane Court
Placerville, CA 95667
Attn: Director of Development Services

EXEMPT FROM RECORDING FEES
PER GOVERNMENT CODE §27383

(SPACE ABOVE THIS LINE RESERVED FOR RECORDER'S USE)

**COMMUNITY BENEFIT AND
DEVELOPMENT AGREEMENT**

BY AND BETWEEN

COUNTY OF EL DORADO

AND

RENASCI DEVELOPMENT

Effective Date: _____, 2016

**Community Benefit and Development Agreement
Between the County of El Dorado and**

**For the Development Known as
the Saratoga Estates Project**

This Community Benefit and Development Agreement (hereinafter “**Agreement**”) is made and entered into this ___ day of _____, 2016, by and between the **County of El Dorado** (hereinafter “**County**”) and _____ (hereinafter “**Developer**”), pursuant to the authority of Sections 65864 through 65896.5 of the California Government Code and Chapter 17.85 of the County's Ordinance Code relating to development agreements.

Recitals

This Agreement is entered into based on the following facts and circumstances, among others:

A. The County of El Dorado, a semi-rural County located in the Sacramento metropolitan region, prides itself on providing a high quality of life to its residents. The County strives to balance the need for a healthy, diverse economy, including a wide variety of commercial and retail opportunities, and adequately financed and maintained infrastructure, with a healthy, sustainable, natural environment.

B. The El Dorado Hills area has been identified by the County for many years as one of the primary areas affording an opportunity for providing residential development to serve the County’s current and future growth.

C. Developer is in the business of developing residential communities in California. The Developer has an equitable interest in approximately 122 acres of real property which is commonly known as the Saratoga Estates Property (the “**Property**”). The Property is located within the El Dorado Hills area of the County adjacent to Highway 50 and the City of Folsom. The Property is located within an area of the County designated as Community Region in the County’s General Plan with a General Plan designation of High Density Residential and is currently zoned R1 (one family residential district) and OS (open space district).

D. Developer submitted a proposal to build 317 residential units on the Property with lots ranging in size from 6000 square feet to 19,000 square feet (the “**Project**”) as depicted in Exhibit 1, attached hereto. The Property consists of 122 acres, El Dorado County Assessor’s Parcel No.120-070-02.

E. The Project includes the design and construction of a key element in the County’s transportation plan consisting of connecting Saratoga Road in El Dorado Hills to Iron Point Road in the City of Folsom, which will provide a surface road connection between the two communities resulting in reduced traffic on Highway 50. The parties enter into this Agreement in part to provide assurances as to the timing of construction of Saratoga Road and the means of financing such construction.

F. To strengthen the public planning process, encourage private participation in comprehensive planning and reduce the economic risks of development, the Legislature of the State of California adopted Sections 65865 et seq. of the California Government Code enabling a County and an applicant for a development project to enter into a development agreement establishing with certainty what zoning standards and land use regulations of the County will govern the construction and implementation of the development project from beginning to completion.

G. County hired a consultant to prepare an Environmental Impact Report (State Clearinghouse #2015032058) for the Project. The public comment period for the Environmental Impact Report ran from _____ to _____. On _____, 2016, the County Planning Commission considered the EIR and the Project and, after having conducted duly noticed public hearings, recommended certification of the EIR and approval of the Project to the County Board of Supervisors. On _____, 2016, the County Board of Supervisors held duly noticed public hearings on the Project. At the conclusion of these hearings, the County Board of Supervisors, after making specific findings, certified the EIR, made a Statement of Overriding Considerations, and adopted the Mitigation Monitoring and Reporting Program (MMRP) for the Project, and approved the Project consisting of a Rezoning to re-align the boundaries of the R1 and OS zoning, a Planned Development, a Development Plan and a tentative map for the Project and certain Design Waivers.

H. On _____, 2016, the Board of Supervisors introduced Ordinance No. ___ approving this Agreement and authorizing its execution, and adopted such Ordinance on _____, 2016, with the Effective Date as set forth in Section 1.2.

Definitions

The following words or phrases used in this Agreement shall have the meanings set forth in this Section. All words not specifically defined shall be deemed to have their common meaning and/or the meaning generally given to such words in the parlance of the planning and development of real property in the State of California.

- A. “Affordable Housing Fee” has the meaning described in Section 3.2.4.
- B. “Agreement” means this Community Benefit and Development Agreement.
- C. “Applicable General Plan” means the County’s General Plan, adopted on July 19, 2004, as amended through.
- D. “CIP” means that list of projects contained within the County of El Dorado Transportation Division Capital Improvement Program, as adopted by the Board of Supervisors and as may be updated and amended from time to time by the Board.

- E. “Conditions of Approval” mean the requirements placed on the Project Approvals as conditions to development of the Project. A copy of the Conditions of Approval is attached as Exhibit 2.
- F. “County” means the County of El Dorado.
- G. “CSD” has the meaning described in Section 3.2.2.
- H. “Developer” means _____, or its successors in interest.
- I. “Effective Date” has the meaning described in Section 1.2.
- J. “EIR” means Final Environmental Impact Report for the Saratoga Estates Project, State Clearinghouse No. 2015032058, certified by the Board of Supervisors on _____, 2016.
- K. “Mitigation Measures” mean the requirements placed on the Property to cure or lessen the environmental impacts of the Project as identified in the analysis of the Project done in the EIR. The Mitigation Monitoring and Reporting Program adopted with the Project is attached as Exhibit 3.
- L. “Property” means the property commonly known as the Saratoga Estates Property, currently identified as El Dorado County Assessor’s Parcel No. 120-070-02. A map showing the location and boundaries of the Property is attached as Exhibit 4, and the legal description describing the Property is attached as Exhibit 5.
- M. “Project” means the Saratoga Estates Project as described in the Recitals.
- N. “Project Approvals” mean the development approvals and entitlements set forth in Section 2.1.
- O. “Traffic Impact Mitigation Fee Program” or “TIM Fee Program” means that program wherein fees are charged by the County on new development for the purpose of funding the construction of road improvements identified in the County CIP.

SECTION 1. - GENERAL PROVISIONS

1.1. All Exhibits Deemed Incorporated by Reference. Unless specifically stated to the contrary, the reference to an exhibit by a designated letter or number shall mean that the exhibit is made a part of this Agreement.

1.2. Agreement to be Recorded; Effective Date. When fully executed, this Agreement will be recorded in the Official Records of El Dorado County, pursuant to Government Code Section 65868.5. The effective date of this Agreement shall be the later of (a) the date that is thirty (30) days after the date that Ordinance enacting this Agreement is adopted, or (b) the date this Agreement is fully executed by the Parties (“**Effective**

Date”). The Effective Date is inserted at the beginning of this Agreement. The Parties acknowledge that section 65868.5 of the Development Agreement Statute requires this Agreement to be recorded in the Official Records no later than ten (10) days after the County enters into this Agreement.

1.3. Term. The term of this Agreement is twenty years, commencing on the Effective Date. The expiration date for the tentative map shall be extended for the term of this Agreement.

1.4. Termination. This Agreement shall be deemed terminated and of no further effect upon the occurrence of any of the following events:

1.4.1. Expiration of the twenty (20) year term;

1.4.2. Entry of a final court judgment or issuance of a final court order directed to the County to set aside, withdraw, or abrogate the County’s approval of this Agreement or any material part of the Project Approvals; or

1.4.3. The effective date of a party’s election to terminate the Agreement as provided in Section 5.2 of this Agreement.

1.4.4. As to a single residential lot within the Project, upon the final building permit and the conveyance of such lot to a bona fide good faith purchaser. Such termination shall be automatic without any further action by either party or the need to record any further documents.

1.5. Interest of Developer. Developer represents that it has a controlling interest in the Property and that all other persons or entities holding legal or equitable interests in the Property are to be bound by this Agreement.

1.6. Covenants Running With the Land. Any successors in interest to the County or Developer shall be subject to the provisions set forth in Government Code Sections 65865.4 and 65868.5. All provisions of this Agreement shall be enforceable as equitable servitudes and constitute covenants running with the land. Each covenant to do, or refrain from doing, some act with regard to the development of the Property (a) is for the benefit of and is a burden upon the Property; (b) runs with the Property and every portion thereof; and (c) is binding upon each Party and each successor in interest during ownership of the Property or any portion thereof. Nothing herein shall waive or limit the provisions of Section 2.4, and no successor owner of the Property, any portion of it, or any interest in it shall have any rights except those assigned to the successor by Developer in writing pursuant to Section 1.7.

1.7. Right to Assign; Non-Severable Obligations.

1.7.1. Except as otherwise provided, Developer shall have the right to sell, encumber, convey, assign or otherwise transfer (collectively “assign”) in whole or in part, its rights, interests and obligations under this Agreement to a third party during the term of this Agreement, provided written notice of such assignment is given to County.

1.7.2. The obligations and conditions set forth in this Agreement are not severable, and any sale of the Property, in whole or in part, or assignment of this Agreement, in whole or in part, which attempts to sever the obligations and/or conditions shall be a nullity and shall have no force or effect.

1.8. Amendment of Agreement. This Agreement may be amended from time to time by mutual consent of the County and Developer, as provided in Government Code Section 65868. The cost to the County in processing such a proposed amendment shall be paid by the requesting party.

1.9. Whole Agreement. This Agreement, together with any subsequent amendments, shall constitute the entire agreement of the Parties as to the development of the Property. All prior agreements of the Parties, whether written or oral, are of no further force and effect.

1.10. Modification to the Project Approvals. Developer may apply, in writing, to modify the Project Approvals. Such modification may be processed without any amendment to this Agreement, if the County, in its sole discretion, determines that the requested modification (1) is consistent with this Development Agreement, (2) does not alter this Agreement's term, provisions for reservation and dedication of land, or monetary contributions, (3) does not substantially alter the permitted uses, density or intensity of use, and (4) is consistent with the Applicable General Plan. If the County determines that the requested modification is inconsistent with this Agreement, alters its term or substantially alters its uses, the modification will not be processed without processing a concurrent amendment to this Agreement in accordance with Section 1.8.

1.11. Waivers. Waiver of a breach or default under this Agreement shall not constitute a continuing waiver or a waiver of a subsequent breach of the same or any other provision of this Agreement.

1.12. Severability. If any term or provision of this Agreement, or the application of any term or provision of this Agreement to a specific situation, is found to be invalid, or unenforceable, in whole or in part for any reason, the remaining terms and provisions of this Agreement shall continue in full force and effect unless an essential purpose of this Agreement would be defeated by loss of the invalid or unenforceable provisions, in which case either Party may terminate this Agreement by providing written notice thereof to the other Parties. In the event of such termination, the provisions of Section 1.4 relating to termination of the Agreement by mutual written consent shall apply. Without limiting the generality of the foregoing, no judgment determining that a portion of this Agreement is unenforceable or invalid shall release Developer from its obligations to indemnify the County under this Agreement.

1.13. Choice of Law; Venue. This Agreement shall be interpreted according to the laws of the State of California. The venue for any litigation concerning its meaning shall be the Superior Court of El Dorado County, California.

1.14. Notices. All notices required or provided for under this Agreement shall be in writing and delivered in person or sent by certified mail, postage prepaid, return receipt requested, to the principal offices of the County and Developer or Developer's assigns and successors. Notice shall be effective on the date delivered in person, or the date when the postal authorities indicate that the mailing was delivered to the address of the receiving party indicated below:

Notice to the County: County of El Dorado
2850 Fairlane Court
Placerville, CA 95667
Attn: Director of Development Services

Notice to Developer: Renasci Development
28118 Agoura Road, Suite 105
Agoura Hills, CA 91301

1.15. No Third Party Beneficiaries. This Agreement is made and entered into for the sole protection and benefit of the parties and their successors and assigns. No other person shall have any right of action based upon any provision in this Agreement.

1.16. List of Exhibits.

Exhibit 1- Site Plan
Exhibit 2- Conditions of Approval
Exhibit 3- Mitigation Monitoring and Reporting Plan
Exhibit 4- Project Boundary Map
Exhibit 5- Legal Description of Property
Exhibit 6- Saratoga Way Configuration

SECTION 2. - DEVELOPMENT OF THE PROPERTY

2.1. Project Approvals. The Property shall be developed in accordance with the Project Approvals. The Project Approvals shall consist of:

2.1.1. Rezones (Z14-0007) and Planned Development (PD14-0006) approved by the County; and

2.1.2. The Planned Development Site Plan and Tentative Map (TM14-1520); and

2.1.3. The Mitigation Monitoring and Reporting Program adopted with the Project, attached hereto as Exhibit 3.

2.2. Consistency with the General Plan.

The County finds that the provisions of this Agreement and the development of the Property are consistent with and conform to the 2004 General Plan of the County of El Dorado, as amended

through the adoption of the ordinance for this Agreement (“**Applicable General Plan**”). In determining that this Agreement is consistent with the Applicable General Plan, the County has specifically found that this Agreement and the Project are consistent with the recently enacted Measure E due to the roadway improvements called for in the EIR, Conditions of Approval and this Agreement.

2.3. Vested Rights of the Developer. Developer shall have the vested right to develop the Property in accordance with the Project Approvals described in Section 2.1 above and in conformity with the County rules, regulations, policies, standards, specifications and ordinances, including the zoning ordinance, in effect on the date of adoption of the ordinance for this Agreement, provided that Developer is not in default under this Agreement. The vested right to proceed with the Project shall be subject to any subsequent discretionary approvals required in order to complete the Project provided that any conditions, terms, restrictions, and requirements for such subsequent discretionary approvals shall not prevent development of the land for the uses and to the density or intensity of development or rate or timing of development set forth in this Agreement and the Project Approvals.

2.4. Rights Retained by the County. Notwithstanding any other provisions of this Agreement, including the vesting granted by Sections 2.1, the following regulations and provisions shall apply to the development of the Property:

2.4.1. Application fees and charges of every kind and nature imposed by the County to cover the actual costs to the County of processing development applications or for monitoring compliance with any land use entitlements granted or issued.

2.4.2. Procedural regulations related to hearing bodies, applications, notices, findings, hearings, reports, appeals and any other matter of procedure, provided such procedures are uniformly applied on a county-wide basis to all substantially similar types of development projects and properties.

2.4.3. Regulations governing construction standards and specifications, including, without limitations, the County’s building code, plumbing code, mechanical code, electrical code and grading code and all other uniform construction codes then applicable in the County at the time of permit application, provided such regulations are uniformly applied on a county-wide basis to all substantially similar types of development projects and properties.

2.4.4. New County laws or regulations that are mandated by state or federal law.

2.4.5. New County laws and regulations which are reasonably necessary to protect the public health and safety, provided that such laws and regulations are uniformly applied on a county-wide basis to all substantially similar types of development projects and properties.

2.4.6. Any fees, taxes, assessment, and charges which are in effect and collected at the time of the approval of a subsequent entitlement or the issuance of a Building Permit, as provided in this Agreement or as generally applicable throughout

the County, including but not limited to impact fees, provided that such fees, taxes and assessments apply to all similar private projects within the County and are reasonably related to the cost of the facility or service for which the fee or assessment is imposed. For any fees that are assessed by zone or area, “similar private projects” will mean projects in the same zone or area as the Project.

2.5. Revisions to Project Approvals. Developer may apply, in writing, to revise the Project Approvals. If the Director of Development Services, or his/her designee, determines, in his sole discretion, that the requested revision is (1) a minor change to the Project considered as a whole; (2) does not increase the density or intensity of the use approved in the Project Approvals; (3) is consistent with this Agreement; (4) is consistent with the Applicable General Plan; and (5) does not change the analysis contained in the EIR, the Director of Development Services or his/her designee may approve the requested revision without public hearing. The notice and appeal process for such a revision shall be the same process as for any other Director of Development Services approval at the time of the action requested. If the Director of Development Services determines the application does not comply with the above, then it shall be processed with all applicable public hearing and notice provisions then in effect.

SECTION 3. - OBLIGATIONS OF THE PARTIES

3.1. Property Development. The Property shall be developed in accordance with the Project Approvals described in Section 2.1 above.

3.2. Developer Obligations. The following obligations of Developer are provided as consideration for County entering into this Agreement.

3.2.1. Saratoga Way Construction. Developer shall design and construct Saratoga Way, in accordance with plans approved by the County, from the intersection of the existing Saratoga Way to the point of connection with Iron Point Road in the City of Folsom in the configuration as shown on Exhibit __, attached hereto. Developer shall provide the financing for the construction of the improvements subject to reimbursement as provided herein. Such financing may take the form of public financing such as a community facilities district, or participation in the Statewide Community Infrastructure Program (SCIP) with County’s cooperation.

3.2.1.1. Timing of Construction. The improvement plans for Saratoga Way shall be submitted prior to, or concurrently with, the first final map filed for the Project. At the time that improvement plans are approved by the County, the parties shall enter into a road improvement agreement, which shall provide the mechanics of bonding, construction, and the County’s acceptance of the road improvements. Construction of the Saratoga Way improvements shall begin with the initial construction of improvements for the Project and shall be completed to the Project’s entrance point on Saratoga Way prior to a final residential building permit within the Project. Although it is the intent of the parties that Saratoga Way be fully constructed as part of the initial phase of development of the Project, the County agrees that should the acquisition of offsite right of way as provided below in Section 3.2.2.1, or other delays arise associated with the connection of Saratoga Way to Iron Point Road in the

City of Folsom, Developer shall be entitled to construct homes within the Project, provided that no more than one hundred (100) final building permits may be completed within the Project until such time as the connection is fully completed.

3.2.2. Saratoga Way Right of Way. Developer shall grant to the County the necessary right of way for the ultimate planned configuration of Saratoga Way across the Property. As partial consideration for this Agreement, Developer agrees that it shall be entitled to reimbursement for only fifty percent (50%) of the value of the right of way so granted. The parties agree that the value of the right of way property shall be calculated at its fair market value which has been determined to be Two Hundred and Twenty-Five Thousand dollars (\$225,000.00) per acre.

3.2.2.1 Offsite Right of Way. The Saratoga Way improvements will require the acquisition of right of way not owned by Developer. Developer will use its best efforts to acquire the needed right of way at the best possible price. However, if Developer is unable to acquire the property through good faith negotiation at or near the appraised value of the property to be acquired, the County agrees that it will utilize its power of eminent domain to acquire the needed property rights. The County's agreement to utilize eminent domain is a reflection of the importance of Saratoga Way to the County's overall circulation and Capital Improvement Plan and is not intended as a means to aid the Project as a private undertaking.

3.2.3. Park Maintenance Funding. Although the County is not responsible for park maintenance, the County recognizes that Developer shall, through the creation of the Landscape and Lighting District discussed below, be providing enhanced funding to the El Dorado Hills Community Services District ("CSD") that may be utilized by the CSD for the improvement and maintenance of community and regional facilities which will benefit the general population of El Dorado Hills and the County.

3.2.4. Affordable Housing Fee. Developer agrees that a fee will be collected at the time of the issuance of each residential building permit within the Project ("**Affordable Housing Fee**"). A portion of the revenue generated through collection of the Affordable Housing Fee may be used by the County for the purpose of financing studies or the development of a program for the provision of affordable housing within the County, and/or for the construction or other contribution towards creating housing in the County affordable to moderate income earners (defined in the Housing Element of the County's General Plan as earners with annual incomes greater than 80% but no more than 120% of the County average median income). For each residential building permit, the Affordable Housing Fee shall be Five Hundred Dollars (\$500), subject to annual adjustment on January 1 of each year for inflation as calculated under the Engineering News-Record National Construction Cost Index. The County shall grant credit for such payments against any fees, taxes, assessment, and charges related to affordable housing to which Section 2.5.6 applies. The obligations under this Section 3.2.4 shall survive expiration of the twenty (20) year term of this Agreement.

3.2.5. Park Dedication/Improvements. The Project contains areas designated for public parks. Developer intends to enter into a separate agreement with the El Dorado

Hills CSD with respect to such parks, but for the purposes of this Agreement and to the extent that County has a role in such matters, the parties agree as follows:

3.2.5.1 Park and Public Trail Improvements. Developer agrees that improvements to Lots I and M as shown on the Project tentative map as park parcels, together with public trail improvements shall be constructed by Developer and that the total cost of such improvements shall be a credit against park fees charged at the time of building permit issuance.

3.2.5.2 Land Dedications. Developer shall dedicate Lots I and M, and those areas depicted in the Project Approvals as public trails, which fully satisfies the Quimby Act obligations of the Project.

3.2.5.3 Park Maintenance Funding. Developer shall, in accordance with CSD policies, form a Landscaping and Lighting District which shall provide funding to the CSD for park maintenance, notwithstanding that the Fiscal Impact Analysis prepared for the Project shows that the tax revenues which shall accrue to the CSD exceed the cost of maintaining the parks proposed within the Project.

3.4. TIM Fee Credit/ Reimbursement. With respect to the Saratoga Way improvements and any other offsite roadway improvements which are included in the County's TIM Fee Program, the Parties will enter into a credit and/or reimbursement agreement providing the means and timing by which Developer will be provided credit and/or reimbursement for such improvements. With respect to the Saratoga Way improvement costs, including onsite and offsite right of way costs, such agreement shall provide that Developer shall receive credits against TIM fees payable at the time of the issuance of building permits. The amount of such credits will be that portion of the TIM fee which is allocated to local improvements (net of the Silva Valley Interchange set-aside and funds allocated to the State Highway system) up to the total amount of the actual costs of the creditable/reimbursable improvements. To the extent that the improvement and right of way costs exceed the amount of creditable TIM Fees, the remaining balance shall be reimbursed through TIM Fee revenues, so long as such revenues are available, over a six (6) year period beginning upon the acceptance of the Saratoga Way improvements by County and a reconciliation of the final cost of the improvements has been made, at a rate of fifteen percent (15%) of the outstanding balance in each of the first five years with the balance (25%) being paid in the sixth year.

CREDIT/REIMBURSEMENT EXAMPLE

TIM Fee Allowable Credit Base	\$ 23,340
Less Silva Valley Interchange Set-aside	(7,002)
Allowable TIM Fee Credit Per Unit	\$ 16,338
Qualified CIP-Related Creditable Cost	\$ 5,479,000
Allowable TIM Fee Credit Total (317 lots)	(5,179,000)
Balance of Reimbursable Costs after TIM Fee Credit	\$ 300,000*

* Amount is the excess expended for qualified CIP expenses realized by the Renasci Development subject to six (6) year reimbursement.

3.5. Timing of Development. The Parties acknowledge that Developer cannot at this time predict when or the rate at which phases of the Property will be developed. Such decisions depend upon numerous factors which are not within the control of Developer, such as the timing of construction of the roadway improvements, market orientation and demand, interest rates, absorption, competition and other similar factors. Since the California Supreme Court held in *Pardee Construction Co. v. City of Camarillo* (1984) 37 Ca1.3d 465, that the failure of the parties therein to provide for the timing of development resulted in a later adopted initiative restricting the timing of development to prevail over such parties' agreement, it is the parties' intent to cure that deficiency by acknowledging and providing that Developer shall have the right to develop the Property in such order and at such rate and at such times as Developer deems appropriate within the exercise of its subjective business judgment, subject only to any timing or phasing requirements set forth in this Agreement with respect to roadway improvements.

3.6. Connection to Public Improvements. County shall cooperate with Developer to connect, through the issuance of appropriate encroachment permits or cooperation with other agencies providing services, any improvements constructed under the Development Plan to existing or newly constructed public improvements, provided the costs of such connections are borne by Developer.

3.7. County Cooperation. County, through its officers, agents and employees, shall cooperate with Developer and support the Project as necessary to obtain other permits or approvals required from other government agencies to effectuate the development of the Property.

3.8. Public Financing. County agrees to cooperate with Developer in the formation and implementation of public financing districts or areas of benefit, such as, a Community Facilities District or Statewide Community Infrastructure Program districts. County and Developer shall use their best efforts to cause to be formed any such financing district(s) provided that such formation is consistent with applicable County ordinances or adopted policies regulating such matters. County agrees that any credits or reimbursements owed to Developer shall not be affected or reduced because improvements for which credits or reimbursements are due were financed with any special taxes or bond proceeds.

3.9. Funding and Construction of Public Improvements. Nothing in this Agreement shall be construed as obligating the County to fund, design or construct any specific projects or improvements at any specific time. The County shall not be obligated to expend monies from its general fund or from any source not identified in this Agreement to design or construct any improvements necessary for the development of the Property.

3.10. Changes in State or Federal Law. In the event changes in County law [based on changes to state or federal law] prevent or preclude, or render substantially more expensive or time consuming, compliance with one or more provisions of this Agreement, County and Developer shall meet and confer in good faith in order to determine whether such provisions of this Agreement shall be modified or suspended, or performance thereof delayed, as may be necessary to comply with such changes in the

law. County shall reasonably cooperate with Developer, at Developer's expense, in Developer's effort to obtain any permits, approvals, or entitlements that may be required as a result of modifications or suspensions made pursuant to this Section 3.11. Nothing in this Agreement shall preclude County or Developer from contesting by any available means (including administrative or judicial proceedings) the applicability to the Project of any such changes in the law. If changes in the law preclude or substantially prevent or preclude, or render substantially more expensive or time consuming, performance of this Agreement in a manner that makes the Project economically infeasible, Developer, in its sole and absolute discretion, may terminate this Agreement by providing written notice thereof to County.

3.11. Estoppel Certificate. Developer or its lender may, at any time, and from time to time, deliver written notice to County requesting County to certify in writing that: (a) this Agreement is in full force and effect; (b) this Agreement has not been amended or modified or, if so amended or modified, identifying the amendments or modifications; and (c) Developer is not in default of the performance of its obligations, or if in default, to describe therein the nature and extent of any such defaults. Developer shall pay, within thirty (30) days following receipt of County's invoice, the actual costs borne by County in connection with its review of the proposed estoppel certificate, including the costs expended by the County Counsel's Office in connection therewith. The Director of Development Services shall be authorized to execute any certificate requested by Developer hereunder. The form of estoppel certificate shall be in a form reasonably acceptable to the County Counsel. The Director of Development Services shall execute and return such certificate within thirty (30) days following Developer's request therefor. Developer and County acknowledge that a certificate hereunder may be relied upon by tenants, transferees, investors, partners, bond counsel, underwriters, bond holders and mortgagees. The request shall clearly indicate that failure of County to respond within the thirty-day period will lead to a second and final request. Failure to respond to the second and final request within twenty (20) days of receipt thereof shall be deemed approval of the estoppel certificate.

SECTION 4. - ANNUAL REVIEW

4.1. Annual Review. During the term of this Agreement, the County shall, once every calendar year, review the extent of good faith compliance by Developer with the terms of this Agreement. Such periodic review shall be limited in scope to compliance with the terms and conditions of this Agreement pursuant to California Government Code section 65865.1. This review shall be conducted pursuant to Section 130.85.026 of the County Ordinance Code.

SECTION 5. - DEFAULT, ENFORCEMENT AND REMEDIES

5.1. Application of Section. The Parties agree that the following provisions shall govern the availability of remedies should any of the Parties breach any of its obligations under this Agreement.

5.2. Default. Failure or delay by either party to perform any term or provision of this Agreement shall constitute a default, provided, however, the default by any successor in interest of Developer to whom Developer has assigned development rights pursuant to

Section 1.7, shall not be considered a default by Developer or by any other successor in interest of Developer. The County may institute proceedings pursuant to this Section against any individual defaulting party. In the event of alleged default or breach of any terms or conditions of this Agreement, the party alleging such default or breach shall give the other party not less than sixty (60) days' notice in writing specifying the nature of the alleged default and the manner in which said default may be satisfactorily cured. During any sixty (60) day period, the party charged shall not be considered in default for purposes of termination or institution of legal proceedings.

After notice of expiration of the sixty (60) day period, the party alleging default, at its option, may institute legal proceedings pursuant to Section 5.3 of this Agreement or give notice of intent to terminate the Agreement pursuant to California Government Code section 65868 or may pursue such other administrative remedies as may be appropriate. Following notice of intent to terminate, the matter shall be scheduled for a hearing before the County Board of Supervisors to consider and review the matter within sixty (60) calendar days. Following consideration of the evidence presented in the review, if no resolution of the matter is reached, either party alleging the default by the other party may give written notice of termination of this Agreement to the other party.

5.3. Remedies. In the event of an uncured default, the Parties' remedies under this Agreement are as follows:

5.3.1. An action for specific performance of an obligation of a Party, after giving that Party the opportunity to cure a default as provided in Section 5.2.

5.3.2. An action for injunctive relieve to preserve the physical or legal status quo of the development of the Project pending a judicial determination of the rights of the Parties in the event of a dispute between the Parties as to their rights and obligations under this Agreement.

5.3.3. An action for declaratory relief to determine the rights and obligations of the Parties under this Agreement.

5.3.4. Developer understands and agrees that the County would not be willing to enter into this Agreement if it created any monetary exposure for the County for damages (whether actual, compensatory, consequential, punitive or otherwise) in the event of a breach by the County. Developer specifically acknowledges that it may not seek monetary damages of any kind, and Developer hereby waives, relinquishes and surrenders any right to any monetary remedy. Developer hereby agrees to indemnify, defend, and hold the County harmless for any cost, loss, liability, expense or claim, including attorneys' fees, arising from or related to any claim brought by Developer inconsistent with the foregoing waiver.

SECTION 6 – HOLD HARMLESS AND INDEMNIFICATION

6.1. No Joint Venture or Partnership. County and Developer hereby renounce the existence of any form of joint venture or partnership between the County and Developer and agree that nothing contained herein or in any document executed in

connection herewith shall be construed as creating a partnership joint venture, or other legal entity between them.

In entering into this Agreement, the County is acting under the statutory and police powers that it holds as a political subdivision of the State of California which authorize it to regulate the development of land within its boundaries and to provide for the general health, safety and welfare.

In entering into this Agreement, Developer is acting in a purely private capacity as the owner of real property in the County of El Dorado, which property is subject to the jurisdiction of the County.

6.2. No Liability for Acts of Developer.

6.2.1. It is expressly understood that the development of the Project is an undertaking that may create for Developer liability to third parties including, but not limited to, assignees of all or part of this Agreement, buyers and lessees of buildings, building contractors and subcontractors, and suppliers. Developer understands and agrees that the County would not execute this Agreement if, in so doing, it created for the County any liability to any third party. Consequently, Developer, and its successors, heirs and assigns agree to defend, indemnify and hold harmless the County, and its officers, agents, and employees from any claim or injury to person or property arising out of or relating to this Agreement or the operations of Developer in the development of the Project under the terms of this Agreement.

6.2.2. Developer and all successors also agree to and shall hold County and its appointed councils, boards, commissions, officers, agents and employees harmless from any liability, including costs and attorneys' fees, for any challenge to the Agreement, damages or claims for damage for personal injury, including death, and from claims for property damage which may arise from any act or omission of Developer, of its assigns, successors in interest, or its agents, employees, contractors or sub-contractors, pursuant to this Agreement.

6.2.3. Notwithstanding anything in Section 6.3 to the contrary, the County shall have any remedy available to it at law or in equity to enforce the provision of, or to collect damages for, any breach of this Section.

6.3. Duty to Defend Challenges to this Agreement.

6.3.1. The Parties recognize that there may be third party challenges to this Agreement, relative to the procedure used to adopt it or the contents of it.

6.3.2. Developer shall defend the County and its elective and appointive councils, boards, commissions, officers, agents and employees from any suits or actions at law or in equity for damage caused by reason of the aforesaid operations under this Agreement.

6.3.3. The County shall have the right, at its sole discretion, to select its own attorneys to defend the County in any action brought by a third party, and Developer hereby agrees to pay the fees and expenses of the attorneys selected.

6.3.4. The County agrees to cooperate in good faith in the defense of any action or proceeding brought to challenge this Agreement, the ordinance adopting it, or any of the underlying entitlements.

6.3.5. Should a court, in any action challenging this Agreement or the ordinance adopting it, award attorneys' fees, costs, or other litigation expenses against the County, Developer shall be responsible for the payment of those fees, costs, and expenses and shall hold the County harmless from any claim thereto.

SECTION 7-MISCELLANEOUS

7.1. Mortgagee Protection. Nothing in this Agreement shall prevent or limit Developer, at its sole discretion, from granting one or more Mortgages encumbering all or a portion of Developer's interest in the Property or portion thereof or improvement thereon as security for one or more loans or other financing, but all of the terms and conditions contained in this Agreement shall be binding upon and effective against and shall run to the benefit of Mortgagee who acquires title or possession to the Property, or any portion thereof, by foreclosure, trustee's sale, deed in lieu of foreclosure or otherwise.

7.2. Signatures. Developer and County represent and warrant that the individuals executing this Agreement have the right, power, legal capacity, and authority to enter into and to execute this Agreement on behalf of the respective legal entities of Developer and County.

7.3. Counterparts. This Agreement may be executed in one or more counterparts, each of which shall be deemed an original, but all of which together shall constitute one and the same instrument.

IN WITNESS WHEREOF, the parties have duly signed this Agreement as of the date first written above.

DEVELOPER:

By: _____
Its: _____

COUNTY:

El Dorado County

By: _____
Its: _____

ATTEST:

By: _____

APPROVED AS TO FORM:

By: _____
County Counsel

Saratoga Estates

Wildland Fire Safe Plan

Prepared for:

Renasci Development



Prepared by:

**CDS Fire Prevention Planning
William F. Draper
Registered Professional Forester
#898
4645 Meadowlark Way
Placerville, CA 95667**

January 12, 2015

Exhibit H

Saratoga Estates

Approved by:

Michael Lilienthal
Michael Lilienthal, DC
Fire Marshal
El Dorado Hills Fire Protection District

1-14-15
Date

Darin McFarlin
Darin McFarlin, FC
Fire Prevention
California Department of
Forestry and Fire Protection

1-14-15
Date

Prepared by:

William F. Draper
William F. Draper
RPF# 898

1 14 15
Date



CONTENTS

I. Purpose..... 4

II. Fire Plan Limitations..... 4

III. Wildfire Fire Safe Plan.....5

 1. Project Description.....5

 2. Project Vegetation (Fuels).....5

 3. Problem Statements.....5

 4. Goals.....6

 5. Wildfire Fire Safe Standard Requirements.....6

 6. Other Fire Safe Requirements.....8

 7. Open Space Guidelines.....9

IV. Appendix

 A. Fuel Treatment in Oak Woodland.....10

 B. Enclosed Deck Guidelines10

 C. Maps.....11-13

 D. Notice of Fire Hazard Inspection.....14

I. PURPOSE AND SCOPE

Communities are increasingly concerned about wildfire safety. Drought years coupled with flammable vegetation and annual periods of severe fire weather insure the potential for periodic wildfires.

The purpose of this plan is to assess the wildfire hazards and risks of the Saratoga Estates development, to identify measures to reduce these hazards and risks and to protect the native vegetation. There are moderate fuel hazards and moderate topography associated with this proposed development both on and adjacent to the project.

The possibility of large fires occurring when the Saratoga Estates project is complete will be reduced. However, small wildfires in the open space areas may occur due to the increase in public uses.

Incorporation of the fire hazard reduction measures into the design and maintenance of the development will reduce the size and intensity of wildfires and help prevent catastrophic fire losses. State and County regulations provide the basic guidelines and requirements for fire safe standard requirements and defensible space around dwellings. This plan builds on these basic rules and provides additional fire hazard reduction measures customized to the topography and vegetation of the development with special emphasis on the interface of homes and wildland fuels.

The scope of the Saratoga Estates Wildland Fire Safe Plan recognizes the extraordinary natural features of the area and designs wildfire safety measures which are meant to compliment and become part of the community design. The Plan contains measures for providing and maintaining defensible space along roads and around future homes. Plan implementation measures must be maintained in order to assure adequate wildfire protection.

Homeowners who live in and adjacent to the wildfire environment must take primary responsibility along with the fire services for ensuring their homes have sufficient low ignitability and surrounding fuel reduction treatment. The fire services should become a community partner providing homeowners with technical assistance as well as fire response. For this to succeed, it must be shared and implemented equally by homeowners and the fire services.

II. FIRE PLAN LIMITATIONS

The Wildland Fire Safe Plan for the Saratoga Estates development does not guarantee that wildfire will not threaten, damage or destroy natural resources, homes or endanger residents. However, the full implementation of the fire safe standard requirements will greatly reduce the exposure of homes to potential loss from wildfire and provide defensible space for firefighters and residents as well as protect the native vegetation. Specific items are listed for homeowner's attention to aid in home wildfire safety.

III. THE SARATOGA ESTATES WILDLAND FIRE SAFE PLAN

1. PROJECT DESCRIPTION

The Saratoga Estates development is located within the unincorporated community of El Dorado Hills and on the western edge of El Dorado Hills at the El Dorado-Sacramento County line on a generally southern facing hillside with slopes up to approximately 20% and lies just north of Highway 50. Saratoga Way will be extended to Empire Ranch to form the southern border. Wilson Way will extend from the north and connect to Saratoga Way. This project will divide APN: 120-070-021 consisting of 121.95 acres into 316 residential lots. There are open space lots surrounding the project area on three sides and running down through the development along the stream channel. There are 3 parks. They are located near the northeast corner and southeast corner along Wilson Way and near the center of the project (Lots C, F, I). The interior roadways going through this development are to be 24' wide curb face to curb face allowing for parking on one side of the street. All the streets shall have rolled curbs. The key topographic feature is the stream channel and riparian zone running from north to south through the project area. The development is on slopes.

Structural fire protection is provided by the El Dorado Hills Fire Department and wildland fire protection by the California Department of Forestry and Fire Protection (CAL FIRE). A fire hydrant system will serve the new area. Water is to be supplied by El Dorado Irrigation District (EID).

2. PROJECT VEGETATION (FUELS)

For wildfire planning purposes the vegetation is classified as follows:

- (a) ground fuels- annual grasses, elderberry, blackberries, cattails, and down limbs (Brush)
- (b) overstory- scattered oaks in the open space on the east side

Light fuel loading is throughout the majority property. The riparian zone along the stream channel has pockets of blackberries and cattails and an occasional willow tree. The Promontory has an open space adjacent to the west border of the development. The open space area surrounding the perimeter is primarily grass and two large oaks and brush along the eastern edge.

3. PROBLEM STATEMENTS

- A. The grass/brush fuels will ignite and have a rapid rate of spread.**
Fire in the grass/brush fuels on the slopes of the development are the most serious wildfire problem for this project.
- B. Risk of fire starts will increase with development.**
The greatest risk from fire ignition will be along roads, in the open space areas and on large lots as human use on these areas increase.
- C. Provisions must be made to maintain all fuel treatments.**

The wildfire protection values of fuel reduction are rapidly lost if not maintained. Annual maintenance by June 1 of each year is necessary.

D. Typical home design and siting often does not recognize adequate wildfire mitigation measures.

A review of many wildfires has conclusively shown that most home losses occur when: (1) there is inadequate clearing of flammable vegetation around a house, (2) roofs are not fire resistant, (3) homes are sited in hazardous locations, (4) firebrand ignition points and heat traps are not adequately protected and (5) there is a lack of water for suppression.

4. GOALS

- A. Modify the continuity of high hazard vegetation fuels.
- B. Reduce the size and intensity of wildfires.
- C. Ensure defensible space is provided around all structures.
- D. Design fuel treatments to minimize tree removal
- E. Ensure fuel treatment measures are maintained.
- F. Identify fire safe structural features.
- G. Help homeowners protect their homes from wildfire.

5. WILDLAND FIRE SAFE STANDARD REQUIREMENTS

Wildland fire safe standard requirements are designed to accomplish the Goals by providing and maintaining defensible space and treating high hazard fuel areas. Fire hazard severity is reduced through these fire safe standard requirements. The Wildland Fire Safe Plan places emphasis on defensible space around structures.

Saratoga Estates

A total of 316 lots are planned for this development. There will be a narrow open space along the west side (Lot A) and a portion of the north side (Lot B). There is a large open space on the south side between Saratoga Way and backing up to by residential lots (Lots E, M). Lots J, K and L will be open space along the east side of Wilson Way. There will be a need for nonflammable fencing along all the open space areas that back up to lots. Most of the open space areas are on slopes and have flashy grass fuel. Fuel treatment within the open spaces shall be for the entire open space area. Sidewalks and landscaped front yards will provide for the fuel hazard reduction zones along most of the interior roads. The new streets shall have rolled curbs to provide added width for vehicle passage on the roadway. Streets without sidewalks shall have a fuel hazard reduction zone (FHRZ) of 10'. This zone may incorporate the landscaping of frontyards. All fuel hazard reduction zones shall be annually maintained. The roads shall conform to El Dorado Transportation Division (TD) specifications. The roads are yet to be named.

The stream channel that parallels Wilson Way (Lots B, D) and runs the length of the project area shall have an untreated riparian zone of 20 feet on both sides of the channel. The remaining open space area leading up to the backyards and edge of Wilson Way shall be treated according to Fuel Hazard Reduction (FHRZ) Standards for open space. The FHRZ along the back of all the lots in this development that are adjacent to the open space

shall be the entire width of the open space (Lots A, E, J, K, L) due to the slopes and flashy fuels. Lots C, F and I are to be landscaped.

The project is in a **Moderate Fire Hazard Severity Zone**. All residences shall be required to have NFPA 13D fire sprinkler systems. Implementation of Wildland-Urban Interface Fire Area Building Standards will be required for the construction of new residences. These standards address roofing, venting, eave enclosure, windows, exterior doors, siding, and decking.

Clearance along the road and around structures is very important and necessary. Fire Safe specifications state that all trees in the fuel hazard reduction zones shall be limbed so that branches on the trees are not touching the ground and be pruned up 10 feet as measured on the uphill side of the tree. Grass shall be kept mowed to a 2 inch stubble annually by June 1.

More restrictive standards maybe applied by approving El Dorado County authorities. Approval of this plan does not guarantee approval of this project.

FIRE SAFE STANDARD REQUIREMENTS:

- **Driveways shall be 12 feet wide. Driveways shall comply with the weight and grade standards.**
 - a. **Responsibility- homeowner**
- **All private driveway gates shall be inset on the driveway at least 30 feet from the road. Gate opening shall be 2 feet wider than the driveway. Knox lock assess shall be provided to the fire department.**
 - a. **Responsibility- homeowner**
- **All homes shall have Class A listed roof and assemblies and siding of fire resistant material.**
 - a. **Responsibility- builder/homeowner**
- **Decks that are cantilevered over the natural slope shall be enclosed.**
 - a. **Responsibility- homeowner (See Appendix C for guidelines)**
- **The houses shall be constructed with exterior wall sheathing that shall be rated noncombustible.**
 - a. **Responsibility-builder**
- **Windows and glass doors on the sides of the structure shall have tempered glass and fire resistant frames.**
 - a. **Responsibility-builder**
- **Rafter tails shall be enclosed with noncombustible material on the sides of the structure.**
 - a. **Responsibility-builder**
- **Gutters and downspouts shall be noncombustible.**
 - a. **Responsibility-builder**

- Attic and floor vents shall be covered with ¼ inch, or less, noncombustible mesh and horizontal to the ground.
 - a. Responsibility-builder
- The fire department shall review the Wildland Fire Safe Plan within 5 years to determine its adequacy. It may require modification as necessary.
 - a. Responsibility- fire department

6. OTHER FIRE SAFE REQUIREMENTS

- A. A Notice of Restriction shall be filed with the final subdivision map which stipulates that a Wildland Fire Safe Plan has been prepared or if a legal entity, Homeowners Association (HOA) is created the recorded Declaration of Covenants, Conditions and Restrictions (CC&R) shall include the Wildland Fire Safe Plan. The property owners and the HOA shall comply with the requirements of the Wildland Fire Safe Plan.
- B. A copy of the Wildland Fire Safe Plan shall be given to each new landowner within the development.
- C. Each new property owner prior to construction shall be required to contact El Dorado Community Development Agency/Building Division to have the residential fire sprinkler plan approved. All fire sprinkler systems shall be designed and installed by a licensed contractor.
- D. Road improvements and fire hydrants shall be completed prior to the filing of the final map or bonding for the associated improvements through the local agencies.
- E. The project shall meet all the Public Resource Codes 4290 as amended (the 1991 SRA Fire Safe Regulations- Article 2 Access, Article 3 Signing, Article 4 Water, Article 6 Fuels), County and Fire Department ordinances.
- F. The fire hydrant system shall meet the California Fire Code specifications to water volume, pressure and spacing.
- G. The homeowner/property owner is responsible for any future fire safe or building code changes adopted by the State or local authority.
- H. Fuel treatment along subdivision streets and driveways shall have all fuels within 10 feet of the curb of the street treated annually by June 1 (See Appendix A).
- I. The fuel hazard reduction zone along streets may incorporate irrigated landscaping providing the planting is less than 24" in height and has low flammability.
- J. Clearance requirements may be required by El Dorado County at the time of construction.

- K. All roads less than 24 feet wide curb face to curb face shall be posted "No Parking".
- L. Residential construction contractors may be required to submit a parking plan to El Dorado Hills Fire Department to insure off street parking during construction.
- M. Fencing adjacent to open space shall be constructed from nonflammable material.
- N. The El Dorado Hills Fire Department Weed Abatement ordinance shall apply to any vacant lot.

8. OPEN SPACE GUIDELINES

- A. Remove all dead trees and limbs within 100' of all property lines (outer and inner lines).
- B. Remove all dead limbs from live trees that are within 10' of the ground.
- C. Limb all trees within 30' of the property lines at least 10' above the ground as measured on the uphill side of the tree.
- D. The Fuel Hazard Reduction Zone (FHRZ) shall be from the development property line to the residential lot line or the edge of the roadway. It shall also be 20' from the centerline of the stream channel.
- E. Annually by June 1 cut or remove all grass and brush to a 2" stubble within the FHRZ along the property lines adjacent to the residential lots and along streets.
- F. Any trails shall have a 10' fuel hazard reduction zone along each side of the trail. The zone shall be annually maintained by June 1.
- G. Open space areas shall comply with the Weed Abatement Resolution of the Fire District.
- H. All access points to open space shall have rolled curbs and be posted "No Parking" to allow fire vehicle access. A lockable barrier (knock down bollard) may be installed after consultation with the Fire District.
- I. Mature or multi stemmed oaks can present a serious wildfire problem if untreated. Treat the oaks as to the following specifications: (a) remove all dead limbs and stems and (b) cut off green stems at 10' above the ground that arch over and are growing down towards the ground. Measure from the uphill side of the tree to determine the appropriate height.

E. Appendix

APPENDIX A

SARATOGA ESTATES

FUEL TREATMENT SPECIFICATIONS

For

OAK WOODLAND

Within The Designated Fuel Treatment Areas

1. Leave all live trees where possible.
2. Remove all dead trees.
3. Remove all brush.
4. Prune all live trees of dead branches and green branches 10 feet from the ground as measured on the uphill side of the tree, except no more than 1/3 of the live crown is removed. All slash created by pruning must be disposed of by chipping or hauling off site.
5. Annually by June 1, reduce the grass or weeds to a 2 inch stubble by mowing, chemical treatment, disking or a combination of treatments.

APPENDIX B

SARATOGA ESTATES

ENCLOSED DECK GUIDELINES

The purpose of enclosing the underside of decks that are cantilevered out over the natural slope is to help prevent heat traps and fire brands from a wildfire igniting the deck or fuels under the deck.

1. Does not apply to decks that are constructed using fire resistant materials such as concrete, steel, stucco etc.
2. Any deck shall not include non fire rated composite deck material.
3. This applies to decks one story or less above natural slopes.
4. Combustible material must not be stored under the deck.

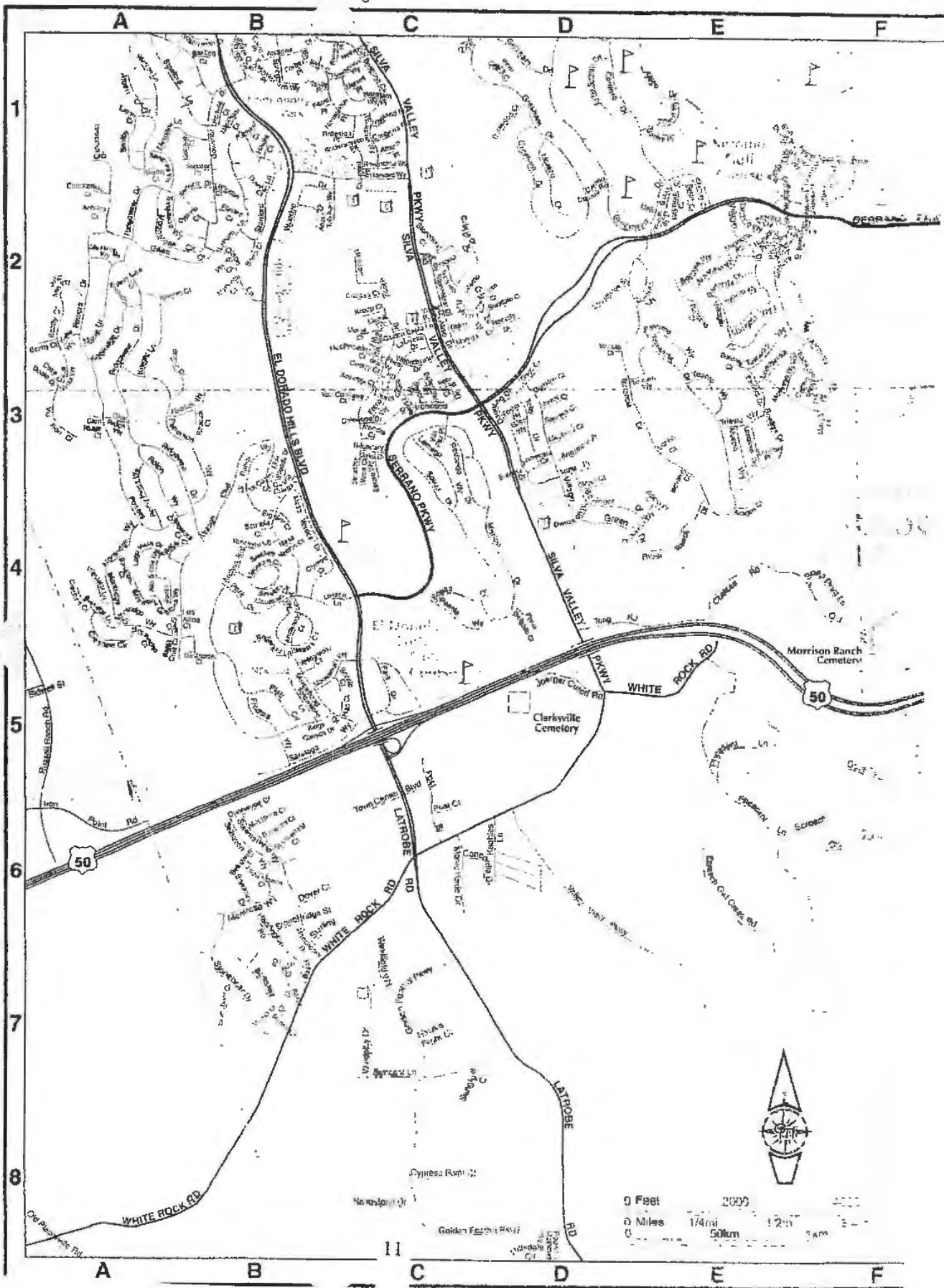

APN 12007002



Aerials Copyright 2003,2004,2008,2007,2011 All Rights Reserved

Disclaimer: This depiction was compiled from unverified public and private sources and is illustrative only. No representation is made as to accuracy of this information. Parcel boundaries are particularly unreliable. Users make use of this depiction at their own risk.

Printed on 4/21/2014 from El Dorado County Surveyor's Office



12

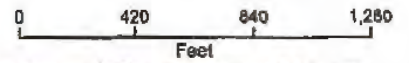

Map displayed in State Plane Coordinate System (NAD 1983 California Zone 2, feet)

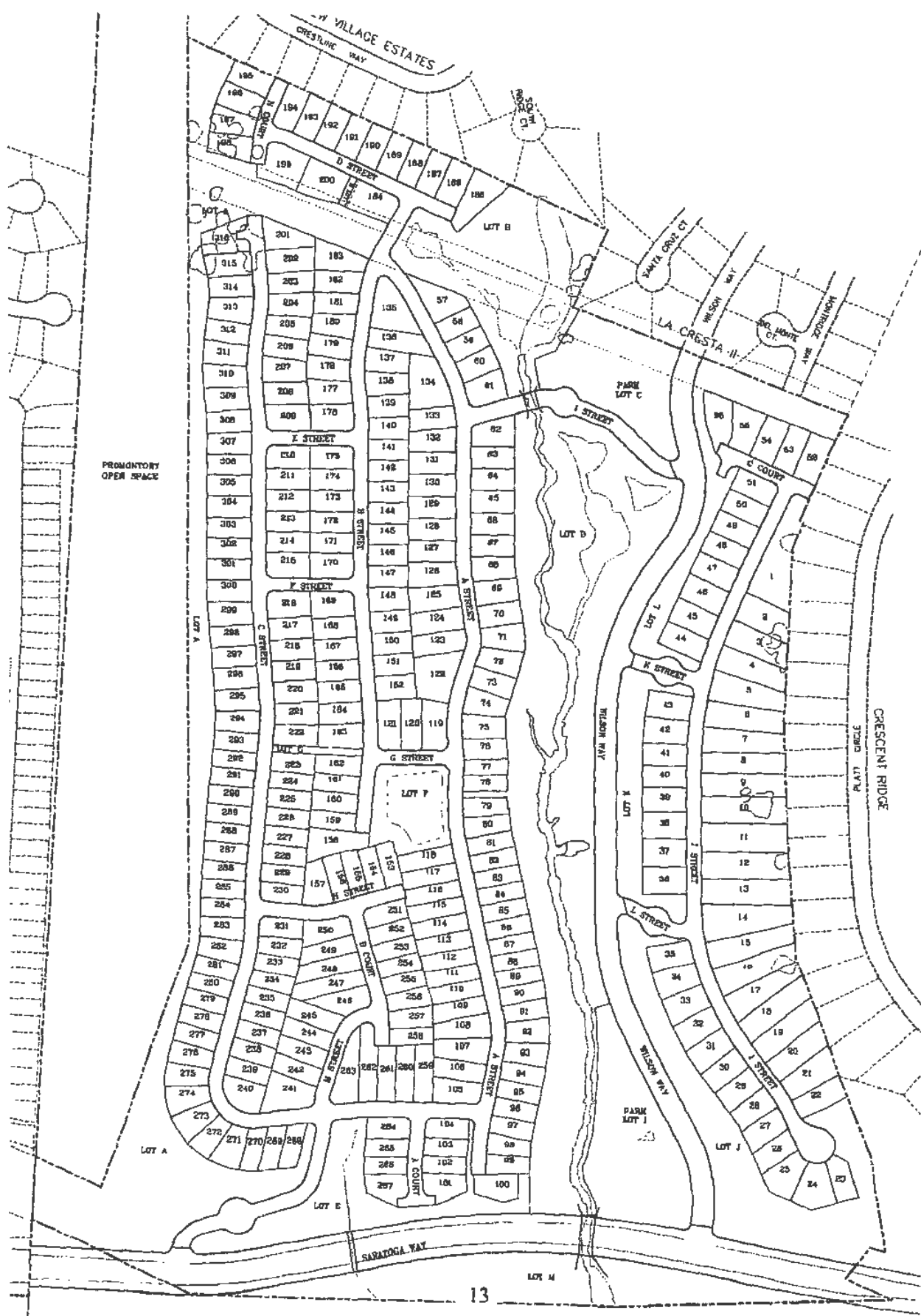

PROMONTORY
OPEN SPACE



State of California
Department of Forestry and Fire Protection

NOTICE OF FIRE HAZARD INSPECTION

A representative from CAL FIRE has inspected your property for fire hazards. You are hereby notified to correct the violation(s) indicated below. Failure to correct these violations may result in a citation and fine.

Occupant:		Physical Address:			Phone #:	
Occupant Not Home: 1 st Attempt: / /	Occupant Not Home: 2 nd Attempt: / /	Refused Inspection: / /	For Questions, Contact Inspector at: () -		Battalion #:	
Roof Construction Combustible/Non-Combustible	Exterior Siding Combustible/Non-Combustible	Window Panes Single Pane/Double Pane	Eaves Enclosed/Unenclosed	Decks or Porches Masonry/Composite/Wood	Location of Structure Flat Ground/Slope/Ridge Top	

- Checked boxes indicate violations.

Corrected

 - 2 3 A. Remove leaves, needles or other vegetation on roofs, gutters, decks, porches and stairways etc. PRC §4291(a)(6)
 - 2 3 B. Remove all dead trees, shrubs or other plants adjacent to or overhanging buildings. PRC §4291(a)(5)
 - 2 3 C. Remove all dead or dying branches and stems from trees, shrubs or other plants adjacent to or overhanging buildings. PRC §4291(a)(4)
 - 2 3 D. Remove all branches within 10 feet of any stovepipe or chimney outlet. PRC §4291(a)(4)
 - 2 3 E. Remove all dead or dying grass, leaves, needles or other vegetation. PRC §4291(a)(1)
 - 2 3 F. Remove or isolate live flammable ground cover and shrubs (i.e. Bear Clover, Mountain Misery, Juniper etc.). PRC §4291(a)(1)

Reduced Fuel Zone (within 30 - 100 feet of all structures or to property line):

 - 2 3 G. Mow dead or dying grass to a maximum of 4 inches in height. Trimmings may remain on the ground. PRC §4291(a)(1)
 - 2 3 H. Live flammable ground cover less than 18 inches in height (i.e. Mountain Misery, Bear Clover etc.) may remain, but overhanging and adjacent trees must be pruned up to 15 feet. PRC §4291(a)(1)
 - 2 3 I. Reduce fuels in accordance with the Continuous Tree Canopy Standard (see back). PRC §4291(a)(1)
 - 2 3 J. Reduce fuels in accordance with the Horizontal Spacing Standard (see back). PRC §4291(a)(1)

Defensible and Reduced Fuel Zone (within 100 feet of all structures or to property line):

 - 2 3 K. Logs or stumps embedded in the soil must be removed or isolated from structures and other vegetation. PRC §4291(a)(1)
 - 2 3 L. Remove all dead or dying brush, trees and branches within 15 feet of the ground. PRC §4291(a)(1)

Other Requirements:

 - 2 3 M. Clear dead, dying or flammable vegetation within 10 feet around and above propane tanks. CFC §3887.3
 - 2 3 N. Address numbers shall be displayed in contrasting colors (4" Min. Size) and readable from the street or access road. CFC §505.1

Recommendations:

 - Cover all chimney or stovepipe openings with a metal screen having openings no larger than 1/2 inch.
 - Clear 10 feet around and 15 feet above fuels (i.e. Woodpiles, lumber, scrap etc.). Move woodpiles as far as possible from structures.
 - Remove flammable materials stored under decks and similar overhangs of structures.
 - Clear vegetation 10 feet from sides and 15 feet above all driveways and turnaround areas.

Comments:

Additional Information on Back

Complete only if occupant contacted

1. Inspector: _____	Date: ___/___/___	A re-inspection will occur on/after: ___/___/___
2. Inspector: _____	Date: ___/___/___	A re-inspection will occur on/after: ___/___/___
3. Inspector: _____	Date: ___/___/___	

Continuous Tree Canopy Standard

To achieve defensible space while keeping a larger stand of trees with a continuous tree canopy, adhere to the guidelines below:

- Prune lower branches of trees to a height of 6 to 15 feet from the top of the vegetation below or 1/3 to 1/2 the tree height for trees under 30 feet, whichever is less.
- Remove all ground fuels greater than four inches in height. Single specimens of trees or other vegetation may be kept if they are well spaced, well pruned and create an overall condition that avoids the spread of fire to other vegetation or to structures.

Horizontal Spacing Standard

- Ideally, grass should not exceed four inches in height. In situations where these fuels are isolated from other fuels or where necessary to stabilize soil, grasses may reach a height of 18 inches.
- Clearance between shrubs should be 4 to 40 feet depending on the slope of the land and size and type of vegetation. Check the chart below for an estimation of clearance distance. Any questions regarding requirements for a specific property should be addressed to your local fire official.

Minimum Horizontal Spacing Guidelines		
Slope	Shrubs, Ground Covers & Other Ornamental Plants Space required between clumps of ground cover, plants, bushes, shrubs, seedlings or sapling trees, etc.	Trees Space required between tree canopies
Flat or gentle slope (0% to 20%)	2 times the height of the plant	10 feet
Moderate slope (20% to 40%)	4 times the height of the plant	20 feet
Steep slope (greater than 40%)	6 times the height of the plant	30 feet

PRC §4291(a) A person who owns, leases, controls, operates, or maintains a building or structure in, upon, or adjoining a mountainous area, forest-covered lands, brush-covered lands, grass-covered lands, or land that is covered with flammable material, shall at all times do all of the following:

(1) Maintain defensible space no greater than 100 feet from each side of the structure, but not beyond the property line unless allowed by state law, local ordinance, or regulation and as provided in paragraph (2). The amount of fuel modification necessary shall take into account the flammability of the structure as affected by building material, building standards, location, and type of vegetation. Fuels shall be maintained in a condition so that a wildfire burning under average weather conditions would be unlikely to ignite the structure. This paragraph does not apply to single specimens of trees or other vegetation that are well-pruned and maintained so as to effectively manage fuels and not form a means of rapidly transmitting fire from other nearby vegetation to a structure or from a structure to other nearby vegetation. The intensity of fuels management may vary within the 100-foot perimeter of the structure, the most intense being within the first 30 feet around the structure. Consistent with fuels management objectives, steps should be taken to minimize erosion.

(2) A greater distance than that required under paragraph (1) may be required by state law, local ordinance, rule, or regulation. Clearance beyond the property line may only be required if the state law, local ordinance, rule, or regulation includes findings that such a clearing is necessary to significantly reduce the risk of transmission of flame or heat sufficient to ignite the structure, and there is no other feasible mitigation measure possible to reduce the risk of ignition or spread of wildfire to the structure. Clearance on adjacent property shall only be conducted following written consent by the adjacent landowner.

(3) An insurance company that insures an occupied dwelling or occupied structure may require a greater distance than that required under paragraph (1) if a fire expert, designated by the director, provides findings that such a clearing is necessary to significantly reduce the risk of transmission of flame or heat sufficient to ignite the structure, and there is no other feasible mitigation measure possible to reduce the risk of ignition or spread of wildfire to the structure. The greater distance may not be beyond the property line unless allowed by state law, local ordinance, rule, or regulation.

(4) Remove that portion of any tree that extends within 10 feet of the outlet of a chimney or stovepipe.

(5) Maintain any tree, shrub, or other plant adjacent to or overhanging a building free of dead or dying wood.

(6) Maintain the roof of a structure free of leaves, needles, or other vegetative materials.

For additional information on how to comply with defensible space clearance requirements, please visit:

WWW.FIRE.CA.GOV

PRELIMINARY GRADING & DRAINAGE PLAN

SARATOGA ESTATES

COUNTY OF EL DORADO

SEPTEMBER, 2014

STATE OF CALIFORNIA



- LEGEND:**
- EXISTING WETLANDS
 - RIGHT OF WAY LINE
 - DAYLIGHT LINE
 - LOT LINE
 - SUBDIVISION BOUNDARY
 - PROPOSED EASEMENT
 - APPROXIMATE SPOT ELEVATION
 - GRADE BREAK
 - OCP/DRAINAGE OUTLET
 - RETAINING WALL
 - SOUND WALL
 - EXISTING TREE CANOPY TO BE REMOVED
 - APPROXIMATE ROADWAY GRADE
 - PAD

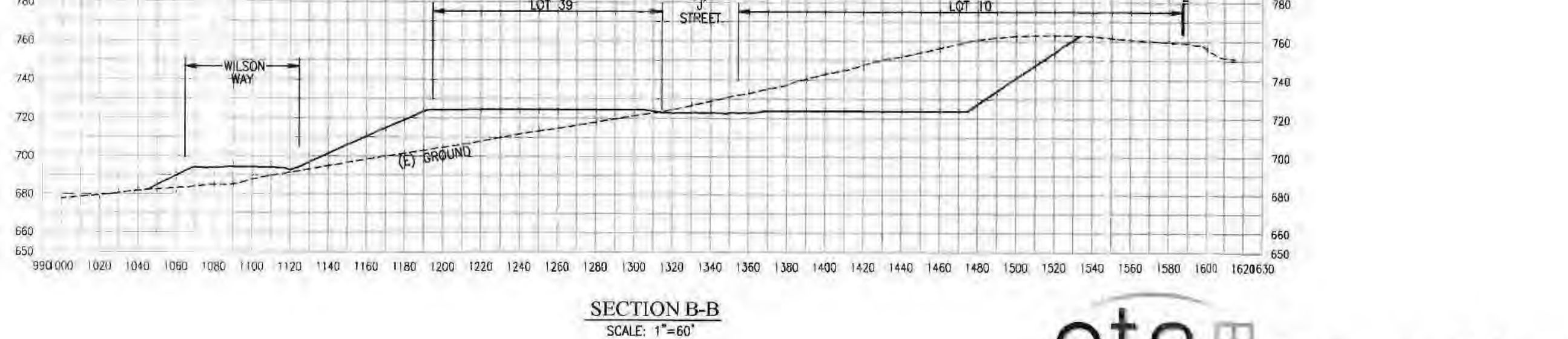
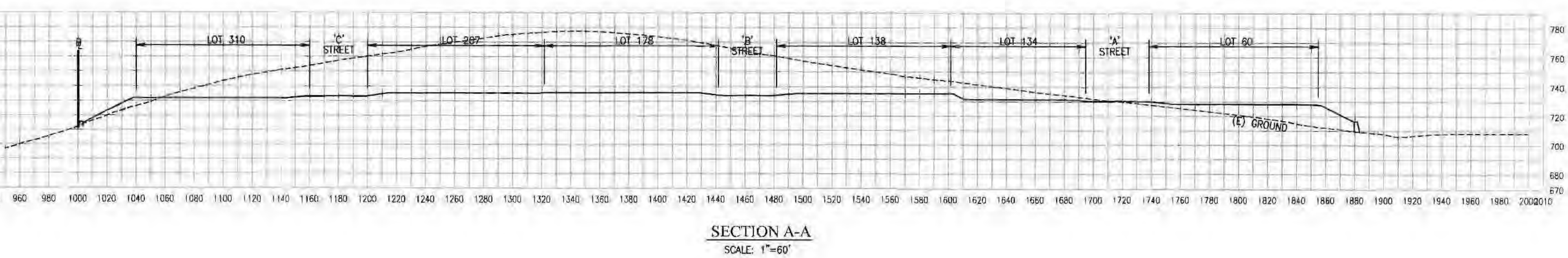
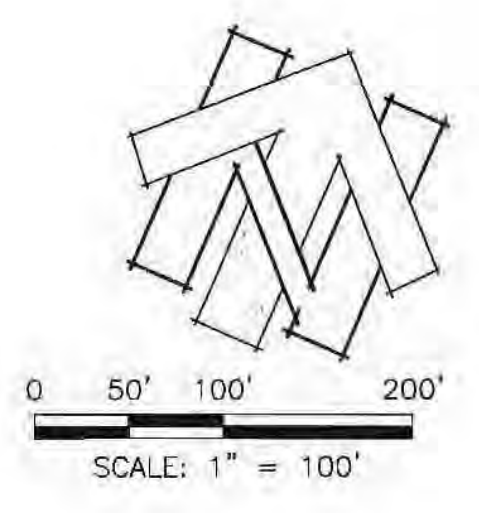

Exhibit I

cta Engineering & Surveying
 Civil Engineering • Land Surveying • Land Planning
 3233 Mosier Circle, Rancho Cordova, CA 95742
 (916) 888-0919 • F (916) 888-2479 • www.cta.net

SARATOGA ESTATES ZONING EXHIBIT

COUNTY OF EL DORADO, CA
AUGUST, 2016



SCALE: 1"=360'



Engineering & Surveying

Civil Engineering ■ Land Surveying ■ Land Planning
3233 Monier Circle, Rancho Cordova, CA 95742
T (916) 638-0919 ■ F (916) 638-2479 ■ www.ctaes.net

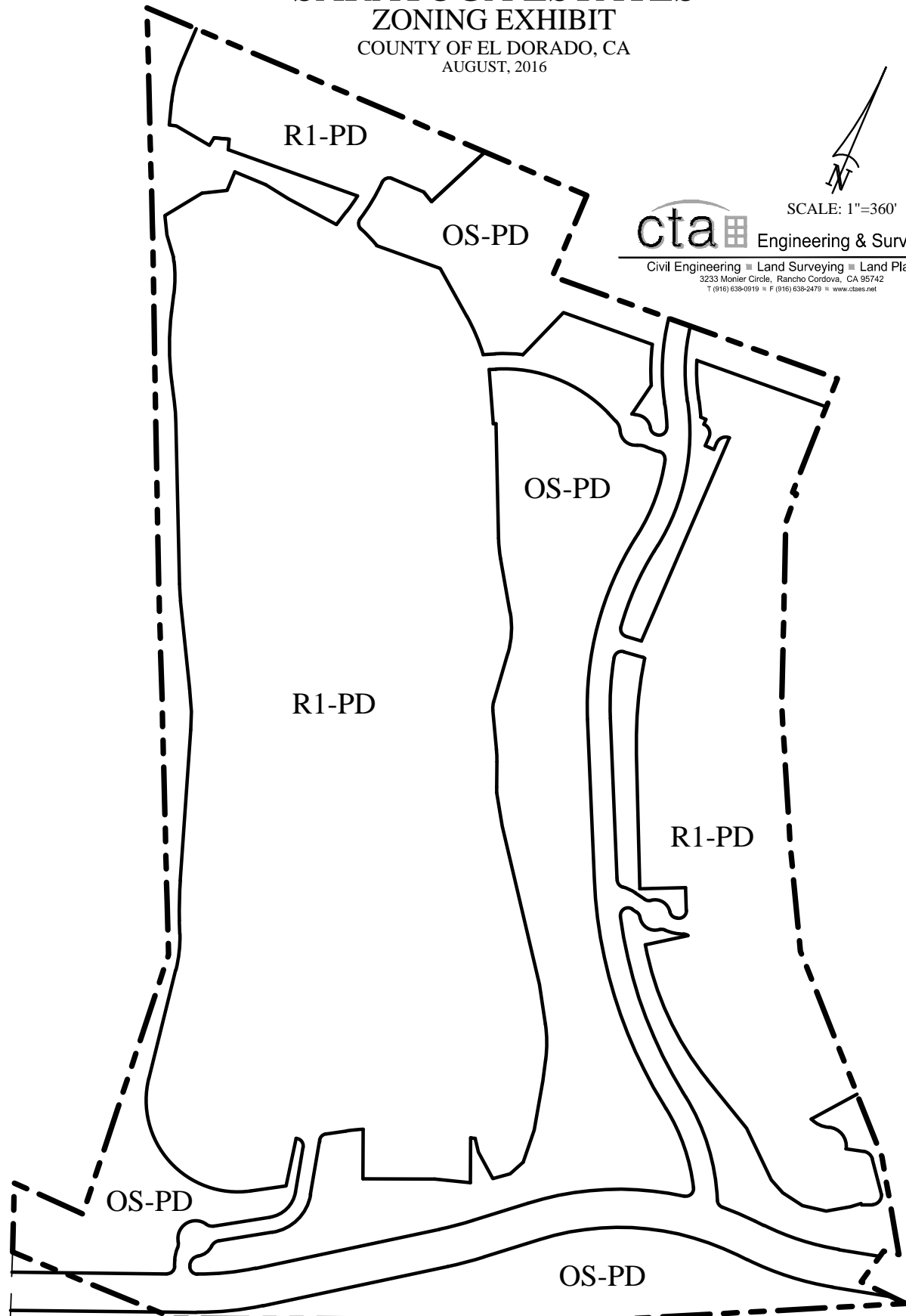

Exhibit J

SARATOGA ESTATES

LINE OF SIGHT EXHIBIT EL DORADO COUNTY, CALIFORNIA

SCALE: 1"=100"

JUNE, 2016

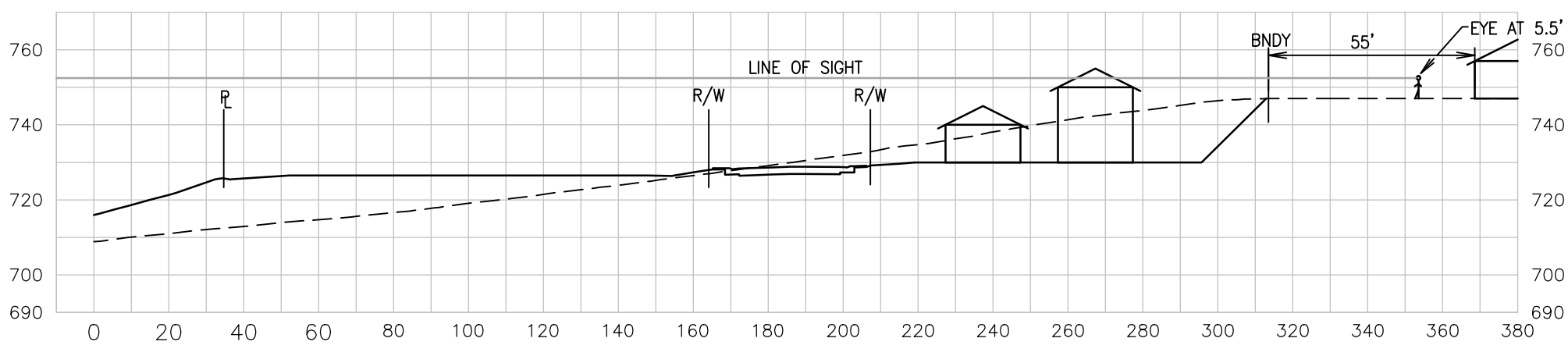
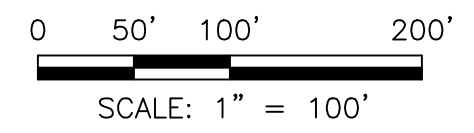
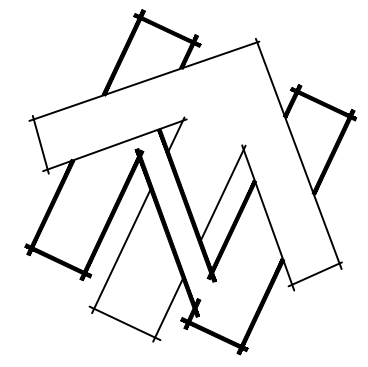

Section View 6
SCALE: 1"=40'

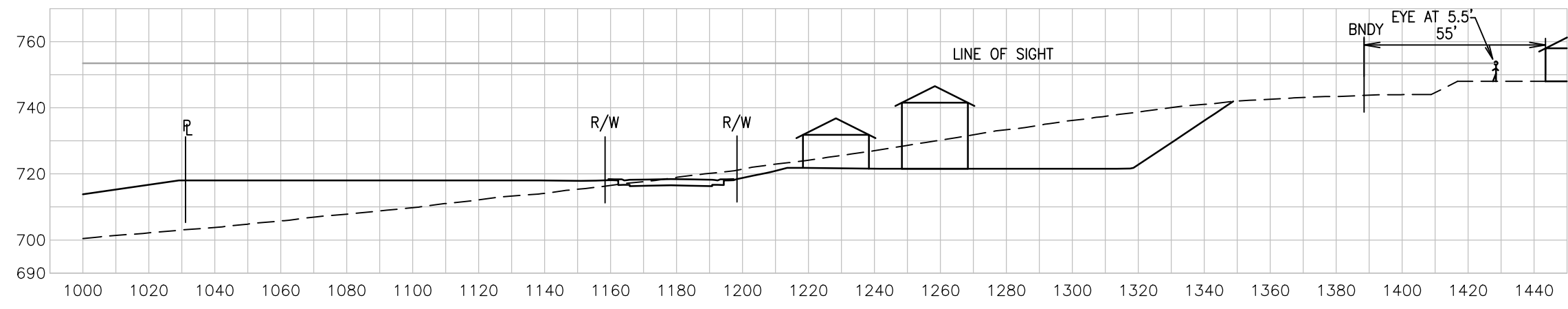

Section View 5
SCALE: 1"=40'

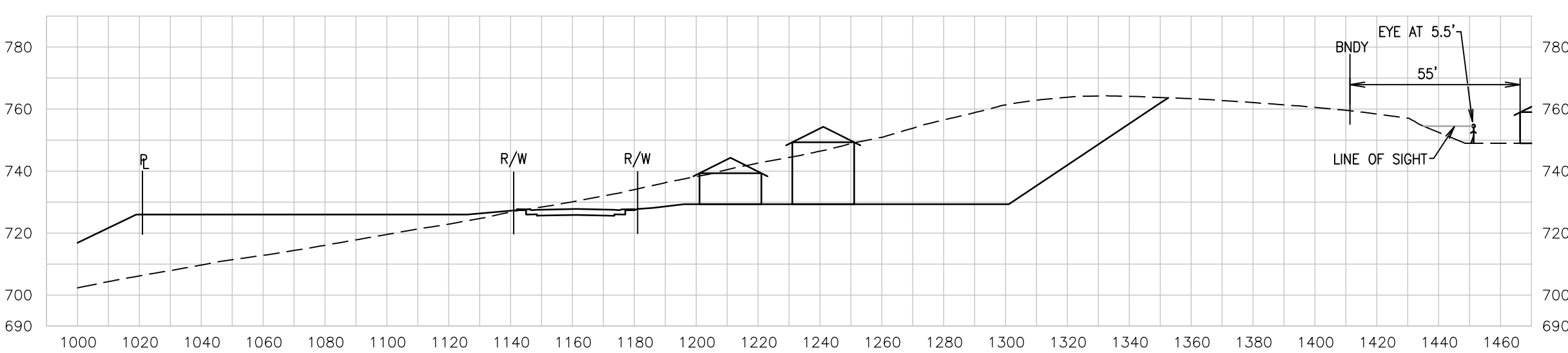

Section View 4
SCALE: 1"=40'

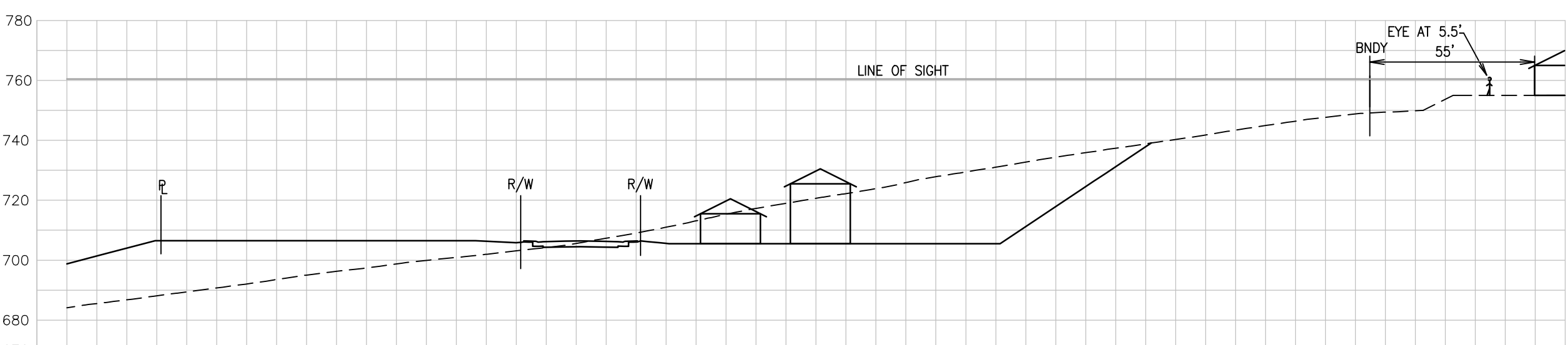

Section View 3
SCALE: 1"=40'

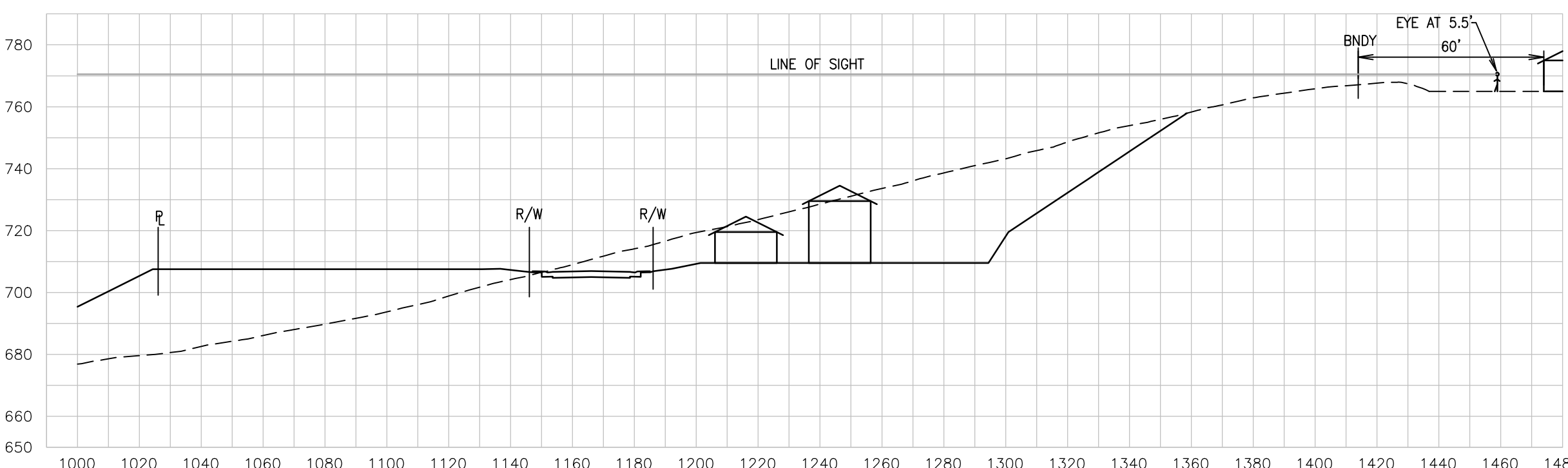

Section View 2
SCALE: 1"=40'

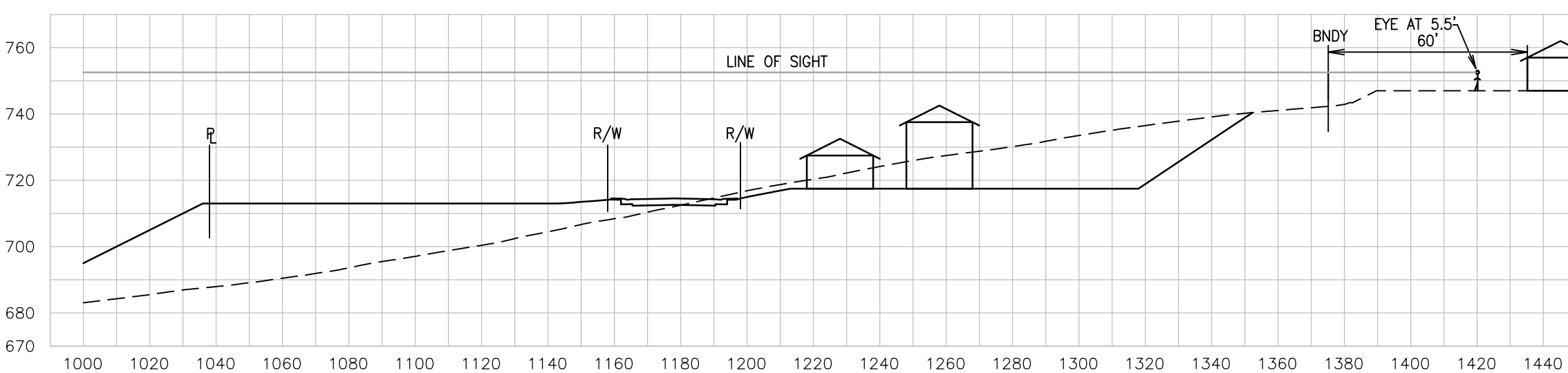

Section View 1
SCALE: 1"=40'

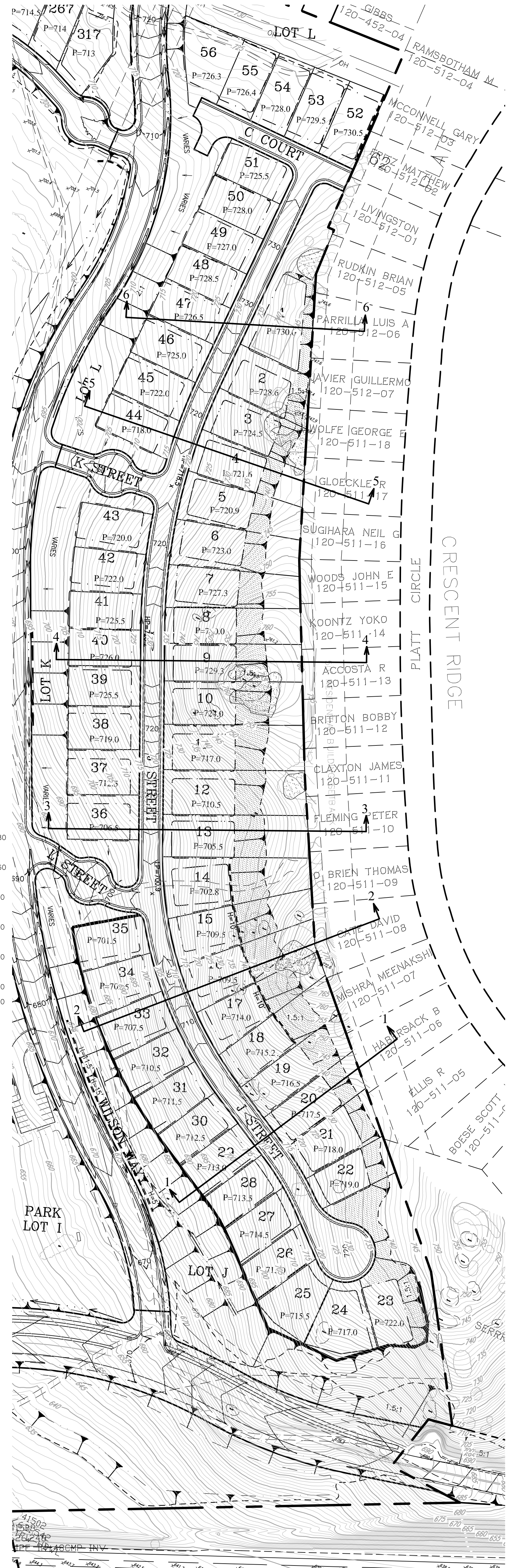

cta Engineering & Surveying
Civil Engineering ■ Land Surveying ■ Land Planning
3233 Monier Circle, Rancho Cordova, CA 95742
T (916) 638-0919 ■ F (916) 638-2479 ■ www.ctaes.net