



PLANNING AND BUILDING DEPARTMENT

PLANNING DIVISION

<https://www.edcgov.us/Government/Planning>

PLACERVILLE OFFICE:

2850 Fairlane Court, Placerville, CA 95667

BUILDING

(530) 621-5315 / (530) 622-1708 Fax

bldgdept@edcgov.us

PLANNING

(530) 621-5355 / (530) 642-0508 Fax

planning@edcgov.us

LAKE TAHOE OFFICE:

924 B Emerald Bay Rd

South Lake Tahoe, CA 96150

(530) 573-3330

(530) 542-9082 Fax

TO: Planning Commission

Agenda of: May 13, 2021

FROM: Evan Mattes, Senior Planner

Item No.: 3

DATE: May 4, 2021

Legistar No.: 21-0733

RE: DR19-0006/Cool General Retail

The purpose of this memorandum is to correct Exhibit K of the Planning Commission staff report containing the Traffic Impact Analysis for Cool Dollar General Store (July 24, 2019) and replace with the attached Traffic Impact Analysis for Cool Dollar General Store (Revised March 9, 2020). Please note that this Traffic Impact Analysis for Cool Dollar General Store (Revised March 9, 2020) is part of the Environmental Impact Report for the project.

ATTACHMENTS:

Exhibit K Traffic Impact Analysis March 9 2020

TRAFFIC IMPACT ANALYSIS
FOR
COOL DOLLAR GENERAL STORE
El Dorado County, California

Prepared For:

WoodCrest Companies
1410 Main Street, Suite C
Ramona, CA 92065

Prepared By:

KD Anderson & Associates, Inc.
3853 Taylor Road, Suite G
Loomis, CA 95650
(916) 660-1555



Revised March 9, 2020
July 24, 2019

Job No. 9470-02

Cool Dollar General

KD Anderson & Associates, Inc.

Transportation Engineers
21-0733 N 2 of 150

**TRAFFIC IMPACT ANALYSIS FOR
COOL DOLLAR GENERAL STORE**
El Dorado County, California

TABLE OF CONTENTS

INTRODUCTION.....	1
Project Description	1
EXISTING SETTING	4
Study Area Circulation System - Roads	4
Study Area Intersections	4
Standards of Significance: Levels of Service - Methodology	5
Existing Traffic Volumes / Levels of Service	9
Collision History	13
Alternative Transportation Modes	13
Regulatory Setting	13
PROJECT CHARACTERISTICS	14
Trip Generation.....	14
Vehicle Trip Distribution / Assignment	15
PROJECT TRAFFIC IMPACTS.....	17
Existing Plus Project Traffic Conditions and Levels of Service	17
Project Impacts to Alternative Transportation Modes.....	20
Site Access.....	20
CUMULATIVE IMPACTS	22
Year 2040 Long Term Cumulative Conditions	22
SUMMARY AND CONCLUSIONS	28
APPENDIX.....	30

**TRAFFIC IMPACT ANALYSIS FOR
COOL DOLLAR GENERAL STORE**
El Dorado County, California

INTRODUCTION

This report documents **KD Anderson & Associates'** analysis of the traffic impacts associated with developing a Dollar General Store in the rural El Dorado County community of Cool, California. This assessment of traffic impacts has been required by Caltrans District 3. The analysis identifies both current and future background conditions at key intersections in the vicinity of the site. To assess traffic impacts, the characteristics of the proposed project have been determined, including estimated trip generation and the directional distribution / assignment of project generated traffic. The extent of off-site impacts has been determined, and the adequacy of site access has been evaluated.

Project impacts have been quantified at the following study intersections:

1. SR 49/ St Florian Ct
2. SR 49/ Northside Dr
3. SR 49/ Commercial Driveway (south of Northside Drive)
4. SR 49/ SR 193
5. USPS Driveway/ Northside Dr
6. Project Driveway/ Northside Dr

Project Description

The proposed project consists of a 9.1 ksf Dollar General Store located on an approximately 1.68 acre site on the south side of Northside Drive about 190 feet east of SR 49 (centerline to centerline). The project will include development of 31 parking spaces per El Dorado County Zoning Ordinance requirements. Access to the site will be provided via a single driveway on Northside Drive. The driveway is about 35 feet from the USPS Driveway to the west and is about 655 feet from the Cool Boat and RV Storage across Northside Drive to the east. The project's Northside Drive frontage is currently unimproved, and other than access improvements development of the project will not include any other improvements along the Northside Drive frontage. Figures 1 and 2 display the regional location of the project and proposed site plan, respectively.



VICINITY MAP

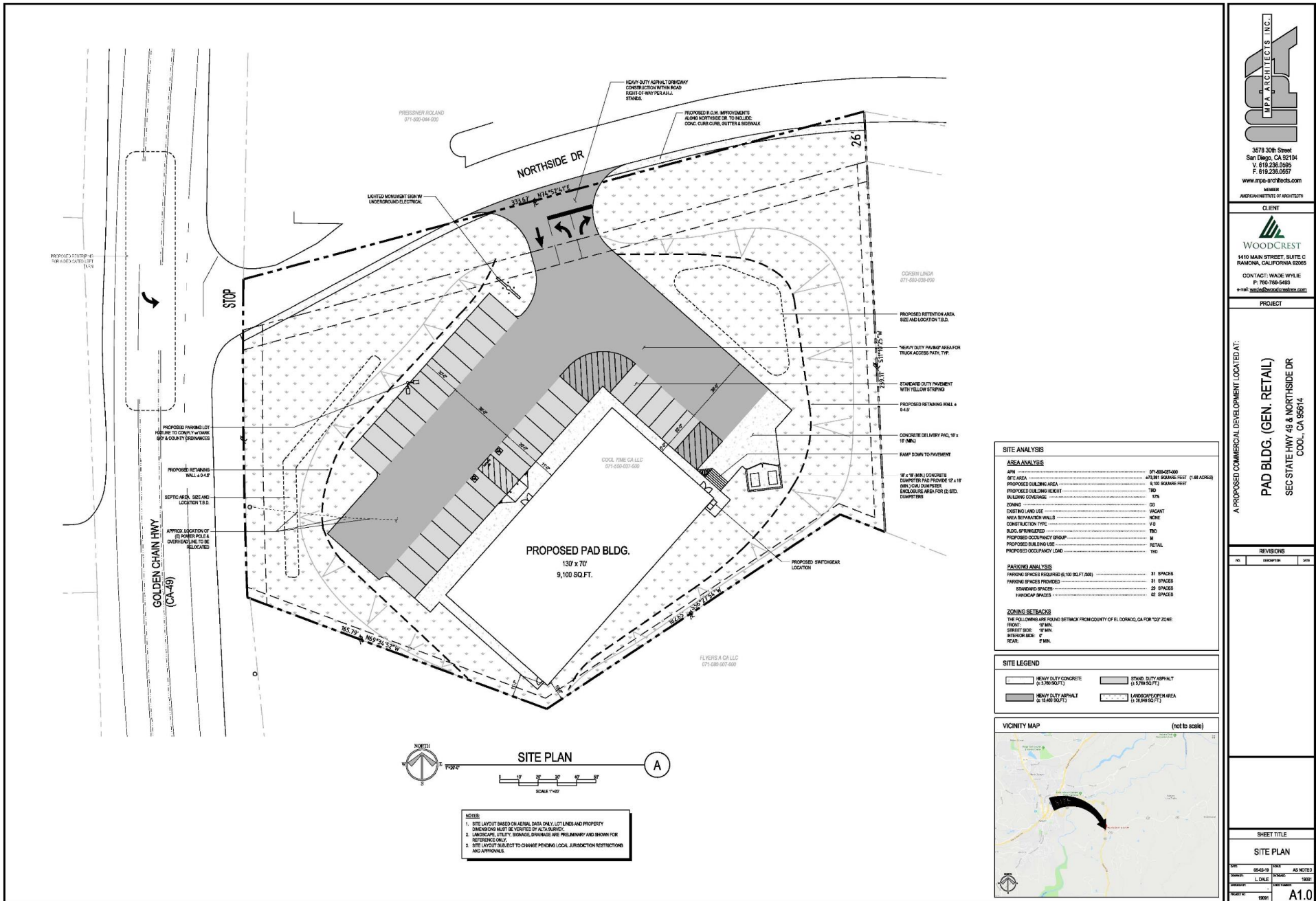

SITE ANALYSIS

AREA ANALYSIS

APN	071-000-087-000
SITE AREA	27,000 SQUARE FEET (1.88 ACRES)
PROPOSED BUILDING AREA	8,100 SQUARE FEET
PROPOSED BUILDING HEIGHT	TBD
BUILDING COVERAGE	10%
ZONING	OS
EXISTING LAND USE	VACANT
AREA REZONATION WALLS	NONE
CONSTRUCTION TYPE	V-B
SLAB FINISHES	TBD
PROPOSED OCCUPANCY GROUP	M
PROPOSED BUILDING USE	RETAIL
PROPOSED OCCUPANCY LOAD	TBD

PARKING ANALYSIS

PARKING SPACES REQUIRED (0.150 SQ.FT./SPACE)	31 SPACES
PARKING SPACES PROVIDED	31 SPACES
REMARKS SPACES	29 SPACES
HANDICAP SPACES	02 SPACES

ZONING SETBACKS

THE FOLLOWING ARE FOUND SETBACK FROM COUNTY OF EL DORADO, CA FOR 'OS' ZONE:

FRONT	10' MIN.
STREET SIDE	10' MIN.
INTERIOR SIDE	0' MIN.
REAR	0' MIN.

SITE LEGEND

	HEAVY DUTY CONCRETE (0.3,290 SQ.FT.)
	HEAVY DUTY ASPHALT (0.3,140 SQ.FT.)
	STAND DUTY ASPHALT (1,370 SQ.FT.)
	LANDSCAPE/GRASS AREA (1,304 SQ.FT.)

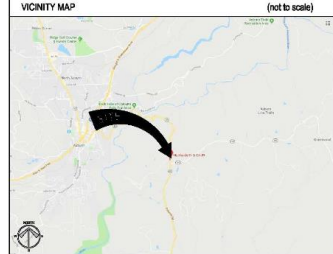

NOTES:

1. SITE LAYOUT BASED ON AERIAL DATA ONLY. LOT LINES AND PROPERTY DIMENSIONS MUST BE VERIFIED BY A SURVEYOR.
2. LANDSCAPE, UTILITY, DRAINAGE, SWANAGE ARE PRELIMINARY AND SHOWN FOR REFERENCE ONLY.
3. SITE LAYOUT SUBJECT TO CHANGE PENDING LOCAL JURISDICTION RESTRICTIONS AND APPROVALS.

MPA ARCHITECTS, INC.

3678 30th Street
San Diego, CA 92104
V 619.236.0595
F 619.236.0557
www.mpa-architects.com

CLIENT

WOODCREST

1410 MAIN STREET, SUITE C
RAMONA, CALIFORNIA 92265

CONTACT: WADE WYLLIE
P: 760-766-5492
www.wyilliearchitects.com

PROJECT

PAD BLDG. (GEN. RETAIL)
SEC STATE HWY 48 & NORTHSIDE DR
COOL, CA 92614

REVISIONS

NO.	DESCRIPTION	DATE

SHEET TITLE

SITE PLAN

DATE	05-20-20	SCALE	AS NOTED
DRAWN BY	L. DALE	DATE	1900
CHECKED BY		DATE	
DATE		SCALE	

A1.0

EXISTING SETTING

This report section describes the facilities that are available today serving vehicular, pedestrian and bicycle traffic and transit users in El Dorado County, as well as policies that guide consideration of traffic impacts.

Study Area Circulation System - Roads

The text which follows provides information regarding the streets included in the study area.

State Route 49 (SR 49) serves north-south traffic throughout the Sierra Nevada foothills. In and near El Dorado County, State Route 49 runs from Plymouth in Amador County through Diamond Springs, Placerville, Coloma, Pilot Hill, and Cool to Auburn in Placer County. The portion of State Route 49 between Cool and Auburn contains sections that are narrow, winding, and steep. In the vicinity of the site, SR 49 is a 2-lane facility with no frontage improvements. The posted speed limit is 45 mph near the site and transitions to 55 mph further north. The most recent traffic volume counts published by Caltrans indicate that SR 49 carries an Annual Average Daily Traffic (AADT) volume of 8,800 vehicles per day north of SR 193, and trucks comprise 4% of the daily volume.

Northside Drive is a 2-lane Local street that intersects State Route 49 approximately 600 feet north of SR 193.

State Route 193 (SR 193) runs easterly from SR 49 in Cool to an intersection on SR 49 north of Placerville. The two-lane highway is generally far narrower than the Caltrans standard for this type of highway, except for a wider section near Georgetown and a narrower, steep, and winding section north of Placerville. In the vicinity of the site, SR 193 is a 2-lane facility with no frontage improvements, although a separated bike path exists along the northside of the road. The posted speed limit is 55 mph. The most recent traffic volume counts published by Caltrans indicate that SR 193 carries 7,600 AADT east of SR 49, and trucks comprise 6% of the daily volume.

Study Area Intersections

The quality of traffic flow is often governed by the operation of key intersections. The following intersections have been identified for evaluation in this study in consultation with El Dorado County and Caltrans staff.

The **State Route 49 / St Florian Court intersection** is a “Tee” intersection controlled by an eastbound stop sign on St Florian Court. A northbound left turn lane is present on SR 49. The St Florian Court approach is a single lane, and there are no crosswalks present.

The **State Route 49 / Northside Drive intersection** is a “Tee” intersection controlled by a westbound stop sign on Northside Drive. A Two-Way-Left-Turn-Lane is present on SR 49. The Northside Drive approach is a single lane, and there are no crosswalks present.

The **State Route 49 / Commercial Driveway intersection** is a “Tee” controlled by a stop sign on eastbound Commercial Driveway. A Two-Way-Left-Turn-Lane is present on SR 49. The Commercial Driveway is a private drive, and there are no crosswalks present.

The **State Route 49 / State Route 193 intersection** is a four-way intersection controlled by an all-way stop with an overhead flasher. SR 49 has separate left turn lanes on each approach. A southbound right turn lane exists, and the northbound thru lane is wide enough to allow right turns outside of the queue of northbound traffic. The SR 193 westbound approach is wide enough to act as a combined left-thru lane and a separate right turn lane, and the eastbound leg is a single lane private drive. Crosswalks exist on the south and east side of the intersection.

The **USPS Driveway / Northside Drive intersection** is a “Tee” controlled by a stop sign on the southbound USPS Driveway. There are no auxiliary lanes or crosswalks present.

Standards of Significance: Levels of Service - Methodology

To assess the quality of existing traffic conditions, Levels of Service were calculated at study area intersections and for individual roadway segments. "Level of Service" is a qualitative measure of traffic operating conditions whereby a letter grade "A" through "F", corresponding to progressively worsening traffic operating conditions, is assigned to an intersection or roadway segment. Table 1 presents the characteristics associated with each LOS grade. As shown in Table 1, LOS "A", "B" and "C" are considered satisfactory to most motorists, while LOS "D" is marginally acceptable. LOS "E" and "F" are associated with severe congestion and delay and are unacceptable to most motorists.

Local agencies and Caltrans adopt minimum Level of Service standards for their facilities. El Dorado County identifies LOS E as the acceptable Level of Service for roadway segments and intersections on County roadways and state highways within the unincorporated areas of the County in the Community Regions and LOS D in the Rural Centers and Rural Regions except as specified in the General Plan. The analysis techniques presented in the *Highway Capacity Manual, 6th Edition* were used to calculate Level of Service and to provide a basis for describing existing traffic conditions and evaluating the significance of project traffic impacts.

The SR 49 Transportation Concept Report indicates that the ultimate Concept Level of Service is LOS D, while LOS D is the expectation for SR 193.

**TABLE 1
LEVEL OF SERVICE DEFINITIONS**

Level of Service	Signalized Intersection	Unsignalized Intersection	Roadway (Daily)
"A"	Uncongested operations, all queues clear in a single-signal cycle. Ave Delay \leq 10 seconds per vehicle	Little or no delay. Ave Delay \leq 10 sec/veh	Completely free flow.
"B"	Uncongested operations, all queues clear in a single cycle. Delay $>$ 10 sec/veh and \leq 20 sec/veh	Short traffic delays. Delay $>$ 10 sec/veh and \leq 15 sec/veh	Free flow, presence of other vehicles noticeable.
"C"	Light congestion, occasional backups on critical approaches. Delay $>$ 20 sec/veh and $<$ 35 sec/veh	Average traffic delays. Delay $>$ 15 sec/veh and \leq 25 sec/veh	Ability to maneuver and select operating speed affected.
"D"	Significant congestions of critical approaches but intersection functional. Cars required to wait through more than one cycle during short peaks. No long queues formed. Delay $>$ 35 sec/veh and $<$ 55 sec/veh	Long traffic delays. Delay $>$ 25 sec/veh and \leq 35 sec/veh	Unstable flow, speeds and ability to maneuver restricted.
"E"	Severe congestion with some long standing queues on critical approaches. Blockage of intersection may occur if traffic signal does not provide for protected turning movements. Traffic queue may block nearby intersection(s) upstream of critical approach(es). Delay $>$ 55 sec and \leq 80 sec/veh	Very long traffic delays, failure, extreme congestion. Delay $>$ 35 sec/veh and \leq 50 sec/veh	At or near capacity, flow quite unstable.
"F"	Total breakdown, stop-and-go operation. Delay $>$ 80 sec/veh	Intersection often blocked by external causes. Delay $>$ 50 sec/veh	Forced flow, breakdown.

Sources: Highway Capacity Manual, 6th Edition, and Transportation Research Board (TRB) Special Report 209.

Level of Service Methods at Intersections. Levels of Service were calculated for different intersection control types using the respective methods presented in the Highway Capacity Manual, 6th Edition (HCM 6 Ed) using SYNCHRO 10.0 software. For intersections controlled by side street stop signs, the reported Level of Service reflects the “worst case” movement, which is typically those motorists waiting to enter the main street.

Traffic Signal Warrants. The extent to which a traffic signal may be justified is determined based on many factors. From the standpoint of traffic impact analysis, signal warrant criteria contained in the *California Manual of Uniform Traffic Control Devices (CA MUTCD)* are employed in order to assess the relative impact of the additional traffic accompanying a development proposal. For this analysis, Warrant 3 (Peak Hour Traffic) has been employed. Variation in warrant requirements occur based on the design speed of the road (i.e., $>$ 40 mph)

and on the location of the intersection (i.e., rural versus urban locations). In this case, rural criteria for roadway speeds above 40 mph have been employed. It is also important to note that other warrants addressing factors such as pedestrian activity and collision history are necessarily considered before a decision is made to install a traffic signal.

Two-Lane Roadway Segment Levels of Service. Two-lane roadways were analyzed using methods presented in the *Highway Capacity Manual 2010 (HCM)*.

HCM Classifications. A two-lane highway is an undivided roadway with one lane in each direction. Passing a slower vehicle requires use of the opposing lane as sight distance and gaps in the opposing traffic stream permit. As volumes and geometric restrictions increase, the ability to pass decreases and platoons form. Motorists in platoons are subject to delay because they are unable to pass. The HCM divides these roadways into three types: Class I, Class II and Class III. They are defined as follows:

- *Class I two-lane highways* are highways where motorists expect to travel at relatively high speeds. Two-lane highways that are major intercity routes, primary connectors of major traffic generators, daily commuter routes, or major links in state or national highway networks are generally assigned to Class I. These facilities serve mostly long-distance trips or provide the connections between facilities that serve long-distance trips.
- *Class II two-lane highways* are highways where motorists do not necessarily expect to travel at high speeds. Two-lane highways functioning as access routes to Class I facilities, serving as scenic or recreational routes (and not as primary arterials), or passing through rugged terrain (where high-speed operation would be impossible) are assigned to Class II. Class II facilities most often serve relatively short trips, the beginning or ending portions of longer trips, or trips for which sightseeing plays a significant role.
- *Class III two-lane highways* are highways serving moderately developed areas. They may be portions of a Class I or Class II highway that pass through small towns or developed recreational areas. On such segments, local traffic often mixes with through traffic, and the density of unsignalized roadside access points is noticeably higher than in a purely rural area. Class III highways may also be longer segments passing through more spread-out recreational areas, also with increased roadside densities. Such segments are often accompanied by reduced speed limits that reflect the higher activity level.

Measures of Effectiveness. Three measures of effectiveness are incorporated into the methodology to determine LOS on roadway segments:

1. *Average Travel Speed (ATS)* reflects mobility on a two-lane highway. It is defined as the highway segment length divided by the average travel time taken by vehicles to traverse it during a designated time interval.

2. *Percent Time Spent Following (PTSF)* represents the freedom to maneuver and the comfort and convenience of travel. It is the average percentage of time that vehicles must travel in platoons behind slower vehicles due to the inability to pass. Because this characteristic is difficult to measure in the field, a surrogate measure is the percentage of vehicles traveling at headways of less than 3.0 at a representative location within the highway segment. PTSF also represents the approximate percentage of vehicles traveling in platoons.

3. *Percent of free-flow speed (PFFS)* represents the ability of vehicles to travel at or near the posted speed limit.

Speed and delay due to passing restrictions are both assumed to be important to motorists on Class I two-lane highways, and therefore, LOS is defined in terms of both ATS and PTSF on these facilities. Travel speed is not necessarily a significant issue on Class II highways, and LOS is defined in only terms of PTSF on these highways. High speeds are not expected on Class III highways, and since the length of the Class III segments may generally be limited, passing restrictions are also not a major concern. On Class III segments drivers are expected to want to travel at or near the speed limit. Therefore, PFFS is used to define LOS for Class III roads. The LOS criteria for two-lane highways within these three measures are shown in Table 2.

**TABLE 2
LOS THRESHOLD FOR TWO-LANE HIGHWAYS**

LOS	Class I Highways		Class II Highways	Class III Highways
	ATS (mi / hr)	PTSF (%)	PTSF (%)	PFFS (%)
A	>55	≤35	≤40	>91.7
B	>50-55	>35-50	>40-55	>83.3 – 91.7
C	>45-50	>50-65	>55-70	>75.0 – 83.3
D	>40-45	>65-80	>70-85	>66.7 – 75.0
E	≤40	>80	>85	≤66.7

Source: HCM 2010, Chapter 15, December 2010

Standards of Significance. El Dorado County guidelines identify criteria for determining the significance of traffic impacts. A traffic impact is considered to be significant under El Dorado County guidelines if the project causes an intersection to change from LOS D to LOS E. Worsening of conditions at facilities already operating at unacceptable levels of service is also considered a significant impact. The County’s General Plan Policy TC-Xe defines “worsen” as any of the following conditions:

- a. a 2% increase in traffic during the a.m. peak hour, p.m. peak hour or daily trips, or
- b. the addition of 100 or more daily trips, or
- c. the addition of 10 or more trips during the a.m. peak hour or the p.m. peak hour.

The County's current General Plan Policy TC-Xf notes that for all residential subdivisions of five or more parcels that worsens traffic on a County road as defined in Policies TC-Xe [A], [B] or [C] "the County shall condition the project to construct all road improvements necessary to maintain or attain Level of Service standards detailed in this Transportation and Circulation Element based on existing traffic plus traffic generated from the development plus forecasted traffic growth at 10-years from project submittal." For all other discretionary projects that worsen traffic "the County shall condition the project to construct all road improvements necessary to maintain or attain adopted LOS standards."

However, the El Dorado County Superior Court issued a ruling in July 2017 that found certain provisions in Measure E unconstitutional. The court ruled that the previous language contained in Measure Y was still valid as detailed below:

At the time of approval of a tentative map for a single family residential subdivision of five or more parcels that worsens (defined as a project that triggers Policy TC-Xe [A] or [B] or [C]) traffic on the County road system, the County shall do one of the following:

- (1) condition the project to construct all road improvements necessary to maintain or attain Level of Service standards detailed in this Transportation and Circulation Element based on existing traffic plus traffic generated from the development plus forecasted traffic growth at 10-years from project submittal; or
- (2) ensure the commencement of construction of the necessary road improvements are included in the County's 10-year CIP.

For all other discretionary projects that worsen (defined as a project that triggers Policy TC-Xe [A] or [B] or [C]) traffic on the County road system, the County shall do one of the following:

- (1) condition the project to construct all road improvements necessary to maintain or attain Level of Service standards as detailed in this Transportation and Circulation Element; or
- (2) ensure the construction of the necessary road improvements is included in the County's 20-year CIP.

Existing Traffic Volumes / Levels of Service

Traffic Volume Counts. New traffic counts were made for this study on June 12, 2019. Intersection turning movement counts were made at study intersections during the period from 4:00 p.m. to 6:00 p.m. The highest hourly traffic volume period within the two-hour window was identified as the peak hour and used for this analysis.

This analysis was limited to the weekday p.m. peak hour based on Caltrans and El Dorado County consideration of SR 49 traffic volumes throughout the day, as well as the relative difference between project's a.m. and p.m. peak hour trip generation. Available data indicates

that the background a.m. peak hour volume is less than that in the p.m. peak hour. As noted in the subsequent assessment of project trip generation, Dollar General Stores typically generate considerably less traffic during the morning peak period.

Figure 3 illustrates the intersection turning movement count data for these intersections. This figure also notes the geometric layout of each intersection and the location of traffic controls. This data has been used to determine the operating Level of Service (LOS) at each intersection.

Level of Service at Intersections. Levels of Service were calculated for different intersection control types using the respective methods presented in the Highway Capacity Manual, 6th Edition (HCM 6 Ed). Intersection Levels of Service were calculated using SYNCHRO 10.0 software. For intersections controlled by side street stop signs, the reported Level of Service reflects the “worst case” movement, which is typically those motorists waiting to enter the main street.

As indicated in Table 3, each intersection delivers a peak hour Level of Service that satisfies minimum El Dorado County standards. Peak hour traffic signal warrants are satisfied at the SR 49 / SR 193 intersection.

**TABLE 3
EXISTING INTERSECTION LEVELS OF SERVICE**

Intersection	Control	PM Peak Hour		Signal* Warranted
		Average Delay (veh/sec)	LOS	
1. State Route 49 / Saint Florian Court Northbound left turn Eastbound approach	EB Stop	8.7 13.7	A B	No
2. State Route 49 / Northside Drive Southbound left turn Westbound approach	WB Stop	7.9 16.3	A C	No
3. State Route 49 / Timberline Commercial Access Northbound left turn Eastbound approach	EB Stop	9.0 14.2	A B	No
4. State Route 49 / State Route 193	AWS	17.7	C	Yes
5. USPS Driveway / Northside Drive Southbound approach Eastbound approach	SB Stop	8.5 7.1	A A	No
* CA MUTCD Peak Hour Signal Warrant, Figure 4C-3. AWS is All-Way Stop Control				

95th Percentile Queues. Table 4 identifies the 95th percentile queues occurring during the p.m. peak hour at the SR 49 / SR 193 intersection. These values are a byproduct of HCM LOS analysis. As indicated, all estimated queues can be accommodated within the available storage, and no improvements are currently needed.

**TABLE 4
EXISTING INTERSECTION PEAK HOUR QUEUES**

Intersection	Lane	Storage (feet)	PM Peak Hour		Storage Adequate?
			Volume (vph)	95 th % Queue (feet)	
4. State Route 49 / SR 193	SB left	200 ¹	374	170	Yes
	NB left	150 ¹	15	<25	Yes
	WB approach	unlimited	200	40	Yes

¹lane continues as TWLT lane

Roadway Segment Level of Service. Table 5 identifies the current operating Level of Service on the roadways in the vicinity of the project. As shown, the roadway segments in this area operate at LOS D, with the exception of southbound SR 49 north of SR 193 which operates at LOS E.

**TABLE 5
EXISTING ROADWAY SEGMENT LEVELS OF SERVICE**

Road	Location	Direction	PM Peak Hour			Level of Service
			Volume (vph)	ATS (mph)	PTSF (%)	
SR 49	North of SR 193	Northbound	257	40.7	53.9	D
		Southbound	561	39.5	77.4	E
	South of SR 193	Northbound	213	42.1	58.3	D
		Southbound	256	41.8	65.8	D
SR 193	East of SR 49	Eastbound	467	40.3	72.3	D
		Westbound	200	41.6	47.0	D

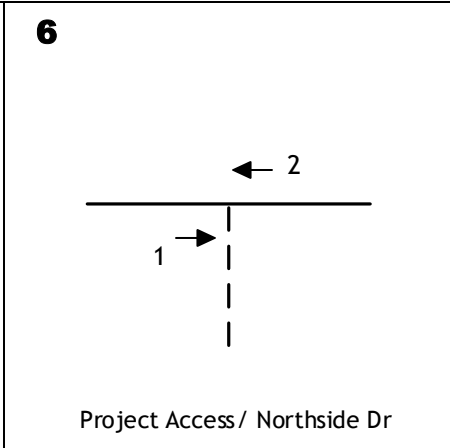
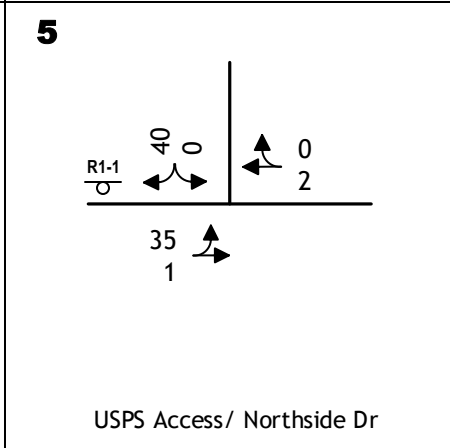
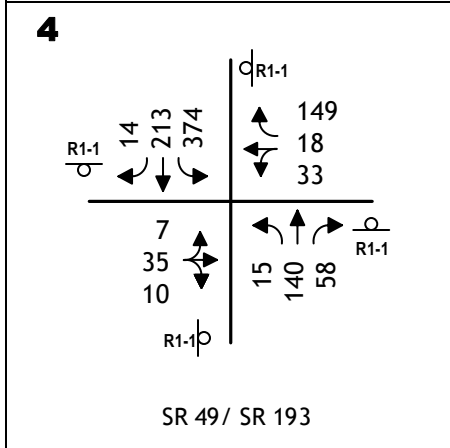
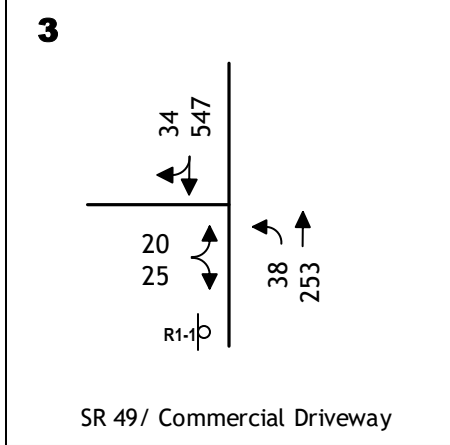
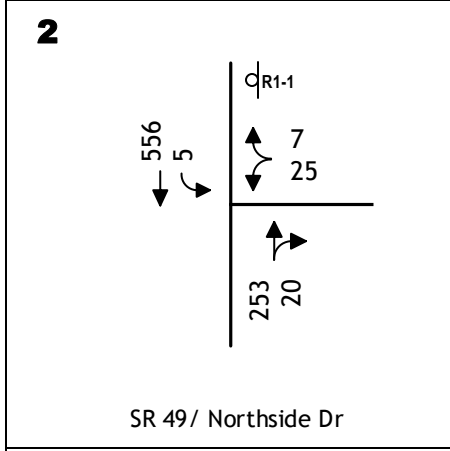
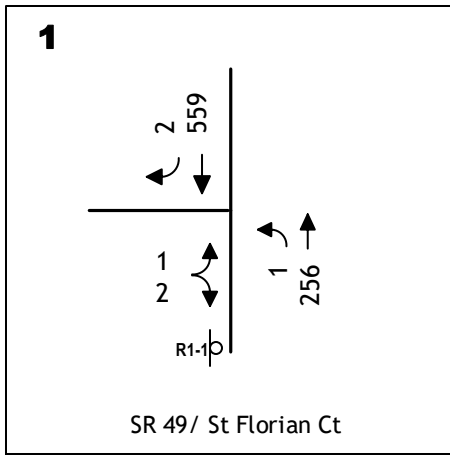

**EXISTING TRAFFIC VOLUMES AND
LANE CONFIGURATIONS**

Collision History

Traffic collision information was obtained for locations on SR 49 for the period of January 1, 2016 to December 31, 2018. During that time period a total of one collision was reported for the segment from 300 feet south of SR 193 to 300 feet north of St Florian Court. One rear-end collision occurred 65 feet south of SR 193. The statewide average collision rate for rural three-lane roads (i.e., with TWLT lane) is 0.94 per Million Vehicle Miles (MVM). Over three years this ¼ mile long segment experienced a rate of 0.42 per MVM.

Alternative Transportation Modes

Pedestrian Facilities. There are currently no sidewalks in the area surrounding the proposed project.

Bicycle Facilities. The *El Dorado County General Plan (2018)* outlines the location and nature of existing bicycle facilities in El Dorado County. Bicycle facilities are categorized within three classifications:

- Class I Bikeway: trails or paths that are separated from automobile traffic,
- Class II Bikeway: bicycle lanes that are on street but delineated by striping, and
- Class III Bikeway: bicycle routes where bicycles and automobiles share the road.

There are currently separated bicycle paths on the north side of SR 193 that extends for .83 miles from SR 49.

Transit Facilities. The El Dorado County Transit Authority (EDCTA) and Lake Tahoe Transit provide transit service in El Dorado County. The El Dorado County Transit Authority serves the residents of western El Dorado County, providing scheduled fixed-route service, daily commute service to Sacramento, dial-a-ride service in Placerville and outlying communities, and chartered social service routes. Life-line service is also provided to the elderly, the disabled, and Sacramento commuters. For EDCTA's fixed-route service, seven routes are local (within El Dorado County), and 12 are commuter routes to Sacramento County. In fiscal year 2000/2001, EDCTA served nearly 295,000 riders. The commuter service was particularly well used with an average weekday ridership of approximately 500. There are currently no bus routes that run through the surrounding area of the proposed project.

Regulatory Setting

El Dorado County General Plan. The El Dorado County General Plan Circulation Element sets forth future plans for the transportation system in the County.

State Route 49 TCR. Caltrans SR 49 (2017) identifies the long-range plan for this facility. SR 49 in this area will remain a 2-lane conventional highway with concept Level of Service D.

State Route 193 TCR. Caltrans SR 193 (2017) identifies the long-range plan for this facility. SR 193 in this area will remain a 2-lane conventional highway with concept Level of Service D.

PROJECT CHARACTERISTICS

The relative impacts of developing the Dollar General Store and the adequacy of site access is dependent on the physical characteristics of the adjoining street system, as well as the amount of traffic generated by the proposed project. The amount of additional traffic on a particular section of the street network is dependent upon two factors:

- I. Trip Generation, the number of new trips generated by the project, and
- II. Trip Distribution and Assignment, the specific routes that the new traffic takes.

Trip Generation

Trip Generation Rates. This analysis considered trip generation rates derived from several sources. The Institute of Transportation Engineers (ITE) publication “*Trip Generation, 10th Edition*” provides information on the characteristics of various retail uses. The use most similar to Dollar General Store is “Variety Store” (Code 814). The land use description notes that a Variety Store is a retail store providing health care & beauty aids, cleaning supplies, snack food, household items and some apparel. This is not a “dollar store” where everything is priced at one dollar, but rather is a small neighborhood store offering value and convenience. The stores studied were free-standing and catered to the local neighborhood. The 15 sites studied had building floor areas that ranged from roughly 8,000 to 17,000 square feet. Table 6 identifies the trip generation rates reported by ITE.

**TABLE 6
TRIP GENERATION RATES**

Land Use / Source	Unit	Daily	AM Peak Hour			PM Peak Hour		
			In	Out	Total	In	Out	Total
Variety Store (814)	ksf	63.47	57%	43%	3.18	52%	48%	6.82
Dollar General Store	9.1 ksf	578	16	13	29	32	30	62
Pass-by Trips	34%	<196>	<5>	<5>	<10>	<10>	<10>	<20>
Net New Trips		382	11	8	19	22	20	42

Source: ITE Trip Generation, 10th Edition

Trip Generation Forecasts. Table 6 also displays the p.m. peak hour trip generation forecasts for the 9.1 ksf Dollar General Store. The project would generate 62 p.m. peak hour trips at its driveway. A portion of the traffic drawn to these stores would be drawn from the stream of traffic already passing the site. The ITE *Trip Generation Handbook, 3rd Edition* notes that 34% of the weekday trips are “pass-by”.

As noted in Table 6, the project is expected to generate 42 “new” trips during the p.m. peak hour.

The volume of traffic generated by variety stores is highest at midday and during the evening commute period. On a daily basis, after discount for “pass-by trips”, the proposed project may generate 382 new daily trips (½ inbound and ½ outbound).

Truck Trips. The proposed project will receive regular deliveries from the Dollar General Stores regional distribution center serving this area of California. Project proponents anticipate that 1-2 full size trucks will visit the store each week, although smaller single unit trucks may visit each day. At typical Dollar General Stores some of the full-size trucks are expected to be STAA trucks (53') permitted on California highways under the Surface Transportation Authorization Act. However, when the regional routes providing access to individual stores are not designated for STAA, alternative vehicles are used. This is the case on this portion of SR 49 which is not an STAA terminal route.

The anticipated truck delivery route to and from this site will be to and from US 50 to the south, as noted in the illustration included in the appendix to this report.

Site truck circulation has been reviewed. The project will result in trucks turning into the site and turning first right into the parking aisle that runs parallel to Northside Drive. From that point the truck will back into the aisle towards the store's rear door. After completing the delivery, trucks will proceed to Northside Drive. This is a common Dollar General Store configuration, and the parking layout is wide enough to accommodate these movements.

Vehicle Trip Distribution / Assignment

The distribution of project traffic was determined based on knowledge of the demographic distribution of residences and competing stores in this area of El Dorado County and on market characteristics of Dollar General Stores. As noted in Table 7, assuming a primary trade area that extends 1-2 miles from the site, the new trips attracted to the site will arrive primarily from the south along SR 49 and east along SR 193, with lesser shares arriving from the north and from the businesses that already exist along SR 49. Pass-by trips will be drawn from passing traffic on SR 49 in general proportion to the current peak hour volumes from each direction.

**TABLE 7
DIRECTIONAL TRIP DISTRIBUTION (NEW TRIPS)**

Direction	Route	Percentage of New Trips
North	SR 49 north of Northside Drive	10%
East	SR 193 east of SR 49	40%
South	SR 49 south of Northside Drive	40%
West	Local businesses	10%
Total		100%

Using the trip generation and distribution assumptions described above, the trips generated by the proposed project were assigned to the study area street system. Figure 4 presents peak hour volumes accompanying development of the project.

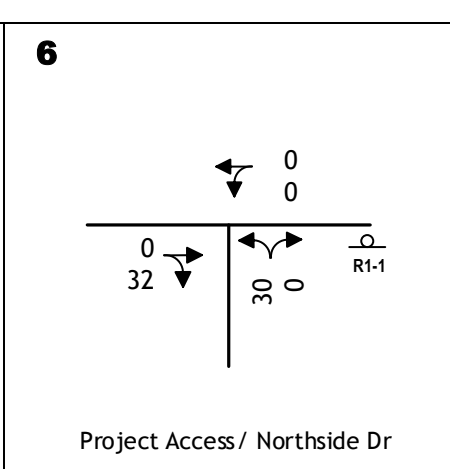
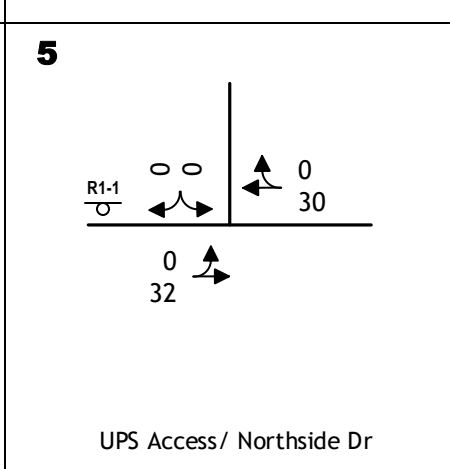
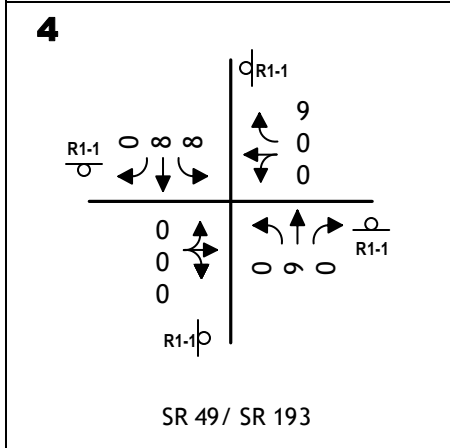
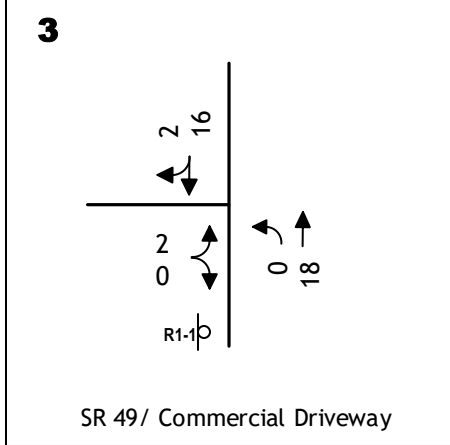
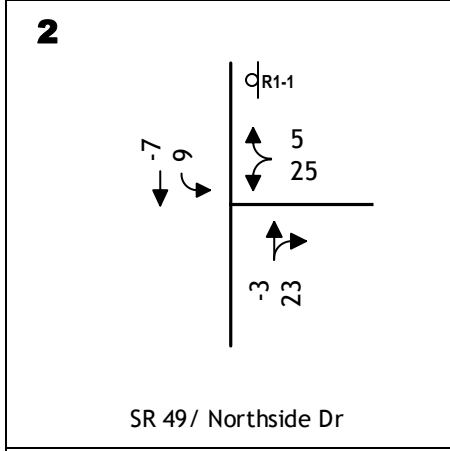
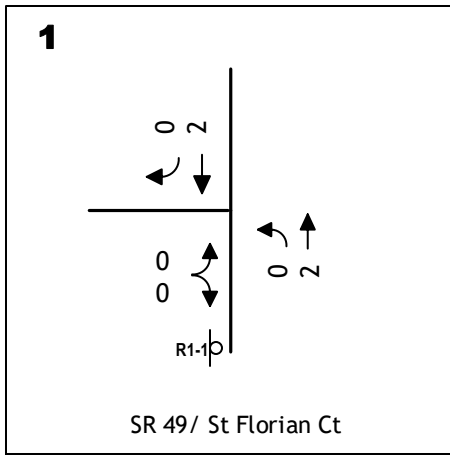

**PROJECT ONLY TRAFFIC VOLUMES
AND LANE CONFIGURATIONS**

PROJECT TRAFFIC IMPACTS

Existing Plus Project Traffic Conditions and Levels of Service

Figure 5 superimposes project trips onto the current background traffic volumes to create the “Existing plus Project” condition. Subsequent tables compare the “Existing” and “Existing plus Project” Levels of Service.

Project Traffic Impacts to Level of Service at Intersections. As shown in Table 8, because the amount of traffic projected to be generated by the project is relatively low, the addition of project traffic would not appreciably increase the length of delays already occurring at study intersections, and the project does not result in any change to the overall Level of Service at each location. Projected increases in delay are calculated to be less than one (1) second. Levels of Service will remain within adopted minimum standards of El Dorado County at each location.

Traffic Signal Warrants. The volume of traffic occurring at each intersection with development of the project was again compared to the CA MUTCD peak hour signal warrant thresholds. Traffic signals continue to be warranted at SR 49 / SR 193 with the project. The SR 193 TCR suggests a roundabout will someday be installed at this location, but no funding is identified. Currently, improvements to this intersection are not included in El Dorado County’s regional traffic impact fee program.

95th Percentile Queues. Table 9 identifies the 95th percentile queues occurring during the p.m. peak hour at the SR 49 / SR 193 intersection if the project is developed. As indicated, the queue in the southbound left turn lane may increase by about 10 feet as a result of the project. This queue will continue to be accommodated within the limits of the painted left turn lane. No improvements are needed.

Roadway Segments. As noted in Table 10, the project will add traffic to the state highway segments in this area. However, the volume of traffic is too small to have an appreciable effect on the performance of roadway segments. With the exception of SR 49 north of Cool, LOS D will remain in all areas. The project’s contribution to the segment of SR 49 that operates at LOS E is less than the increments used by El Dorado County to judge the significance of the identified traffic increase (i.e., less than 10 trips per hour).

**TABLE 8
EXISTING PLUS PROJECT INTERSECTION LEVELS OF SERVICE**

Intersection	Control	PM Peak Hour				Signal Warrant
		Existing No Project		Existing Plus Project		
		LOS	Average Delay (sec/veh)	LOS	Average Delay (sec/veh)	
1. State Route 49 / Saint Florian Court Northbound left turn Eastbound approach	EB Stop	A	8.7	A	8.7	No
		B	13.7	B	13.8	
2. State Route 49 / Northside Drive Southbound left turn Westbound approach	WB Stop	A	7.9	A	7.9	No
		C	16.3	C	18.5	
3. State Route 49 / Timberline Commercial Access Northbound left turn Eastbound approach	EB Stop	A	9.0	A	9.0	No
		B	14.2	B	14.6	
4. State Route 49 / State Route 193	AWS	C	17.7	C	18.8	Yes
5. USPS Driveway / Northside Drive Southbound approach Eastbound approach	SB Stop	A	8.5	A	8.7	No
		A	7.1	A	7.4	
6. Project Access / Northside Drive Northbound approach	NB Stop	--	--	A	8.7	No

KDA

**TABLE 9
EXISTING PLUS PROJECT INTERSECTION PEAK HOUR QUEUES**

Intersection	Lane	Storage (feet)	PM Peak Hour					
			No Project		Plus Project			
			Volume (vph)	95 th % Queue (feet)	Volume (vph)		95 th % Queue (feet)	Storage Adequate?
					Project Only	Total		
State Route 49 / SR 193	SB left	200 ¹	374	170	8	382	180	No
	NB left	150 ¹	25	<25	0	15	<25	Yes
	WB approach	unlimited	200	40	9	209	45	Yes

¹lane continues as TWLT lane

**TABLE 10
EXISTING PLUS PROJECT ROADWAY SEGMENT LEVELS OF SERVICE**

Road	Location	Direction	PM Peak Hour							
			Existing				Plus Project			
			Volume (vph)	ATS (mph)	PTSF (%)	LOS	Volume added (vph)	ATS (mph)	PTSF (%)	LOS
SR 49	North of SR 193 beyond Northside Dr	Northbound	257	40.7	53.9	D	2	40.7	53.9	D
		Southbound	561	39.5	77.4	E	2	39.5	77.5	E
	South of SR 193	Northbound	213	42.1	58.3	D	9	42.0	58.5	D
		Southbound	256	41.8	65.8	D	8	41.8	65.8	D
SR 193	East of SR 49	Eastbound	467	40.3	72.3	D	8	40.3	73.9	D
		Westbound	200	41.6	47.0	D	9	41.6	48.8	D

KDA

Project Impacts to Alternative Transportation Modes

Development of the proposed Dollar General Store may incrementally contribute to the demand for facilities to serve pedestrians, cyclists and transit riders in this area of El Dorado County, but this demand is expected to be relatively minor.

Pedestrian Impacts. It is unlikely employees or customers of this project will elect to walk in appreciable numbers to and from the site, as there is little residential or commercial development near the site.

Bicycle Impacts. While the use of bicycles may be an option for employees or customers to the site, such traffic will likely be low. The number of cyclists associated with this project is not likely to create any appreciable safety impacts on SR 49 where the paved shoulder is already available to provide access to the project.

Transit Impacts. Project employees or customers are unlikely to use bus transit service, as no fixed routes pass through the site area.

Site Access

Throat Depth. Access to the site is proposed via a driveway on the south side of Northside Drive. The driveway is 40 feet wide. The main parking aisle is separated from Northside Drive by about 40 feet of throat. Two waiting vehicles can queue prior to blocking access to those parking spaces. This layout is expected to operate satisfactorily given the low traffic volumes projected to be generated by the site. The Level of Service calculations indicate that the 95th percentile queue at the exit will be 1 vehicle or less during peak periods, which can be accommodated in the 40 feet.

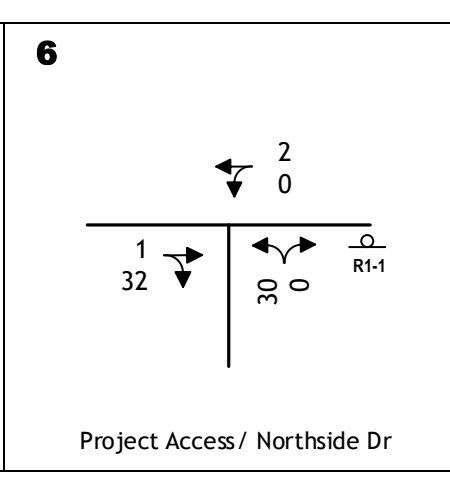
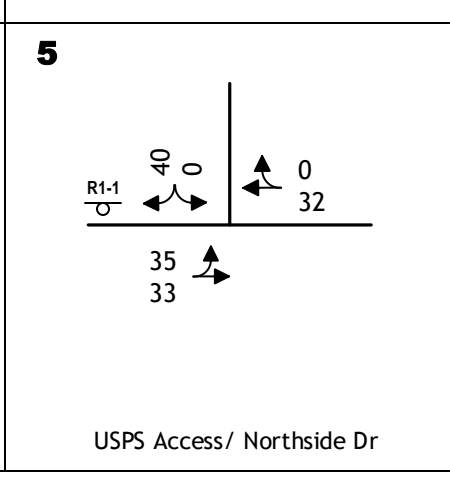
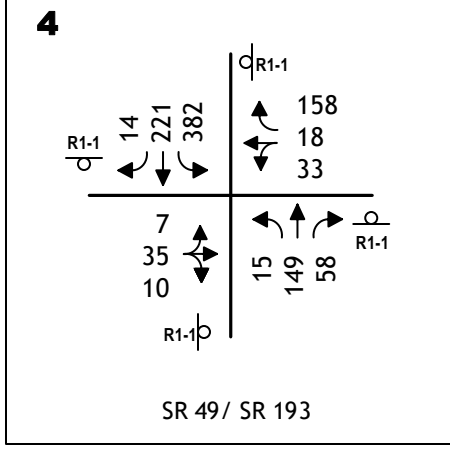
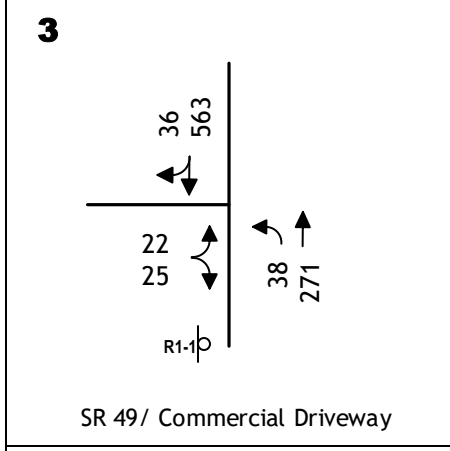
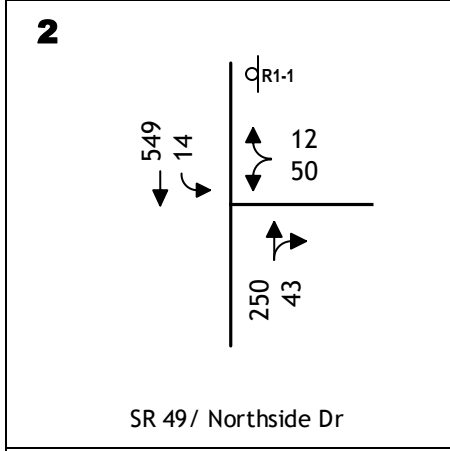
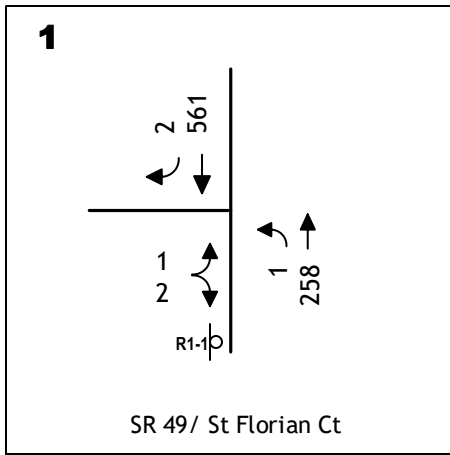

**EXISTING PLUS PROJECT TRAFFIC
VOLUMES AND LANE CONFIGURATIONS**

CUMULATIVE IMPACTS

The impacts of the Dollar General Store project have also been considered within the context of future traffic conditions in this area of El Dorado County. Long term traffic conditions have been forecast and evaluated based on forecasts from the El Dorado County regional demand forecasting model.

Year 2040 Long Term Cumulative Conditions

Approach to Developing Traffic Volume Forecasts. In El Dorado County long term future traffic conditions are identified by the regional travel demand forecasting model maintained by El Dorado County. This tool has been employed to develop traffic volume forecasts for the Regional Transportation Plan, and for EIR's prepared for projects throughout the County. The most current version of the model has been employed for this cumulative analysis.

Methods. The approach taken to prepare background traffic volume forecasts for this analysis makes use of data from the current version of the El Dorado County regional traffic model. The incremental change in peak hour traffic was determined on a segment by segment basis through comparison of Year 2015 baseline and Year 2040 forecasts (refer to Appendix for 2015 and 2040 model forecasts). These forecasts indicate that relatively little growth will occur on study area streets.

Traffic Volume Forecasts. Figure 6 identifies "No Project" background Year 2040 traffic volumes, while Figure 7 identifies Year 2040 volumes with Dollar General Store.

No Project Conditions. The following conditions are expected if the Dollar General project does not proceed.

Level of Service at Intersections / Traffic Signal Warrants. Peak hour intersection Levels of Service were recalculated assuming no change to current intersection geometries. As shown in Table 11, without the project all study intersections will continue to operate with Levels of Service that satisfy minimum LOS D standard. Peak hour traffic signal warrants (warrant 3) would be satisfied at the SR 49/SR 193 intersection.

95th Percentile Queues. Table 12 identifies the 95th percentile queues occurring at the SR 49 / SR 193 intersection under cumulative conditions if no improvements are made. As indicated, without the project the queue in the southbound SR 49 left turn lane may reach 300 feet. This distance exceeds the current left turn lane length, and the queue would extend about 100 feet into the adjoining TWLT lane. The back of the queue would be about 50 feet from the beginning of the driveway serving the property on the west side of SR 49. Caltrans may elect to modify the left turn lane striping in the future.

Roadway Segment Level of Service. As noted in Table 13, while background traffic volumes will increase in the future the Level of Service based on HCM techniques does not change. LOS E remains on SR 49 north of SR 193, and LOS D occurs elsewhere.

Plus Project Conditions. Adding trips from the Dollar General has the following effects.

Level of Service at Intersections / Traffic Signal Warrants. As noted in Table 11, the addition of project trips does not result in any intersection operating with Level of Service in excess of the LOS D minimum. Thus, the project's impacts are not significant, and mitigation is not required based on Level of Service.

95th Percentile Queues. The addition of project trips would increase this queue to 320 feet. This queue would be closer to but would not reach to the adjoining driveway.

Roadway Segment Levels of Service. The addition of project trips does not change the Level of Service on any roadway segment, and the project's contribution to SR 49 north of Cool remains less than significant based on County guidelines.

Mitigations. The proposed project would contribute its fair share to the cost of regional circulation improvements by paying adopted fees and making frontage improvements, but no additional mitigation related to roadway capacity and Level of Service is required.

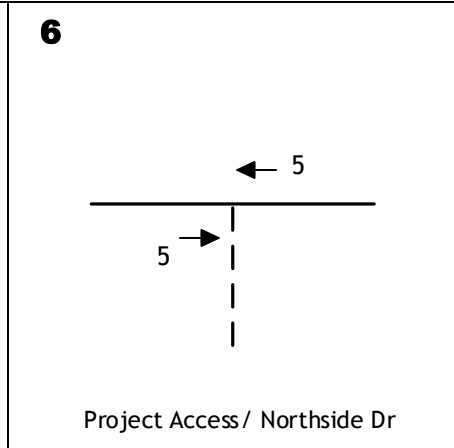
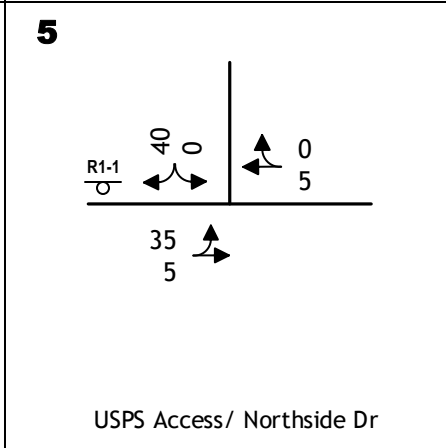
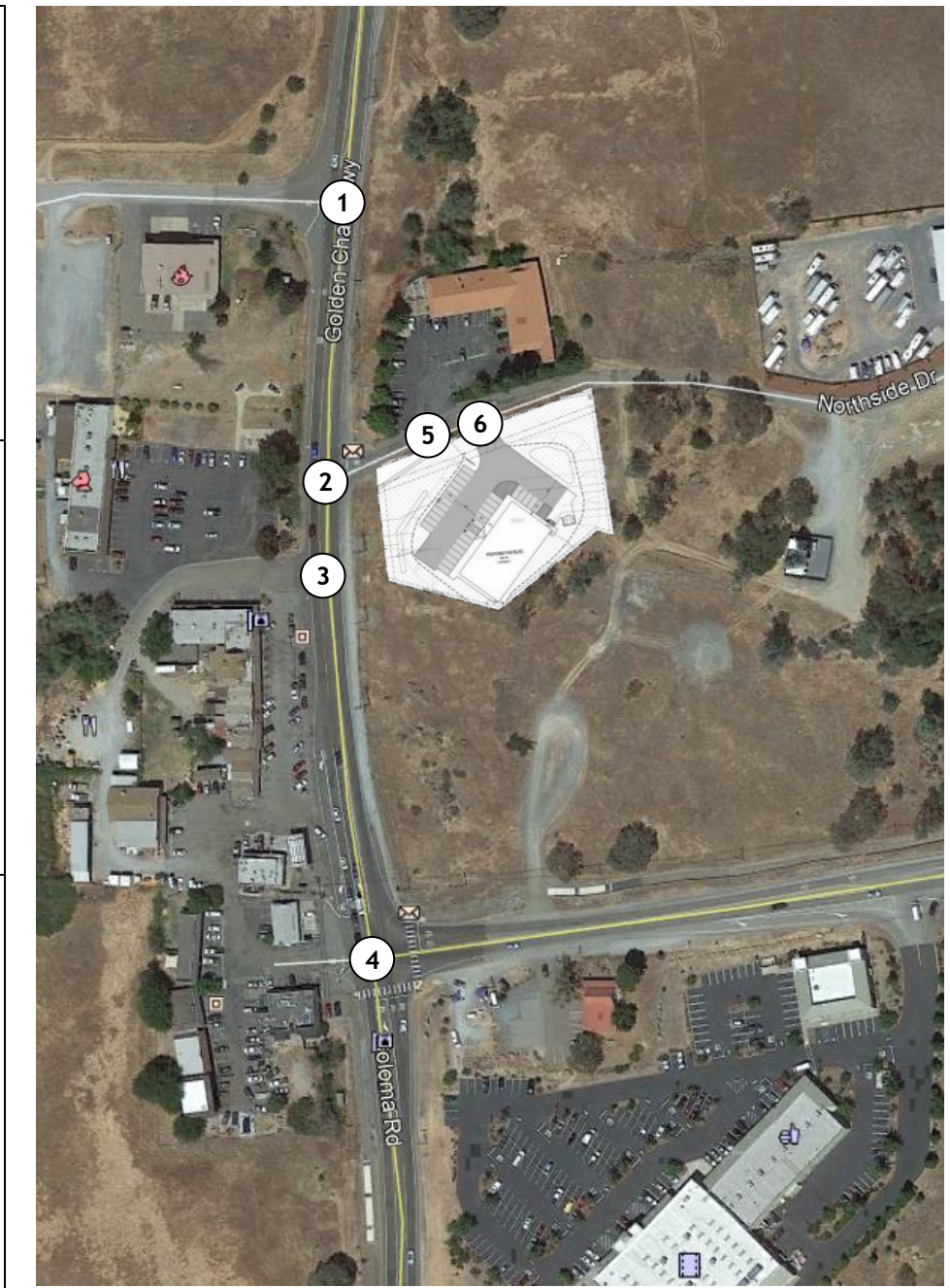
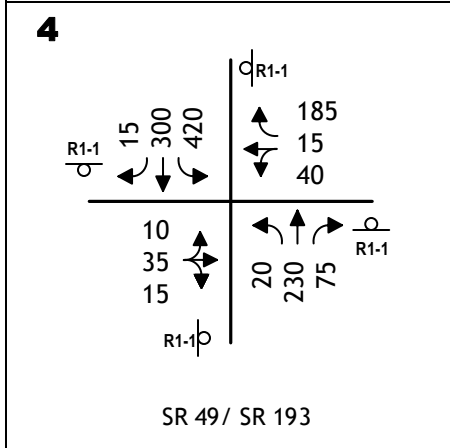
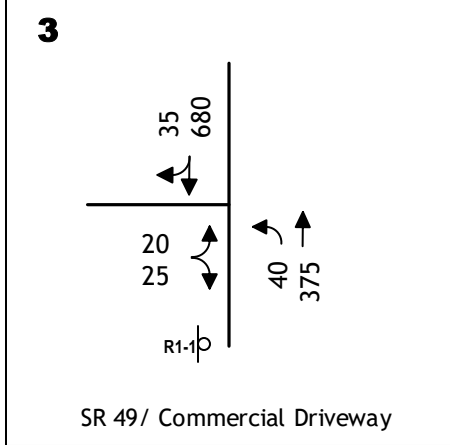
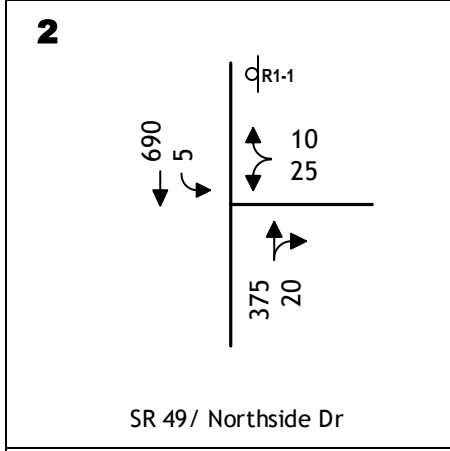
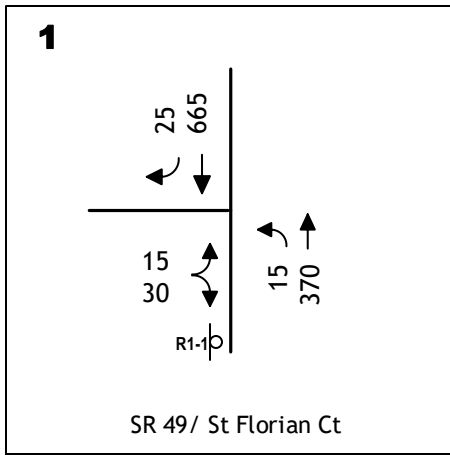

**CUMULATIVE TRAFFIC VOLUMES
AND LANE CONFIGURATIONS**

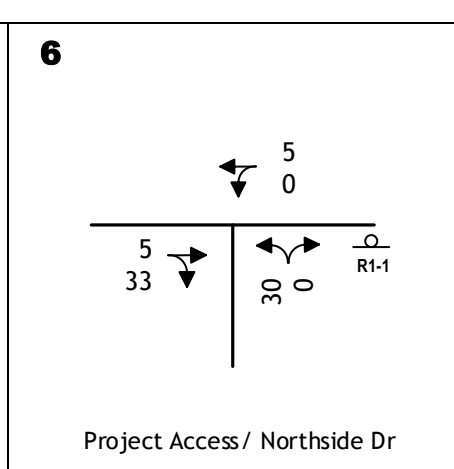
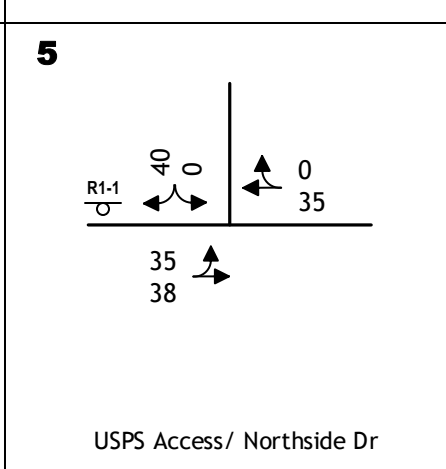
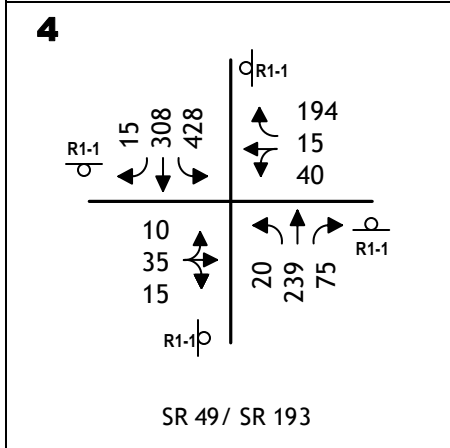
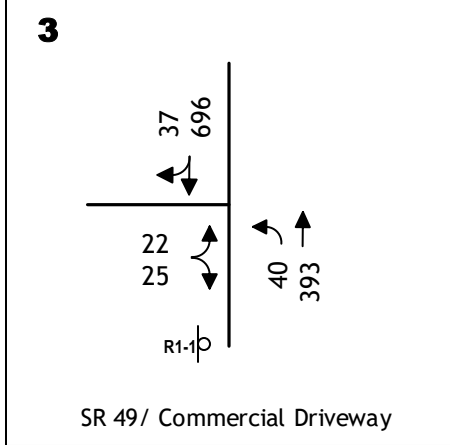
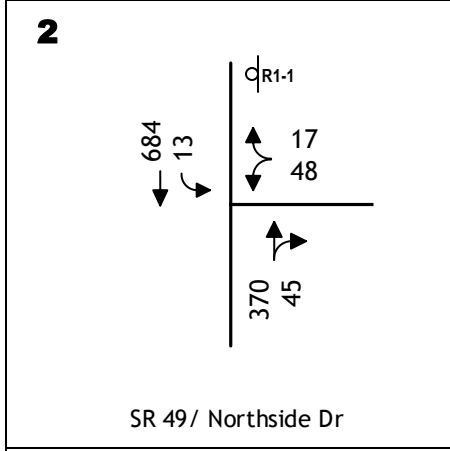
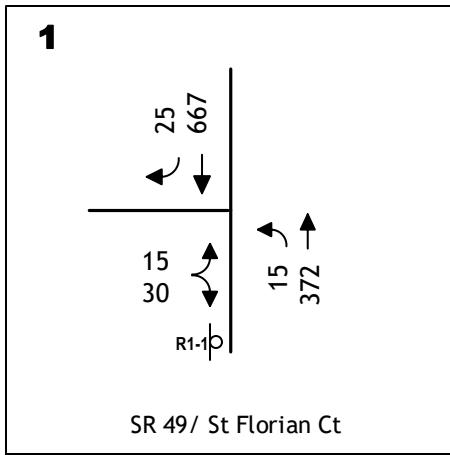

**CUMULATIVE PLUS PROJECT
TRAFFIC VOLUMES AND LANE CONFIGURATIONS**

**TABLE 11
YEAR 2040 PLUS PROJECT INTERSECTION LEVELS OF SERVICE**

Intersection	Control	PM Peak Hour				Signal Warrant
		Cumulative No Project		Cumulative Plus Project		
		LOS	Average Delay (sec/veh)	LOS	Average Delay (sec/veh)	
1. State Route 49 / Saint Florian Court Northbound left turn Eastbound approach	EB Stop	A C	9.3 18.3	A C	9.3 18.4	No
2. State Route 49 / Northside Drive Southbound left turn Westbound approach	WB Stop	A C	8.2 21.2	A D	8.3 25.4	No
3. State Route 49 / Timberline Commercial Access Northbound left turn Eastbound approach	EB Stop	A C	9.5 16.6	A C	9.6 17.2	No
4. State Route 49 / State Route 193	AWS	D	30.6	D	33.7	Yes
5. USPS Driveway / Northside Drive Southbound approach Eastbound approach	SB Stop	A A	8.5 7.3	A A	8.7 7.4	No
6. Project Access / Northside Drive Northbound approach	NB Stop	--	--	A	8.8	No

**TABLE 12
YEAR 2040 PLUS PROJECT INTERSECTION PEAK HOUR QUEUES**

Intersection	Lane	Storage (feet)	PM Peak Hour					
			No Project			Plus Project		
			Volume (vph)	95 th % Queue (feet)	Volume (vph)		95 th % Queue (feet)	Storage Adequate?
					Project Only	Total		
State Route 49 / SR 193	SB left	200 ¹	420	300	8	428	320	No
	NB left	150 ¹	20	<25	0	20	<25	Yes
	WB approach	unlimited	240	65	9	249	70	Yes

¹lane continues as TWLT lane

**TABLE 13
YEAR 2040 PLUS PROJECT ROADWAY SEGMENT LEVELS OF SERVICE**

Road	Location	Direction	PM Peak Hour							
			No Project				Plus Project			
			Volume (vph)	ATS (mph)	PTSF (%)	LOS	Volume added (vph)	ATS (mph)	PTSF (%)	LOS
SR 49	North of SR 193 beyond Northside Dr	Northbound	425	38.6	65.9	E	2	38.6	66.1	E
		Southbound	735	37.7	84.4	E	2	37.7	84.4	E
	South of SR 193	Northbound	325	41.3	64.2	D	9	41.3	65.5	D
		Southbound	330	41.3	65.3	D	8	41.2	66.5	D
SR 193	East of SR 49	Eastbound	530	40.1	73.1	D	8	40.1	76.2	D
		Westbound	240	41.0	51.7	D	9	40.9	52.9	D

KDA

SUMMARY AND CONCLUSIONS

This report documents **KD Anderson & Associates'** analysis of the traffic impacts associated with developing a Dollar General Store on Northside Drive in El Dorado County, California. The analysis addresses both current and future background conditions at key intersections in the vicinity of the site. To assess traffic impacts, the characteristics of the proposed project have been determined, including estimated trip generation and the directional distribution / assignment of project generated traffic.

The proposed project consists of a 9.1 ksf Dollar General Store located on a 1.68 acre site on the south side of Northside Drive about 190 feet east of SR 49. The project will include development of 31 parking spaces per El Dorado County Zoning Ordinance requirements. Access to the site will be provided via a new driveway to Northside Drive. The Northside Drive site frontage is currently unimproved, with no frontage improvements beyond the driveway improvements are planned with the development of the project.

Trip Generation. The project is expected to generate a total of 578 daily trips, with roughly 11% or 62 trips during the p.m. peak hour. After discounting for pass-by trips already occurring on SR 49 adjacent to the site, the project is projected to generate 42 new trips in the weekday p.m. peak hours.

Existing Plus Project Traffic Conditions. Development of the project alone does not result in a significant impact to traffic based on the criteria adopted by El Dorado County. Satisfactory operations are currently experienced at the study intersections and no changes to existing Levels of Service are projected with development of the site. Traffic signal warrants are met with and without the project at the SR 49/ SR 193 intersection. Current peak period queues can be accommodated within existing turn lanes. The current roadway segment Levels of Service on state highways near the project which range from LOS D on SR 193 and SR 49 south of Cool to LOS E on SR 49 north of Cool will not change as a result of the project, and the increment of traffic added to SR 49 north of Cool falls below the County's significance criteria (i.e., <10 vph).

The project access will be improved to El Dorado County encroachment permit standards.

Long Term Cumulative (Year 2040) Traffic Impacts. The study intersections are projected to operate without significant delays in the future with the existing traffic controls, and the County's LOS D minimum standard for intersections will be met with or without development of the proposed project. The project does not change the roadway segment LOS projected on state highways, and while SR 49 north of Cool will continue to operate at LOS E with and without the project, the increment of traffic added by the Dollar Generals falls below the County's significance criteria. Traffic signal warrants would continue to be met at the SR 49/SR 193 intersection. With and without the project the queue of peak period traffic in the southbound left turn lane at the SR 49 / SR 193 intersection will extend beyond the striped turn pocket. The queue will extend into the adjoining TWLT lane but will not reach the next driveway on the west side of SR 49.

Typically, El Dorado County monitors the operation of intersections, and adds improvements such as traffic signals to the fee priority list as appropriate. The proposed project would contribute its fair share to the cost of regional circulation improvements, including any SR 49/SR193 improvements by paying adopted fees, and no additional mitigation related to roadway capacity and Level of Service is required.

APPENDIX

(Traffic Counts, LOS Calculations)

Prepared by National Data & Surveying Services

SR 49 & St Florian Ct

Peak Hour Turning Movement Count

ID: 19-07230-001
City: Cool

Day: Wednesday
Date: 06/12/2019

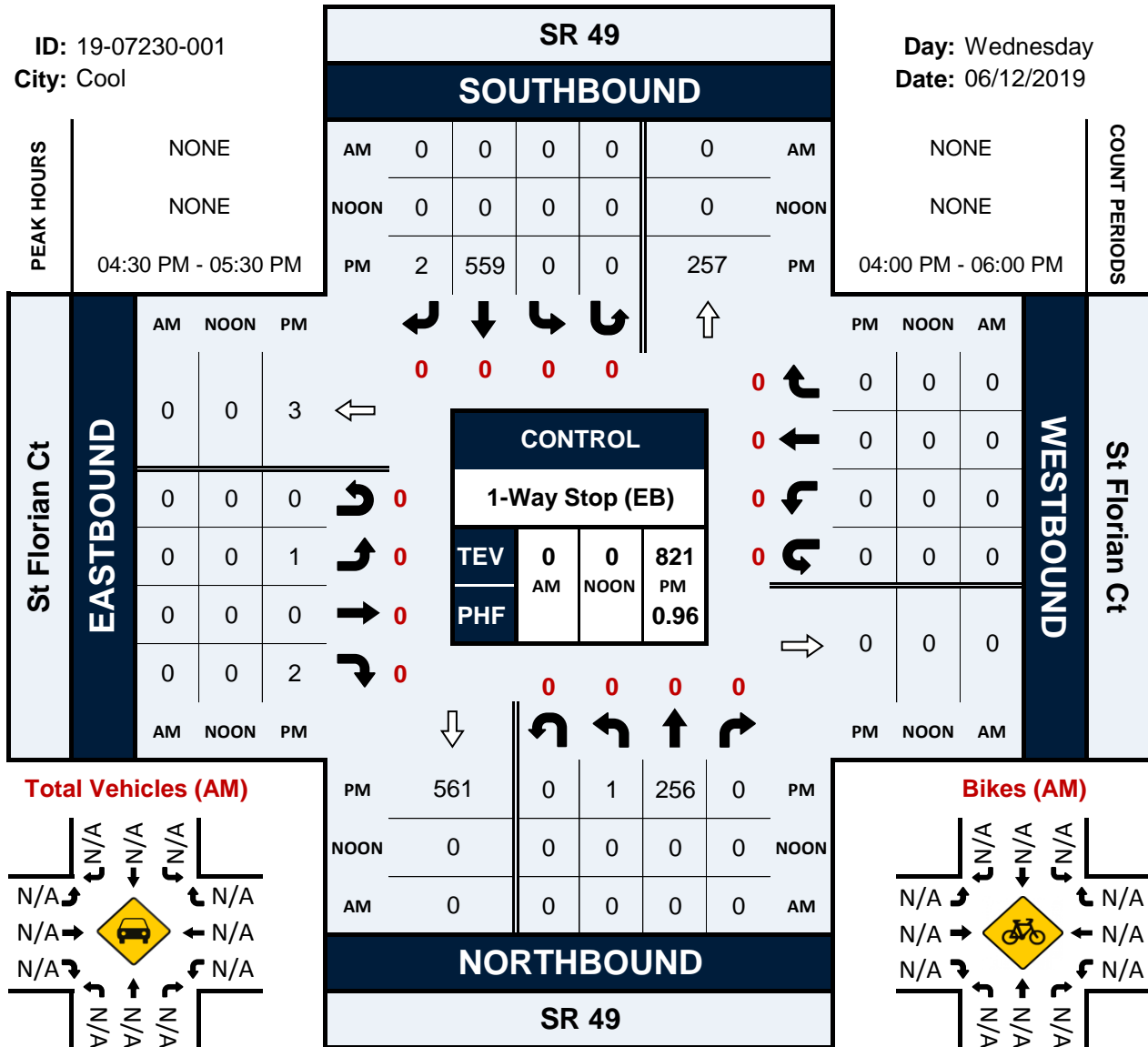

Total Vehicles (AM)

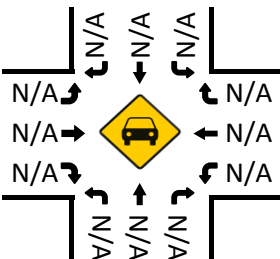

Bikes (AM)

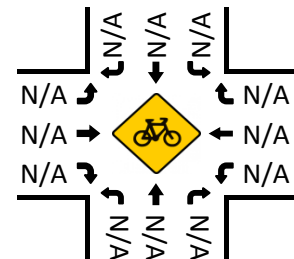

Total Vehicles (Noon)

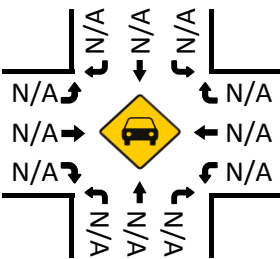

Bikes (NOON)

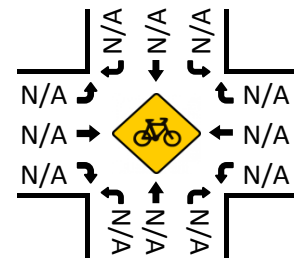

Total Vehicles (PM)

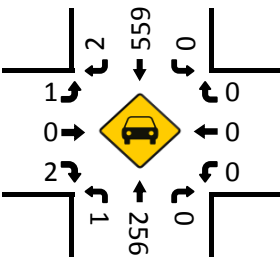

Bikes (PM)

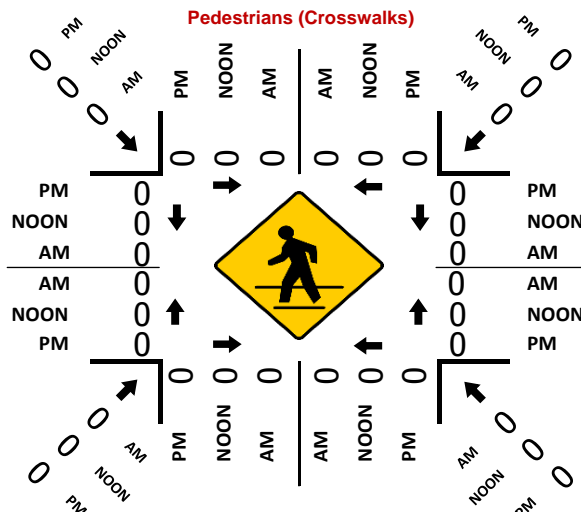
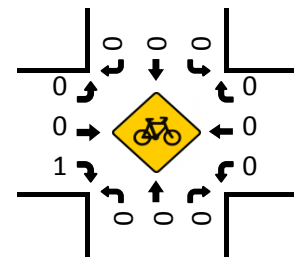

National Data & Surveying Services

Intersection Turning Movement Count

Location: SR 49 & St Florian Ct
 City: Cool
 Control: 1-Way Stop (EB)

Project ID: 19-07230-001
 Date: 6/12/2019

Total

NS/EW Streets:	SR 49				SR 49				St Florian Ct				St Florian Ct				TOTAL
	NORTHBOUND				SOUTHBOUND				EASTBOUND				WESTBOUND				
PM	0	0	0	0	0	0	0	0	0	0	0	0	0	0	0	0	TOTAL
	NL	NT	NR	NU	SL	ST	SR	SU	EL	ET	ER	EU	WL	WT	WR	WU	
4:00 PM	0	45	0	0	0	106	0	0	0	0	1	0	0	0	0	0	152
4:15 PM	0	71	0	0	0	101	1	0	0	0	0	0	0	0	0	0	173
4:30 PM	0	69	0	0	0	144	0	0	0	0	1	0	0	0	0	0	214
4:45 PM	1	59	0	0	0	128	0	0	0	0	0	0	0	0	0	0	188
5:00 PM	0	65	0	0	0	139	1	0	1	0	1	0	0	0	0	0	207
5:15 PM	0	63	0	0	0	148	1	0	0	0	0	0	0	0	0	0	212
5:30 PM	0	50	0	0	0	128	0	0	0	0	0	0	0	0	0	0	178
5:45 PM	0	54	0	0	0	124	1	0	0	0	1	0	0	0	0	0	180
TOTAL VOLUMES :	NL	NT	NR	NU	SL	ST	SR	SU	EL	ET	ER	EU	WL	WT	WR	WU	TOTAL
	1	476	0	0	0	1018	4	0	1	0	4	0	0	0	0	0	1504
APPROACH %'s :	0.21%	99.79%	0.00%	0.00%	0.00%	99.61%	0.39%	0.00%	20.00%	0.00%	80.00%	0.00%					
PEAK HR :	04:30 PM - 05:30 PM																TOTAL
PEAK HR VOL :	1	256	0	0	0	559	2	0	1	0	2	0	0	0	0	0	821
PEAK HR FACTOR :	0.250	0.928	0.000	0.000	0.000	0.944	0.500	0.000	0.250	0.000	0.500	0.000	0.000	0.000	0.000	0.000	0.959
		0.931				0.941				0.375							

National Data & Surveying Services

Intersection Turning Movement Count

Location: SR 49 & St Florian Ct
 City: Cool
 Control: 1-Way Stop (EB)

Project ID: 19-07230-001
 Date: 6/12/2019

Bikes

NS/EW Streets:	SR 49				SR 49				St Florian Ct				St Florian Ct				
PM	NORTHBOUND				SOUTHBOUND				EASTBOUND				WESTBOUND				TOTAL
	0	0	0	0	0	0	0	0	0	0	0	0	0	0	0	0	
	NL	NT	NR	NU	SL	ST	SR	SU	EL	ET	ER	EU	WL	WT	WR	WU	
4:00 PM	1	0	0	0	0	0	0	0	0	0	0	0	0	0	0	0	1
4:15 PM	0	0	0	0	0	0	0	0	0	0	0	0	0	0	0	0	0
4:30 PM	0	0	0	0	0	0	0	0	0	0	0	0	0	0	0	0	0
4:45 PM	0	0	0	0	0	0	0	0	0	0	0	0	0	0	0	0	0
5:00 PM	0	0	0	0	0	0	0	0	0	0	0	0	0	0	0	0	0
5:15 PM	0	0	0	0	0	0	0	0	0	0	1	0	0	0	0	0	1
5:30 PM	0	0	0	0	0	0	0	0	0	0	0	0	0	0	0	0	0
5:45 PM	0	0	0	0	0	0	0	0	0	0	0	0	0	0	0	0	0
TOTAL VOLUMES :	1	0	0	0	0	0	0	0	0	0	1	0	0	0	0	0	2
APPROACH %'s :	100.00%	0.00%	0.00%	0.00%					0.00%	0.00%	100.00%	0.00%					
PEAK HR :	04:30 PM - 05:30 PM																
PEAK HR VOL :	0	0	0	0	0	0	0	0	0	0	1	0	0	0	0	0	1
PEAK HR FACTOR :	0.00	0.000	0.000	0.000	0.000	0.000	0.000	0.000	0.000	0.000	0.250	0.000	0.000	0.000	0.000	0.000	0.250

National Data & Surveying Services

Intersection Turning Movement Count

Location: SR 49 & St Florian Ct
City: Cool

Project ID: 19-07230-001
Date: 6/12/2019

Pedestrians (Crosswalks)

NS/EW Streets:	SR 49		SR 49		St Florian Ct		St Florian Ct		
PM	NORTH LEG		SOUTH LEG		EAST LEG		WEST LEG		
	EB	WB	EB	WB	NB	SB	NB	SB	TOTAL
4:00 PM	0	0	0	0	0	0	0	0	0
4:15 PM	0	0	0	0	0	0	0	0	0
4:30 PM	0	0	0	0	0	0	0	0	0
4:45 PM	0	0	0	0	0	0	0	0	0
5:00 PM	0	0	0	0	0	0	0	0	0
5:15 PM	0	0	0	0	0	0	0	0	0
5:30 PM	0	0	0	0	0	0	0	0	0
5:45 PM	0	0	0	0	0	0	0	0	0
TOTAL VOLUMES :	EB	WB	EB	WB	NB	SB	NB	SB	TOTAL
APPROACH %'s :	0	0	0	0	0	0	0	0	0
PEAK HR :	04:30 PM - 05:30 PM								TOTAL
PEAK HR VOL :	0	0	0	0	0	0	0	0	0
PEAK HR FACTOR :									

Prepared by National Data & Surveying Services

SR 49 & Northside Dr

Peak Hour Turning Movement Count

ID: 19-07230-002
City: Cool

Day: Wednesday
Date: 06/12/2019

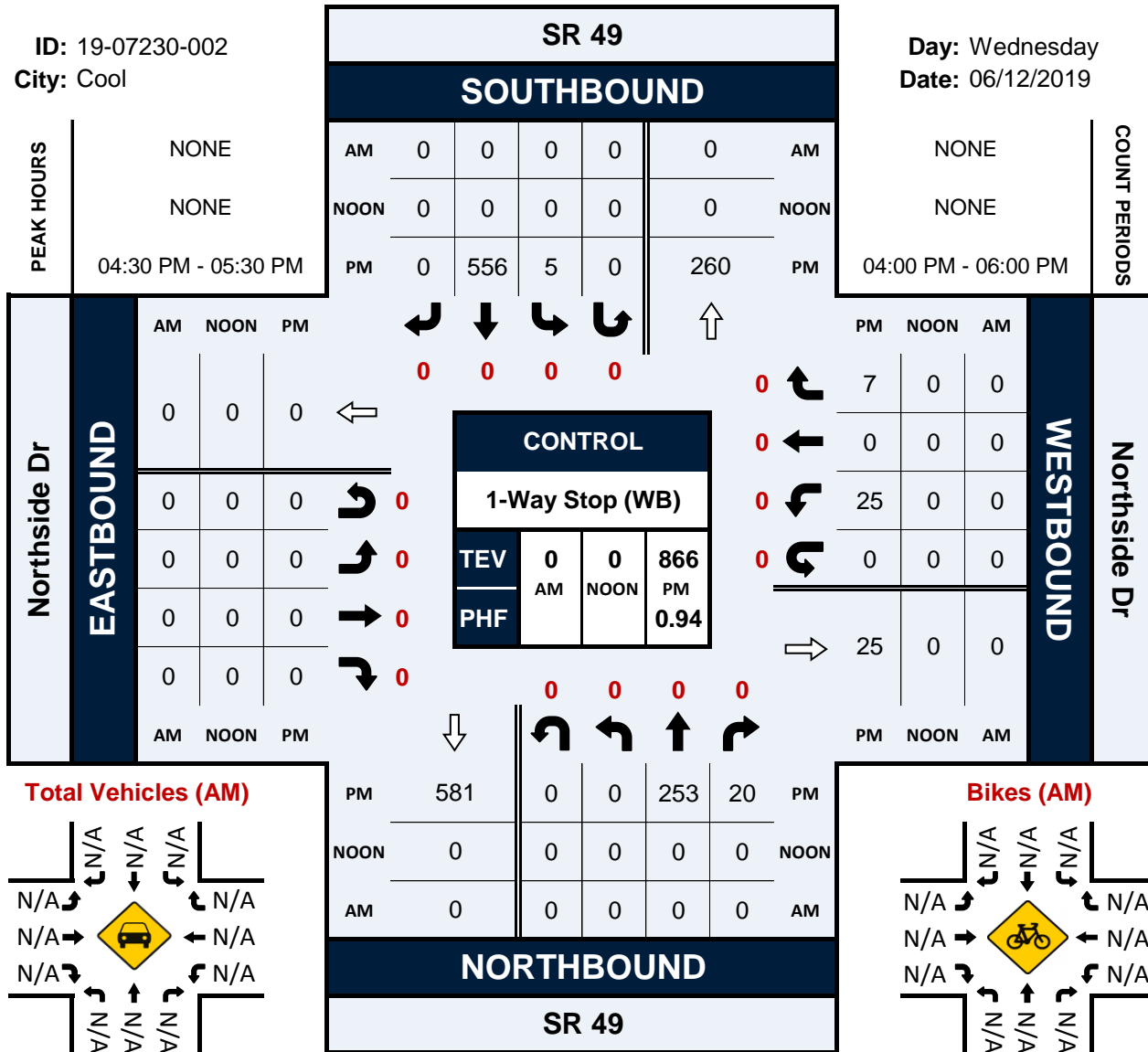

Total Vehicles (AM)

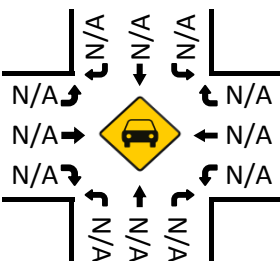

Bikes (AM)

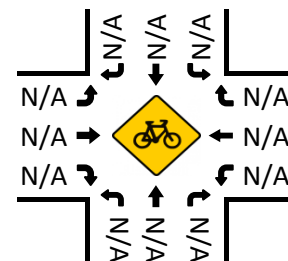

Total Vehicles (Noon)

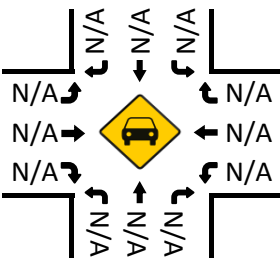

Bikes (NOON)

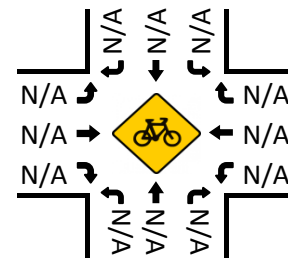

Total Vehicles (PM)

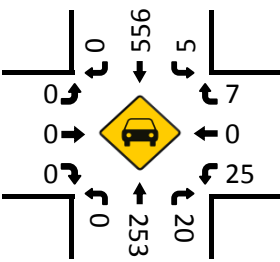

Bikes (PM)

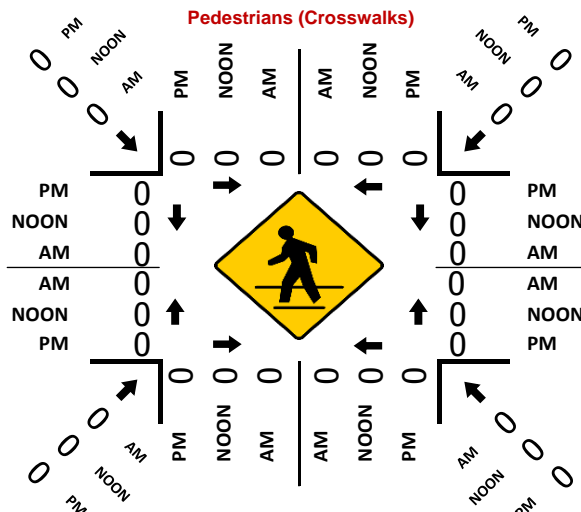
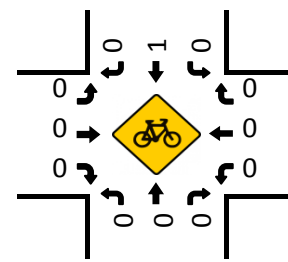

National Data & Surveying Services

Intersection Turning Movement Count

Location: SR 49 & Northside Dr
 City: Cool
 Control: 1-Way Stop (WB)

Project ID: 19-07230-002
 Date: 6/12/2019

Total

NS/EW Streets:	SR 49				SR 49				Northside Dr				Northside Dr				TOTAL				
	NORTHBOUND				SOUTHBOUND				EASTBOUND				WESTBOUND								
PM	0	0	0	0	0	0	0	0	0	0	0	0	0	0	0	0	0	0	0	0	
	NL	NT	NR	NU	SL	ST	SR	SU	EL	ET	ER	EU	WL	WT	WR	WU					
4:00 PM	0	43	6	0	2	105	0	0	0	0	0	0	6	0	3	0					165
4:15 PM	0	66	10	0	3	99	0	0	0	0	0	0	10	0	2	0					190
4:30 PM	0	70	6	0	1	143	0	0	0	0	0	0	10	0	1	0					231
4:45 PM	0	57	6	0	2	125	0	0	0	0	0	0	8	0	2	0					200
5:00 PM	0	65	5	0	2	139	0	0	0	0	0	0	3	0	1	0					215
5:15 PM	0	61	3	0	0	149	0	0	0	0	0	0	4	0	3	0					220
5:30 PM	0	47	6	0	1	126	0	0	0	0	0	0	6	0	1	0					187
5:45 PM	0	55	1	0	0	125	0	0	0	0	0	0	2	0	0	0					183
TOTAL VOLUMES :	0	464	43	0	11	1011	0	0	0	0	0	0	49	0	13	0					1591
APPROACH %'s :	0.00%	91.52%	8.48%	0.00%	1.08%	98.92%	0.00%	0.00%					79.03%	0.00%	20.97%	0.00%					
PEAK HR :	04:30 PM - 05:30 PM																				TOTAL
PEAK HR VOL :	0	253	20	0	5	556	0	0	0	0	0	0	25	0	7	0					866
PEAK HR FACTOR :	0.000	0.904	0.833	0.000	0.625	0.933	0.000	0.000	0.000	0.000	0.000	0.000	0.625	0.000	0.583	0.000					0.937
			0.898			0.941								0.727							

National Data & Surveying Services

Intersection Turning Movement Count

Location: SR 49 & Northside Dr
City: Cool
Control: 1-Way Stop (WB)

Project ID: 19-07230-002
Date: 6/12/2019

Bikes

NS/EW Streets:	SR 49				SR 49				Northside Dr				Northside Dr				
PM	NORTHBOUND				SOUTHBOUND				EASTBOUND				WESTBOUND				TOTAL
	NL	NT	NR	NU	SL	ST	SR	SU	EL	ET	ER	EU	WL	WT	WR	WU	
4:00 PM	0	1	0	0	0	0	0	0	0	0	0	0	0	0	0	0	1
4:15 PM	0	0	0	0	0	0	0	0	0	0	0	0	0	0	0	0	0
4:30 PM	0	0	0	0	0	0	0	0	0	0	0	0	0	0	0	0	0
4:45 PM	0	0	0	0	0	0	0	0	0	0	0	0	0	0	0	0	0
5:00 PM	0	0	0	0	0	0	0	0	0	0	0	0	0	0	0	0	0
5:15 PM	0	0	0	0	0	1	0	0	0	0	0	0	0	0	0	0	1
5:30 PM	0	0	0	0	0	0	0	0	0	0	0	0	0	0	0	0	0
5:45 PM	0	0	0	0	0	0	0	0	0	0	0	0	0	0	0	0	0
TOTAL VOLUMES :	NL	NT	NR	NU	SL	ST	SR	SU	EL	ET	ER	EU	WL	WT	WR	WU	TOTAL
APPROACH %'s :	0	1	0	0	0	1	0	0	0	0	0	0	0	0	0	0	2
	0.00%	100.00%	0.00%	0.00%	0.00%	100.00%	0.00%	0.00%									
PEAK HR :	04:30 PM - 05:30 PM																TOTAL
PEAK HR VOL :	0	0	0	0	0	1	0	0	0	0	0	0	0	0	0	0	1
PEAK HR FACTOR :	0.00	0.000	0.000	0.000	0.000	0.250	0.000	0.000	0.000	0.000	0.000	0.000	0.000	0.000	0.000	0.000	0.250

National Data & Surveying Services

Intersection Turning Movement Count

Location: SR 49 & Northside Dr
City: Cool

Project ID: 19-07230-002
Date: 6/12/2019

Pedestrians (Crosswalks)

NS/EW Streets:	SR 49		SR 49		Northside Dr		Northside Dr		
PM	NORTH LEG		SOUTH LEG		EAST LEG		WEST LEG		TOTAL
	EB	WB	EB	WB	NB	SB	NB	SB	
4:00 PM	0	0	0	0	0	0	0	0	0
4:15 PM	0	0	0	0	0	0	0	0	0
4:30 PM	0	0	0	0	0	0	0	0	0
4:45 PM	0	0	0	0	0	0	0	0	0
5:00 PM	0	0	0	0	0	0	0	0	0
5:15 PM	0	0	0	0	0	0	0	0	0
5:30 PM	0	0	0	0	0	0	0	0	0
5:45 PM	0	0	0	0	0	0	0	0	0
TOTAL VOLUMES :	EB	WB	EB	WB	NB	SB	NB	SB	TOTAL
APPROACH %'s :	0	0	0	0	0	0	0	0	0
PEAK HR :	04:30 PM - 05:30 PM								TOTAL
PEAK HR VOL :	0	0	0	0	0	0	0	0	0
PEAK HR FACTOR :									

Prepared by National Data & Surveying Services

United States Postal Service Dwy Access & Northside Dr

Peak Hour Turning Movement Count

ID: 19-07230-003
City: Cool

Day: Wednesday
Date: 06/12/2019

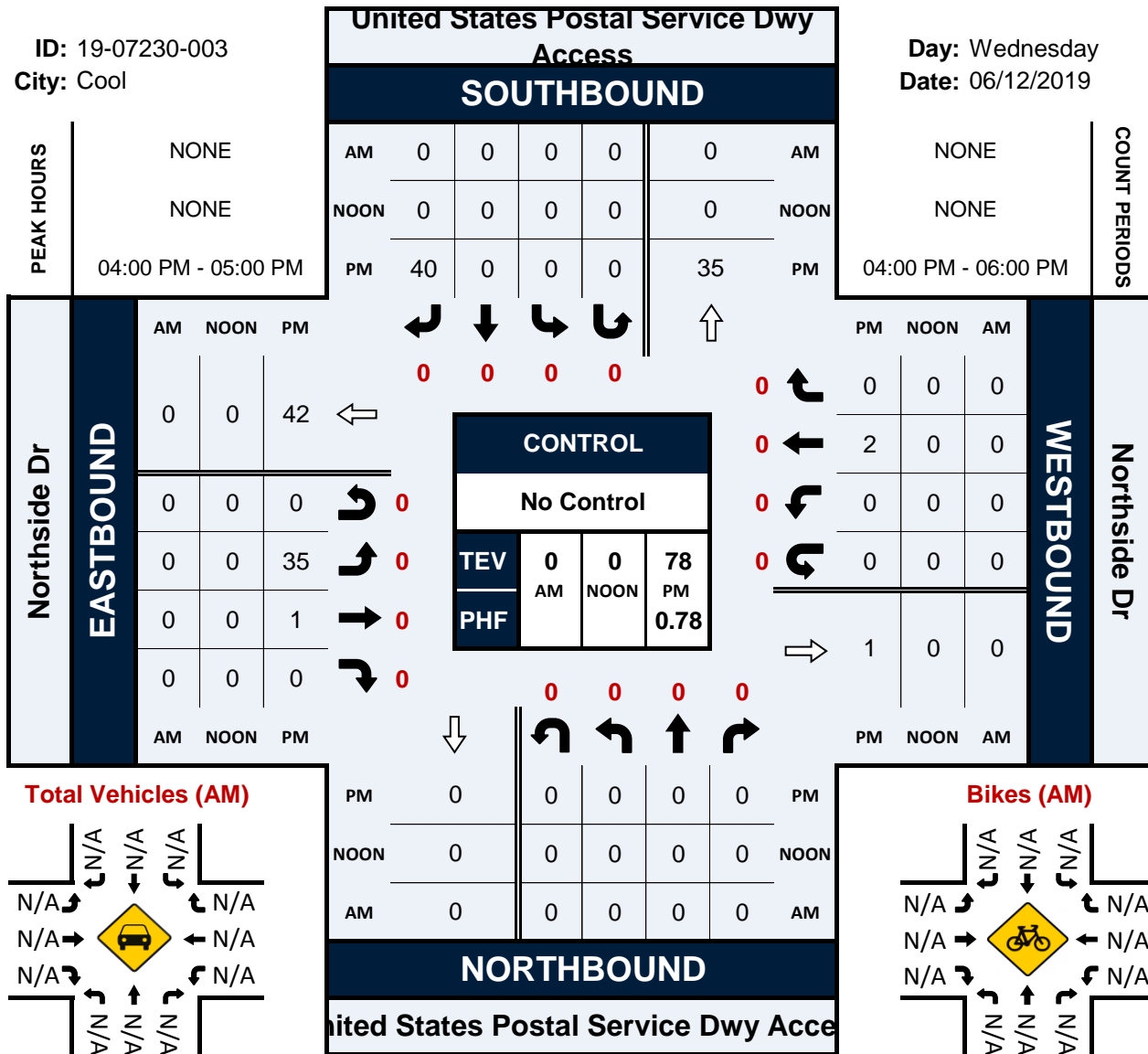

Total Vehicles (AM)

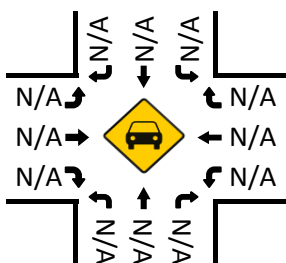

Total Vehicles (Noon)

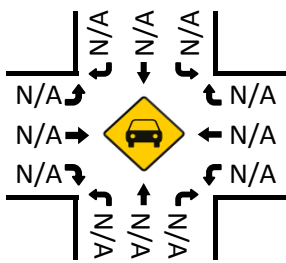

Total Vehicles (PM)

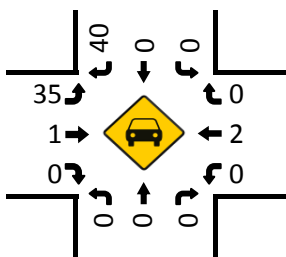

Bikes (AM)

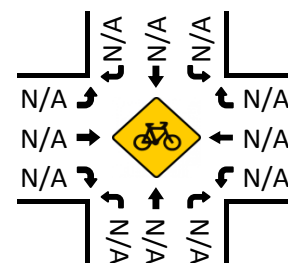

Bikes (Noon)

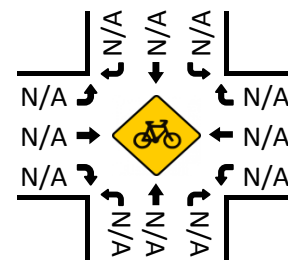

Bikes (PM)

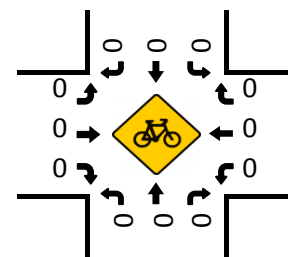

Pedestrians (Crosswalks)

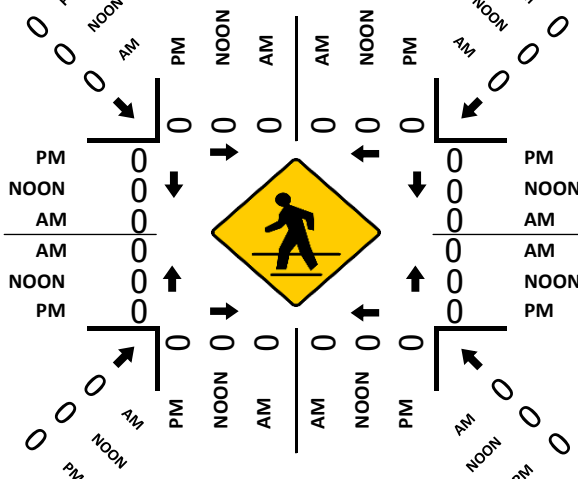

National Data & Surveying Services

Intersection Turning Movement Count

Location: United States Postal Service Dwy Access & Northside Dr
City: Cool
Control: No Control

Project ID: 19-07230-003
Date: 6/12/2019

Total

NS/EW Streets:	United States Postal Service Dwy Access				United States Postal Service Dwy Access				Northside Dr				Northside Dr				TOTAL				
	NORTHBOUND				SOUTHBOUND				EASTBOUND				WESTBOUND								
PM	0	0	0	0	0	0	0	0	0	0	0	0	0	0	0	0	0	0	0	0	TOTAL
	NL	NT	NR	NU	SL	ST	SR	SU	EL	ET	ER	EU	WL	WT	WR	WU					
4:00 PM	0	0	0	0	0	0	9	0	8	0	0	0	0	0	0	0					17
4:15 PM	0	0	0	0	0	0	10	0	12	1	0	0	0	2	0	0					25
4:30 PM	0	0	0	0	0	0	12	0	7	0	0	0	0	0	0	0					19
4:45 PM	0	0	0	0	0	0	9	0	8	0	0	0	0	0	0	0					17
5:00 PM	0	0	0	0	0	0	4	0	5	2	0	0	0	0	0	0					11
5:15 PM	0	0	0	0	0	0	5	0	3	0	0	0	0	2	0	0					10
5:30 PM	0	0	0	0	0	0	7	0	7	0	0	0	0	0	0	0					14
5:45 PM	0	0	0	0	0	0	2	0	1	0	0	0	0	0	0	0					3
TOTAL VOLUMES :	0	0	0	0	0	0	58	0	51	3	0	0	0	4	0	0					116
APPROACH %'s :					0.00%	0.00%	100.00%	0.00%	94.44%	5.56%	0.00%	0.00%	0.00%	100.00%	0.00%	0.00%					
PEAK HR :	04:00 PM - 05:00 PM																				TOTAL
PEAK HR VOL :	0	0	0	0	0	0	40	0	35	1	0	0	0	2	0	0					78
PEAK HR FACTOR :	0.000	0.000	0.000	0.000	0.000	0.000	0.833	0.000	0.729	0.250	0.000	0.000	0.000	0.250	0.000	0.000					0.780
							0.833				0.692				0.250						

National Data & Surveying Services

Intersection Turning Movement Count

Location: United States Postal Service Dwy Access & Northside Dr
City: Cool
Control: No Control

Project ID: 19-07230-003
Date: 6/12/2019

Bikes

NS/EW Streets:	United States Postal Service Dwy Access				United States Postal Service Dwy Access				Northside Dr				Northside Dr				
PM	NORTHBOUND				SOUTHBOUND				EASTBOUND				WESTBOUND				TOTAL
	0 NL	0 NT	0 NR	0 NU	0 SL	0 ST	0 SR	0 SU	0 EL	0 ET	0 ER	0 EU	0 WL	0 WT	0 WR	0 WU	
4:00 PM	0	0	0	0	0	0	0	0	0	0	0	0	0	0	0	0	0
4:15 PM	0	0	0	0	0	0	0	0	0	0	0	0	0	0	0	0	0
4:30 PM	0	0	0	0	0	0	0	0	0	0	0	0	0	0	0	0	0
4:45 PM	0	0	0	0	0	0	0	0	0	0	0	0	0	0	0	0	0
5:00 PM	0	0	0	0	0	0	0	0	0	0	0	0	0	0	0	0	0
5:15 PM	0	0	0	0	0	0	0	0	0	0	0	0	0	0	0	0	0
5:30 PM	0	0	0	0	0	0	0	0	0	0	0	0	0	0	0	0	0
5:45 PM	0	0	0	0	0	0	0	0	0	0	0	0	0	0	0	0	0
TOTAL VOLUMES :	0	0	0	0	0	0	0	0	0	0	0	0	0	0	0	0	TOTAL 0
APPROACH %'s :																	
PEAK HR :	04:00 PM - 05:00 PM																TOTAL
PEAK HR VOL :	0	0	0	0	0	0	0	0	0	0	0	0	0	0	0	0	0
PEAK HR FACTOR :	0.00	0.000	0.000	0.000	0.000	0.000	0.000	0.000	0.000	0.000	0.000	0.000	0.000	0.000	0.000	0.000	TOTAL 0

National Data & Surveying Services

Intersection Turning Movement Count

Location: United States Postal Service Dwy Access & Northside Dr
 City: Cool

Project ID: 19-07230-003
 Date: 6/12/2019

Pedestrians (Crosswalks)

NS/EW Streets:	United States Postal Service Dwy Access		United States Postal Service Dwy Access		Northside Dr		Northside Dr		
PM	NORTH LEG		SOUTH LEG		EAST LEG		WEST LEG		TOTAL
	EB	WB	EB	WB	NB	SB	NB	SB	
4:00 PM	0	0	0	0	0	0	0	0	0
4:15 PM	0	0	0	0	0	0	0	0	0
4:30 PM	0	0	0	0	0	0	0	0	0
4:45 PM	0	0	0	0	0	0	0	0	0
5:00 PM	0	0	0	0	0	0	0	0	0
5:15 PM	0	0	0	0	0	0	0	0	0
5:30 PM	0	0	0	0	0	0	0	0	0
5:45 PM	0	0	0	0	0	0	0	0	0
TOTAL VOLUMES :	EB	WB	EB	WB	NB	SB	NB	SB	TOTAL
APPROACH %'s :	0	0	0	0	0	0	0	0	0
PEAK HR :	04:00 PM - 05:00 PM								TOTAL
PEAK HR VOL :	0	0	0	0	0	0	0	0	0
PEAK HR FACTOR :									

Prepared by National Data & Surveying Services

SR 49 & Kirkson Realty / Timberline Commercial Dwy

Peak Hour Turning Movement Count

ID: 19-07230-004
City: Cool

Day: Wednesday
Date: 06/12/2019

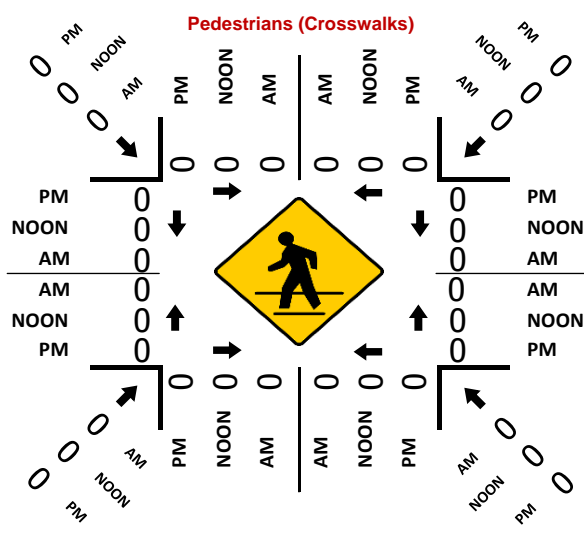
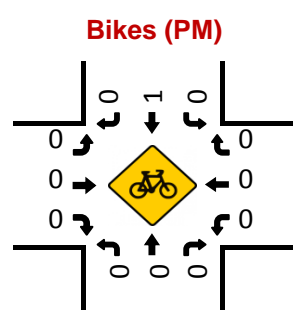
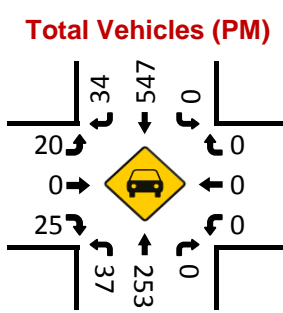
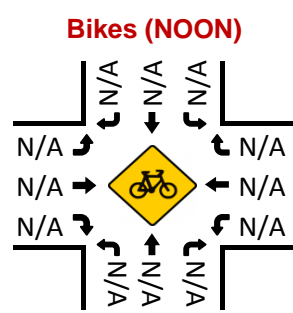
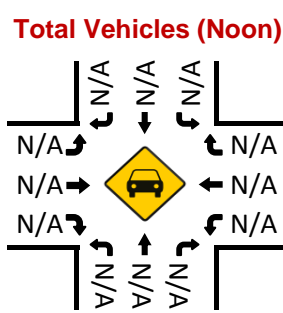
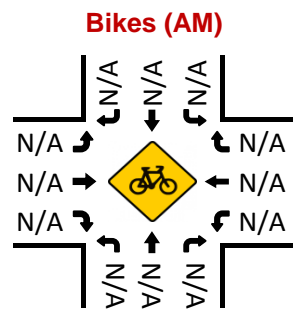
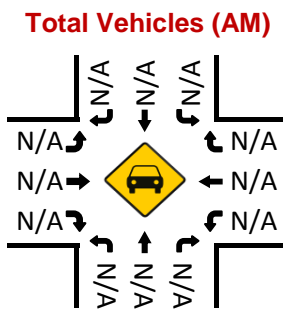
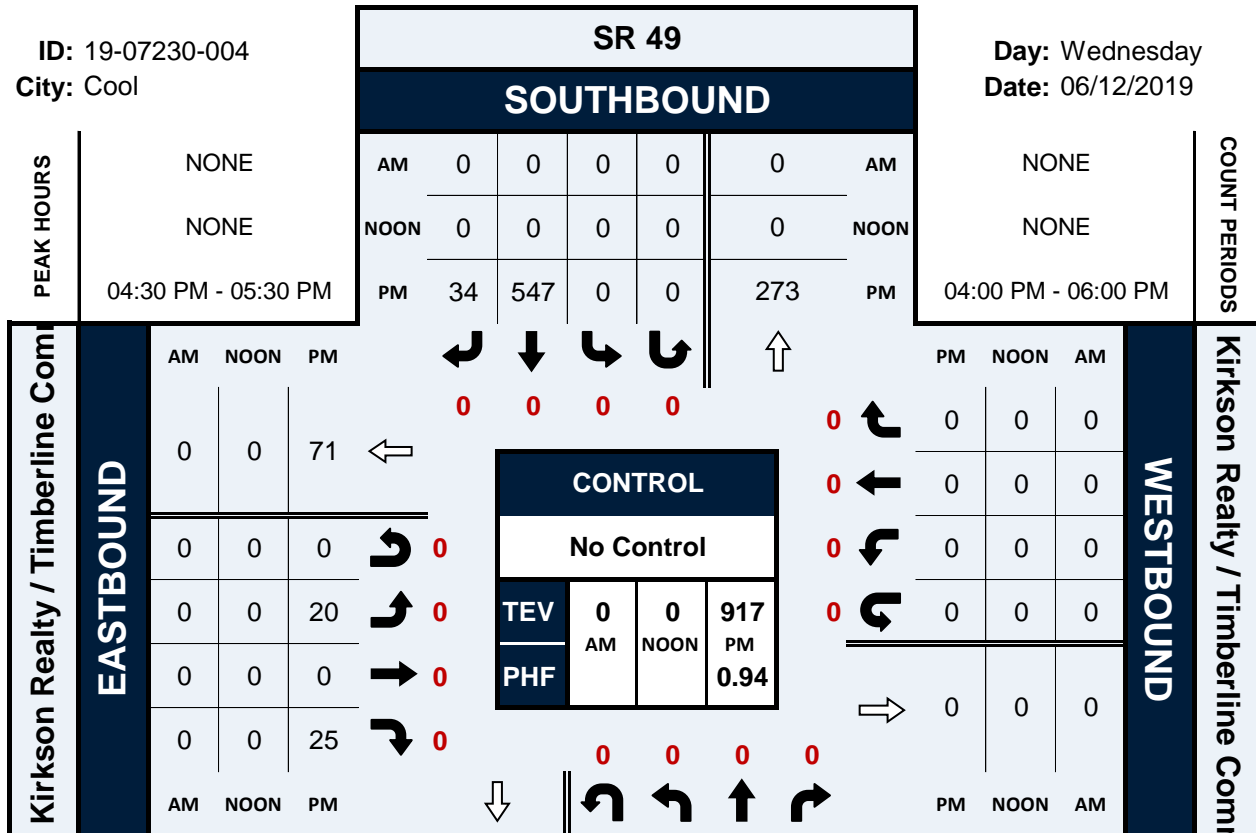

National Data & Surveying Services

Intersection Turning Movement Count

Location: SR 49 & Kirkson Realty / Timberline Commercial Dwy
 City: Cool
 Control: No Control

Project ID: 19-07230-004
 Date: 6/12/2019

Total

NS/EW Streets:	SR 49				SR 49				Kirkson Realty / Timberline Commercial Dwy				Kirkson Realty / Timberline Commercial Dwy				TOTAL				
	NORTHBOUND				SOUTHBOUND				EASTBOUND				WESTBOUND								
PM	0	0	0	0	0	0	0	0	0	0	0	0	0	0	0	0	0	0	0	0	
	NL	NT	NR	NU	SL	ST	SR	SU	EL	ET	ER	EU	WL	WT	WR	WU					
4:00 PM	9	46	0	0	0	103	9	0	4	0	6	0	0	0	0	0					177
4:15 PM	2	73	0	0	0	103	5	0	2	0	4	0	0	0	0	0					189
4:30 PM	5	71	0	0	0	143	9	0	5	0	6	0	0	0	0	0					239
4:45 PM	5	61	0	0	0	125	9	0	4	0	0	0	0	0	0	0					204
5:00 PM	13	60	0	0	0	133	9	0	8	0	8	0	0	0	0	0					231
5:15 PM	14	61	0	1	0	146	7	0	3	0	11	0	0	0	0	0					243
5:30 PM	9	48	0	0	0	129	2	0	4	0	5	0	0	0	0	0					197
5:45 PM	8	55	0	1	0	122	6	0	2	0	5	0	0	0	0	0					199
TOTAL VOLUMES :	NL	NT	NR	NU	SL	ST	SR	SU	EL	ET	ER	EU	WL	WT	WR	WU					TOTAL
	65	475	0	2	0	1004	56	0	32	0	45	0	0	0	0	0					1679
APPROACH %'s :	11.99%	87.64%	0.00%	0.37%	0.00%	94.72%	5.28%	0.00%	41.56%	0.00%	58.44%	0.00%									
PEAK HR :	04:30 PM - 05:30 PM																				TOTAL
PEAK HR VOL :	37	253	0	1	0	547	34	0	20	0	25	0	0	0	0	0					917
PEAK HR FACTOR :	0.661	0.891	0.000	0.250	0.000	0.937	0.944	0.000	0.625	0.000	0.568	0.000	0.000	0.000	0.000	0.000					0.943
			0.957				0.949				0.703										

National Data & Surveying Services

Intersection Turning Movement Count

Location: SR 49 & Kirkson Realty / Timberline Commercial Dwy
City: Cool
Control: No Control

Project ID: 19-07230-004
Date: 6/12/2019

Bikes

NS/EW Streets:	SR 49				SR 49				Kirkson Realty / Timberline Commercial Dwy				Kirkson Realty / Timberline Commercial Dwy				
PM	NORTHBOUND				SOUTHBOUND				EASTBOUND				WESTBOUND				TOTAL
	NL	NT	NR	NU	SL	ST	SR	SU	EL	ET	ER	EU	WL	WT	WR	WU	
4:00 PM	0	1	0	0	0	0	0	0	0	0	0	0	0	0	0	0	1
4:15 PM	0	0	0	0	0	0	0	0	0	0	0	0	0	0	0	0	0
4:30 PM	0	0	0	0	0	0	0	0	0	0	0	0	0	0	0	0	0
4:45 PM	0	0	0	0	0	0	0	0	0	0	0	0	0	0	0	0	0
5:00 PM	0	0	0	0	0	0	0	0	0	0	0	0	0	0	0	0	0
5:15 PM	0	0	0	0	0	1	0	0	0	0	0	0	0	0	0	0	1
5:30 PM	0	0	0	0	0	0	0	0	0	0	0	0	0	0	0	0	0
5:45 PM	0	0	0	0	0	0	0	0	0	0	0	0	0	0	0	0	0
TOTAL VOLUMES :	NL	NT	NR	NU	SL	ST	SR	SU	EL	ET	ER	EU	WL	WT	WR	WU	TOTAL
APPROACH %'s :	0	1	0	0	0	1	0	0	0	0	0	0	0	0	0	0	2
	0.00%	100.00%	0.00%	0.00%	0.00%	100.00%	0.00%	0.00%									
PEAK HR :	04:30 PM - 05:30 PM																TOTAL
PEAK HR VOL :	0	0	0	0	0	1	0	0	0	0	0	0	0	0	0	0	1
PEAK HR FACTOR :	0.00	0.000	0.000	0.000	0.000	0.250	0.000	0.000	0.000	0.000	0.000	0.000	0.000	0.000	0.000	0.000	0.250

National Data & Surveying Services

Intersection Turning Movement Count

Location: SR 49 & Kirkson Realty / Timberline Commercial Dwy
City: Cool

Project ID: 19-07230-004
Date: 6/12/2019

Pedestrians (Crosswalks)

NS/EW Streets:	SR 49		SR 49		Kirkson Realty / Timberline Commercial		Kirkson Realty / Timberline Commercial		
PM	NORTH LEG		SOUTH LEG		EAST LEG		WEST LEG		TOTAL
	EB	WB	EB	WB	NB	SB	NB	SB	
4:00 PM	0	0	0	0	0	0	0	0	0
4:15 PM	0	0	0	0	0	0	0	0	0
4:30 PM	0	0	0	0	0	0	0	0	0
4:45 PM	0	0	0	0	0	0	0	0	0
5:00 PM	0	0	0	0	0	0	0	0	0
5:15 PM	0	0	0	0	0	0	0	0	0
5:30 PM	0	0	0	0	0	0	0	0	0
5:45 PM	0	0	0	0	0	0	0	0	0
TOTAL VOLUMES :	EB	WB	EB	WB	NB	SB	NB	SB	TOTAL
APPROACH %'s :	0	0	0	0	0	0	0	0	0
PEAK HR :	04:30 PM - 05:30 PM								TOTAL
PEAK HR VOL :	0	0	0	0	0	0	0	0	0
PEAK HR FACTOR :									

Prepared by National Data & Surveying Services

SR 49 & SR 193

Peak Hour Turning Movement Count

ID: 19-07230-005
City: Cool

Day: Wednesday
Date: 06/12/2019

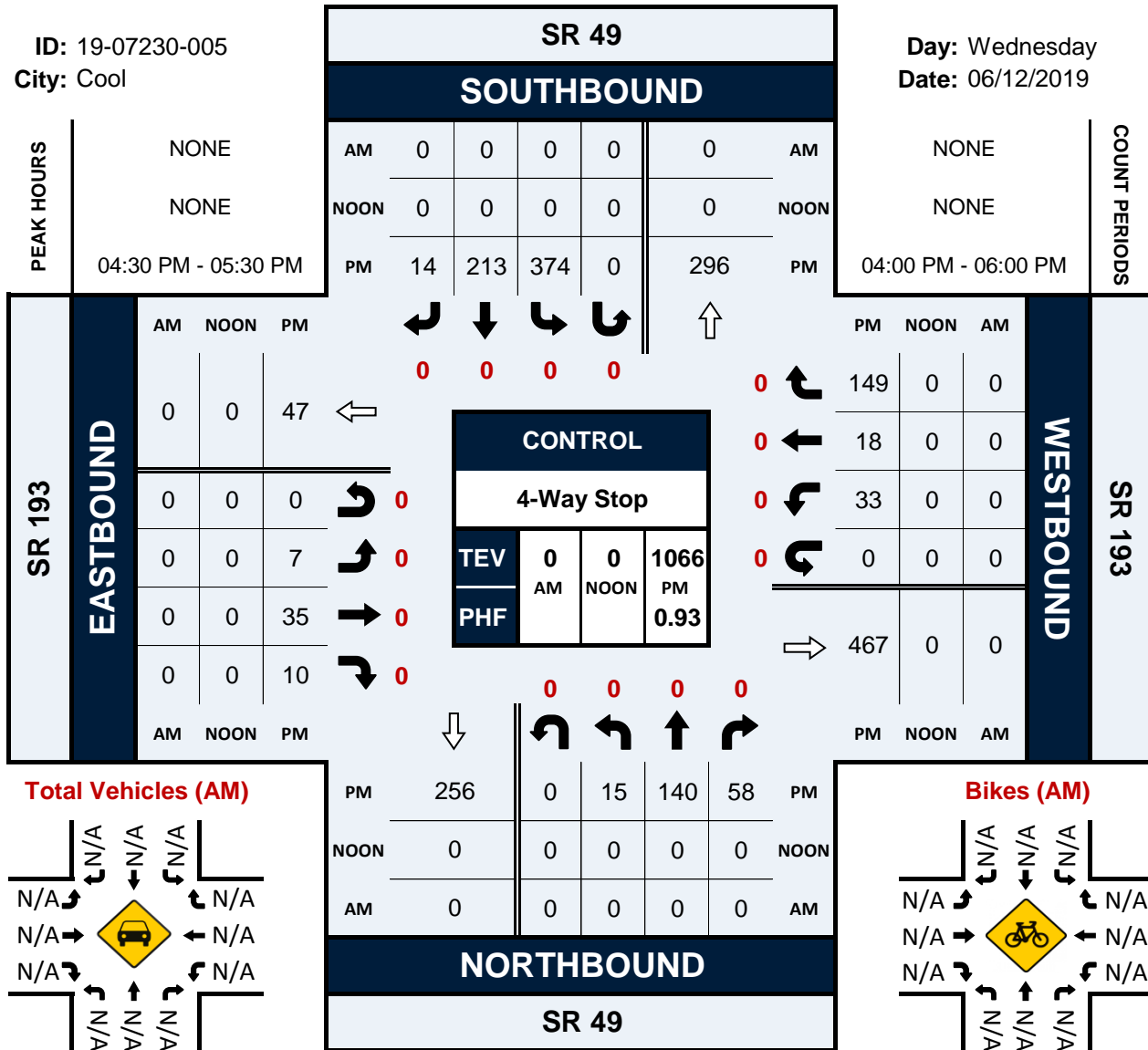

Total Vehicles (AM)

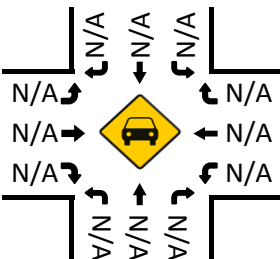

Bikes (AM)

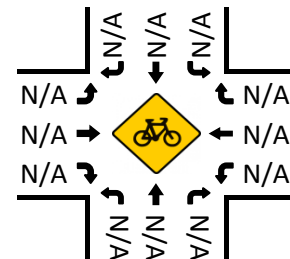

Total Vehicles (Noon)

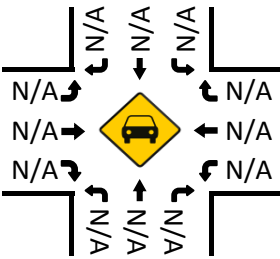

Bikes (NOON)

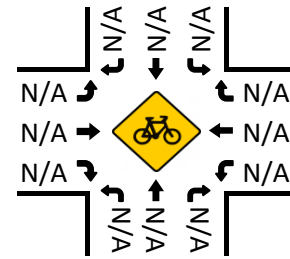

Total Vehicles (PM)

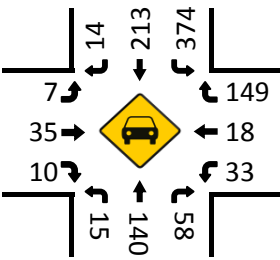

Bikes (PM)

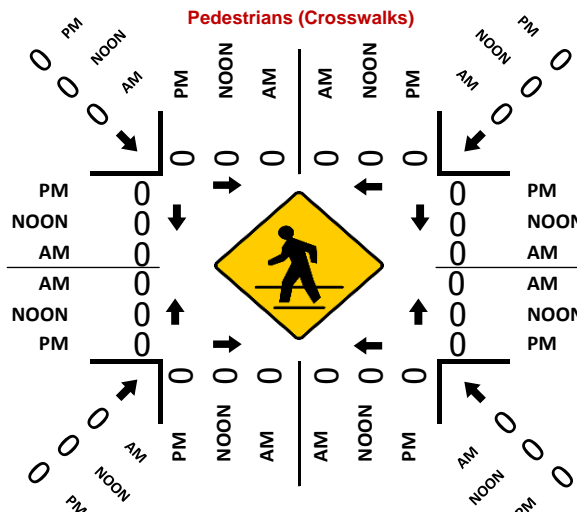
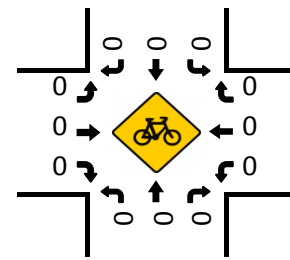

National Data & Surveying Services

Intersection Turning Movement Count

Location: SR 49 & SR 193
 City: Cool
 Control: 4-Way Stop

Project ID: 19-07230-005
 Date: 6/12/2019

Total

NS/EW Streets:	SR 49				SR 49				SR 193				SR 193				TOTAL
	NORTHBOUND				SOUTHBOUND				EASTBOUND				WESTBOUND				
PM	0	0	0	0	0	0	0	0	0	0	0	0	0	0	0	0	TOTAL
	NL	NT	NR	NU	SL	ST	SR	SU	EL	ET	ER	EU	WL	WT	WR	WU	
4:00 PM	3	21	19	0	70	42	1	0	1	3	2	0	15	3	32	0	212
4:15 PM	4	27	13	0	74	36	1	4	3	5	1	0	10	2	44	0	224
4:30 PM	3	39	15	0	95	49	4	0	1	10	3	0	13	3	40	0	275
4:45 PM	4	34	6	0	87	45	5	0	1	7	2	0	3	6	35	0	235
5:00 PM	6	34	15	0	93	53	3	0	4	9	4	0	9	7	32	0	269
5:15 PM	2	33	22	0	99	66	2	0	1	9	1	0	8	2	42	0	287
5:30 PM	5	28	14	0	92	46	3	0	2	2	6	0	11	4	30	0	243
5:45 PM	4	34	20	0	88	49	2	0	0	6	3	0	11	10	32	0	259
TOTAL VOLUMES :	NL	NT	NR	NU	SL	ST	SR	SU	EL	ET	ER	EU	WL	WT	WR	WU	TOTAL
	31	250	124	0	698	386	21	4	13	51	22	0	80	37	287	0	2004
APPROACH %'s :	7.65%	61.73%	30.62%	0.00%	62.94%	34.81%	1.89%	0.36%	15.12%	59.30%	25.58%	0.00%	19.80%	9.16%	71.04%	0.00%	
PEAK HR :	04:30 PM - 05:30 PM																TOTAL
PEAK HR VOL :	15	140	58	0	374	213	14	0	7	35	10	0	33	18	149	0	1066
PEAK HR FACTOR :	0.625	0.897	0.659	0.000	0.944	0.807	0.700	0.000	0.438	0.875	0.625	0.000	0.635	0.643	0.887	0.000	0.929
	0.934				0.900				0.765				0.893				

National Data & Surveying Services

Intersection Turning Movement Count

Location: SR 49 & SR 193
 City: Cool
 Control: 4-Way Stop

Project ID: 19-07230-005
 Date: 6/12/2019

Bikes

NS/EW Streets:	SR 49				SR 49				SR 193				SR 193				
PM	NORTHBOUND				SOUTHBOUND				EASTBOUND				WESTBOUND				TOTAL
	0	0	0	0	0	0	0	0	0	0	0	0	0	0	0	0	
	NL	NT	NR	NU	SL	ST	SR	SU	EL	ET	ER	EU	WL	WT	WR	WU	
4:00 PM	0	0	0	0	0	0	0	0	0	0	0	0	0	0	1	0	1
4:15 PM	0	0	0	0	0	0	0	0	0	0	0	0	0	0	0	0	0
4:30 PM	0	0	0	0	0	0	0	0	0	0	0	0	0	0	0	0	0
4:45 PM	0	0	0	0	0	0	0	0	0	0	0	0	0	0	0	0	0
5:00 PM	0	0	0	0	0	0	0	0	0	0	0	0	0	0	0	0	0
5:15 PM	0	0	0	0	0	0	0	0	0	0	0	0	0	0	0	0	0
5:30 PM	0	0	0	0	0	0	0	0	0	0	0	0	0	0	0	0	0
5:45 PM	0	0	0	0	0	0	0	0	0	0	0	0	0	0	0	0	0
TOTAL VOLUMES :	NL	NT	NR	NU	SL	ST	SR	SU	EL	ET	ER	EU	WL	WT	WR	WU	TOTAL
APPROACH %'s :	0	0	0	0	0	0	0	0	0	0	0	0	0	0	1	0	1
													0.00%	0.00%	100.00%	0.00%	
PEAK HR :	04:30 PM - 05:30 PM																TOTAL
PEAK HR VOL :	0	0	0	0	0	0	0	0	0	0	0	0	0	0	0	0	0
PEAK HR FACTOR :	0.00	0.000	0.000	0.000	0.000	0.000	0.000	0.000	0.000	0.000	0.000	0.000	0.000	0.000	0.000	0.000	0

National Data & Surveying Services

Intersection Turning Movement Count

Location: SR 49 & SR 193
City: Cool

Project ID: 19-07230-005
Date: 6/12/2019

Pedestrians (Crosswalks)

NS/EW Streets:	SR 49		SR 49		SR 193		SR 193		
PM	NORTH LEG		SOUTH LEG		EAST LEG		WEST LEG		TOTAL
	EB	WB	EB	WB	NB	SB	NB	SB	
4:00 PM	0	0	0	0	0	0	0	0	0
4:15 PM	0	0	0	0	0	0	0	0	0
4:30 PM	0	0	0	0	0	0	0	0	0
4:45 PM	0	0	0	0	0	0	0	0	0
5:00 PM	0	0	0	0	0	0	0	0	0
5:15 PM	0	0	0	0	0	0	0	0	0
5:30 PM	0	0	0	0	0	0	0	0	0
5:45 PM	0	0	0	0	0	0	0	0	0
TOTAL VOLUMES :	EB	WB	EB	WB	NB	SB	NB	SB	TOTAL
APPROACH %'s :	0	0	0	0	0	0	0	0	0
PEAK HR :	04:30 PM - 05:30 PM								TOTAL
PEAK HR VOL :	0	0	0	0	0	0	0	0	0
PEAK HR FACTOR :									

Intersection						
Int Delay, s/veh	0.1					
Movement	EBL	EBR	NBL	NBT	SBT	SBR
Lane Configurations	↘		↘	↑	↑	↘
Traffic Vol, veh/h	1	2	1	256	559	2
Future Vol, veh/h	1	2	1	256	559	2
Conflicting Peds, #/hr	0	0	0	0	0	0
Sign Control	Stop	Stop	Free	Free	Free	Free
RT Channelized	-	None	-	None	-	None
Storage Length	0	-	135	-	-	100
Veh in Median Storage, #	0	-	-	0	0	-
Grade, %	0	-	-	0	0	-
Peak Hour Factor	92	92	92	92	92	92
Heavy Vehicles, %	2	2	2	2	2	2
Mvmt Flow	1	2	1	278	608	2

Major/Minor	Minor2	Major1	Major2			
Conflicting Flow All	888	608	610	0	-	0
Stage 1	608	-	-	-	-	-
Stage 2	280	-	-	-	-	-
Critical Hdwy	6.42	6.22	4.12	-	-	-
Critical Hdwy Stg 1	5.42	-	-	-	-	-
Critical Hdwy Stg 2	5.42	-	-	-	-	-
Follow-up Hdwy	3.518	3.318	2.218	-	-	-
Pot Cap-1 Maneuver	314	496	969	-	-	-
Stage 1	543	-	-	-	-	-
Stage 2	767	-	-	-	-	-
Platoon blocked, %				-	-	-
Mov Cap-1 Maneuver	314	496	969	-	-	-
Mov Cap-2 Maneuver	314	-	-	-	-	-
Stage 1	542	-	-	-	-	-
Stage 2	767	-	-	-	-	-

Approach	EB	NB	SB
HCM Control Delay, s	13.7	0	0
HCM LOS	B		

Minor Lane/Major Mvmt	NBL	NBT	EBLn1	SBT	SBR
Capacity (veh/h)	969	-	416	-	-
HCM Lane V/C Ratio	0.001	-	0.008	-	-
HCM Control Delay (s)	8.7	-	13.7	-	-
HCM Lane LOS	A	-	B	-	-
HCM 95th %tile Q(veh)	0	-	0	-	-

Intersection						
Int Delay, s/veh	0.7					
Movement	WBL	WBR	NBT	NBR	SBL	SBT
Lane Configurations	Y		T		T	T
Traffic Vol, veh/h	25	7	253	20	5	556
Future Vol, veh/h	25	7	253	20	5	556
Conflicting Peds, #/hr	0	0	0	0	0	0
Sign Control	Stop	Stop	Free	Free	Free	Free
RT Channelized	-	None	-	None	-	None
Storage Length	0	-	-	-	130	-
Veh in Median Storage, #	0	-	0	-	-	0
Grade, %	0	-	0	-	-	0
Peak Hour Factor	92	92	92	92	92	92
Heavy Vehicles, %	2	2	2	2	2	2
Mvmt Flow	27	8	275	22	5	604

Major/Minor	Minor1	Major1	Major2		
Conflicting Flow All	900	286	0	0	297
Stage 1	286	-	-	-	-
Stage 2	614	-	-	-	-
Critical Hdwy	6.42	6.22	-	-	4.12
Critical Hdwy Stg 1	5.42	-	-	-	-
Critical Hdwy Stg 2	5.42	-	-	-	-
Follow-up Hdwy	3.518	3.318	-	-	2.218
Pot Cap-1 Maneuver	309	753	-	-	1264
Stage 1	763	-	-	-	-
Stage 2	540	-	-	-	-
Platoon blocked, %			-	-	-
Mov Cap-1 Maneuver	308	753	-	-	1264
Mov Cap-2 Maneuver	308	-	-	-	-
Stage 1	763	-	-	-	-
Stage 2	538	-	-	-	-

Approach	WB	NB	SB
HCM Control Delay, s	16.3	0	0.1
HCM LOS	C		

Minor Lane/Major Mvmt	NBT	NBRWBLn1	SBL	SBT
Capacity (veh/h)	-	-	354	1264
HCM Lane V/C Ratio	-	-	0.098	0.004
HCM Control Delay (s)	-	-	16.3	7.9
HCM Lane LOS	-	-	C	A
HCM 95th %tile Q(veh)	-	-	0.3	0

Intersection						
Int Delay, s/veh	1.1					
Movement	EBL	EBR	NBL	NBT	SBT	SBR
Lane Configurations						
Traffic Vol, veh/h	20	25	38	253	547	34
Future Vol, veh/h	20	25	38	253	547	34
Conflicting Peds, #/hr	0	0	0	0	0	0
Sign Control	Stop	Stop	Free	Free	Free	Free
RT Channelized	-	None	-	None	-	None
Storage Length	0	-	150	-	-	-
Veh in Median Storage, #	1	-	-	0	0	-
Grade, %	0	-	-	0	0	-
Peak Hour Factor	92	92	92	92	92	92
Heavy Vehicles, %	2	2	2	2	2	2
Mvmt Flow	22	27	41	275	595	37

Major/Minor	Minor2	Major1	Major2			
Conflicting Flow All	971	614	632	0	-	0
Stage 1	614	-	-	-	-	-
Stage 2	357	-	-	-	-	-
Critical Hdwy	6.42	6.22	4.12	-	-	-
Critical Hdwy Stg 1	5.42	-	-	-	-	-
Critical Hdwy Stg 2	5.42	-	-	-	-	-
Follow-up Hdwy	3.518	3.318	2.218	-	-	-
Pot Cap-1 Maneuver	280	492	951	-	-	-
Stage 1	540	-	-	-	-	-
Stage 2	708	-	-	-	-	-
Platoon blocked, %				-	-	-
Mov Cap-1 Maneuver	268	492	951	-	-	-
Mov Cap-2 Maneuver	390	-	-	-	-	-
Stage 1	517	-	-	-	-	-
Stage 2	708	-	-	-	-	-

Approach	EB	NB	SB
HCM Control Delay, s	14.2	1.2	0
HCM LOS	B		

Minor Lane/Major Mvmt	NBL	NBT	EBLn1	SBT	SBR
Capacity (veh/h)	951	-	441	-	-
HCM Lane V/C Ratio	0.043	-	0.111	-	-
HCM Control Delay (s)	9	-	14.2	-	-
HCM Lane LOS	A	-	B	-	-
HCM 95th %tile Q(veh)	0.1	-	0.4	-	-

Intersection	
Intersection Delay, s/veh	17.7
Intersection LOS	C

Movement	EBL	EBT	EBR	WBL	WBT	WBR	NBL	NBT	NBR	SBL	SBT	SBR
Lane Configurations		↕			↕	↕	↕	↕	↕	↕	↕	↕
Traffic Vol, veh/h	7	35	10	33	18	149	15	140	58	374	213	14
Future Vol, veh/h	7	35	10	33	18	149	15	140	58	374	213	14
Peak Hour Factor	0.92	0.92	0.92	0.92	0.92	0.92	0.92	0.92	0.92	0.92	0.92	0.92
Heavy Vehicles, %	2	2	2	2	2	2	2	2	2	2	2	2
Mvmt Flow	8	38	11	36	20	162	16	152	63	407	232	15
Number of Lanes	0	1	0	0	1	1	1	1	1	1	1	1

Approach	EB	WB	NB	SB
Opposing Approach	WB	EB	SB	NB
Opposing Lanes	2	1	3	3
Conflicting Approach Left	SB	NB	EB	WB
Conflicting Lanes Left	3	3	1	2
Conflicting Approach Right	NB	SB	WB	EB
Conflicting Lanes Right	3	3	2	1
HCM Control Delay	11.5	11.9	12	22.1
HCM LOS	B	B	B	C

Lane	NBLn1	NBLn2	NBLn3	EBLn1	WBLn1	WBLn2	SBLn1	SBLn2	SBLn3
Vol Left, %	100%	0%	0%	13%	65%	0%	100%	0%	0%
Vol Thru, %	0%	100%	0%	67%	35%	0%	0%	100%	0%
Vol Right, %	0%	0%	100%	19%	0%	100%	0%	0%	100%
Sign Control	Stop	Stop	Stop	Stop	Stop	Stop	Stop	Stop	Stop
Traffic Vol by Lane	15	140	58	52	51	149	374	213	14
LT Vol	15	0	0	7	33	0	374	0	0
Through Vol	0	140	0	35	18	0	0	213	0
RT Vol	0	0	58	10	0	149	0	0	14
Lane Flow Rate	16	152	63	57	55	162	407	232	15
Geometry Grp	8	8	8	8	8	8	8	8	8
Degree of Util (X)	0.034	0.3	0.112	0.122	0.117	0.296	0.759	0.399	0.023
Departure Headway (Hd)	7.608	7.099	6.387	7.74	7.601	6.573	6.718	6.211	5.501
Convergence, Y/N	Yes	Yes	Yes	Yes	Yes	Yes	Yes	Yes	Yes
Cap	468	502	556	466	468	543	537	576	646
Service Time	5.404	4.895	4.182	5.44	5.395	4.367	4.489	3.981	3.271
HCM Lane V/C Ratio	0.034	0.303	0.113	0.122	0.118	0.298	0.758	0.403	0.023
HCM Control Delay	10.7	12.9	10	11.5	11.4	12.1	27.8	13.1	8.4
HCM Lane LOS	B	B	A	B	B	B	D	B	A
HCM 95th-tile Q	0.1	1.3	0.4	0.4	0.4	1.2	6.7	1.9	0.1

Intersection						
Int Delay, s/veh	7.6					
Movement	EBL	EBT	WBT	WBR	SBL	SBR
Lane Configurations		↔	↔		↔	
Traffic Vol, veh/h	35	1	2	0	0	40
Future Vol, veh/h	35	1	2	0	0	40
Conflicting Peds, #/hr	0	0	0	0	0	0
Sign Control	Free	Free	Free	Free	Stop	Stop
RT Channelized	-	None	-	None	-	None
Storage Length	-	-	-	-	0	-
Veh in Median Storage, #	-	0	0	-	0	-
Grade, %	-	0	0	-	0	-
Peak Hour Factor	78	78	78	78	78	78
Heavy Vehicles, %	2	2	2	2	2	2
Mvmt Flow	45	1	3	0	0	51

Major/Minor	Major1	Major2	Minor2		
Conflicting Flow All	3	0	-	0	94
Stage 1	-	-	-	-	3
Stage 2	-	-	-	-	91
Critical Hdwy	4.12	-	-	-	6.42
Critical Hdwy Stg 1	-	-	-	-	5.42
Critical Hdwy Stg 2	-	-	-	-	5.42
Follow-up Hdwy	2.218	-	-	-	3.518
Pot Cap-1 Maneuver	1619	-	-	-	906
Stage 1	-	-	-	-	1020
Stage 2	-	-	-	-	933
Platoon blocked, %		-	-	-	
Mov Cap-1 Maneuver	1619	-	-	-	881
Mov Cap-2 Maneuver	-	-	-	-	881
Stage 1	-	-	-	-	991
Stage 2	-	-	-	-	933

Approach	EB	WB	SB
HCM Control Delay, s	7.1	0	8.5
HCM LOS			A

Minor Lane/Major Mvmt	EBL	EBT	WBT	WBR	SBLn1
Capacity (veh/h)	1619	-	-	-	1081
HCM Lane V/C Ratio	0.028	-	-	-	0.047
HCM Control Delay (s)	7.3	0	-	-	8.5
HCM Lane LOS	A	A	-	-	A
HCM 95th %tile Q(veh)	0.1	-	-	-	0.1

Intersection						
Int Delay, s/veh	0.1					
Movement	EBL	EBR	NBL	NBT	SBT	SBR
Lane Configurations	↘↗		↘	↑	↑	↘
Traffic Vol, veh/h	1	2	1	258	561	2
Future Vol, veh/h	1	2	1	258	561	2
Conflicting Peds, #/hr	0	0	0	0	0	0
Sign Control	Stop	Stop	Free	Free	Free	Free
RT Channelized	-	None	-	None	-	None
Storage Length	0	-	135	-	-	100
Veh in Median Storage, #	0	-	-	0	0	-
Grade, %	0	-	-	0	0	-
Peak Hour Factor	92	92	92	92	92	92
Heavy Vehicles, %	2	2	2	2	2	2
Mvmt Flow	1	2	1	280	610	2

Major/Minor	Minor2	Major1	Major2			
Conflicting Flow All	892	610	612	0	-	0
Stage 1	610	-	-	-	-	-
Stage 2	282	-	-	-	-	-
Critical Hdwy	6.42	6.22	4.12	-	-	-
Critical Hdwy Stg 1	5.42	-	-	-	-	-
Critical Hdwy Stg 2	5.42	-	-	-	-	-
Follow-up Hdwy	3.518	3.318	2.218	-	-	-
Pot Cap-1 Maneuver	312	494	967	-	-	-
Stage 1	542	-	-	-	-	-
Stage 2	766	-	-	-	-	-
Platoon blocked, %				-	-	-
Mov Cap-1 Maneuver	312	494	967	-	-	-
Mov Cap-2 Maneuver	312	-	-	-	-	-
Stage 1	541	-	-	-	-	-
Stage 2	766	-	-	-	-	-

Approach	EB	NB	SB
HCM Control Delay, s	13.8	0	0
HCM LOS	B		

Minor Lane/Major Mvmt	NBL	NBT	EBLn1	SBT	SBR
Capacity (veh/h)	967	-	414	-	-
HCM Lane V/C Ratio	0.001	-	0.008	-	-
HCM Control Delay (s)	8.7	-	13.8	-	-
HCM Lane LOS	A	-	B	-	-
HCM 95th %tile Q(veh)	0	-	0	-	-

Intersection						
Int Delay, s/veh	1.4					
Movement	WBL	WBR	NBT	NBR	SBL	SBT
Lane Configurations	Y		T		T	T
Traffic Vol, veh/h	50	12	250	43	14	549
Future Vol, veh/h	50	12	250	43	14	549
Conflicting Peds, #/hr	0	0	0	0	0	0
Sign Control	Stop	Stop	Free	Free	Free	Free
RT Channelized	-	None	-	None	-	None
Storage Length	0	-	-	-	130	-
Veh in Median Storage, #	0	-	0	-	-	0
Grade, %	0	-	0	-	-	0
Peak Hour Factor	92	92	92	92	92	92
Heavy Vehicles, %	2	2	2	2	2	2
Mvmt Flow	54	13	272	47	15	597

Major/Minor	Minor1	Major1	Major2		
Conflicting Flow All	923	296	0	0	319
Stage 1	296	-	-	-	-
Stage 2	627	-	-	-	-
Critical Hdwy	6.42	6.22	-	-	4.12
Critical Hdwy Stg 1	5.42	-	-	-	-
Critical Hdwy Stg 2	5.42	-	-	-	-
Follow-up Hdwy	3.518	3.318	-	-	2.218
Pot Cap-1 Maneuver	299	743	-	-	1241
Stage 1	755	-	-	-	-
Stage 2	532	-	-	-	-
Platoon blocked, %			-	-	-
Mov Cap-1 Maneuver	295	743	-	-	1241
Mov Cap-2 Maneuver	295	-	-	-	-
Stage 1	755	-	-	-	-
Stage 2	526	-	-	-	-

Approach	WB	NB	SB
HCM Control Delay, s	18.5	0	0.2
HCM LOS	C		

Minor Lane/Major Mvmt	NBT	NBRWBLn1	SBL	SBT
Capacity (veh/h)	-	-	334	1241
HCM Lane V/C Ratio	-	-	0.202	0.012
HCM Control Delay (s)	-	-	18.5	7.9
HCM Lane LOS	-	-	C	A
HCM 95th %tile Q(veh)	-	-	0.7	0

Intersection						
Int Delay, s/veh	1.1					
Movement	EBL	EBR	NBL	NBT	SBT	SBR
Lane Configurations						
Traffic Vol, veh/h	22	25	38	271	563	36
Future Vol, veh/h	22	25	38	271	563	36
Conflicting Peds, #/hr	0	0	0	0	0	0
Sign Control	Stop	Stop	Free	Free	Free	Free
RT Channelized	-	None	-	None	-	None
Storage Length	0	-	150	-	-	-
Veh in Median Storage, #	1	-	-	0	0	-
Grade, %	0	-	-	0	0	-
Peak Hour Factor	92	92	92	92	92	92
Heavy Vehicles, %	2	2	2	2	2	2
Mvmt Flow	24	27	41	295	612	39

Major/Minor	Minor2	Major1	Major2			
Conflicting Flow All	1009	632	651	0	-	0
Stage 1	632	-	-	-	-	-
Stage 2	377	-	-	-	-	-
Critical Hdwy	6.42	6.22	4.12	-	-	-
Critical Hdwy Stg 1	5.42	-	-	-	-	-
Critical Hdwy Stg 2	5.42	-	-	-	-	-
Follow-up Hdwy	3.518	3.318	2.218	-	-	-
Pot Cap-1 Maneuver	266	480	935	-	-	-
Stage 1	530	-	-	-	-	-
Stage 2	694	-	-	-	-	-
Platoon blocked, %				-	-	-
Mov Cap-1 Maneuver	254	480	935	-	-	-
Mov Cap-2 Maneuver	378	-	-	-	-	-
Stage 1	507	-	-	-	-	-
Stage 2	694	-	-	-	-	-

Approach	EB	NB	SB
HCM Control Delay, s	14.6	1.1	0
HCM LOS	B		

Minor Lane/Major Mvmt	NBL	NBT	EBLn1	SBT	SBR
Capacity (veh/h)	935	-	426	-	-
HCM Lane V/C Ratio	0.044	-	0.12	-	-
HCM Control Delay (s)	9	-	14.6	-	-
HCM Lane LOS	A	-	B	-	-
HCM 95th %tile Q(veh)	0.1	-	0.4	-	-

Intersection	
Intersection Delay, s/veh	18.8
Intersection LOS	C

Movement	EBL	EBT	EBR	WBL	WBT	WBR	NBL	NBT	NBR	SBL	SBT	SBR
Lane Configurations		↕↔			↕	↕	↕	↕	↕	↕	↕	↕
Traffic Vol, veh/h	7	35	10	33	18	158	15	149	58	382	221	14
Future Vol, veh/h	7	35	10	33	18	158	15	149	58	382	221	14
Peak Hour Factor	0.92	0.92	0.92	0.92	0.92	0.92	0.92	0.92	0.92	0.92	0.92	0.92
Heavy Vehicles, %	2	2	2	2	2	2	2	2	2	2	2	2
Mvmt Flow	8	38	11	36	20	172	16	162	63	415	240	15
Number of Lanes	0	1	0	0	1	1	1	1	1	1	1	1

Approach	EB	WB	NB	SB
Opposing Approach	WB	EB	SB	NB
Opposing Lanes	2	1	3	3
Conflicting Approach Left	SB	NB	EB	WB
Conflicting Lanes Left	3	3	1	2
Conflicting Approach Right	NB	SB	WB	EB
Conflicting Lanes Right	3	3	2	1
HCM Control Delay	11.7	12.4	12.5	23.8
HCM LOS	B	B	B	C

Lane	NBLn1	NBLn2	NBLn3	EBLn1	WBLn1	WBLn2	SBLn1	SBLn2	SBLn3
Vol Left, %	100%	0%	0%	13%	65%	0%	100%	0%	0%
Vol Thru, %	0%	100%	0%	67%	35%	0%	0%	100%	0%
Vol Right, %	0%	0%	100%	19%	0%	100%	0%	0%	100%
Sign Control	Stop	Stop	Stop	Stop	Stop	Stop	Stop	Stop	Stop
Traffic Vol by Lane	15	149	58	52	51	158	382	221	14
LT Vol	15	0	0	7	33	0	382	0	0
Through Vol	0	149	0	35	18	0	0	221	0
RT Vol	0	0	58	10	0	158	0	0	14
Lane Flow Rate	16	162	63	57	55	172	415	240	15
Geometry Grp	8	8	8	8	8	8	8	8	8
Degree of Util (X)	0.035	0.328	0.115	0.124	0.12	0.323	0.784	0.42	0.024
Departure Headway (Hd)	7.802	7.292	6.579	7.874	7.791	6.775	6.898	6.39	5.679
Convergence, Y/N	Yes	Yes	Yes	Yes	Yes	Yes	Yes	Yes	Yes
Cap	461	496	547	457	462	534	527	567	634
Service Time	5.52	5.01	4.297	5.595	5.504	4.475	4.598	4.09	3.379
HCM Lane V/C Ratio	0.035	0.327	0.115	0.125	0.119	0.322	0.787	0.423	0.024
HCM Control Delay	10.8	13.5	10.2	11.7	11.6	12.7	30.2	13.6	8.5
HCM Lane LOS	B	B	B	B	B	B	D	B	A
HCM 95th-tile Q	0.1	1.4	0.4	0.4	0.4	1.4	7.2	2.1	0.1

Intersection						
Int Delay, s/veh	4.3					
Movement	EBL	EBT	WBT	WBR	SBL	SBR
Lane Configurations		↔	↔		↔	
Traffic Vol, veh/h	35	33	32	0	0	40
Future Vol, veh/h	35	33	32	0	0	40
Conflicting Peds, #/hr	0	0	0	0	0	0
Sign Control	Free	Free	Free	Free	Stop	Stop
RT Channelized	-	None	-	None	-	None
Storage Length	-	-	-	-	0	-
Veh in Median Storage, #	-	0	0	-	0	-
Grade, %	-	0	0	-	0	-
Peak Hour Factor	78	78	78	78	78	78
Heavy Vehicles, %	2	2	2	2	2	2
Mvmt Flow	45	42	41	0	0	51

Major/Minor	Major1	Major2	Minor2		
Conflicting Flow All	41	0	-	0	173 41
Stage 1	-	-	-	-	41 -
Stage 2	-	-	-	-	132 -
Critical Hdwy	4.12	-	-	-	6.42 6.22
Critical Hdwy Stg 1	-	-	-	-	5.42 -
Critical Hdwy Stg 2	-	-	-	-	5.42 -
Follow-up Hdwy	2.218	-	-	-	3.518 3.318
Pot Cap-1 Maneuver	1568	-	-	-	817 1030
Stage 1	-	-	-	-	981 -
Stage 2	-	-	-	-	894 -
Platoon blocked, %		-	-	-	
Mov Cap-1 Maneuver	1568	-	-	-	793 1030
Mov Cap-2 Maneuver	-	-	-	-	793 -
Stage 1	-	-	-	-	953 -
Stage 2	-	-	-	-	894 -

Approach	EB	WB	SB
HCM Control Delay, s	3.8	0	8.7
HCM LOS			A

Minor Lane/Major Mvmt	EBL	EBT	WBT	WBR	SBLn1
Capacity (veh/h)	1568	-	-	-	1030
HCM Lane V/C Ratio	0.029	-	-	-	0.05
HCM Control Delay (s)	7.4	0	-	-	8.7
HCM Lane LOS	A	A	-	-	A
HCM 95th %tile Q(veh)	0.1	-	-	-	0.2

Intersection						
Int Delay, s/veh	4.1					
Movement	EBT	EBR	WBL	WBT	NBL	NBR
Lane Configurations						
Traffic Vol, veh/h	0	32	0	2	30	0
Future Vol, veh/h	0	32	0	2	30	0
Conflicting Peds, #/hr	0	0	0	0	0	0
Sign Control	Free	Free	Free	Free	Stop	Stop
RT Channelized	-	None	-	None	-	None
Storage Length	-	-	-	-	0	-
Veh in Median Storage, #	0	-	-	0	0	-
Grade, %	0	-	-	0	0	-
Peak Hour Factor	92	92	92	92	92	92
Heavy Vehicles, %	2	2	2	2	2	2
Mvmt Flow	0	35	0	2	33	0

Major/Minor	Major1	Major2	Minor1	Minor2	Minor3
Conflicting Flow All	0	0	35	0	20
Stage 1	-	-	-	-	18
Stage 2	-	-	-	-	2
Critical Hdwy	-	-	4.12	-	6.42
Critical Hdwy Stg 1	-	-	-	-	5.42
Critical Hdwy Stg 2	-	-	-	-	5.42
Follow-up Hdwy	-	-	2.218	-	3.518
Pot Cap-1 Maneuver	-	-	1576	-	997
Stage 1	-	-	-	-	1005
Stage 2	-	-	-	-	1021
Platoon blocked, %	-	-	-	-	-
Mov Cap-1 Maneuver	-	-	1576	-	997
Mov Cap-2 Maneuver	-	-	-	-	997
Stage 1	-	-	-	-	1005
Stage 2	-	-	-	-	1021

Approach	EB	WB	NB
HCM Control Delay, s	0	0	8.7
HCM LOS			A

Minor Lane/Major Mvmt	NBLn1	EBT	EBR	WBL	WBT
Capacity (veh/h)	997	-	-	1576	-
HCM Lane V/C Ratio	0.033	-	-	-	-
HCM Control Delay (s)	8.7	-	-	0	-
HCM Lane LOS	A	-	-	A	-
HCM 95th %tile Q(veh)	0.1	-	-	0	-

Intersection						
Int Delay, s/veh	0.9					
Movement	EBL	EBR	NBL	NBT	SBT	SBR
Lane Configurations	↔		↔	↑	↑	↔
Traffic Vol, veh/h	15	30	15	370	665	25
Future Vol, veh/h	15	30	15	370	665	25
Conflicting Peds, #/hr	0	0	0	0	0	0
Sign Control	Stop	Stop	Free	Free	Free	Free
RT Channelized	-	None	-	None	-	None
Storage Length	0	-	135	-	-	100
Veh in Median Storage, #	0	-	-	0	0	-
Grade, %	0	-	-	0	0	-
Peak Hour Factor	92	92	92	92	92	92
Heavy Vehicles, %	2	2	2	2	2	2
Mvmt Flow	16	33	16	402	723	27

Major/Minor	Minor2	Major1	Major2			
Conflicting Flow All	1157	723	750	0	-	0
Stage 1	723	-	-	-	-	-
Stage 2	434	-	-	-	-	-
Critical Hdwy	6.42	6.22	4.12	-	-	-
Critical Hdwy Stg 1	5.42	-	-	-	-	-
Critical Hdwy Stg 2	5.42	-	-	-	-	-
Follow-up Hdwy	3.518	3.318	2.218	-	-	-
Pot Cap-1 Maneuver	217	426	859	-	-	-
Stage 1	481	-	-	-	-	-
Stage 2	653	-	-	-	-	-
Platoon blocked, %				-	-	-
Mov Cap-1 Maneuver	213	426	859	-	-	-
Mov Cap-2 Maneuver	213	-	-	-	-	-
Stage 1	472	-	-	-	-	-
Stage 2	653	-	-	-	-	-

Approach	EB	NB	SB
HCM Control Delay, s	18.3	0.4	0
HCM LOS	C		

Minor Lane/Major Mvmt	NBL	NBT	EBLn1	SBT	SBR
Capacity (veh/h)	859	-	320	-	-
HCM Lane V/C Ratio	0.019	-	0.153	-	-
HCM Control Delay (s)	9.3	-	18.3	-	-
HCM Lane LOS	A	-	C	-	-
HCM 95th %tile Q(veh)	0.1	-	0.5	-	-

Intersection						
Int Delay, s/veh	0.7					
Movement	WBL	WBR	NBT	NBR	SBL	SBT
Lane Configurations	Y		B		Y	↑
Traffic Vol, veh/h	25	10	375	20	5	690
Future Vol, veh/h	25	10	375	20	5	690
Conflicting Peds, #/hr	0	0	0	0	0	0
Sign Control	Stop	Stop	Free	Free	Free	Free
RT Channelized	-	None	-	None	-	None
Storage Length	0	-	-	-	130	-
Veh in Median Storage, #	0	-	0	-	-	0
Grade, %	0	-	0	-	-	0
Peak Hour Factor	92	92	92	92	92	92
Heavy Vehicles, %	2	2	2	2	2	2
Mvmt Flow	27	11	408	22	5	750

Major/Minor	Minor1	Major1	Major2		
Conflicting Flow All	1179	419	0	0	430
Stage 1	419	-	-	-	-
Stage 2	760	-	-	-	-
Critical Hdwy	6.42	6.22	-	-	4.12
Critical Hdwy Stg 1	5.42	-	-	-	-
Critical Hdwy Stg 2	5.42	-	-	-	-
Follow-up Hdwy	3.518	3.318	-	-	2.218
Pot Cap-1 Maneuver	211	634	-	-	1129
Stage 1	664	-	-	-	-
Stage 2	462	-	-	-	-
Platoon blocked, %			-	-	-
Mov Cap-1 Maneuver	210	634	-	-	1129
Mov Cap-2 Maneuver	210	-	-	-	-
Stage 1	664	-	-	-	-
Stage 2	460	-	-	-	-

Approach	WB	NB	SB
HCM Control Delay, s	21.2	0	0.1
HCM LOS	C		

Minor Lane/Major Mvmt	NBT	NBRWBLn1	SBL	SBT
Capacity (veh/h)	-	-	260	1129
HCM Lane V/C Ratio	-	-	0.146	0.005
HCM Control Delay (s)	-	-	21.2	8.2
HCM Lane LOS	-	-	C	A
HCM 95th %tile Q(veh)	-	-	0.5	0

Intersection						
Int Delay, s/veh	1					
Movement	EBL	EBR	NBL	NBT	SBT	SBR
Lane Configurations						
Traffic Vol, veh/h	20	25	40	375	680	35
Future Vol, veh/h	20	25	40	375	680	35
Conflicting Peds, #/hr	0	0	0	0	0	0
Sign Control	Stop	Stop	Free	Free	Free	Free
RT Channelized	-	None	-	None	-	None
Storage Length	0	-	150	-	-	-
Veh in Median Storage, #	1	-	-	0	0	-
Grade, %	0	-	-	0	0	-
Peak Hour Factor	92	92	92	92	92	92
Heavy Vehicles, %	2	2	2	2	2	2
Mvmt Flow	22	27	43	408	739	38

Major/Minor	Minor2	Major1	Major2			
Conflicting Flow All	1252	758	777	0	-	0
Stage 1	758	-	-	-	-	-
Stage 2	494	-	-	-	-	-
Critical Hdwy	6.42	6.22	4.12	-	-	-
Critical Hdwy Stg 1	5.42	-	-	-	-	-
Critical Hdwy Stg 2	5.42	-	-	-	-	-
Follow-up Hdwy	3.518	3.318	2.218	-	-	-
Pot Cap-1 Maneuver	190	407	839	-	-	-
Stage 1	463	-	-	-	-	-
Stage 2	613	-	-	-	-	-
Platoon blocked, %				-	-	-
Mov Cap-1 Maneuver	180	407	839	-	-	-
Mov Cap-2 Maneuver	312	-	-	-	-	-
Stage 1	439	-	-	-	-	-
Stage 2	613	-	-	-	-	-

Approach	EB	NB	SB
HCM Control Delay, s	16.6	0.9	0
HCM LOS	C		

Minor Lane/Major Mvmt	NBL	NBT	EBLn1	SBT	SBR
Capacity (veh/h)	839	-	358	-	-
HCM Lane V/C Ratio	0.052	-	0.137	-	-
HCM Control Delay (s)	9.5	-	16.6	-	-
HCM Lane LOS	A	-	C	-	-
HCM 95th %tile Q(veh)	0.2	-	0.5	-	-

Intersection	
Intersection Delay, s/veh	30.6
Intersection LOS	D

Movement	EBL	EBT	EBR	WBL	WBT	WBR	NBL	NBT	NBR	SBL	SBT	SBR
Lane Configurations		↕↔			↕	↕	↕	↕	↕	↕	↕	↕
Traffic Vol, veh/h	10	35	15	40	15	185	20	230	75	420	300	15
Future Vol, veh/h	10	35	15	40	15	185	20	230	75	420	300	15
Peak Hour Factor	0.92	0.92	0.92	0.92	0.92	0.92	0.92	0.92	0.92	0.92	0.92	0.92
Heavy Vehicles, %	2	2	2	2	2	2	2	2	2	2	2	2
Mvmt Flow	11	38	16	43	16	201	22	250	82	457	326	16
Number of Lanes	0	1	0	0	1	1	1	1	1	1	1	1

Approach	EB	WB	NB	SB
Opposing Approach	WB	EB	SB	NB
Opposing Lanes	2	1	3	3
Conflicting Approach Left	SB	NB	EB	WB
Conflicting Lanes Left	3	3	1	2
Conflicting Approach Right	NB	SB	WB	EB
Conflicting Lanes Right	3	3	2	1
HCM Control Delay	13.4	15.2	17.6	42.8
HCM LOS	B	C	C	E

Lane	NBLn1	NBLn2	NBLn3	EBLn1	WBLn1	WBLn2	SBLn1	SBLn2	SBLn3
Vol Left, %	100%	0%	0%	17%	73%	0%	100%	0%	0%
Vol Thru, %	0%	100%	0%	58%	27%	0%	0%	100%	0%
Vol Right, %	0%	0%	100%	25%	0%	100%	0%	0%	100%
Sign Control	Stop	Stop	Stop	Stop	Stop	Stop	Stop	Stop	Stop
Traffic Vol by Lane	20	230	75	60	55	185	420	300	15
LT Vol	20	0	0	10	40	0	420	0	0
Through Vol	0	230	0	35	15	0	0	300	0
RT Vol	0	0	75	15	0	185	0	0	15
Lane Flow Rate	22	250	82	65	60	201	457	326	16
Geometry Grp	8	8	8	8	8	8	8	8	8
Degree of Util (X)	0.051	0.553	0.164	0.161	0.144	0.425	0.959	0.639	0.029
Departure Headway (Hd)	8.473	7.961	7.243	8.866	8.686	7.609	7.562	7.051	6.336
Convergence, Y/N	Yes	Yes	Yes	Yes	Yes	Yes	Yes	Yes	Yes
Cap	422	453	494	404	412	473	479	512	564
Service Time	6.235	5.722	5.004	6.644	6.449	5.371	5.315	4.804	4.089
HCM Lane V/C Ratio	0.052	0.552	0.166	0.161	0.146	0.425	0.954	0.637	0.028
HCM Control Delay	11.7	20.2	11.4	13.4	12.9	15.9	59.2	21.5	9.3
HCM Lane LOS	B	C	B	B	B	C	F	C	A
HCM 95th-tile Q	0.2	3.3	0.6	0.6	0.5	2.1	11.9	4.4	0.1

Intersection						
Int Delay, s/veh	7					
Movement	EBL	EBT	WBT	WBR	SBL	SBR
Lane Configurations		↕	↕		↕	
Traffic Vol, veh/h	35	5	5	0	0	40
Future Vol, veh/h	35	5	5	0	0	40
Conflicting Peds, #/hr	0	0	0	0	0	0
Sign Control	Free	Free	Free	Free	Stop	Stop
RT Channelized	-	None	-	None	-	None
Storage Length	-	-	-	-	0	-
Veh in Median Storage, #	-	0	0	-	0	-
Grade, %	-	0	0	-	0	-
Peak Hour Factor	78	78	78	78	78	78
Heavy Vehicles, %	2	2	2	2	2	2
Mvmt Flow	45	6	6	0	0	51

Major/Minor	Major1	Major2	Minor2		
Conflicting Flow All	6	0	-	0	102 6
Stage 1	-	-	-	-	6 -
Stage 2	-	-	-	-	96 -
Critical Hdwy	4.12	-	-	-	6.42 6.22
Critical Hdwy Stg 1	-	-	-	-	5.42 -
Critical Hdwy Stg 2	-	-	-	-	5.42 -
Follow-up Hdwy	2.218	-	-	-	3.518 3.318
Pot Cap-1 Maneuver	1615	-	-	-	896 1077
Stage 1	-	-	-	-	1017 -
Stage 2	-	-	-	-	928 -
Platoon blocked, %		-	-	-	
Mov Cap-1 Maneuver	1615	-	-	-	871 1077
Mov Cap-2 Maneuver	-	-	-	-	871 -
Stage 1	-	-	-	-	989 -
Stage 2	-	-	-	-	928 -

Approach	EB	WB	SB
HCM Control Delay, s	6.4	0	8.5
HCM LOS			A

Minor Lane/Major Mvmt	EBL	EBT	WBT	WBR	SBLn1
Capacity (veh/h)	1615	-	-	-	1077
HCM Lane V/C Ratio	0.028	-	-	-	0.048
HCM Control Delay (s)	7.3	0	-	-	8.5
HCM Lane LOS	A	A	-	-	A
HCM 95th %tile Q(veh)	0.1	-	-	-	0.1

Intersection						
Int Delay, s/veh	0					
Movement	EBT	EBR	WBL	WBT	NBL	NBR
Lane Configurations	↔			↔	↔	
Traffic Vol, veh/h	5	0	0	5	0	0
Future Vol, veh/h	5	0	0	5	0	0
Conflicting Peds, #/hr	0	0	0	0	0	0
Sign Control	Free	Free	Free	Free	Stop	Stop
RT Channelized	-	None	-	None	-	None
Storage Length	-	-	-	-	0	-
Veh in Median Storage, #	0	-	-	0	0	-
Grade, %	0	-	-	0	0	-
Peak Hour Factor	92	92	92	92	92	92
Heavy Vehicles, %	2	2	2	2	2	2
Mvmt Flow	5	0	0	5	0	0

Major/Minor	Major1	Major2	Minor1		
Conflicting Flow All	0	0	5	0	10
Stage 1	-	-	-	-	5
Stage 2	-	-	-	-	5
Critical Hdwy	-	-	4.12	-	6.42
Critical Hdwy Stg 1	-	-	-	-	5.42
Critical Hdwy Stg 2	-	-	-	-	5.42
Follow-up Hdwy	-	-	2.218	-	3.518
Pot Cap-1 Maneuver	-	-	1616	-	1010
Stage 1	-	-	-	-	1018
Stage 2	-	-	-	-	1018
Platoon blocked, %	-	-	-	-	-
Mov Cap-1 Maneuver	-	-	1616	-	1010
Mov Cap-2 Maneuver	-	-	-	-	1010
Stage 1	-	-	-	-	1018
Stage 2	-	-	-	-	1018

Approach	EB	WB	NB
HCM Control Delay, s	0	0	0
HCM LOS			A

Minor Lane/Major Mvmt	NBLn1	EBT	EBR	WBL	WBT
Capacity (veh/h)	-	-	-	1616	-
HCM Lane V/C Ratio	-	-	-	-	-
HCM Control Delay (s)	0	-	-	0	-
HCM Lane LOS	A	-	-	A	-
HCM 95th %tile Q(veh)	-	-	-	0	-

Intersection						
Int Delay, s/veh	0.9					
Movement	EBL	EBR	NBL	NBT	SBT	SBR
Lane Configurations	↘		↘	↑	↑	↘
Traffic Vol, veh/h	15	30	15	372	667	25
Future Vol, veh/h	15	30	15	372	667	25
Conflicting Peds, #/hr	0	0	0	0	0	0
Sign Control	Stop	Stop	Free	Free	Free	Free
RT Channelized	-	None	-	None	-	None
Storage Length	0	-	135	-	-	100
Veh in Median Storage, #	0	-	-	0	0	-
Grade, %	0	-	-	0	0	-
Peak Hour Factor	92	92	92	92	92	92
Heavy Vehicles, %	2	2	2	2	2	2
Mvmt Flow	16	33	16	404	725	27

Major/Minor	Minor2	Major1	Major2			
Conflicting Flow All	1161	725	752	0	-	0
Stage 1	725	-	-	-	-	-
Stage 2	436	-	-	-	-	-
Critical Hdwy	6.42	6.22	4.12	-	-	-
Critical Hdwy Stg 1	5.42	-	-	-	-	-
Critical Hdwy Stg 2	5.42	-	-	-	-	-
Follow-up Hdwy	3.518	3.318	2.218	-	-	-
Pot Cap-1 Maneuver	216	425	858	-	-	-
Stage 1	479	-	-	-	-	-
Stage 2	652	-	-	-	-	-
Platoon blocked, %				-	-	-
Mov Cap-1 Maneuver	212	425	858	-	-	-
Mov Cap-2 Maneuver	212	-	-	-	-	-
Stage 1	470	-	-	-	-	-
Stage 2	652	-	-	-	-	-

Approach	EB	NB	SB
HCM Control Delay, s	18.4	0.4	0
HCM LOS	C		

Minor Lane/Major Mvmt	NBL	NBT	EBLn1	SBT	SBR
Capacity (veh/h)	858	-	318	-	-
HCM Lane V/C Ratio	0.019	-	0.154	-	-
HCM Control Delay (s)	9.3	-	18.4	-	-
HCM Lane LOS	A	-	C	-	-
HCM 95th %tile Q(veh)	0.1	-	0.5	-	-

Intersection						
Int Delay, s/veh	1.5					
Movement	WBL	WBR	NBT	NBR	SBL	SBT
Lane Configurations	↔		↔		↔	↔
Traffic Vol, veh/h	48	17	370	45	13	684
Future Vol, veh/h	48	17	370	45	13	684
Conflicting Peds, #/hr	0	0	0	0	0	0
Sign Control	Stop	Stop	Free	Free	Free	Free
RT Channelized	-	None	-	None	-	None
Storage Length	0	-	-	-	130	-
Veh in Median Storage, #	0	-	0	-	-	0
Grade, %	0	-	0	-	-	0
Peak Hour Factor	92	92	92	92	92	92
Heavy Vehicles, %	2	2	2	2	2	2
Mvmt Flow	52	18	402	49	14	743

Major/Minor	Minor1	Major1	Major2		
Conflicting Flow All	1198	427	0	0	451
Stage 1	427	-	-	-	-
Stage 2	771	-	-	-	-
Critical Hdwy	6.42	6.22	-	-	4.12
Critical Hdwy Stg 1	5.42	-	-	-	-
Critical Hdwy Stg 2	5.42	-	-	-	-
Follow-up Hdwy	3.518	3.318	-	-	2.218
Pot Cap-1 Maneuver	205	628	-	-	1109
Stage 1	658	-	-	-	-
Stage 2	456	-	-	-	-
Platoon blocked, %			-	-	-
Mov Cap-1 Maneuver	202	628	-	-	1109
Mov Cap-2 Maneuver	202	-	-	-	-
Stage 1	658	-	-	-	-
Stage 2	450	-	-	-	-

Approach	WB	NB	SB
HCM Control Delay, s	25.4	0	0.2
HCM LOS	D		

Minor Lane/Major Mvmt	NBT	NBRWBLn1	SBL	SBT
Capacity (veh/h)	-	-	246	1109
HCM Lane V/C Ratio	-	-	0.287	0.013
HCM Control Delay (s)	-	-	25.4	8.3
HCM Lane LOS	-	-	D	A
HCM 95th %tile Q(veh)	-	-	1.1	0

Intersection						
Int Delay, s/veh	1					
Movement	EBL	EBR	NBL	NBT	SBT	SBR
Lane Configurations	WT		WT	↑	↑	
Traffic Vol, veh/h	22	25	40	393	696	37
Future Vol, veh/h	22	25	40	393	696	37
Conflicting Peds, #/hr	0	0	0	0	0	0
Sign Control	Stop	Stop	Free	Free	Free	Free
RT Channelized	-	None	-	None	-	None
Storage Length	0	-	150	-	-	-
Veh in Median Storage, #	1	-	-	0	0	-
Grade, %	0	-	-	0	0	-
Peak Hour Factor	92	92	92	92	92	92
Heavy Vehicles, %	2	2	2	2	2	2
Mvmt Flow	24	27	43	427	757	40

Major/Minor	Minor2	Major1	Major2			
Conflicting Flow All	1290	777	797	0	-	0
Stage 1	777	-	-	-	-	-
Stage 2	513	-	-	-	-	-
Critical Hdwy	6.42	6.22	4.12	-	-	-
Critical Hdwy Stg 1	5.42	-	-	-	-	-
Critical Hdwy Stg 2	5.42	-	-	-	-	-
Follow-up Hdwy	3.518	3.318	2.218	-	-	-
Pot Cap-1 Maneuver	180	397	825	-	-	-
Stage 1	453	-	-	-	-	-
Stage 2	601	-	-	-	-	-
Platoon blocked, %				-	-	-
Mov Cap-1 Maneuver	171	397	825	-	-	-
Mov Cap-2 Maneuver	303	-	-	-	-	-
Stage 1	429	-	-	-	-	-
Stage 2	601	-	-	-	-	-

Approach	EB	NB	SB
HCM Control Delay, s	17.2	0.9	0
HCM LOS	C		

Minor Lane/Major Mvmt	NBL	NBT	EBLn1	SBT	SBR
Capacity (veh/h)	825	-	347	-	-
HCM Lane V/C Ratio	0.053	-	0.147	-	-
HCM Control Delay (s)	9.6	-	17.2	-	-
HCM Lane LOS	A	-	C	-	-
HCM 95th %tile Q(veh)	0.2	-	0.5	-	-

Intersection	
Intersection Delay, s/veh	33.7
Intersection LOS	D

Movement	EBL	EBT	EBR	WBL	WBT	WBR	NBL	NBT	NBR	SBL	SBT	SBR
Lane Configurations		↕↔			↕	↕	↕	↕	↕	↕	↕	↕
Traffic Vol, veh/h	10	35	15	40	15	194	20	239	75	428	308	15
Future Vol, veh/h	10	35	15	40	15	194	20	239	75	428	308	15
Peak Hour Factor	0.92	0.92	0.92	0.92	0.92	0.92	0.92	0.92	0.92	0.92	0.92	0.92
Heavy Vehicles, %	2	2	2	2	2	2	2	2	2	2	2	2
Mvmt Flow	11	38	16	43	16	211	22	260	82	465	335	16
Number of Lanes	0	1	0	0	1	1	1	1	1	1	1	1

Approach	EB	WB	NB	SB
Opposing Approach	WB	EB	SB	NB
Opposing Lanes	2	1	3	3
Conflicting Approach Left	SB	NB	EB	WB
Conflicting Lanes Left	3	3	1	2
Conflicting Approach Right	NB	SB	WB	EB
Conflicting Lanes Right	3	3	2	1
HCM Control Delay	13.6	15.9	18.8	47.8
HCM LOS	B	C	C	E

Lane	NBLn1	NBLn2	NBLn3	EBLn1	WBLn1	WBLn2	SBLn1	SBLn2	SBLn3
Vol Left, %	100%	0%	0%	17%	73%	0%	100%	0%	0%
Vol Thru, %	0%	100%	0%	58%	27%	0%	0%	100%	0%
Vol Right, %	0%	0%	100%	25%	0%	100%	0%	0%	100%
Sign Control	Stop	Stop	Stop	Stop	Stop	Stop	Stop	Stop	Stop
Traffic Vol by Lane	20	239	75	60	55	194	428	308	15
LT Vol	20	0	0	10	40	0	428	0	0
Through Vol	0	239	0	35	15	0	0	308	0
RT Vol	0	0	75	15	0	194	0	0	15
Lane Flow Rate	22	260	82	65	60	211	465	335	16
Geometry Grp	8	8	8	8	8	8	8	8	8
Degree of Util (X)	0.052	0.582	0.166	0.163	0.146	0.452	0.99	0.665	0.029
Departure Headway (Hd)	8.582	8.069	7.35	9.017	8.788	7.71	7.662	7.151	6.435
Convergence, Y/N	Yes	Yes	Yes	Yes	Yes	Yes	Yes	Yes	Yes
Cap	417	447	487	397	408	466	475	506	555
Service Time	6.349	5.835	5.116	6.802	6.554	5.475	5.421	4.909	4.193
HCM Lane V/C Ratio	0.053	0.582	0.168	0.164	0.147	0.453	0.979	0.662	0.029
HCM Control Delay	11.8	21.6	11.6	13.6	13.1	16.7	66.9	23.1	9.4
HCM Lane LOS	B	C	B	B	B	C	F	C	A
HCM 95th-tile Q	0.2	3.6	0.6	0.6	0.5	2.3	12.9	4.8	0.1

Intersection						
Int Delay, s/veh	4.1					
Movement	EBL	EBT	WBT	WBR	SBL	SBR
Lane Configurations		↶	↷		↶	↷
Traffic Vol, veh/h	35	38	35	0	0	40
Future Vol, veh/h	35	38	35	0	0	40
Conflicting Peds, #/hr	0	0	0	0	0	0
Sign Control	Free	Free	Free	Free	Stop	Stop
RT Channelized	-	None	-	None	-	None
Storage Length	-	-	-	-	0	-
Veh in Median Storage, #	-	0	0	-	0	-
Grade, %	-	0	0	-	0	-
Peak Hour Factor	78	78	78	78	78	78
Heavy Vehicles, %	2	2	2	2	2	2
Mvmt Flow	45	49	45	0	0	51

Major/Minor	Major1	Major2	Minor2		
Conflicting Flow All	45	0	-	0	184 45
Stage 1	-	-	-	-	45 -
Stage 2	-	-	-	-	139 -
Critical Hdwy	4.12	-	-	-	6.42 6.22
Critical Hdwy Stg 1	-	-	-	-	5.42 -
Critical Hdwy Stg 2	-	-	-	-	5.42 -
Follow-up Hdwy	2.218	-	-	-	3.518 3.318
Pot Cap-1 Maneuver	1563	-	-	-	805 1025
Stage 1	-	-	-	-	977 -
Stage 2	-	-	-	-	888 -
Platoon blocked, %		-	-	-	
Mov Cap-1 Maneuver	1563	-	-	-	781 1025
Mov Cap-2 Maneuver	-	-	-	-	781 -
Stage 1	-	-	-	-	948 -
Stage 2	-	-	-	-	888 -

Approach	EB	WB	SB
HCM Control Delay, s	3.5	0	8.7
HCM LOS			A

Minor Lane/Major Mvmt	EBL	EBT	WBT	WBR	SBLn1
Capacity (veh/h)	1563	-	-	-	1025
HCM Lane V/C Ratio	0.029	-	-	-	0.05
HCM Control Delay (s)	7.4	0	-	-	8.7
HCM Lane LOS	A	A	-	-	A
HCM 95th %tile Q(veh)	0.1	-	-	-	0.2

Intersection						
Int Delay, s/veh	3.6					
Movement	EBT	EBR	WBL	WBT	NBL	NBR
Lane Configurations						
Traffic Vol, veh/h	5	33	0	5	30	0
Future Vol, veh/h	5	33	0	5	30	0
Conflicting Peds, #/hr	0	0	0	0	0	0
Sign Control	Free	Free	Free	Free	Stop	Stop
RT Channelized	-	None	-	None	-	None
Storage Length	-	-	-	-	0	-
Veh in Median Storage, #	0	-	-	0	0	-
Grade, %	0	-	-	0	0	-
Peak Hour Factor	92	92	92	92	92	92
Heavy Vehicles, %	2	2	2	2	2	2
Mvmt Flow	5	36	0	5	33	0

Major/Minor	Major1	Major2	Minor1		
Conflicting Flow All	0	0	41	0	28 23
Stage 1	-	-	-	-	23 -
Stage 2	-	-	-	-	5 -
Critical Hdwy	-	-	4.12	-	6.42 6.22
Critical Hdwy Stg 1	-	-	-	-	5.42 -
Critical Hdwy Stg 2	-	-	-	-	5.42 -
Follow-up Hdwy	-	-	2.218	-	3.518 3.318
Pot Cap-1 Maneuver	-	-	1568	-	987 1054
Stage 1	-	-	-	-	1000 -
Stage 2	-	-	-	-	1018 -
Platoon blocked, %	-	-	-	-	-
Mov Cap-1 Maneuver	-	-	1568	-	987 1054
Mov Cap-2 Maneuver	-	-	-	-	987 -
Stage 1	-	-	-	-	1000 -
Stage 2	-	-	-	-	1018 -

Approach	EB	WB	NB
HCM Control Delay, s	0	0	8.8
HCM LOS			A

Minor Lane/Major Mvmt	NBLn1	EBT	EBR	WBL	WBT
Capacity (veh/h)	987	-	-	1568	-
HCM Lane V/C Ratio	0.033	-	-	-	-
HCM Control Delay (s)	8.8	-	-	0	-
HCM Lane LOS	A	-	-	A	-
HCM 95th %tile Q(veh)	0.1	-	-	0	-

Phone: Fax:
E-Mail:

-----Directional Two-Lane Highway Segment Analysis-----

Analyst kda
Agency/Co.
Date Performed 3/9/2020
Analysis Time Period PM Peak
Highway SR 49
From/To Auburn to Sr 193
Jurisdiction Caltrans
Analysis Year 2019
Description Cool Dollar General

-----Input Data-----

Highway class	Class 1		Peak hour factor, PHF	0.92	
Shoulder width	2.0	ft	% Trucks and buses	6	%
Lane width	12.0	ft	% Trucks crawling	0.0	%
Segment length	8.0	mi	Truck crawl speed	0.0	mi/hr
Terrain type	Rolling		% Recreational vehicles	4	%
Grade: Length	-	mi	% No-passing zones	100	%
Up/down	-	%	Access point density	8	/mi

Analysis direction volume, Vd 257 veh/h
Opposing direction volume, Vo 561 veh/h

-----Average Travel Speed-----

Direction	Analysis(d)	Opposing (o)
PCE for trucks, ET	2.1	1.7
PCE for RVs, ER	1.1	1.1
Heavy-vehicle adj. factor,(note-5) fHV	0.935	0.956
Grade adj. factor,(note-1) fg	0.81	0.97
Directional flow rate,(note-2) vi	369 pc/h	658 pc/h

Free-Flow Speed from Field Measurement:

Field measured speed,(note-3) S FM	-	mi/h
Observed total demand,(note-3) V	-	veh/h
Estimated Free-Flow Speed:		
Base free-flow speed,(note-3) BFFS	55.0	mi/h
Adj. for lane and shoulder width,(note-3) fLS	2.6	mi/h
Adj. for access point density,(note-3) fA	2.0	mi/h
Free-flow speed, FFSd	50.4	mi/h
Adjustment for no-passing zones, fnp	1.7	mi/h
Average travel speed, ATSD	40.7	mi/h
Percent Free Flow Speed, PFFS	80.8	%

-----Percent Time-Spent-Following-----

Direction	Analysis(d)	Opposing (o)	
PCE for trucks, ET	1.7	1.0	
PCE for RVs, ER	1.0	1.0	
Heavy-vehicle adjustment factor, fHV	0.960	1.000	
Grade adjustment factor,(note-1) fg	0.84	0.97	
Directional flow rate,(note-2) vi	347 pc/h	629 pc/h	
Base percent time-spent-following,(note-4) BPTSFD	42.4	%	
Adjustment for no-passing zones, fnp	32.4		
Percent time-spent-following, PTSFD	53.9	%	

-----Level of Service and Other Performance Measures-----

Level of service, LOS	D	
Volume to capacity ratio, v/c	0.22	
Peak 15-min vehicle-miles of travel, VMT15	559	veh-mi
Peak-hour vehicle-miles of travel, VMT60	2056	veh-mi
Peak 15-min total travel time, TT15	13.7	veh-h
Capacity from ATS, CdATS	1576	veh/h
Capacity from PTSF, CdPTSF	1666	veh/h
Directional Capacity	1576	veh/h

-----Passing Lane Analysis-----

Total length of analysis segment, Lt	8.0	mi
Length of two-lane highway upstream of the passing lane, Lu	-	mi
Length of passing lane including tapers, Lpl	-	mi
Average travel speed, ATSD (from above)	40.7	mi/h
Percent time-spent-following, PTSFD (from above)	53.9	
Level of service, LOSd (from above)	D	

-----Average Travel Speed with Passing Lane-----

Downstream length of two-lane highway within effective length of passing lane for average travel speed, Lde	-	mi
Length of two-lane highway downstream of effective length of the passing lane for average travel speed, Ld	-	mi
Adj. factor for the effect of passing lane on average speed, fpl	-	
Average travel speed including passing lane, ATSp1	-	
Percent free flow speed including passing lane, PFFSp1	0.0	%

-----Percent Time-Spent-Following with Passing Lane-----

Downstream length of two-lane highway within effective length of passing lane for percent time-spent-following, Lde	-	mi
Length of two-lane highway downstream of effective length of the passing lane for percent time-spent-following, Ld	-	mi
Adj. factor for the effect of passing lane on percent time-spent-following, fpl	-	
Percent time-spent-following including passing lane, PTSFpl	-	%

-----Level of Service and Other Performance Measures with Passing Lane-----

Level of service including passing lane, LOSpl	E	
Peak 15-min total travel time, TT15	-	veh-h

-----Bicycle Level of Service-----

Posted speed limit, Sp	55
Percent of segment with occupied on-highway parking	0
Pavement rating, P	3
Flow rate in outside lane, vOL	279.3
Effective width of outside lane, We	14.00
Effective speed factor, St	4.79
Bicycle LOS Score, BLOS	5.24
Bicycle LOS	E

Notes:

1. Note that the adjustment factor for level terrain is 1.00, as level terrain is one of the base conditions. For the purpose of grade adjustment, specific downgrade segments are treated as level terrain.
2. If v_i (v_d or v_o) $\geq 1,700$ pc/h, terminate analysis-the LOS is F.
3. For the analysis direction only and for $v > 200$ veh/h.
4. For the analysis direction only.
5. Use alternative Exhibit 15-14 if some trucks operate at crawl speeds on a specific downgrade.

Phone: Fax:
E-Mail:

-----Directional Two-Lane Highway Segment Analysis-----

Analyst kda
Agency/Co.
Date Performed 3/9/2020
Analysis Time Period PM Peak
Highway SR 49
From/To Auburn to Sr 193
Jurisdiction Caltrans
Analysis Year 2019
Description Cool Dollar General

-----Input Data-----

Highway class	Class 1		Peak hour factor, PHF	0.92	
Shoulder width	2.0	ft	% Trucks and buses	6	%
Lane width	12.0	ft	% Trucks crawling	0.0	%
Segment length	8.0	mi	Truck crawl speed	0.0	mi/hr
Terrain type	Rolling		% Recreational vehicles	4	%
Grade: Length	-	mi	% No-passing zones	100	%
Up/down	-	%	Access point density	8	/mi

Analysis direction volume, Vd 561 veh/h
Opposing direction volume, Vo 257 veh/h

-----Average Travel Speed-----

Direction	Analysis(d)	Opposing (o)
PCE for trucks, ET	1.7	2.1
PCE for RVs, ER	1.1	1.1
Heavy-vehicle adj. factor,(note-5) fHV	0.956	0.935
Grade adj. factor,(note-1) fg	0.97	0.81
Directional flow rate,(note-2) vi	658 pc/h	369 pc/h

Free-Flow Speed from Field Measurement:

Field measured speed,(note-3) S FM - mi/h
Observed total demand,(note-3) V - veh/h

Estimated Free-Flow Speed:

Base free-flow speed,(note-3) BFfS 55.0 mi/h
Adj. for lane and shoulder width,(note-3) fLS 2.6 mi/h
Adj. for access point density,(note-3) fA 2.0 mi/h

Free-flow speed, FFfSd 50.4 mi/h

Adjustment for no-passing zones, fnp 2.9 mi/h
Average travel speed, ATfSd 39.5 mi/h
Percent Free Flow Speed, PFfS 78.4 %

-----Percent Time-Spent-Following-----

Direction	Analysis(d)	Opposing (o)	
PCE for trucks, ET	1.0	1.7	
PCE for RVs, ER	1.0	1.0	
Heavy-vehicle adjustment factor, fHV	1.000	0.960	
Grade adjustment factor,(note-1) fg	0.97	0.84	
Directional flow rate,(note-2) vi	629 pc/h	347 pc/h	
Base percent time-spent-following,(note-4) BPTSFD	56.5	%	
Adjustment for no-passing zones, fnp	32.4		
Percent time-spent-following, PTSFD	77.4	%	

-----Level of Service and Other Performance Measures-----

Level of service, LOS	E	
Volume to capacity ratio, v/c	0.39	
Peak 15-min vehicle-miles of travel, VMT15	1220	veh-mi
Peak-hour vehicle-miles of travel, VMT60	4488	veh-mi
Peak 15-min total travel time, TT15	30.9	veh-h
Capacity from ATS, CdATS	1367	veh/h
Capacity from PTSF, CdPTSF	1428	veh/h
Directional Capacity	1367	veh/h

-----Passing Lane Analysis-----

Total length of analysis segment, Lt	8.0	mi
Length of two-lane highway upstream of the passing lane, Lu	-	mi
Length of passing lane including tapers, Lpl	-	mi
Average travel speed, ATSD (from above)	39.5	mi/h
Percent time-spent-following, PTSFD (from above)	77.4	
Level of service, LOSd (from above)	E	

-----Average Travel Speed with Passing Lane-----

Downstream length of two-lane highway within effective length of passing lane for average travel speed, Lde	-	mi
Length of two-lane highway downstream of effective length of the passing lane for average travel speed, Ld	-	mi
Adj. factor for the effect of passing lane on average speed, fpl	-	
Average travel speed including passing lane, ATSp1	-	
Percent free flow speed including passing lane, PFFSp1	0.0	%

-----Percent Time-Spent-Following with Passing Lane-----

Downstream length of two-lane highway within effective length of passing lane for percent time-spent-following, Lde	-	mi
Length of two-lane highway downstream of effective length of the passing lane for percent time-spent-following, Ld	-	mi
Adj. factor for the effect of passing lane on percent time-spent-following, fpl	-	
Percent time-spent-following including passing lane, PTSFpl	-	%

-----Level of Service and Other Performance Measures with Passing Lane-----

Level of service including passing lane, LOSpl	E	
Peak 15-min total travel time, TT15	-	veh-h

-----Bicycle Level of Service-----

Posted speed limit, Sp	55
Percent of segment with occupied on-highway parking	0
Pavement rating, P	3
Flow rate in outside lane, vOL	609.8
Effective width of outside lane, We	14.00
Effective speed factor, St	4.79
Bicycle LOS Score, BLOS	5.64
Bicycle LOS	F

Notes:

1. Note that the adjustment factor for level terrain is 1.00, as level terrain is one of the base conditions. For the purpose of grade adjustment, specific downgrade segments are treated as level terrain.
2. If v_i (v_d or v_o) $\geq 1,700$ pc/h, terminate analysis-the LOS is F.
3. For the analysis direction only and for $v > 200$ veh/h.
4. For the analysis direction only.
5. Use alternative Exhibit 15-14 if some trucks operate at crawl speeds on a specific downgrade.

Phone: Fax:
E-Mail:

-----Directional Two-Lane Highway Segment Analysis-----

Analyst kda
Agency/Co.
Date Performed 3/9/2020
Analysis Time Period PM Peak
Highway SR 49
From/To SR 193 TO COLOMA
Jurisdiction Caltrans
Analysis Year 2019
Description Cool Dollar General

-----Input Data-----

Highway class	Class 1		Peak hour factor, PHF	0.92	
Shoulder width	2.0	ft	% Trucks and buses	6	%
Lane width	12.0	ft	% Trucks crawling	0.0	%
Segment length	8.0	mi	Truck crawl speed	0.0	mi/hr
Terrain type	Rolling		% Recreational vehicles	4	%
Grade: Length	-	mi	% No-passing zones	100	%
Up/down	-	%	Access point density	8	/mi

Analysis direction volume, Vd 213 veh/h
Opposing direction volume, Vo 256 veh/h

-----Average Travel Speed-----

Direction	Analysis(d)	Opposing (o)
PCE for trucks, ET	2.2	2.1
PCE for RVs, ER	1.1	1.1
Heavy-vehicle adj. factor,(note-5) fHV	0.929	0.935
Grade adj. factor,(note-1) fg	0.78	0.81
Directional flow rate,(note-2) vi	320 pc/h	367 pc/h

Free-Flow Speed from Field Measurement:

Field measured speed,(note-3) S FM	-	mi/h
Observed total demand,(note-3) V	-	veh/h
Estimated Free-Flow Speed:		
Base free-flow speed,(note-3) BFFS	55.0	mi/h
Adj. for lane and shoulder width,(note-3) fLS	2.6	mi/h
Adj. for access point density,(note-3) fA	2.0	mi/h
Free-flow speed, FFSd	50.4	mi/h
Adjustment for no-passing zones, fnp	2.9	mi/h
Average travel speed, ATSD	42.1	mi/h
Percent Free Flow Speed, PFFS	83.6	%

-----Percent Time-Spent-Following-----

Direction	Analysis(d)	Opposing (o)	
PCE for trucks, ET	1.7	1.7	
PCE for RVs, ER	1.0	1.0	
Heavy-vehicle adjustment factor, fHV	0.960	0.960	
Grade adjustment factor,(note-1) fg	0.82	0.84	
Directional flow rate,(note-2) vi	294 pc/h	345 pc/h	
Base percent time-spent-following,(note-4) BPTSFD	33.7	%	
Adjustment for no-passing zones, fnp	53.5		
Percent time-spent-following, PTSFD	58.3	%	

-----Level of Service and Other Performance Measures-----

Level of service, LOS	D	
Volume to capacity ratio, v/c	0.19	
Peak 15-min vehicle-miles of travel, VMT15	463	veh-mi
Peak-hour vehicle-miles of travel, VMT60	1704	veh-mi
Peak 15-min total travel time, TT15	11.0	veh-h
Capacity from ATS, CdATS	1367	veh/h
Capacity from PTSF, CdPTSF	1428	veh/h
Directional Capacity	1367	veh/h

-----Passing Lane Analysis-----

Total length of analysis segment, Lt	8.0	mi
Length of two-lane highway upstream of the passing lane, Lu	-	mi
Length of passing lane including tapers, Lpl	-	mi
Average travel speed, ATSD (from above)	42.1	mi/h
Percent time-spent-following, PTSFD (from above)	58.3	
Level of service, LOSd (from above)	D	

-----Average Travel Speed with Passing Lane-----

Downstream length of two-lane highway within effective length of passing lane for average travel speed, Lde	-	mi
Length of two-lane highway downstream of effective length of the passing lane for average travel speed, Ld	-	mi
Adj. factor for the effect of passing lane on average speed, fpl	-	
Average travel speed including passing lane, ATSp1	-	
Percent free flow speed including passing lane, PFFSp1	0.0	%

-----Percent Time-Spent-Following with Passing Lane-----

Downstream length of two-lane highway within effective length of passing lane for percent time-spent-following, Lde	-	mi
Length of two-lane highway downstream of effective length of the passing lane for percent time-spent-following, Ld	-	mi
Adj. factor for the effect of passing lane on percent time-spent-following, fpl	-	
Percent time-spent-following including passing lane, PTSFpl	-	%

-----Level of Service and Other Performance Measures with Passing Lane-----

Level of service including passing lane, LOSpl	E	
Peak 15-min total travel time, TT15	-	veh-h

-----Bicycle Level of Service-----

Posted speed limit, Sp	55
Percent of segment with occupied on-highway parking	0
Pavement rating, P	3
Flow rate in outside lane, vOL	231.5
Effective width of outside lane, We	14.00
Effective speed factor, St	4.79
Bicycle LOS Score, BLOS	5.15
Bicycle LOS	E

Notes:

1. Note that the adjustment factor for level terrain is 1.00, as level terrain is one of the base conditions. For the purpose of grade adjustment, specific downgrade segments are treated as level terrain.
2. If v_i (v_d or v_o) $\geq 1,700$ pc/h, terminate analysis-the LOS is F.
3. For the analysis direction only and for $v > 200$ veh/h.
4. For the analysis direction only.
5. Use alternative Exhibit 15-14 if some trucks operate at crawl speeds on a specific downgrade.

Phone: Fax:
 E-Mail:

-----Directional Two-Lane Highway Segment Analysis-----

Analyst kda
 Agency/Co.
 Date Performed 3/9/2020
 Analysis Time Period PM Peak
 Highway SR 49
 From/To SR 193 TO COLOMA
 Jurisdiction Caltrans
 Analysis Year 2019
 Description Cool Dollar General

-----Input Data-----

Highway class	Class 1	Peak hour factor, PHF	0.92
Shoulder width	2.0 ft	% Trucks and buses	6 %
Lane width	12.0 ft	% Trucks crawling	0.0 %
Segment length	8.0 mi	Truck crawl speed	0.0 mi/hr
Terrain type	Rolling	% Recreational vehicles	4 %
Grade: Length	- mi	% No-passing zones	100 %
Up/down	- %	Access point density	8 /mi

Analysis direction volume, Vd 256 veh/h
 Opposing direction volume, Vo 213 veh/h

-----Average Travel Speed-----

Direction	Analysis(d)	Opposing (o)
PCE for trucks, ET	2.1	2.2
PCE for RVs, ER	1.1	1.1
Heavy-vehicle adj. factor,(note-5) fHV	0.935	0.929
Grade adj. factor,(note-1) fg	0.81	0.78
Directional flow rate,(note-2) vi	367 pc/h	320 pc/h

Free-Flow Speed from Field Measurement:

Field measured speed,(note-3) S FM - mi/h
 Observed total demand,(note-3) V - veh/h

Estimated Free-Flow Speed:

Base free-flow speed,(note-3) BFfS 55.0 mi/h
 Adj. for lane and shoulder width,(note-3) fLS 2.6 mi/h
 Adj. for access point density,(note-3) fA 2.0 mi/h

Free-flow speed, FFfSd 50.4 mi/h

Adjustment for no-passing zones, fnp 3.2 mi/h
 Average travel speed, ATfSd 41.8 mi/h
 Percent Free Flow Speed, PFfS 83.0 %

-----Percent Time-Spent-Following-----

Direction	Analysis(d)	Opposing (o)	
PCE for trucks, ET	1.7	1.7	
PCE for RVs, ER	1.0	1.0	
Heavy-vehicle adjustment factor, fHV	0.960	0.960	
Grade adjustment factor,(note-1) fg	0.84	0.82	
Directional flow rate,(note-2) vi	345 pc/h	294 pc/h	
Base percent time-spent-following,(note-4) BPTSFD	36.9	%	
Adjustment for no-passing zones, fnp	53.5		
Percent time-spent-following, PTSFD	65.8	%	

-----Level of Service and Other Performance Measures-----

Level of service, LOS	D	
Volume to capacity ratio, v/c	0.22	
Peak 15-min vehicle-miles of travel, VMT15	557	veh-mi
Peak-hour vehicle-miles of travel, VMT60	2048	veh-mi
Peak 15-min total travel time, TT15	13.3	veh-h
Capacity from ATS, CdATS	1319	veh/h
Capacity from PTSF, CdPTSF	1387	veh/h
Directional Capacity	1319	veh/h

-----Passing Lane Analysis-----

Total length of analysis segment, Lt	8.0	mi
Length of two-lane highway upstream of the passing lane, Lu	-	mi
Length of passing lane including tapers, Lpl	-	mi
Average travel speed, ATSD (from above)	41.8	mi/h
Percent time-spent-following, PTSFD (from above)	65.8	
Level of service, LOSd (from above)	D	

-----Average Travel Speed with Passing Lane-----

Downstream length of two-lane highway within effective length of passing lane for average travel speed, Lde	-	mi
Length of two-lane highway downstream of effective length of the passing lane for average travel speed, Ld	-	mi
Adj. factor for the effect of passing lane on average speed, fpl	-	
Average travel speed including passing lane, ATSp1	-	
Percent free flow speed including passing lane, PFFSp1	0.0	%

-----Percent Time-Spent-Following with Passing Lane-----

Downstream length of two-lane highway within effective length of passing lane for percent time-spent-following, Lde	-	mi
Length of two-lane highway downstream of effective length of the passing lane for percent time-spent-following, Ld	-	mi
Adj. factor for the effect of passing lane on percent time-spent-following, fpl	-	
Percent time-spent-following including passing lane, PTSFpl	-	%

-----Level of Service and Other Performance Measures with Passing Lane-----

Level of service including passing lane, LOSpl	E	
Peak 15-min total travel time, TT15	-	veh-h

-----Bicycle Level of Service-----

Posted speed limit, Sp	55
Percent of segment with occupied on-highway parking	0
Pavement rating, P	3
Flow rate in outside lane, vOL	278.3
Effective width of outside lane, We	14.00
Effective speed factor, St	4.79
Bicycle LOS Score, BLOS	5.24
Bicycle LOS	E

Notes:

1. Note that the adjustment factor for level terrain is 1.00, as level terrain is one of the base conditions. For the purpose of grade adjustment, specific downgrade segments are treated as level terrain.
2. If v_i (v_d or v_o) $\geq 1,700$ pc/h, terminate analysis-the LOS is F.
3. For the analysis direction only and for $v > 200$ veh/h.
4. For the analysis direction only.
5. Use alternative Exhibit 15-14 if some trucks operate at crawl speeds on a specific downgrade.

Phone: Fax:
 E-Mail:

-----Directional Two-Lane Highway Segment Analysis-----

Analyst kda
 Agency/Co.
 Date Performed 3/9/2020
 Analysis Time Period PM Peak
 Highway SR 193
 From/To SR 49 TO GEORGETOWN
 Jurisdiction Caltrans
 Analysis Year 2019
 Description Cool Dollar General

-----Input Data-----

Highway class	Class 1	Peak hour factor, PHF	0.92	
Shoulder width	2.0 ft	% Trucks and buses	6	%
Lane width	12.0 ft	% Trucks crawling	0.0	%
Segment length	8.0 mi	Truck crawl speed	0.0	mi/hr
Terrain type	Rolling	% Recreational vehicles	4	%
Grade: Length	- mi	% No-passing zones	100	%
Up/down	- %	Access point density	8	/mi

Analysis direction volume, Vd 467 veh/h
 Opposing direction volume, Vo 200 veh/h

-----Average Travel Speed-----

Direction	Analysis(d)	Opposing (o)
PCE for trucks, ET	1.8	2.3
PCE for RVs, ER	1.1	1.1
Heavy-vehicle adj. factor,(note-5) fHV	0.951	0.924
Grade adj. factor,(note-1) fg	0.95	0.76
Directional flow rate,(note-2) vi	562 pc/h	310 pc/h

Free-Flow Speed from Field Measurement:

Field measured speed,(note-3) S FM - mi/h
 Observed total demand,(note-3) V - veh/h

Estimated Free-Flow Speed:

Base free-flow speed,(note-3) BFfS 55.0 mi/h
 Adj. for lane and shoulder width,(note-3) fLS 2.6 mi/h
 Adj. for access point density,(note-3) fA 2.0 mi/h

Free-flow speed, FFfSd 50.4 mi/h

Adjustment for no-passing zones, fnp 3.3 mi/h
 Average travel speed, ATfSd 40.3 mi/h
 Percent Free Flow Speed, PFFS 80.0 %

-----Percent Time-Spent-Following-----

Direction	Analysis(d)	Opposing (o)	
PCE for trucks, ET	1.2	1.7	
PCE for RVs, ER	1.0	1.0	
Heavy-vehicle adjustment factor, fHV	0.988	0.960	
Grade adjustment factor,(note-1) fg	0.96	0.81	
Directional flow rate,(note-2) vi	535 pc/h	280 pc/h	
Base percent time-spent-following,(note-4) BPTSFD	49.2	%	
Adjustment for no-passing zones, fnp	35.2		
Percent time-spent-following, PTSFD	72.3	%	

-----Level of Service and Other Performance Measures-----

Level of service, LOS	D	
Volume to capacity ratio, v/c	0.33	
Peak 15-min vehicle-miles of travel, VMT15	1015	veh-mi
Peak-hour vehicle-miles of travel, VMT60	3736	veh-mi
Peak 15-min total travel time, TT15	25.2	veh-h
Capacity from ATS, CdATS	1287	veh/h
Capacity from PTSF, CdPTSF	1370	veh/h
Directional Capacity	1287	veh/h

-----Passing Lane Analysis-----

Total length of analysis segment, Lt	8.0	mi
Length of two-lane highway upstream of the passing lane, Lu	-	mi
Length of passing lane including tapers, Lpl	-	mi
Average travel speed, ATSD (from above)	40.3	mi/h
Percent time-spent-following, PTSFD (from above)	72.3	
Level of service, LOSd (from above)	D	

-----Average Travel Speed with Passing Lane-----

Downstream length of two-lane highway within effective length of passing lane for average travel speed, Lde	-	mi
Length of two-lane highway downstream of effective length of the passing lane for average travel speed, Ld	-	mi
Adj. factor for the effect of passing lane on average speed, fpl	-	
Average travel speed including passing lane, ATSp1	-	
Percent free flow speed including passing lane, PFFSp1	0.0	%

-----Percent Time-Spent-Following with Passing Lane-----

Downstream length of two-lane highway within effective length of passing lane for percent time-spent-following, Lde	-	mi
Length of two-lane highway downstream of effective length of the passing lane for percent time-spent-following, Ld	-	mi
Adj. factor for the effect of passing lane on percent time-spent-following, fpl	-	
Percent time-spent-following including passing lane, PTSFpl	-	%

-----Level of Service and Other Performance Measures with Passing Lane-----

Level of service including passing lane, LOSpl	E	
Peak 15-min total travel time, TT15	-	veh-h

-----Bicycle Level of Service-----

Posted speed limit, Sp	55
Percent of segment with occupied on-highway parking	0
Pavement rating, P	3
Flow rate in outside lane, vOL	507.6
Effective width of outside lane, We	14.00
Effective speed factor, St	4.79
Bicycle LOS Score, BLOS	5.54
Bicycle LOS	F

Notes:

1. Note that the adjustment factor for level terrain is 1.00, as level terrain is one of the base conditions. For the purpose of grade adjustment, specific downgrade segments are treated as level terrain.
2. If v_i (v_d or v_o) $\geq 1,700$ pc/h, terminate analysis-the LOS is F.
3. For the analysis direction only and for $v > 200$ veh/h.
4. For the analysis direction only.
5. Use alternative Exhibit 15-14 if some trucks operate at crawl speeds on a specific downgrade.

Phone: Fax:
E-Mail:

-----Directional Two-Lane Highway Segment Analysis-----

Analyst kda
Agency/Co.
Date Performed 3/9/2020
Analysis Time Period PM Peak
Highway SR 193
From/To SR 49 TO GEORGETOWN
Jurisdiction Caltrans
Analysis Year 2019
Description Cool Dollar General

-----Input Data-----

Highway class	Class 1	Peak hour factor, PHF	0.92	
Shoulder width	2.0 ft	% Trucks and buses	6	%
Lane width	12.0 ft	% Trucks crawling	0.0	%
Segment length	8.0 mi	Truck crawl speed	0.0	mi/hr
Terrain type	Rolling	% Recreational vehicles	4	%
Grade: Length	- mi	% No-passing zones	100	%
Up/down	- %	Access point density	8	/mi

Analysis direction volume, Vd 200 veh/h
Opposing direction volume, Vo 467 veh/h

-----Average Travel Speed-----

Direction	Analysis(d)	Opposing (o)
PCE for trucks, ET	2.3	1.8
PCE for RVs, ER	1.1	1.1
Heavy-vehicle adj. factor,(note-5) fHV	0.924	0.951
Grade adj. factor,(note-1) fg	0.76	0.95
Directional flow rate,(note-2) vi	310 pc/h	562 pc/h

Free-Flow Speed from Field Measurement:

Field measured speed,(note-3) S FM - mi/h
Observed total demand,(note-3) V - veh/h

Estimated Free-Flow Speed:

Base free-flow speed,(note-3) BFFS 55.0 mi/h
Adj. for lane and shoulder width,(note-3) fLS 2.6 mi/h
Adj. for access point density,(note-3) fA 2.0 mi/h

Free-flow speed, FFSd 50.4 mi/h

Adjustment for no-passing zones, fnp 2.1 mi/h
Average travel speed, ATSD 41.6 mi/h
Percent Free Flow Speed, PFFS 82.5 %

-----Percent Time-Spent-Following-----

Direction	Analysis(d)	Opposing (o)	
PCE for trucks, ET	1.7	1.2	
PCE for RVs, ER	1.0	1.0	
Heavy-vehicle adjustment factor, fHV	0.960	0.988	
Grade adjustment factor,(note-1) fg	0.81	0.96	
Directional flow rate,(note-2) vi	280	535	pc/h
Base percent time-spent-following,(note-4) BPTSFD	34.9	%	
Adjustment for no-passing zones, fnp	35.2		
Percent time-spent-following, PTSFD	47.0	%	

-----Level of Service and Other Performance Measures-----

Level of service, LOS	D	
Volume to capacity ratio, v/c	0.18	
Peak 15-min vehicle-miles of travel, VMT15	435	veh-mi
Peak-hour vehicle-miles of travel, VMT60	1600	veh-mi
Peak 15-min total travel time, TT15	10.5	veh-h
Capacity from ATS, CdATS	1552	veh/h
Capacity from PTSF, CdPTSF	1613	veh/h
Directional Capacity	1552	veh/h

-----Passing Lane Analysis-----

Total length of analysis segment, Lt	8.0	mi
Length of two-lane highway upstream of the passing lane, Lu	-	mi
Length of passing lane including tapers, Lpl	-	mi
Average travel speed, ATSD (from above)	41.6	mi/h
Percent time-spent-following, PTSFD (from above)	47.0	
Level of service, LOSd (from above)	D	

-----Average Travel Speed with Passing Lane-----

Downstream length of two-lane highway within effective length of passing lane for average travel speed, Lde	-	mi
Length of two-lane highway downstream of effective length of the passing lane for average travel speed, Ld	-	mi
Adj. factor for the effect of passing lane on average speed, fpl	-	
Average travel speed including passing lane, ATSp1	-	
Percent free flow speed including passing lane, PFFSp1	0.0	%

-----Percent Time-Spent-Following with Passing Lane-----

Downstream length of two-lane highway within effective length of passing lane for percent time-spent-following, Lde	-	mi
Length of two-lane highway downstream of effective length of the passing lane for percent time-spent-following, Ld	-	mi
Adj. factor for the effect of passing lane on percent time-spent-following, fpl	-	
Percent time-spent-following including passing lane, PTSFpl	-	%

-----Level of Service and Other Performance Measures with Passing Lane-----

Level of service including passing lane, LOSpl	E	
Peak 15-min total travel time, TT15	-	veh-h

-----Bicycle Level of Service-----

Posted speed limit, Sp	55
Percent of segment with occupied on-highway parking	0
Pavement rating, P	3
Flow rate in outside lane, vOL	217.4
Effective width of outside lane, We	14.00
Effective speed factor, St	4.79
Bicycle LOS Score, BLOS	5.11
Bicycle LOS	E

Notes:

1. Note that the adjustment factor for level terrain is 1.00, as level terrain is one of the base conditions. For the purpose of grade adjustment, specific downgrade segments are treated as level terrain.
2. If v_i (v_d or v_o) $\geq 1,700$ pc/h, terminate analysis-the LOS is F.
3. For the analysis direction only and for $v > 200$ veh/h.
4. For the analysis direction only.
5. Use alternative Exhibit 15-14 if some trucks operate at crawl speeds on a specific downgrade.

Phone: Fax:
 E-Mail:

-----Directional Two-Lane Highway Segment Analysis-----

Analyst kda
 Agency/Co.
 Date Performed 3/9/2020
 Analysis Time Period PM Peak
 Highway SR 49
 From/To Auburn to Sr 193
 Jurisdiction Caltrans
 Analysis Year 2019 plus DOLLAR GENERAL
 Description Cool Dollar General

-----Input Data-----

Highway class	Class 1		Peak hour factor, PHF	0.92	
Shoulder width	2.0	ft	% Trucks and buses	6	%
Lane width	12.0	ft	% Trucks crawling	0.0	%
Segment length	8.0	mi	Truck crawl speed	0.0	mi/hr
Terrain type	Rolling		% Recreational vehicles	4	%
Grade: Length	-	mi	% No-passing zones	100	%
Up/down	-	%	Access point density	8	/mi

Analysis direction volume, Vd 259 veh/h
 Opposing direction volume, Vo 563 veh/h

-----Average Travel Speed-----

Direction	Analysis(d)	Opposing (o)
PCE for trucks, ET	2.1	1.7
PCE for RVs, ER	1.1	1.1
Heavy-vehicle adj. factor,(note-5) fHV	0.935	0.956
Grade adj. factor,(note-1) fg	0.82	0.97
Directional flow rate,(note-2) vi	367 pc/h	660 pc/h

Free-Flow Speed from Field Measurement:

Field measured speed,(note-3) S FM - mi/h
 Observed total demand,(note-3) V - veh/h

Estimated Free-Flow Speed:

Base free-flow speed,(note-3) BFfS 55.0 mi/h
 Adj. for lane and shoulder width,(note-3) fLS 2.6 mi/h
 Adj. for access point density,(note-3) fA 2.0 mi/h

Free-flow speed, FFfSd 50.4 mi/h

Adjustment for no-passing zones, fnp 1.7 mi/h
 Average travel speed, ATfSd 40.7 mi/h
 Percent Free Flow Speed, PFfS 80.8 %

-----Percent Time-Spent-Following-----

Direction	Analysis(d)	Opposing (o)	
PCE for trucks, ET	1.7	1.0	
PCE for RVs, ER	1.0	1.0	
Heavy-vehicle adjustment factor, fHV	0.960	1.000	
Grade adjustment factor,(note-1) fg	0.84	0.97	
Directional flow rate,(note-2) vi	349 pc/h	631 pc/h	
Base percent time-spent-following,(note-4) BPTSFD	42.4	%	
Adjustment for no-passing zones, fnp	32.4		
Percent time-spent-following, PTSFD	53.9	%	

-----Level of Service and Other Performance Measures-----

Level of service, LOS	D	
Volume to capacity ratio, v/c	0.22	
Peak 15-min vehicle-miles of travel, VMT15	563	veh-mi
Peak-hour vehicle-miles of travel, VMT60	2072	veh-mi
Peak 15-min total travel time, TT15	13.8	veh-h
Capacity from ATS, CdATS	1576	veh/h
Capacity from PTSF, CdPTSF	1666	veh/h
Directional Capacity	1576	veh/h

-----Passing Lane Analysis-----

Total length of analysis segment, Lt	8.0	mi
Length of two-lane highway upstream of the passing lane, Lu	-	mi
Length of passing lane including tapers, Lpl	-	mi
Average travel speed, ATSD (from above)	40.7	mi/h
Percent time-spent-following, PTSFD (from above)	53.9	
Level of service, LOSd (from above)	D	

-----Average Travel Speed with Passing Lane-----

Downstream length of two-lane highway within effective length of passing lane for average travel speed, Lde	-	mi
Length of two-lane highway downstream of effective length of the passing lane for average travel speed, Ld	-	mi
Adj. factor for the effect of passing lane on average speed, fpl	-	
Average travel speed including passing lane, ATSp1	-	
Percent free flow speed including passing lane, PFFSp1	0.0	%

-----Percent Time-Spent-Following with Passing Lane-----

Downstream length of two-lane highway within effective length of passing lane for percent time-spent-following, Lde	-	mi
Length of two-lane highway downstream of effective length of the passing lane for percent time-spent-following, Ld	-	mi
Adj. factor for the effect of passing lane on percent time-spent-following, fpl	-	
Percent time-spent-following including passing lane, PTSFpl	-	%

-----Level of Service and Other Performance Measures with Passing Lane-----

Level of service including passing lane, LOSpl	E	
Peak 15-min total travel time, TT15	-	veh-h

-----Bicycle Level of Service-----

Posted speed limit, Sp	55
Percent of segment with occupied on-highway parking	0
Pavement rating, P	3
Flow rate in outside lane, vOL	281.5
Effective width of outside lane, We	14.00
Effective speed factor, St	4.79
Bicycle LOS Score, BLOS	5.25
Bicycle LOS	E

Notes:

1. Note that the adjustment factor for level terrain is 1.00, as level terrain is one of the base conditions. For the purpose of grade adjustment, specific downgrade segments are treated as level terrain.
2. If v_i (v_d or v_o) $\geq 1,700$ pc/h, terminate analysis-the LOS is F.
3. For the analysis direction only and for $v > 200$ veh/h.
4. For the analysis direction only.
5. Use alternative Exhibit 15-14 if some trucks operate at crawl speeds on a specific downgrade.

Phone: Fax:
E-Mail:

-----Directional Two-Lane Highway Segment Analysis-----

Analyst kda
Agency/Co.
Date Performed 3/9/2020
Analysis Time Period PM Peak
Highway SR 49
From/To Auburn to Sr 193
Jurisdiction Caltrans
Analysis Year 2019 plus DOLLAR GENERAL
Description Cool Dollar General

-----Input Data-----

Highway class	Class 1		Peak hour factor, PHF	0.92	
Shoulder width	2.0	ft	% Trucks and buses	6	%
Lane width	12.0	ft	% Trucks crawling	0.0	%
Segment length	8.0	mi	Truck crawl speed	0.0	mi/hr
Terrain type	Rolling		% Recreational vehicles	4	%
Grade: Length	-	mi	% No-passing zones	100	%
Up/down	-	%	Access point density	8	/mi

Analysis direction volume, Vd 563 veh/h
Opposing direction volume, Vo 259 veh/h

-----Average Travel Speed-----

Direction	Analysis(d)	Opposing (o)
PCE for trucks, ET	1.7	2.1
PCE for RVs, ER	1.1	1.1
Heavy-vehicle adj. factor,(note-5) fHV	0.956	0.935
Grade adj. factor,(note-1) fg	0.97	0.82
Directional flow rate,(note-2) vi	660 pc/h	367 pc/h

Free-Flow Speed from Field Measurement:

Field measured speed,(note-3) S FM - mi/h
Observed total demand,(note-3) V - veh/h

Estimated Free-Flow Speed:

Base free-flow speed,(note-3) BFFS 55.0 mi/h
Adj. for lane and shoulder width,(note-3) fLS 2.6 mi/h
Adj. for access point density,(note-3) fA 2.0 mi/h

Free-flow speed, FFSd 50.4 mi/h

Adjustment for no-passing zones, fnp 2.9 mi/h
Average travel speed, ATSD 39.5 mi/h
Percent Free Flow Speed, PFFS 78.4 %

-----Percent Time-Spent-Following-----

Direction	Analysis(d)	Opposing (o)	
PCE for trucks, ET	1.0	1.7	
PCE for RVs, ER	1.0	1.0	
Heavy-vehicle adjustment factor, fHV	1.000	0.960	
Grade adjustment factor,(note-1) fg	0.97	0.84	
Directional flow rate,(note-2) vi	631 pc/h	349 pc/h	
Base percent time-spent-following,(note-4) BPTSFD	56.6	%	
Adjustment for no-passing zones, fnp	32.4		
Percent time-spent-following, PTSFD	77.5	%	

-----Level of Service and Other Performance Measures-----

Level of service, LOS	E	
Volume to capacity ratio, v/c	0.39	
Peak 15-min vehicle-miles of travel, VMT15	1224	veh-mi
Peak-hour vehicle-miles of travel, VMT60	4504	veh-mi
Peak 15-min total travel time, TT15	31.0	veh-h
Capacity from ATS, CdATS	1367	veh/h
Capacity from PTSF, CdPTSF	1428	veh/h
Directional Capacity	1367	veh/h

-----Passing Lane Analysis-----

Total length of analysis segment, Lt	8.0	mi
Length of two-lane highway upstream of the passing lane, Lu	-	mi
Length of passing lane including tapers, Lpl	-	mi
Average travel speed, ATSD (from above)	39.5	mi/h
Percent time-spent-following, PTSFD (from above)	77.5	
Level of service, LOSd (from above)	E	

-----Average Travel Speed with Passing Lane-----

Downstream length of two-lane highway within effective length of passing lane for average travel speed, Lde	-	mi
Length of two-lane highway downstream of effective length of the passing lane for average travel speed, Ld	-	mi
Adj. factor for the effect of passing lane on average speed, fpl	-	
Average travel speed including passing lane, ATSp1	-	
Percent free flow speed including passing lane, PFFSp1	0.0	%

-----Percent Time-Spent-Following with Passing Lane-----

Downstream length of two-lane highway within effective length of passing lane for percent time-spent-following, Lde	-	mi
Length of two-lane highway downstream of effective length of the passing lane for percent time-spent-following, Ld	-	mi
Adj. factor for the effect of passing lane on percent time-spent-following, fpl	-	
Percent time-spent-following including passing lane, PTSFpl	-	%

-----Level of Service and Other Performance Measures with Passing Lane-----

Level of service including passing lane, LOSpl	E	
Peak 15-min total travel time, TT15	-	veh-h

-----Bicycle Level of Service-----

Posted speed limit, Sp	55
Percent of segment with occupied on-highway parking	0
Pavement rating, P	3
Flow rate in outside lane, vOL	612.0
Effective width of outside lane, We	14.00
Effective speed factor, St	4.79
Bicycle LOS Score, BLOS	5.64
Bicycle LOS	F

Notes:

1. Note that the adjustment factor for level terrain is 1.00, as level terrain is one of the base conditions. For the purpose of grade adjustment, specific downgrade segments are treated as level terrain.
2. If v_i (v_d or v_o) $\geq 1,700$ pc/h, terminate analysis-the LOS is F.
3. For the analysis direction only and for $v > 200$ veh/h.
4. For the analysis direction only.
5. Use alternative Exhibit 15-14 if some trucks operate at crawl speeds on a specific downgrade.

Phone: Fax:
 E-Mail:

-----Directional Two-Lane Highway Segment Analysis-----

Analyst kda
 Agency/Co.
 Date Performed 3/9/2020
 Analysis Time Period PM Peak
 Highway SR 49
 From/To SR 193 TO COLOMA
 Jurisdiction Caltrans
 Analysis Year 2019 PLUS DOLLAR GENERAL
 Description Cool Dollar General

-----Input Data-----

Highway class	Class 1	Peak hour factor, PHF	0.92	
Shoulder width	2.0 ft	% Trucks and buses	6	%
Lane width	12.0 ft	% Trucks crawling	0.0	%
Segment length	8.0 mi	Truck crawl speed	0.0	mi/hr
Terrain type	Rolling	% Recreational vehicles	4	%
Grade: Length	- mi	% No-passing zones	100	%
Up/down	- %	Access point density	8	/mi

Analysis direction volume, Vd 222 veh/h
 Opposing direction volume, Vo 264 veh/h

-----Average Travel Speed-----

Direction	Analysis(d)	Opposing (o)
PCE for trucks, ET	2.2	2.1
PCE for RVs, ER	1.1	1.1
Heavy-vehicle adj. factor,(note-5) fHV	0.929	0.935
Grade adj. factor,(note-1) fg	0.78	0.82
Directional flow rate,(note-2) vi	333 pc/h	374 pc/h

Free-Flow Speed from Field Measurement:

Field measured speed,(note-3) S FM	-	mi/h
Observed total demand,(note-3) V	-	veh/h
Estimated Free-Flow Speed:		
Base free-flow speed,(note-3) BFFS	55.0	mi/h
Adj. for lane and shoulder width,(note-3) fLS	2.6	mi/h
Adj. for access point density,(note-3) fA	2.0	mi/h
Free-flow speed, FFSd	50.4	mi/h
Adjustment for no-passing zones, fnp	2.9	mi/h
Average travel speed, ATSD	42.0	mi/h
Percent Free Flow Speed, PFFS	83.4	%

-----Percent Time-Spent-Following-----

Direction	Analysis(d)	Opposing (o)	
PCE for trucks, ET	1.7	1.7	
PCE for RVs, ER	1.0	1.0	
Heavy-vehicle adjustment factor, fHV	0.960	0.960	
Grade adjustment factor,(note-1) fg	0.82	0.84	
Directional flow rate,(note-2) vi	307	356	pc/h
Base percent time-spent-following,(note-4) BPTSFD	34.3	%	
Adjustment for no-passing zones, fnp	52.2		
Percent time-spent-following, PTSFD	58.5	%	

-----Level of Service and Other Performance Measures-----

Level of service, LOS	D	
Volume to capacity ratio, v/c	0.20	
Peak 15-min vehicle-miles of travel, VMT15	483	veh-mi
Peak-hour vehicle-miles of travel, VMT60	1776	veh-mi
Peak 15-min total travel time, TT15	11.5	veh-h
Capacity from ATS, CdATS	1390	veh/h
Capacity from PTSF, CdPTSF	1444	veh/h
Directional Capacity	1390	veh/h

-----Passing Lane Analysis-----

Total length of analysis segment, Lt	8.0	mi
Length of two-lane highway upstream of the passing lane, Lu	-	mi
Length of passing lane including tapers, Lpl	-	mi
Average travel speed, ATSD (from above)	42.0	mi/h
Percent time-spent-following, PTSFD (from above)	58.5	
Level of service, LOSd (from above)	D	

-----Average Travel Speed with Passing Lane-----

Downstream length of two-lane highway within effective length of passing lane for average travel speed, Lde	-	mi
Length of two-lane highway downstream of effective length of the passing lane for average travel speed, Ld	-	mi
Adj. factor for the effect of passing lane on average speed, fpl	-	
Average travel speed including passing lane, ATSp1	-	
Percent free flow speed including passing lane, PFFSp1	0.0	%

-----Percent Time-Spent-Following with Passing Lane-----

Downstream length of two-lane highway within effective length of passing lane for percent time-spent-following, Lde	-	mi
Length of two-lane highway downstream of effective length of the passing lane for percent time-spent-following, Ld	-	mi
Adj. factor for the effect of passing lane on percent time-spent-following, fpl	-	
Percent time-spent-following including passing lane, PTSFpl	-	%

-----Level of Service and Other Performance Measures with Passing Lane-----

Level of service including passing lane, LOSpl	E	
Peak 15-min total travel time, TT15	-	veh-h

-----Bicycle Level of Service-----

Posted speed limit, Sp	55
Percent of segment with occupied on-highway parking	0
Pavement rating, P	3
Flow rate in outside lane, vOL	241.3
Effective width of outside lane, We	14.00
Effective speed factor, St	4.79
Bicycle LOS Score, BLOS	5.17
Bicycle LOS	E

Notes:

1. Note that the adjustment factor for level terrain is 1.00, as level terrain is one of the base conditions. For the purpose of grade adjustment, specific downgrade segments are treated as level terrain.
2. If v_i (v_d or v_o) $\geq 1,700$ pc/h, terminate analysis-the LOS is F.
3. For the analysis direction only and for $v > 200$ veh/h.
4. For the analysis direction only.
5. Use alternative Exhibit 15-14 if some trucks operate at crawl speeds on a specific downgrade.

Phone: Fax:
E-Mail:

----- Directional Two-Lane Highway Segment Analysis -----

Analyst kda
Agency/Co.
Date Performed 3/9/2020
Analysis Time Period PM Peak
Highway SR 49
From/To SR 193 TO COLOMA
Jurisdiction Caltrans
Analysis Year 2019 PLUS DOLLAR GENERAL
Description Cool Dollar General

----- Input Data -----

Highway class	Class 1		Peak hour factor, PHF	0.92	
Shoulder width	2.0	ft	% Trucks and buses	6	%
Lane width	12.0	ft	% Trucks crawling	0.0	%
Segment length	8.0	mi	Truck crawl speed	0.0	mi/hr
Terrain type	Rolling		% Recreational vehicles	4	%
Grade: Length	-	mi	% No-passing zones	100	%
Up/down	-	%	Access point density	8	/mi

Analysis direction volume, Vd 264 veh/h
Opposing direction volume, Vo 222 veh/h

----- Average Travel Speed -----

Direction	Analysis(d)	Opposing (o)
PCE for trucks, ET	2.1	2.2
PCE for RVs, ER	1.1	1.1
Heavy-vehicle adj. factor, (note-5) fHV	0.935	0.929
Grade adj. factor, (note-1) fg	0.82	0.78
Directional flow rate, (note-2) vi	374 pc/h	333 pc/h

Free-Flow Speed from Field Measurement:

Field measured speed, (note-3) S FM - mi/h
Observed total demand, (note-3) V - veh/h

Estimated Free-Flow Speed:

Base free-flow speed, (note-3) BFfs 55.0 mi/h
Adj. for lane and shoulder width, (note-3) fLS 2.6 mi/h
Adj. for access point density, (note-3) fA 2.0 mi/h

Free-flow speed, FFsd 50.4 mi/h

Adjustment for no-passing zones, fnp 3.1 mi/h
Average travel speed, ATsd 41.8 mi/h
Percent Free Flow Speed, PFFS 82.9 %

-----Percent Time-Spent-Following-----

Direction	Analysis(d)	Opposing (o)	
PCE for trucks, ET	1.7	1.7	
PCE for RVs, ER	1.0	1.0	
Heavy-vehicle adjustment factor, fHV	0.960	0.960	
Grade adjustment factor,(note-1) fg	0.84	0.82	
Directional flow rate,(note-2) vi	356 pc/h	307 pc/h	
Base percent time-spent-following,(note-4) BPTSFD	37.3	%	
Adjustment for no-passing zones, fnp	52.2		
Percent time-spent-following, PTSFD	65.3	%	

-----Level of Service and Other Performance Measures-----

Level of service, LOS	D	
Volume to capacity ratio, v/c	0.22	
Peak 15-min vehicle-miles of travel, VMT15	574	veh-mi
Peak-hour vehicle-miles of travel, VMT60	2112	veh-mi
Peak 15-min total travel time, TT15	13.7	veh-h
Capacity from ATS, CdATS	1319	veh/h
Capacity from PTSF, CdPTSF	1395	veh/h
Directional Capacity	1319	veh/h

-----Passing Lane Analysis-----

Total length of analysis segment, Lt	8.0	mi
Length of two-lane highway upstream of the passing lane, Lu	-	mi
Length of passing lane including tapers, Lpl	-	mi
Average travel speed, ATSD (from above)	41.8	mi/h
Percent time-spent-following, PTSFD (from above)	65.3	
Level of service, LOSd (from above)	D	

-----Average Travel Speed with Passing Lane-----

Downstream length of two-lane highway within effective length of passing lane for average travel speed, Lde	-	mi
Length of two-lane highway downstream of effective length of the passing lane for average travel speed, Ld	-	mi
Adj. factor for the effect of passing lane on average speed, fpl	-	
Average travel speed including passing lane, ATSp1	-	
Percent free flow speed including passing lane, PFFSp1	0.0	%

-----Percent Time-Spent-Following with Passing Lane-----

Downstream length of two-lane highway within effective length of passing lane for percent time-spent-following, Lde	-	mi
Length of two-lane highway downstream of effective length of the passing lane for percent time-spent-following, Ld	-	mi
Adj. factor for the effect of passing lane on percent time-spent-following, fpl	-	
Percent time-spent-following including passing lane, PTSFpl	-	%

-----Level of Service and Other Performance Measures with Passing Lane-----

Level of service including passing lane, LOSpl	E	
Peak 15-min total travel time, TT15	-	veh-h

-----Bicycle Level of Service-----

Posted speed limit, Sp	55
Percent of segment with occupied on-highway parking	0
Pavement rating, P	3
Flow rate in outside lane, vOL	287.0
Effective width of outside lane, We	14.00
Effective speed factor, St	4.79
Bicycle LOS Score, BLOS	5.25
Bicycle LOS	E

Notes:

1. Note that the adjustment factor for level terrain is 1.00, as level terrain is one of the base conditions. For the purpose of grade adjustment, specific downgrade segments are treated as level terrain.
2. If v_i (v_d or v_o) $\geq 1,700$ pc/h, terminate analysis-the LOS is F.
3. For the analysis direction only and for $v > 200$ veh/h.
4. For the analysis direction only.
5. Use alternative Exhibit 15-14 if some trucks operate at crawl speeds on a specific downgrade.

Phone: Fax:
 E-Mail:

-----Directional Two-Lane Highway Segment Analysis-----

Analyst kda
 Agency/Co.
 Date Performed 3/9/2020
 Analysis Time Period PM Peak
 Highway SR 193
 From/To SR 49 TO GEORGETOWN
 Jurisdiction Caltrans
 Analysis Year 2019 PLUS DOLLAR GENEAL
 Description Cool Dollar General

-----Input Data-----

Highway class	Class 1	Peak hour factor, PHF	0.92	
Shoulder width	2.0 ft	% Trucks and buses	6	%
Lane width	12.0 ft	% Trucks crawling	0.0	%
Segment length	8.0 mi	Truck crawl speed	0.0	mi/hr
Terrain type	Rolling	% Recreational vehicles	4	%
Grade: Length	- mi	% No-passing zones	100	%
Up/down	- %	Access point density	8	/mi

Analysis direction volume, Vd 475 veh/h
 Opposing direction volume, Vo 209 veh/h

-----Average Travel Speed-----

Direction	Analysis(d)	Opposing (o)
PCE for trucks, ET	1.8	2.2
PCE for RVs, ER	1.1	1.1
Heavy-vehicle adj. factor,(note-5) fHV	0.951	0.929
Grade adj. factor,(note-1) fg	0.95	0.77
Directional flow rate,(note-2) vi	571 pc/h	318 pc/h

Free-Flow Speed from Field Measurement:

Field measured speed,(note-3) S FM	-	mi/h
Observed total demand,(note-3) V	-	veh/h
Estimated Free-Flow Speed:		
Base free-flow speed,(note-3) BFFS	55.0	mi/h
Adj. for lane and shoulder width,(note-3) fLS	2.6	mi/h
Adj. for access point density,(note-3) fA	2.0	mi/h
Free-flow speed, FFSd	50.4	mi/h
Adjustment for no-passing zones, fnp	3.2	mi/h
Average travel speed, ATSD	40.3	mi/h
Percent Free Flow Speed, PFFS	79.9	%

-----Percent Time-Spent-Following-----

Direction	Analysis(d)	Opposing (o)	
PCE for trucks, ET	1.2	1.7	
PCE for RVs, ER	1.0	1.0	
Heavy-vehicle adjustment factor, fHV	0.988	0.960	
Grade adjustment factor,(note-1) fg	0.96	0.81	
Directional flow rate,(note-2) vi	544 pc/h	292 pc/h	
Base percent time-spent-following,(note-4) BPTSFD	51.1 %		
Adjustment for no-passing zones, fnp	35.0		
Percent time-spent-following, PTSFD	73.9 %		

-----Level of Service and Other Performance Measures-----

Level of service, LOS	D	
Volume to capacity ratio, v/c	0.34	
Peak 15-min vehicle-miles of travel, VMT15	1033	veh-mi
Peak-hour vehicle-miles of travel, VMT60	3800	veh-mi
Peak 15-min total travel time, TT15	25.7	veh-h
Capacity from ATS, CdATS	1303	veh/h
Capacity from PTSF, CdPTSF	1387	veh/h
Directional Capacity	1303	veh/h

-----Passing Lane Analysis-----

Total length of analysis segment, Lt	8.0	mi
Length of two-lane highway upstream of the passing lane, Lu	-	mi
Length of passing lane including tapers, Lpl	-	mi
Average travel speed, ATSD (from above)	40.3	mi/h
Percent time-spent-following, PTSFD (from above)	73.9	
Level of service, LOSd (from above)	D	

-----Average Travel Speed with Passing Lane-----

Downstream length of two-lane highway within effective length of passing lane for average travel speed, Lde	-	mi
Length of two-lane highway downstream of effective length of the passing lane for average travel speed, Ld	-	mi
Adj. factor for the effect of passing lane on average speed, fpl	-	
Average travel speed including passing lane, ATSp1	-	
Percent free flow speed including passing lane, PFFSp1	0.0	%

-----Percent Time-Spent-Following with Passing Lane-----

Downstream length of two-lane highway within effective length of passing lane for percent time-spent-following, Lde	-	mi
Length of two-lane highway downstream of effective length of the passing lane for percent time-spent-following, Ld	-	mi
Adj. factor for the effect of passing lane on percent time-spent-following, fpl	-	
Percent time-spent-following including passing lane, PTSFpl	-	%

-----Level of Service and Other Performance Measures with Passing Lane-----

Level of service including passing lane, LOSpl	E	
Peak 15-min total travel time, TT15	-	veh-h

-----Bicycle Level of Service-----

Posted speed limit, Sp	55
Percent of segment with occupied on-highway parking	0
Pavement rating, P	3
Flow rate in outside lane, vOL	516.3
Effective width of outside lane, We	14.00
Effective speed factor, St	4.79
Bicycle LOS Score, BLOS	5.55
Bicycle LOS	F

Notes:

1. Note that the adjustment factor for level terrain is 1.00, as level terrain is one of the base conditions. For the purpose of grade adjustment, specific downgrade segments are treated as level terrain.
2. If v_i (v_d or v_o) $\geq 1,700$ pc/h, terminate analysis-the LOS is F.
3. For the analysis direction only and for $v > 200$ veh/h.
4. For the analysis direction only.
5. Use alternative Exhibit 15-14 if some trucks operate at crawl speeds on a specific downgrade.

Phone: Fax:
E-Mail:

-----Directional Two-Lane Highway Segment Analysis-----

Analyst kda
Agency/Co.
Date Performed 3/9/2020
Analysis Time Period PM Peak
Highway SR 193
From/To SR 49 TO GEORGETOWN
Jurisdiction Caltrans
Analysis Year 2019 PLUS DOLLAR GENEAL
Description Cool Dollar General

-----Input Data-----

Highway class	Class 1		Peak hour factor, PHF	0.92	
Shoulder width	2.0	ft	% Trucks and buses	6	%
Lane width	12.0	ft	% Trucks crawling	0.0	%
Segment length	8.0	mi	Truck crawl speed	0.0	mi/hr
Terrain type	Rolling		% Recreational vehicles	4	%
Grade: Length	-	mi	% No-passing zones	100	%
Up/down	-	%	Access point density	8	/mi

Analysis direction volume, Vd 209 veh/h
Opposing direction volume, Vo 475 veh/h

-----Average Travel Speed-----

Direction	Analysis(d)	Opposing (o)
PCE for trucks, ET	2.2	1.8
PCE for RVs, ER	1.1	1.1
Heavy-vehicle adj. factor,(note-5) fHV	0.929	0.951
Grade adj. factor,(note-1) fg	0.77	0.95
Directional flow rate,(note-2) vi	318 pc/h	571 pc/h

Free-Flow Speed from Field Measurement:

Field measured speed,(note-3) S FM - mi/h
Observed total demand,(note-3) V - veh/h

Estimated Free-Flow Speed:

Base free-flow speed,(note-3) BFFS 55.0 mi/h
Adj. for lane and shoulder width,(note-3) fLS 2.6 mi/h
Adj. for access point density,(note-3) fA 2.0 mi/h

Free-flow speed, FFSd 50.4 mi/h

Adjustment for no-passing zones, fnp 2.0 mi/h
Average travel speed, ATSD 41.5 mi/h
Percent Free Flow Speed, PFFS 82.3 %

-----Percent Time-Spent-Following-----

Direction	Analysis(d)	Opposing (o)	
PCE for trucks, ET	1.7	1.2	
PCE for RVs, ER	1.0	1.0	
Heavy-vehicle adjustment factor, fHV	0.960	0.988	
Grade adjustment factor,(note-1) fg	0.81	0.96	
Directional flow rate,(note-2) vi	292 pc/h	544 pc/h	
Base percent time-spent-following,(note-4) BPTSFD	36.6	%	
Adjustment for no-passing zones, fnp	35.0		
Percent time-spent-following, PTSFD	48.8	%	

-----Level of Service and Other Performance Measures-----

Level of service, LOS	D	
Volume to capacity ratio, v/c	0.19	
Peak 15-min vehicle-miles of travel, VMT15	454	veh-mi
Peak-hour vehicle-miles of travel, VMT60	1672	veh-mi
Peak 15-min total travel time, TT15	10.9	veh-h
Capacity from ATS, CdATS	1552	veh/h
Capacity from PTSF, CdPTSF	1613	veh/h
Directional Capacity	1552	veh/h

-----Passing Lane Analysis-----

Total length of analysis segment, Lt	8.0	mi
Length of two-lane highway upstream of the passing lane, Lu	-	mi
Length of passing lane including tapers, Lpl	-	mi
Average travel speed, ATSD (from above)	41.5	mi/h
Percent time-spent-following, PTSFD (from above)	48.8	
Level of service, LOSd (from above)	D	

-----Average Travel Speed with Passing Lane-----

Downstream length of two-lane highway within effective length of passing lane for average travel speed, Lde	-	mi
Length of two-lane highway downstream of effective length of the passing lane for average travel speed, Ld	-	mi
Adj. factor for the effect of passing lane on average speed, fpl	-	
Average travel speed including passing lane, ATSp1	-	
Percent free flow speed including passing lane, PFFSp1	0.0	%

-----Percent Time-Spent-Following with Passing Lane-----

Downstream length of two-lane highway within effective length of passing lane for percent time-spent-following, Lde	-	mi
Length of two-lane highway downstream of effective length of the passing lane for percent time-spent-following, Ld	-	mi
Adj. factor for the effect of passing lane on percent time-spent-following, fpl	-	
Percent time-spent-following including passing lane, PTSFpl	-	%

-----Level of Service and Other Performance Measures with Passing Lane-----

Level of service including passing lane, LOSpl	E	
Peak 15-min total travel time, TT15	-	veh-h

-----Bicycle Level of Service-----

Posted speed limit, Sp	55
Percent of segment with occupied on-highway parking	0
Pavement rating, P	3
Flow rate in outside lane, vOL	227.2
Effective width of outside lane, We	14.00
Effective speed factor, St	4.79
Bicycle LOS Score, BLOS	5.14
Bicycle LOS	E

Notes:

1. Note that the adjustment factor for level terrain is 1.00, as level terrain is one of the base conditions. For the purpose of grade adjustment, specific downgrade segments are treated as level terrain.
2. If v_i (v_d or v_o) $\geq 1,700$ pc/h, terminate analysis-the LOS is F.
3. For the analysis direction only and for $v > 200$ veh/h.
4. For the analysis direction only.
5. Use alternative Exhibit 15-14 if some trucks operate at crawl speeds on a specific downgrade.

Phone: Fax:
E-Mail:

-----Directional Two-Lane Highway Segment Analysis-----

Analyst kda
Agency/Co.
Date Performed 3/9/2020
Analysis Time Period PM Peak
Highway SR 49
From/To Auburn to SR 193
Jurisdiction Caltrans
Analysis Year 2040
Description Cool Dollar General

-----Input Data-----

Highway class	Class 1	Peak hour factor, PHF	0.92	
Shoulder width	2.0 ft	% Trucks and buses	6	%
Lane width	12.0 ft	% Trucks crawling	0.0	%
Segment length	8.0 mi	Truck crawl speed	0.0	mi/hr
Terrain type	Rolling	% Recreational vehicles	4	%
Grade: Length	- mi	% No-passing zones	100	%
Up/down	- %	Access point density	8	/mi

Analysis direction volume, Vd 425 veh/h
Opposing direction volume, Vo 735 veh/h

-----Average Travel Speed-----

Direction	Analysis(d)	Opposing (o)
PCE for trucks, ET	1.9	1.4
PCE for RVs, ER	1.1	1.1
Heavy-vehicle adj. factor,(note-5) fHV	0.945	0.973
Grade adj. factor,(note-1) fg	0.93	0.99
Directional flow rate,(note-2) vi	526 pc/h	829 pc/h

Free-Flow Speed from Field Measurement:

Field measured speed,(note-3) S FM - mi/h
Observed total demand,(note-3) V - veh/h

Estimated Free-Flow Speed:

Base free-flow speed,(note-3) BFfS 55.0 mi/h
Adj. for lane and shoulder width,(note-3) fLS 2.6 mi/h
Adj. for access point density,(note-3) fA 2.0 mi/h

Free-flow speed, FFfSd 50.4 mi/h

Adjustment for no-passing zones, fnp 1.3 mi/h
Average travel speed, ATfSd 38.6 mi/h
Percent Free Flow Speed, PFfS 76.6 %

-----Percent Time-Spent-Following-----

Direction	Analysis(d)	Opposing (o)	
PCE for trucks, ET	1.4	1.0	
PCE for RVs, ER	1.0	1.0	
Heavy-vehicle adjustment factor, fHV	0.977	1.000	
Grade adjustment factor,(note-1) fg	0.94	1.00	
Directional flow rate,(note-2) vi	503 pc/h	799 pc/h	
Base percent time-spent-following,(note-4) BPTSFD	55.1	%	
Adjustment for no-passing zones, fnp	27.9		
Percent time-spent-following, PTSFD	65.9	%	

-----Level of Service and Other Performance Measures-----

Level of service, LOS	E	
Volume to capacity ratio, v/c	0.31	
Peak 15-min vehicle-miles of travel, VMT15	924	veh-mi
Peak-hour vehicle-miles of travel, VMT60	3400	veh-mi
Peak 15-min total travel time, TT15	23.9	veh-h
Capacity from ATS, CdATS	1638	veh/h
Capacity from PTSF, CdPTSF	1700	veh/h
Directional Capacity	1638	veh/h

-----Passing Lane Analysis-----

Total length of analysis segment, Lt	8.0	mi
Length of two-lane highway upstream of the passing lane, Lu	-	mi
Length of passing lane including tapers, Lpl	-	mi
Average travel speed, ATSD (from above)	38.6	mi/h
Percent time-spent-following, PTSFD (from above)	65.9	
Level of service, LOSd (from above)	E	

-----Average Travel Speed with Passing Lane-----

Downstream length of two-lane highway within effective length of passing lane for average travel speed, Lde	-	mi
Length of two-lane highway downstream of effective length of the passing lane for average travel speed, Ld	-	mi
Adj. factor for the effect of passing lane on average speed, fpl	-	
Average travel speed including passing lane, ATSp1	-	
Percent free flow speed including passing lane, PFFSp1	0.0	%

-----Percent Time-Spent-Following with Passing Lane-----

Downstream length of two-lane highway within effective length of passing lane for percent time-spent-following, Lde	-	mi
Length of two-lane highway downstream of effective length of the passing lane for percent time-spent-following, Ld	-	mi
Adj. factor for the effect of passing lane on percent time-spent-following, fpl	-	
Percent time-spent-following including passing lane, PTSFpl	-	%

-----Level of Service and Other Performance Measures with Passing Lane-----

Level of service including passing lane, LOSpl	E	
Peak 15-min total travel time, TT15	-	veh-h

-----Bicycle Level of Service-----

Posted speed limit, Sp	55
Percent of segment with occupied on-highway parking	0
Pavement rating, P	3
Flow rate in outside lane, vOL	462.0
Effective width of outside lane, We	14.00
Effective speed factor, St	4.79
Bicycle LOS Score, BLOS	5.50
Bicycle LOS	E

Notes:

1. Note that the adjustment factor for level terrain is 1.00, as level terrain is one of the base conditions. For the purpose of grade adjustment, specific downgrade segments are treated as level terrain.
2. If v_i (v_d or v_o) $\geq 1,700$ pc/h, terminate analysis-the LOS is F.
3. For the analysis direction only and for $v > 200$ veh/h.
4. For the analysis direction only.
5. Use alternative Exhibit 15-14 if some trucks operate at crawl speeds on a specific downgrade.

Phone: Fax:
E-Mail:

-----Directional Two-Lane Highway Segment Analysis-----

Analyst kda
Agency/Co.
Date Performed 3/9/2020
Analysis Time Period PM Peak
Highway SR 49
From/To Auburn to Sr 193
Jurisdiction Caltrans
Analysis Year 2040
Description Cool Dollar General

-----Input Data-----

Highway class	Class 1		Peak hour factor, PHF	0.92	
Shoulder width	2.0	ft	% Trucks and buses	6	%
Lane width	12.0	ft	% Trucks crawling	0.0	%
Segment length	8.0	mi	Truck crawl speed	0.0	mi/hr
Terrain type	Rolling		% Recreational vehicles	4	%
Grade: Length	-	mi	% No-passing zones	100	%
Up/down	-	%	Access point density	8	/mi

Analysis direction volume, Vd 735 veh/h
Opposing direction volume, Vo 425 veh/h

-----Average Travel Speed-----

Direction	Analysis(d)	Opposing (o)
PCE for trucks, ET	1.4	1.9
PCE for RVs, ER	1.1	1.1
Heavy-vehicle adj. factor,(note-5) fHV	0.973	0.945
Grade adj. factor,(note-1) fg	0.99	0.93
Directional flow rate,(note-2) vi	829 pc/h	526 pc/h

Free-Flow Speed from Field Measurement:

Field measured speed,(note-3) S FM - mi/h
Observed total demand,(note-3) V - veh/h

Estimated Free-Flow Speed:

Base free-flow speed,(note-3) BFfs 55.0 mi/h
Adj. for lane and shoulder width,(note-3) fLS 2.6 mi/h
Adj. for access point density,(note-3) fA 2.0 mi/h

Free-flow speed, FFsd 50.4 mi/h

Adjustment for no-passing zones, fnp 2.2 mi/h
Average travel speed, ATsd 37.7 mi/h
Percent Free Flow Speed, PFFS 74.8 %

-----Percent Time-Spent-Following-----

Direction	Analysis(d)	Opposing (o)	
PCE for trucks, ET	1.0	1.4	
PCE for RVs, ER	1.0	1.0	
Heavy-vehicle adjustment factor, fHV	1.000	0.977	
Grade adjustment factor,(note-1) fg	1.00	0.94	
Directional flow rate,(note-2) vi	799 pc/h	503 pc/h	
Base percent time-spent-following,(note-4) BPTSFD	67.3	%	
Adjustment for no-passing zones, fnp	27.9		
Percent time-spent-following, PTSFD	84.4	%	

-----Level of Service and Other Performance Measures-----

Level of service, LOS	E	
Volume to capacity ratio, v/c	0.49	
Peak 15-min vehicle-miles of travel, VMT15	1598	veh-mi
Peak-hour vehicle-miles of travel, VMT60	5880	veh-mi
Peak 15-min total travel time, TT15	42.4	veh-h
Capacity from ATS, CdATS	1536	veh/h
Capacity from PTSF, CdPTSF	1613	veh/h
Directional Capacity	1536	veh/h

-----Passing Lane Analysis-----

Total length of analysis segment, Lt	8.0	mi
Length of two-lane highway upstream of the passing lane, Lu	-	mi
Length of passing lane including tapers, Lpl	-	mi
Average travel speed, ATSD (from above)	37.7	mi/h
Percent time-spent-following, PTSFD (from above)	84.4	
Level of service, LOSd (from above)	E	

-----Average Travel Speed with Passing Lane-----

Downstream length of two-lane highway within effective length of passing lane for average travel speed, Lde	-	mi
Length of two-lane highway downstream of effective length of the passing lane for average travel speed, Ld	-	mi
Adj. factor for the effect of passing lane on average speed, fpl	-	
Average travel speed including passing lane, ATSp1	-	
Percent free flow speed including passing lane, PFFSp1	0.0	%

-----Percent Time-Spent-Following with Passing Lane-----

Downstream length of two-lane highway within effective length of passing lane for percent time-spent-following, Lde	-	mi
Length of two-lane highway downstream of effective length of the passing lane for percent time-spent-following, Ld	-	mi
Adj. factor for the effect of passing lane on percent time-spent-following, fpl	-	
Percent time-spent-following including passing lane, PTSFpl	-	%

-----Level of Service and Other Performance Measures with Passing Lane-----

Level of service including passing lane, LOSpl	E	
Peak 15-min total travel time, TT15	-	veh-h

-----Bicycle Level of Service-----

Posted speed limit, Sp	55
Percent of segment with occupied on-highway parking	0
Pavement rating, P	3
Flow rate in outside lane, vOL	798.9
Effective width of outside lane, We	14.00
Effective speed factor, St	4.79
Bicycle LOS Score, BLOS	5.77
Bicycle LOS	F

Notes:

1. Note that the adjustment factor for level terrain is 1.00, as level terrain is one of the base conditions. For the purpose of grade adjustment, specific downgrade segments are treated as level terrain.
2. If v_i (v_d or v_o) $\geq 1,700$ pc/h, terminate analysis-the LOS is F.
3. For the analysis direction only and for $v > 200$ veh/h.
4. For the analysis direction only.
5. Use alternative Exhibit 15-14 if some trucks operate at crawl speeds on a specific downgrade.

Phone: Fax:
E-Mail:

-----Directional Two-Lane Highway Segment Analysis-----

Analyst kda
Agency/Co.
Date Performed 3/9/2020
Analysis Time Period PM Peak
Highway SR 49
From/To SR 193 TO COLOMA
Jurisdiction Caltrans
Analysis Year 2040
Description Cool Dollar General

-----Input Data-----

Highway class	Class 1	Peak hour factor, PHF	0.92	
Shoulder width	2.0 ft	% Trucks and buses	6	%
Lane width	12.0 ft	% Trucks crawling	0.0	%
Segment length	8.0 mi	Truck crawl speed	0.0	mi/hr
Terrain type	Specific Grade	% Recreational vehicles	4	%
Grade: Length	0.25 mi	% No-passing zones	100	%
Up/down	3.0 %	Access point density	8	/mi

Analysis direction volume, Vd 325 veh/h
Opposing direction volume, Vo 330 veh/h

-----Average Travel Speed-----

Direction	Analysis(d)	Opposing (o)
PCE for trucks, ET	2.2	1.3
PCE for RVs, ER	1.0	1.0
Heavy-vehicle adj. factor,(note-5) fHV	0.930	0.982
Grade adj. factor,(note-1) fg	0.89	1.00
Directional flow rate,(note-2) vi	427 pc/h	365 pc/h

Free-Flow Speed from Field Measurement:

Field measured speed,(note-3) S FM	-	mi/h
Observed total demand,(note-3) V	-	veh/h
Estimated Free-Flow Speed:		
Base free-flow speed,(note-3) BFFS	55.0	mi/h
Adj. for lane and shoulder width,(note-3) fLS	2.6	mi/h
Adj. for access point density,(note-3) fA	2.0	mi/h
Free-flow speed, FFSd	50.4	mi/h
Adjustment for no-passing zones, fnp	2.9	mi/h
Average travel speed, ATSD	41.3	mi/h
Percent Free Flow Speed, PFFS	82.0	%

-----Percent Time-Spent-Following-----

Direction	Analysis(d)	Opposing (o)	
PCE for trucks, ET	1.0	1.1	
PCE for RVs, ER	1.0	1.0	
Heavy-vehicle adjustment factor, fHV	1.000	0.994	
Grade adjustment factor,(note-1) fg	0.96	1.00	
Directional flow rate,(note-2) vi	366 pc/h	361 pc/h	
Base percent time-spent-following,(note-4) BPTSFD	38.9	%	
Adjustment for no-passing zones, fnp	50.2		
Percent time-spent-following, PTSFD	64.2	%	

-----Level of Service and Other Performance Measures-----

Level of service, LOS	D	
Volume to capacity ratio, v/c	0.25	
Peak 15-min vehicle-miles of travel, VMT15	707	veh-mi
Peak-hour vehicle-miles of travel, VMT60	2600	veh-mi
Peak 15-min total travel time, TT15	17.1	veh-h
Capacity from ATS, CdATS	1409	veh/h
Capacity from PTSF, CdPTSF	1639	veh/h
Directional Capacity	1409	veh/h

-----Passing Lane Analysis-----

Total length of analysis segment, Lt	8.0	mi
Length of two-lane highway upstream of the passing lane, Lu	-	mi
Length of passing lane including tapers, Lpl	-	mi
Average travel speed, ATSD (from above)	41.3	mi/h
Percent time-spent-following, PTSFD (from above)	64.2	
Level of service, LOSd (from above)	D	

-----Average Travel Speed with Passing Lane-----

Downstream length of two-lane highway within effective length of passing lane for average travel speed, Lde	-	mi
Length of two-lane highway downstream of effective length of the passing lane for average travel speed, Ld	-	mi
Adj. factor for the effect of passing lane on average speed, fpl	-	
Average travel speed including passing lane, ATSp1	-	
Percent free flow speed including passing lane, PFFSp1	0.0	%

-----Percent Time-Spent-Following with Passing Lane-----

Downstream length of two-lane highway within effective length of passing lane for percent time-spent-following, Lde	-	mi
Length of two-lane highway downstream of effective length of the passing lane for percent time-spent-following, Ld	-	mi
Adj. factor for the effect of passing lane on percent time-spent-following, fpl	-	
Percent time-spent-following including passing lane, PTSFpl	-	%

-----Level of Service and Other Performance Measures with Passing Lane-----

Level of service including passing lane, LOSpl	E	
Peak 15-min total travel time, TT15	-	veh-h

-----Bicycle Level of Service-----

Posted speed limit, Sp	55
Percent of segment with occupied on-highway parking	0
Pavement rating, P	3
Flow rate in outside lane, vOL	353.3
Effective width of outside lane, We	14.00
Effective speed factor, St	4.79
Bicycle LOS Score, BLOS	5.36
Bicycle LOS	E

Notes:

1. Note that the adjustment factor for level terrain is 1.00, as level terrain is one of the base conditions. For the purpose of grade adjustment, specific downgrade segments are treated as level terrain.
2. If v_i (v_d or v_o) $\geq 1,700$ pc/h, terminate analysis-the LOS is F.
3. For the analysis direction only and for $v > 200$ veh/h.
4. For the analysis direction only.
5. Use alternative Exhibit 15-14 if some trucks operate at crawl speeds on a specific downgrade.

Phone: Fax:
E-Mail:

-----Directional Two-Lane Highway Segment Analysis-----

Analyst kda
Agency/Co.
Date Performed 3/9/2020
Analysis Time Period PM Peak
Highway SR 49
From/To SR 193 TO COLOMA
Jurisdiction Caltrans
Analysis Year 2040
Description Cool Dollar General

-----Input Data-----

Highway class	Class 1	Peak hour factor, PHF	0.92	
Shoulder width	2.0 ft	% Trucks and buses	6	%
Lane width	12.0 ft	% Trucks crawling	0.0	%
Segment length	8.0 mi	Truck crawl speed	0.0	mi/hr
Terrain type	Specific Grade	% Recreational vehicles	4	%
Grade: Length	0.25 mi	% No-passing zones	100	%
Up/down	3.0 %	Access point density	8	/mi

Analysis direction volume, Vd 330 veh/h
Opposing direction volume, Vo 325 veh/h

-----Average Travel Speed-----

Direction	Analysis(d)	Opposing (o)
PCE for trucks, ET	2.2	1.3
PCE for RVs, ER	1.0	1.0
Heavy-vehicle adj. factor,(note-5) fHV	0.931	0.982
Grade adj. factor,(note-1) fg	0.89	1.00
Directional flow rate,(note-2) vi	433 pc/h	360 pc/h

Free-Flow Speed from Field Measurement:

Field measured speed,(note-3) S FM - mi/h
Observed total demand,(note-3) V - veh/h

Estimated Free-Flow Speed:

Base free-flow speed,(note-3) BFfS 55.0 mi/h
Adj. for lane and shoulder width,(note-3) fLS 2.6 mi/h
Adj. for access point density,(note-3) fA 2.0 mi/h

Free-flow speed, FFfSd 50.4 mi/h

Adjustment for no-passing zones, fnp 3.0 mi/h
Average travel speed, ATfSd 41.3 mi/h
Percent Free Flow Speed, PFfS 81.9 %

-----Percent Time-Spent-Following-----

Direction	Analysis(d)	Opposing (o)	
PCE for trucks, ET	1.0	1.1	
PCE for RVs, ER	1.0	1.0	
Heavy-vehicle adjustment factor, fHV	1.000	0.994	
Grade adjustment factor,(note-1) fg	0.96	1.00	
Directional flow rate,(note-2) vi	372 pc/h	355 pc/h	
Base percent time-spent-following,(note-4) BPTSFD	39.6	%	
Adjustment for no-passing zones, fnp	50.2		
Percent time-spent-following, PTSFD	65.3	%	

-----Level of Service and Other Performance Measures-----

Level of service, LOS	D	
Volume to capacity ratio, v/c	0.25	
Peak 15-min vehicle-miles of travel, VMT15	717	veh-mi
Peak-hour vehicle-miles of travel, VMT60	2640	veh-mi
Peak 15-min total travel time, TT15	17.4	veh-h
Capacity from ATS, CdATS	1407	veh/h
Capacity from PTSF, CdPTSF	1640	veh/h
Directional Capacity	1407	veh/h

-----Passing Lane Analysis-----

Total length of analysis segment, Lt	8.0	mi
Length of two-lane highway upstream of the passing lane, Lu	-	mi
Length of passing lane including tapers, Lpl	-	mi
Average travel speed, ATSD (from above)	41.3	mi/h
Percent time-spent-following, PTSFD (from above)	65.3	
Level of service, LOSd (from above)	D	

-----Average Travel Speed with Passing Lane-----

Downstream length of two-lane highway within effective length of passing lane for average travel speed, Lde	-	mi
Length of two-lane highway downstream of effective length of the passing lane for average travel speed, Ld	-	mi
Adj. factor for the effect of passing lane on average speed, fpl	-	
Average travel speed including passing lane, ATSp1	-	
Percent free flow speed including passing lane, PFFSp1	0.0	%

-----Percent Time-Spent-Following with Passing Lane-----

Downstream length of two-lane highway within effective length of passing lane for percent time-spent-following, Lde	-	mi
Length of two-lane highway downstream of effective length of the passing lane for percent time-spent-following, Ld	-	mi
Adj. factor for the effect of passing lane on percent time-spent-following, fpl	-	
Percent time-spent-following including passing lane, PTSFpl	-	%

-----Level of Service and Other Performance Measures with Passing Lane-----

Level of service including passing lane, LOSpl	E	
Peak 15-min total travel time, TT15	-	veh-h

-----Bicycle Level of Service-----

Posted speed limit, Sp	55
Percent of segment with occupied on-highway parking	0
Pavement rating, P	3
Flow rate in outside lane, vOL	358.7
Effective width of outside lane, We	14.00
Effective speed factor, St	4.79
Bicycle LOS Score, BLOS	5.37
Bicycle LOS	E

Notes:

1. Note that the adjustment factor for level terrain is 1.00, as level terrain is one of the base conditions. For the purpose of grade adjustment, specific downgrade segments are treated as level terrain.
2. If v_i (v_d or v_o) $\geq 1,700$ pc/h, terminate analysis-the LOS is F.
3. For the analysis direction only and for $v > 200$ veh/h.
4. For the analysis direction only.
5. Use alternative Exhibit 15-14 if some trucks operate at crawl speeds on a specific downgrade.

Phone: Fax:
E-Mail:

-----Directional Two-Lane Highway Segment Analysis-----

Analyst kda
Agency/Co.
Date Performed 3/9/2020
Analysis Time Period PM Peak
Highway SR 193
From/To SR 49 TO GEORGETOWN
Jurisdiction Caltrans
Analysis Year 2040
Description Cool Dollar General

-----Input Data-----

Highway class	Class 1	Peak hour factor, PHF	0.92	
Shoulder width	2.0 ft	% Trucks and buses	6	%
Lane width	12.0 ft	% Trucks crawling	0.0	%
Segment length	8.0 mi	Truck crawl speed	0.0	mi/hr
Terrain type	Specific Grade	% Recreational vehicles	4	%
Grade: Length	0.25 mi	% No-passing zones	100	%
Up/down	3.0 %	Access point density	8	/mi

Analysis direction volume, Vd 530 veh/h
Opposing direction volume, Vo 240 veh/h

-----Average Travel Speed-----

Direction	Analysis(d)	Opposing (o)
PCE for trucks, ET	1.8	1.4
PCE for RVs, ER	1.0	1.0
Heavy-vehicle adj. factor,(note-5) fHV	0.954	0.977
Grade adj. factor,(note-1) fg	1.00	1.00
Directional flow rate,(note-2) vi	604 pc/h	267 pc/h

Free-Flow Speed from Field Measurement:

Field measured speed,(note-3) S FM - mi/h
Observed total demand,(note-3) V - veh/h

Estimated Free-Flow Speed:

Base free-flow speed,(note-3) BFFS 55.0 mi/h
Adj. for lane and shoulder width,(note-3) fLS 2.6 mi/h
Adj. for access point density,(note-3) fA 2.0 mi/h

Free-flow speed, FFSd 50.4 mi/h

Adjustment for no-passing zones, fnp 3.6 mi/h
Average travel speed, ATSD 40.1 mi/h
Percent Free Flow Speed, PFFS 79.5 %

-----Percent Time-Spent-Following-----

Direction	Analysis(d)	Opposing (o)	
PCE for trucks, ET	1.0	1.1	
PCE for RVs, ER	1.0	1.0	
Heavy-vehicle adjustment factor, fHV	1.000	0.994	
Grade adjustment factor,(note-1) fg	0.92	1.00	
Directional flow rate,(note-2) vi	626 pc/h	262 pc/h	
Base percent time-spent-following,(note-4) BPTSFD	53.2	%	
Adjustment for no-passing zones, fnp	34.2		
Percent time-spent-following, PTSFD	77.3	%	

-----Level of Service and Other Performance Measures-----

Level of service, LOS	D	
Volume to capacity ratio, v/c	0.36	
Peak 15-min vehicle-miles of travel, VMT15	1152	veh-mi
Peak-hour vehicle-miles of travel, VMT60	4240	veh-mi
Peak 15-min total travel time, TT15	28.8	veh-h
Capacity from ATS, CdATS	1348	veh/h
Capacity from PTSF, CdPTSF	1662	veh/h
Directional Capacity	1348	veh/h

-----Passing Lane Analysis-----

Total length of analysis segment, Lt	8.0	mi
Length of two-lane highway upstream of the passing lane, Lu	-	mi
Length of passing lane including tapers, Lpl	-	mi
Average travel speed, ATSD (from above)	40.1	mi/h
Percent time-spent-following, PTSFD (from above)	77.3	
Level of service, LOSd (from above)	D	

-----Average Travel Speed with Passing Lane-----

Downstream length of two-lane highway within effective length of passing lane for average travel speed, Lde	-	mi
Length of two-lane highway downstream of effective length of the passing lane for average travel speed, Ld	-	mi
Adj. factor for the effect of passing lane on average speed, fpl	-	
Average travel speed including passing lane, ATSp1	-	
Percent free flow speed including passing lane, PFFSp1	0.0	%

-----Percent Time-Spent-Following with Passing Lane-----

Downstream length of two-lane highway within effective length of passing lane for percent time-spent-following, Lde	-	mi
Length of two-lane highway downstream of effective length of the passing lane for percent time-spent-following, Ld	-	mi
Adj. factor for the effect of passing lane on percent time-spent-following, fpl	-	
Percent time-spent-following including passing lane, PTSFpl	-	%

-----Level of Service and Other Performance Measures with Passing Lane-----

Level of service including passing lane, LOSpl	E	
Peak 15-min total travel time, TT15	-	veh-h

-----Bicycle Level of Service-----

Posted speed limit, Sp	55
Percent of segment with occupied on-highway parking	0
Pavement rating, P	3
Flow rate in outside lane, vOL	576.1
Effective width of outside lane, We	14.00
Effective speed factor, St	4.79
Bicycle LOS Score, BLOS	5.61
Bicycle LOS	F

Notes:

1. Note that the adjustment factor for level terrain is 1.00, as level terrain is one of the base conditions. For the purpose of grade adjustment, specific downgrade segments are treated as level terrain.
2. If v_i (v_d or v_o) $\geq 1,700$ pc/h, terminate analysis-the LOS is F.
3. For the analysis direction only and for $v > 200$ veh/h.
4. For the analysis direction only.
5. Use alternative Exhibit 15-14 if some trucks operate at crawl speeds on a specific downgrade.

Phone: Fax:
E-Mail:

----- Directional Two-Lane Highway Segment Analysis -----

Analyst kda
Agency/Co.
Date Performed 3/9/2020
Analysis Time Period PM Peak
Highway SR 193
From/To SR 49 TO GEORGETOWN
Jurisdiction Caltrans
Analysis Year 2040
Description Cool Dollar General

----- Input Data -----

Highway class	Class 1		Peak hour factor, PHF	0.92	
Shoulder width	2.0	ft	% Trucks and buses	6	%
Lane width	12.0	ft	% Trucks crawling	0.0	%
Segment length	8.0	mi	Truck crawl speed	0.0	mi/hr
Terrain type	Rolling		% Recreational vehicles	4	%
Grade: Length	-	mi	% No-passing zones	100	%
Up/down	-	%	Access point density	8	/mi

Analysis direction volume, Vd 240 veh/h
Opposing direction volume, Vo 530 veh/h

----- Average Travel Speed -----

Direction	Analysis(d)	Opposing (o)
PCE for trucks, ET	2.2	1.7
PCE for RVs, ER	1.1	1.1
Heavy-vehicle adj. factor, (note-5) fHV	0.929	0.956
Grade adj. factor, (note-1) fg	0.80	0.97
Directional flow rate, (note-2) vi	351 pc/h	621 pc/h

Free-Flow Speed from Field Measurement:

Field measured speed, (note-3) S FM - mi/h
Observed total demand, (note-3) V - veh/h

Estimated Free-Flow Speed:

Base free-flow speed, (note-3) BFfs 55.0 mi/h
Adj. for lane and shoulder width, (note-3) fLS 2.6 mi/h
Adj. for access point density, (note-3) fA 2.0 mi/h

Free-flow speed, FFsd 50.4 mi/h

Adjustment for no-passing zones, fnp 1.8 mi/h
Average travel speed, ATsd 41.0 mi/h
Percent Free Flow Speed, PFFS 81.4 %

-----Percent Time-Spent-Following-----

Direction	Analysis(d)	Opposing (o)	
PCE for trucks, ET	1.7	1.2	
PCE for RVs, ER	1.0	1.0	
Heavy-vehicle adjustment factor, fHV	0.960	0.988	
Grade adjustment factor,(note-1) fg	0.83	0.97	
Directional flow rate,(note-2) vi	328 pc/h	601 pc/h	
Base percent time-spent-following,(note-4) BPTSFD	39.9	%	
Adjustment for no-passing zones, fnp	33.3		
Percent time-spent-following, PTSFD	51.7	%	

-----Level of Service and Other Performance Measures-----

Level of service, LOS	D	
Volume to capacity ratio, v/c	0.21	
Peak 15-min vehicle-miles of travel, VMT15	522	veh-mi
Peak-hour vehicle-miles of travel, VMT60	1920	veh-mi
Peak 15-min total travel time, TT15	12.7	veh-h
Capacity from ATS, CdATS	1576	veh/h
Capacity from PTSF, CdPTSF	1649	veh/h
Directional Capacity	1576	veh/h

-----Passing Lane Analysis-----

Total length of analysis segment, Lt	8.0	mi
Length of two-lane highway upstream of the passing lane, Lu	-	mi
Length of passing lane including tapers, Lpl	-	mi
Average travel speed, ATSD (from above)	41.0	mi/h
Percent time-spent-following, PTSFD (from above)	51.7	
Level of service, LOSd (from above)	D	

-----Average Travel Speed with Passing Lane-----

Downstream length of two-lane highway within effective length of passing lane for average travel speed, Lde	-	mi
Length of two-lane highway downstream of effective length of the passing lane for average travel speed, Ld	-	mi
Adj. factor for the effect of passing lane on average speed, fpl	-	
Average travel speed including passing lane, ATSp1	-	
Percent free flow speed including passing lane, PFFSp1	0.0	%

-----Percent Time-Spent-Following with Passing Lane-----

Downstream length of two-lane highway within effective length of passing lane for percent time-spent-following, Lde	-	mi
Length of two-lane highway downstream of effective length of the passing lane for percent time-spent-following, Ld	-	mi
Adj. factor for the effect of passing lane on percent time-spent-following, fpl	-	
Percent time-spent-following including passing lane, PTSFpl	-	%

-----Level of Service and Other Performance Measures with Passing Lane-----

Level of service including passing lane, LOSpl	E	
Peak 15-min total travel time, TT15	-	veh-h

-----Bicycle Level of Service-----

Posted speed limit, Sp	55
Percent of segment with occupied on-highway parking	0
Pavement rating, P	3
Flow rate in outside lane, vOL	260.9
Effective width of outside lane, We	14.00
Effective speed factor, St	4.79
Bicycle LOS Score, BLOS	5.21
Bicycle LOS	E

Notes:

1. Note that the adjustment factor for level terrain is 1.00, as level terrain is one of the base conditions. For the purpose of grade adjustment, specific downgrade segments are treated as level terrain.
2. If v_i (v_d or v_o) $\geq 1,700$ pc/h, terminate analysis-the LOS is F.
3. For the analysis direction only and for $v > 200$ veh/h.
4. For the analysis direction only.
5. Use alternative Exhibit 15-14 if some trucks operate at crawl speeds on a specific downgrade.

Phone: Fax:
E-Mail:

-----Directional Two-Lane Highway Segment Analysis-----

Analyst kda
Agency/Co.
Date Performed 3/9/2020
Analysis Time Period PM Peak
Highway SR 49
From/To Auburn to SR 193
Jurisdiction Caltrans
Analysis Year 2040 PLUS DOLLAR GENERAL
Description Cool Dollar General

-----Input Data-----

Highway class	Class 1		Peak hour factor, PHF	0.92	
Shoulder width	2.0	ft	% Trucks and buses	6	%
Lane width	12.0	ft	% Trucks crawling	0.0	%
Segment length	8.0	mi	Truck crawl speed	0.0	mi/hr
Terrain type	Rolling		% Recreational vehicles	4	%
Grade: Length	-	mi	% No-passing zones	100	%
Up/down	-	%	Access point density	8	/mi

Analysis direction volume, Vd 427 veh/h
Opposing direction volume, Vo 737 veh/h

-----Average Travel Speed-----

Direction	Analysis(d)	Opposing (o)
PCE for trucks, ET	1.9	1.4
PCE for RVs, ER	1.1	1.1
Heavy-vehicle adj. factor,(note-5) fHV	0.945	0.973
Grade adj. factor,(note-1) fg	0.93	0.99
Directional flow rate,(note-2) vi	528 pc/h	832 pc/h

Free-Flow Speed from Field Measurement:

Field measured speed,(note-3) S FM - mi/h
Observed total demand,(note-3) V - veh/h

Estimated Free-Flow Speed:

Base free-flow speed,(note-3) BFfS 55.0 mi/h
Adj. for lane and shoulder width,(note-3) fLS 2.6 mi/h
Adj. for access point density,(note-3) fA 2.0 mi/h

Free-flow speed, FFfSd 50.4 mi/h

Adjustment for no-passing zones, fnp 1.3 mi/h
Average travel speed, ATfSd 38.6 mi/h
Percent Free Flow Speed, PFFS 76.5 %

-----Percent Time-Spent-Following-----

Direction	Analysis(d)	Opposing (o)		
PCE for trucks, ET	1.4	1.0		
PCE for RVs, ER	1.0	1.0		
Heavy-vehicle adjustment factor, fHV	0.977	1.000		
Grade adjustment factor,(note-1) fg	0.94	1.00		
Directional flow rate,(note-2) vi	506	801	pc/h	pc/h
Base percent time-spent-following,(note-4) BPTSFD	55.3	%		
Adjustment for no-passing zones, fnp	27.8			
Percent time-spent-following, PTSFD	66.1	%		

-----Level of Service and Other Performance Measures-----

Level of service, LOS	E		
Volume to capacity ratio, v/c	0.31		
Peak 15-min vehicle-miles of travel, VMT15	928	veh-mi	
Peak-hour vehicle-miles of travel, VMT60	3416	veh-mi	
Peak 15-min total travel time, TT15	24.1	veh-h	
Capacity from ATS, CdATS	1638	veh/h	
Capacity from PTSF, CdPTSF	1700	veh/h	
Directional Capacity	1638	veh/h	

-----Passing Lane Analysis-----

Total length of analysis segment, Lt	8.0	mi
Length of two-lane highway upstream of the passing lane, Lu	-	mi
Length of passing lane including tapers, Lpl	-	mi
Average travel speed, ATSD (from above)	38.6	mi/h
Percent time-spent-following, PTSFD (from above)	66.1	
Level of service, LOSd (from above)	E	

-----Average Travel Speed with Passing Lane-----

Downstream length of two-lane highway within effective length of passing lane for average travel speed, Lde	-	mi
Length of two-lane highway downstream of effective length of the passing lane for average travel speed, Ld	-	mi
Adj. factor for the effect of passing lane on average speed, fpl	-	
Average travel speed including passing lane, ATSp1	-	
Percent free flow speed including passing lane, PFFSp1	0.0	%

-----Percent Time-Spent-Following with Passing Lane-----

Downstream length of two-lane highway within effective length of passing lane for percent time-spent-following, Lde	-	mi
Length of two-lane highway downstream of effective length of the passing lane for percent time-spent-following, Ld	-	mi
Adj. factor for the effect of passing lane on percent time-spent-following, fpl	-	
Percent time-spent-following including passing lane, PTSFpl	-	%

-----Level of Service and Other Performance Measures with Passing Lane-----

Level of service including passing lane, LOSpl	E	
Peak 15-min total travel time, TT15	-	veh-h

-----Bicycle Level of Service-----

Posted speed limit, Sp	55
Percent of segment with occupied on-highway parking	0
Pavement rating, P	3
Flow rate in outside lane, vOL	464.1
Effective width of outside lane, We	14.00
Effective speed factor, St	4.79
Bicycle LOS Score, BLOS	5.50
Bicycle LOS	E

Notes:

1. Note that the adjustment factor for level terrain is 1.00, as level terrain is one of the base conditions. For the purpose of grade adjustment, specific downgrade segments are treated as level terrain.
2. If v_i (v_d or v_o) $\geq 1,700$ pc/h, terminate analysis-the LOS is F.
3. For the analysis direction only and for $v > 200$ veh/h.
4. For the analysis direction only.
5. Use alternative Exhibit 15-14 if some trucks operate at crawl speeds on a specific downgrade.

Phone: Fax:
E-Mail:

-----Directional Two-Lane Highway Segment Analysis-----

Analyst kda
Agency/Co.
Date Performed 3/9/2020
Analysis Time Period PM Peak
Highway SR 49
From/To Auburn to Sr 193
Jurisdiction Caltrans
Analysis Year 2040 PLUS DOLLAR GENERAL
Description Cool Dollar General

-----Input Data-----

Highway class	Class 1		Peak hour factor, PHF	0.92	
Shoulder width	2.0	ft	% Trucks and buses	6	%
Lane width	12.0	ft	% Trucks crawling	0.0	%
Segment length	8.0	mi	Truck crawl speed	0.0	mi/hr
Terrain type	Rolling		% Recreational vehicles	4	%
Grade: Length	-	mi	% No-passing zones	100	%
Up/down	-	%	Access point density	8	/mi

Analysis direction volume, Vd 737 veh/h
Opposing direction volume, Vo 427 veh/h

-----Average Travel Speed-----

Direction	Analysis(d)	Opposing (o)
PCE for trucks, ET	1.4	1.9
PCE for RVs, ER	1.1	1.1
Heavy-vehicle adj. factor,(note-5) fHV	0.973	0.945
Grade adj. factor,(note-1) fg	0.99	0.93
Directional flow rate,(note-2) vi	832 pc/h	528 pc/h

Free-Flow Speed from Field Measurement:

Field measured speed,(note-3) S FM - mi/h
Observed total demand,(note-3) V - veh/h

Estimated Free-Flow Speed:

Base free-flow speed,(note-3) BFfS 55.0 mi/h
Adj. for lane and shoulder width,(note-3) fLS 2.6 mi/h
Adj. for access point density,(note-3) fA 2.0 mi/h

Free-flow speed, FFfSd 50.4 mi/h

Adjustment for no-passing zones, fnp 2.2 mi/h
Average travel speed, ATfSd 37.7 mi/h
Percent Free Flow Speed, PFfS 74.7 %

-----Percent Time-Spent-Following-----

Direction	Analysis(d)	Opposing (o)	
PCE for trucks, ET	1.0	1.4	
PCE for RVs, ER	1.0	1.0	
Heavy-vehicle adjustment factor, fHV	1.000	0.977	
Grade adjustment factor,(note-1) fg	1.00	0.94	
Directional flow rate,(note-2) vi	801 pc/h	506 pc/h	
Base percent time-spent-following,(note-4) BPTSFD	67.1	%	
Adjustment for no-passing zones, fnp	27.8		
Percent time-spent-following, PTSFD	84.1	%	

-----Level of Service and Other Performance Measures-----

Level of service, LOS	E	
Volume to capacity ratio, v/c	0.49	
Peak 15-min vehicle-miles of travel, VMT15	1602	veh-mi
Peak-hour vehicle-miles of travel, VMT60	5896	veh-mi
Peak 15-min total travel time, TT15	42.5	veh-h
Capacity from ATS, CdATS	1536	veh/h
Capacity from PTSF, CdPTSF	1613	veh/h
Directional Capacity	1536	veh/h

-----Passing Lane Analysis-----

Total length of analysis segment, Lt	8.0	mi
Length of two-lane highway upstream of the passing lane, Lu	-	mi
Length of passing lane including tapers, Lpl	-	mi
Average travel speed, ATSD (from above)	37.7	mi/h
Percent time-spent-following, PTSFD (from above)	84.1	
Level of service, LOSd (from above)	E	

-----Average Travel Speed with Passing Lane-----

Downstream length of two-lane highway within effective length of passing lane for average travel speed, Lde	-	mi
Length of two-lane highway downstream of effective length of the passing lane for average travel speed, Ld	-	mi
Adj. factor for the effect of passing lane on average speed, fpl	-	
Average travel speed including passing lane, ATSp1	-	
Percent free flow speed including passing lane, PFFSp1	0.0	%

-----Percent Time-Spent-Following with Passing Lane-----

Downstream length of two-lane highway within effective length of passing lane for percent time-spent-following, Lde	-	mi
Length of two-lane highway downstream of effective length of the passing lane for percent time-spent-following, Ld	-	mi
Adj. factor for the effect of passing lane on percent time-spent-following, fpl	-	
Percent time-spent-following including passing lane, PTSFpl	-	%

-----Level of Service and Other Performance Measures with Passing Lane-----

Level of service including passing lane, LOSpl	E	
Peak 15-min total travel time, TT15	-	veh-h

-----Bicycle Level of Service-----

Posted speed limit, Sp	55
Percent of segment with occupied on-highway parking	0
Pavement rating, P	3
Flow rate in outside lane, vOL	801.1
Effective width of outside lane, We	14.00
Effective speed factor, St	4.79
Bicycle LOS Score, BLOS	5.77
Bicycle LOS	F

Notes:

1. Note that the adjustment factor for level terrain is 1.00, as level terrain is one of the base conditions. For the purpose of grade adjustment, specific downgrade segments are treated as level terrain.
2. If v_i (v_d or v_o) $\geq 1,700$ pc/h, terminate analysis-the LOS is F.
3. For the analysis direction only and for $v > 200$ veh/h.
4. For the analysis direction only.
5. Use alternative Exhibit 15-14 if some trucks operate at crawl speeds on a specific downgrade.

Phone: Fax:
E-Mail:

-----Directional Two-Lane Highway Segment Analysis-----

Analyst kda
Agency/Co.
Date Performed 3/9/2020
Analysis Time Period PM Peak
Highway SR 49
From/To SR 193 TO COLOMA
Jurisdiction Caltrans
Analysis Year 2040 PLUS DOLLAR GENERAL
Description Cool Dollar General

-----Input Data-----

Highway class	Class 1	Peak hour factor, PHF	0.92	
Shoulder width	2.0 ft	% Trucks and buses	6	%
Lane width	12.0 ft	% Trucks crawling	0.0	%
Segment length	8.0 mi	Truck crawl speed	0.0	mi/hr
Terrain type	Specific Grade	% Recreational vehicles	4	%
Grade: Length	0.25 mi	% No-passing zones	100	%
Up/down	3.0 %	Access point density	8	/mi

Analysis direction volume, Vd 334 veh/h
Opposing direction volume, Vo 338 veh/h

-----Average Travel Speed-----

Direction	Analysis(d)	Opposing (o)
PCE for trucks, ET	2.2	1.3
PCE for RVs, ER	1.0	1.0
Heavy-vehicle adj. factor,(note-5) fHV	0.931	0.982
Grade adj. factor,(note-1) fg	0.90	1.00
Directional flow rate,(note-2) vi	433 pc/h	374 pc/h

Free-Flow Speed from Field Measurement:

Field measured speed,(note-3) S FM - mi/h
Observed total demand,(note-3) V - veh/h

Estimated Free-Flow Speed:

Base free-flow speed,(note-3) BFfS 55.0 mi/h
Adj. for lane and shoulder width,(note-3) fLS 2.6 mi/h
Adj. for access point density,(note-3) fA 2.0 mi/h

Free-flow speed, FFfSd 50.4 mi/h

Adjustment for no-passing zones, fnp 2.9 mi/h
Average travel speed, ATfSd 41.3 mi/h
Percent Free Flow Speed, PFfS 81.9 %

-----Percent Time-Spent-Following-----

Direction	Analysis(d)	Opposing (o)	
PCE for trucks, ET	1.0	1.1	
PCE for RVs, ER	1.0	1.0	
Heavy-vehicle adjustment factor, fHV	1.000	0.994	
Grade adjustment factor,(note-1) fg	0.96	1.00	
Directional flow rate,(note-2) vi	377 pc/h	370 pc/h	
Base percent time-spent-following,(note-4) BPTSFD	40.7	%	
Adjustment for no-passing zones, fnp	49.2		
Percent time-spent-following, PTSFD	65.5	%	

-----Level of Service and Other Performance Measures-----

Level of service, LOS	D	
Volume to capacity ratio, v/c	0.25	
Peak 15-min vehicle-miles of travel, VMT15	726	veh-mi
Peak-hour vehicle-miles of travel, VMT60	2672	veh-mi
Peak 15-min total travel time, TT15	17.6	veh-h
Capacity from ATS, CdATS	1424	veh/h
Capacity from PTSF, CdPTSF	1637	veh/h
Directional Capacity	1424	veh/h

-----Passing Lane Analysis-----

Total length of analysis segment, Lt	8.0	mi
Length of two-lane highway upstream of the passing lane, Lu	-	mi
Length of passing lane including tapers, Lpl	-	mi
Average travel speed, ATSD (from above)	41.3	mi/h
Percent time-spent-following, PTSFD (from above)	65.5	
Level of service, LOSd (from above)	D	

-----Average Travel Speed with Passing Lane-----

Downstream length of two-lane highway within effective length of passing lane for average travel speed, Lde	-	mi
Length of two-lane highway downstream of effective length of the passing lane for average travel speed, Ld	-	mi
Adj. factor for the effect of passing lane on average speed, fpl	-	
Average travel speed including passing lane, ATSp1	-	
Percent free flow speed including passing lane, PFFSp1	0.0	%

-----Percent Time-Spent-Following with Passing Lane-----

Downstream length of two-lane highway within effective length of passing lane for percent time-spent-following, Lde	-	mi
Length of two-lane highway downstream of effective length of the passing lane for percent time-spent-following, Ld	-	mi
Adj. factor for the effect of passing lane on percent time-spent-following, fpl	-	
Percent time-spent-following including passing lane, PTSFpl	-	%

-----Level of Service and Other Performance Measures with Passing Lane-----

Level of service including passing lane, LOSpl	E	
Peak 15-min total travel time, TT15	-	veh-h

-----Bicycle Level of Service-----

Posted speed limit, Sp	55
Percent of segment with occupied on-highway parking	0
Pavement rating, P	3
Flow rate in outside lane, vOL	363.0
Effective width of outside lane, We	14.00
Effective speed factor, St	4.79
Bicycle LOS Score, BLOS	5.37
Bicycle LOS	E

Notes:

1. Note that the adjustment factor for level terrain is 1.00, as level terrain is one of the base conditions. For the purpose of grade adjustment, specific downgrade segments are treated as level terrain.
2. If v_i (v_d or v_o) $\geq 1,700$ pc/h, terminate analysis-the LOS is F.
3. For the analysis direction only and for $v > 200$ veh/h.
4. For the analysis direction only.
5. Use alternative Exhibit 15-14 if some trucks operate at crawl speeds on a specific downgrade.

Phone: Fax:
E-Mail:

-----Directional Two-Lane Highway Segment Analysis-----

Analyst kda
Agency/Co.
Date Performed 3/9/2020
Analysis Time Period PM Peak
Highway SR 49
From/To SR 193 TO COLOMA
Jurisdiction Caltrans
Analysis Year 2040 PLUS DOLLAR GENERAL
Description Cool Dollar General

-----Input Data-----

Highway class	Class 1	Peak hour factor, PHF	0.92	
Shoulder width	2.0 ft	% Trucks and buses	6	%
Lane width	12.0 ft	% Trucks crawling	0.0	%
Segment length	8.0 mi	Truck crawl speed	0.0	mi/hr
Terrain type	Specific Grade	% Recreational vehicles	4	%
Grade: Length	0.25 mi	% No-passing zones	100	%
Up/down	3.0 %	Access point density	8	/mi

Analysis direction volume, Vd 338 veh/h
Opposing direction volume, Vo 334 veh/h

-----Average Travel Speed-----

Direction	Analysis(d)	Opposing (o)
PCE for trucks, ET	2.2	1.3
PCE for RVs, ER	1.0	1.0
Heavy-vehicle adj. factor,(note-5) fHV	0.931	0.982
Grade adj. factor,(note-1) fg	0.90	1.00
Directional flow rate,(note-2) vi	438 pc/h	370 pc/h

Free-Flow Speed from Field Measurement:

Field measured speed,(note-3) S FM - mi/h
Observed total demand,(note-3) V - veh/h

Estimated Free-Flow Speed:

Base free-flow speed,(note-3) BFfS 55.0 mi/h
Adj. for lane and shoulder width,(note-3) fLS 2.6 mi/h
Adj. for access point density,(note-3) fA 2.0 mi/h

Free-flow speed, FFfSd 50.4 mi/h

Adjustment for no-passing zones, fnp 2.9 mi/h
Average travel speed, ATfSd 41.2 mi/h
Percent Free Flow Speed, PFfS 81.8 %

-----Percent Time-Spent-Following-----

Direction	Analysis(d)	Opposing (o)	
PCE for trucks, ET	1.0	1.1	
PCE for RVs, ER	1.0	1.0	
Heavy-vehicle adjustment factor, fHV	1.000	0.994	
Grade adjustment factor,(note-1) fg	0.96	1.00	
Directional flow rate,(note-2) vi	381 pc/h	365 pc/h	
Base percent time-spent-following,(note-4) BPTSFD	41.4	%	
Adjustment for no-passing zones, fnp	49.2		
Percent time-spent-following, PTSFD	66.5	%	

-----Level of Service and Other Performance Measures-----

Level of service, LOS	D	
Volume to capacity ratio, v/c	0.26	
Peak 15-min vehicle-miles of travel, VMT15	735	veh-mi
Peak-hour vehicle-miles of travel, VMT60	2704	veh-mi
Peak 15-min total travel time, TT15	17.8	veh-h
Capacity from ATS, CdATS	1424	veh/h
Capacity from PTSF, CdPTSF	1638	veh/h
Directional Capacity	1424	veh/h

-----Passing Lane Analysis-----

Total length of analysis segment, Lt	8.0	mi
Length of two-lane highway upstream of the passing lane, Lu	-	mi
Length of passing lane including tapers, Lpl	-	mi
Average travel speed, ATSD (from above)	41.2	mi/h
Percent time-spent-following, PTSFD (from above)	66.5	
Level of service, LOSd (from above)	D	

-----Average Travel Speed with Passing Lane-----

Downstream length of two-lane highway within effective length of passing lane for average travel speed, Lde	-	mi
Length of two-lane highway downstream of effective length of the passing lane for average travel speed, Ld	-	mi
Adj. factor for the effect of passing lane on average speed, fpl	-	
Average travel speed including passing lane, ATSp1	-	
Percent free flow speed including passing lane, PFFSp1	0.0	%

-----Percent Time-Spent-Following with Passing Lane-----

Downstream length of two-lane highway within effective length of passing lane for percent time-spent-following, Lde	-	mi
Length of two-lane highway downstream of effective length of the passing lane for percent time-spent-following, Ld	-	mi
Adj. factor for the effect of passing lane on percent time-spent-following, fpl	-	
Percent time-spent-following including passing lane, PTSFpl	-	%

-----Level of Service and Other Performance Measures with Passing Lane-----

Level of service including passing lane, LOSpl	E	
Peak 15-min total travel time, TT15	-	veh-h

-----Bicycle Level of Service-----

Posted speed limit, Sp	55
Percent of segment with occupied on-highway parking	0
Pavement rating, P	3
Flow rate in outside lane, vOL	367.4
Effective width of outside lane, We	14.00
Effective speed factor, St	4.79
Bicycle LOS Score, BLOS	5.38
Bicycle LOS	E

Notes:

1. Note that the adjustment factor for level terrain is 1.00, as level terrain is one of the base conditions. For the purpose of grade adjustment, specific downgrade segments are treated as level terrain.
2. If v_i (v_d or v_o) $\geq 1,700$ pc/h, terminate analysis-the LOS is F.
3. For the analysis direction only and for $v > 200$ veh/h.
4. For the analysis direction only.
5. Use alternative Exhibit 15-14 if some trucks operate at crawl speeds on a specific downgrade.

Phone: Fax:
E-Mail:

-----Directional Two-Lane Highway Segment Analysis-----

Analyst kda
Agency/Co.
Date Performed 3/9/2020
Analysis Time Period PM Peak
Highway SR 193
From/To SR 49 TO GEORGETOWN
Jurisdiction Caltrans
Analysis Year 2040 PLUS DOLLAR GENERAL
Description Cool Dollar General

-----Input Data-----

Highway class	Class 1	Peak hour factor, PHF	0.92	
Shoulder width	2.0 ft	% Trucks and buses	6	%
Lane width	12.0 ft	% Trucks crawling	0.0	%
Segment length	8.0 mi	Truck crawl speed	0.0	mi/hr
Terrain type	Specific Grade	% Recreational vehicles	4	%
Grade: Length	0.25 mi	% No-passing zones	100	%
Up/down	-3.0 %	Access point density	8	/mi

Analysis direction volume, Vd 538 veh/h
Opposing direction volume, Vo 249 veh/h

-----Average Travel Speed-----

Direction	Analysis(d)	Opposing (o)
PCE for trucks, ET	1.1	2.3
PCE for RVs, ER	1.0	1.1
Heavy-vehicle adj. factor,(note-5) fHV	0.994	0.923
Grade adj. factor,(note-1) fg	1.00	0.86
Directional flow rate,(note-2) vi	588 pc/h	341 pc/h

Free-Flow Speed from Field Measurement:

Field measured speed,(note-3) S FM - mi/h
Observed total demand,(note-3) V - veh/h

Estimated Free-Flow Speed:

Base free-flow speed,(note-3) BFFS 55.0 mi/h
Adj. for lane and shoulder width,(note-3) fLS 2.6 mi/h
Adj. for access point density,(note-3) fA 2.0 mi/h

Free-flow speed, FFSd 50.4 mi/h

Adjustment for no-passing zones, fnp 3.1 mi/h
Average travel speed, ATSD 40.1 mi/h
Percent Free Flow Speed, PFFS 79.6 %

-----Percent Time-Spent-Following-----

Direction	Analysis(d)	Opposing (o)	
PCE for trucks, ET	1.0	1.0	
PCE for RVs, ER	1.0	1.0	
Heavy-vehicle adjustment factor, fHV	1.000	1.000	
Grade adjustment factor,(note-1) fg	1.00	0.98	
Directional flow rate,(note-2) vi	585	277	pc/h
Base percent time-spent-following,(note-4) BPTSFD	52.4	%	
Adjustment for no-passing zones, fnp	35.1		
Percent time-spent-following, PTSFD	76.2	%	

-----Level of Service and Other Performance Measures-----

Level of service, LOS	D	
Volume to capacity ratio, v/c	0.35	
Peak 15-min vehicle-miles of travel, VMT15	1170	veh-mi
Peak-hour vehicle-miles of travel, VMT60	4304	veh-mi
Peak 15-min total travel time, TT15	29.2	veh-h
Capacity from ATS, CdATS	1660	veh/h
Capacity from PTSF, CdPTSF	1690	veh/h
Directional Capacity	1660	veh/h

-----Passing Lane Analysis-----

Total length of analysis segment, Lt	8.0	mi
Length of two-lane highway upstream of the passing lane, Lu	-	mi
Length of passing lane including tapers, Lpl	-	mi
Average travel speed, ATSD (from above)	40.1	mi/h
Percent time-spent-following, PTSFD (from above)	76.2	
Level of service, LOSd (from above)	D	

-----Average Travel Speed with Passing Lane-----

Downstream length of two-lane highway within effective length of passing lane for average travel speed, Lde	-	mi
Length of two-lane highway downstream of effective length of the passing lane for average travel speed, Ld	-	mi
Adj. factor for the effect of passing lane on average speed, fpl	-	
Average travel speed including passing lane, ATSp1	-	
Percent free flow speed including passing lane, PFFSp1	0.0	%

-----Percent Time-Spent-Following with Passing Lane-----

Downstream length of two-lane highway within effective length of passing lane for percent time-spent-following, Lde	-	mi
Length of two-lane highway downstream of effective length of the passing lane for percent time-spent-following, Ld	-	mi
Adj. factor for the effect of passing lane on percent time-spent-following, fpl	-	
Percent time-spent-following including passing lane, PTSFpl	-	%

-----Level of Service and Other Performance Measures with Passing Lane-----

Level of service including passing lane, LOSpl	E	
Peak 15-min total travel time, TT15	-	veh-h

-----Bicycle Level of Service-----

Posted speed limit, Sp	55
Percent of segment with occupied on-highway parking	0
Pavement rating, P	3
Flow rate in outside lane, vOL	584.8
Effective width of outside lane, We	14.00
Effective speed factor, St	4.79
Bicycle LOS Score, BLOS	5.62
Bicycle LOS	F

Notes:

1. Note that the adjustment factor for level terrain is 1.00, as level terrain is one of the base conditions. For the purpose of grade adjustment, specific downgrade segments are treated as level terrain.
2. If v_i (v_d or v_o) $\geq 1,700$ pc/h, terminate analysis-the LOS is F.
3. For the analysis direction only and for $v > 200$ veh/h.
4. For the analysis direction only.
5. Use alternative Exhibit 15-14 if some trucks operate at crawl speeds on a specific downgrade.



Delivery Truck Route—Cool Dollar General

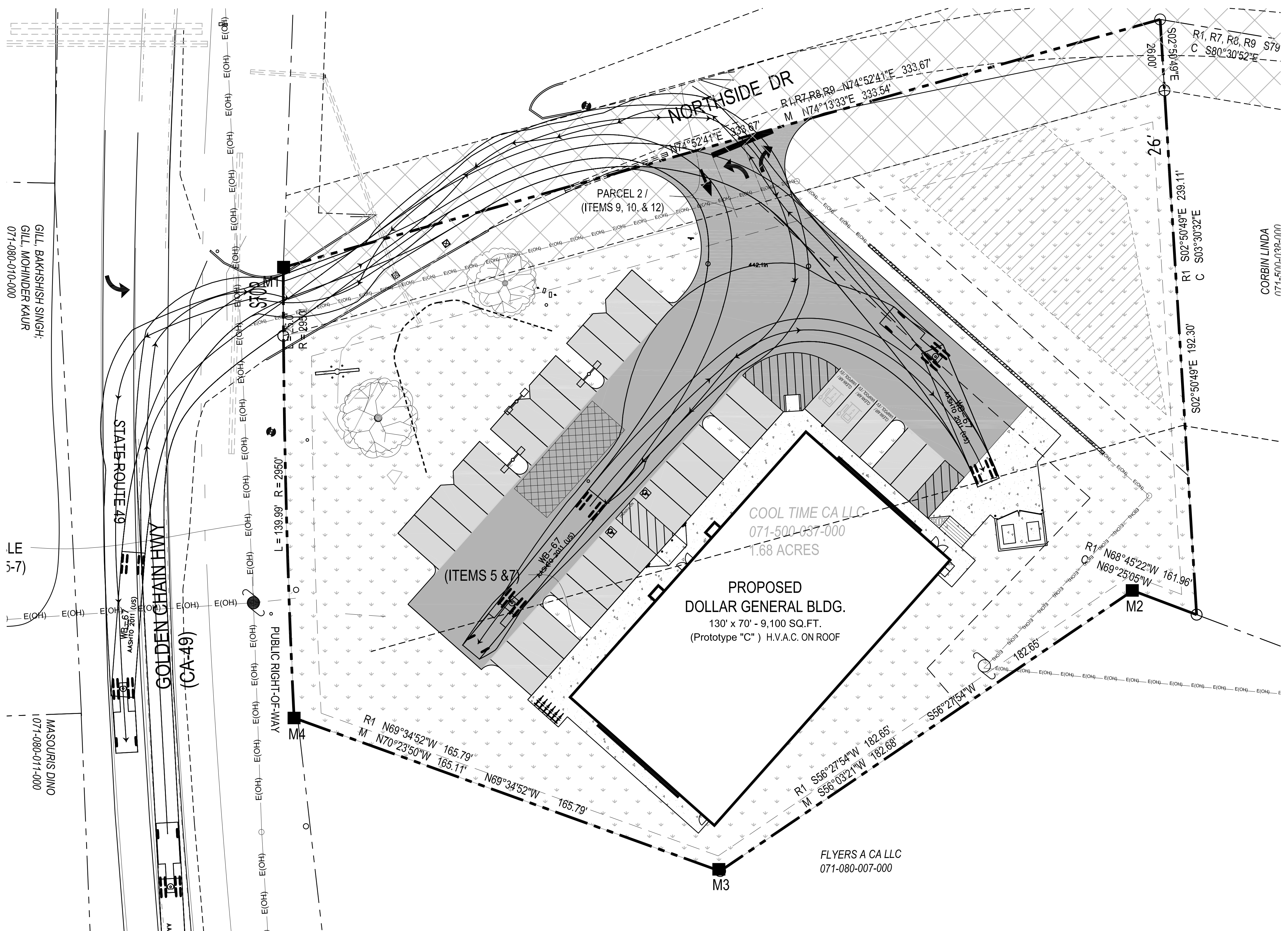

GILL BAKHSHISH SINGH;
GILL MOHINDER KAUR
071-080-010-000

LE
5-7)

MASOURIS DINO
071-080-011-000

CORBIN LINDA
071-500-035-000

FLYERS A CA LLC
071-080-007-000

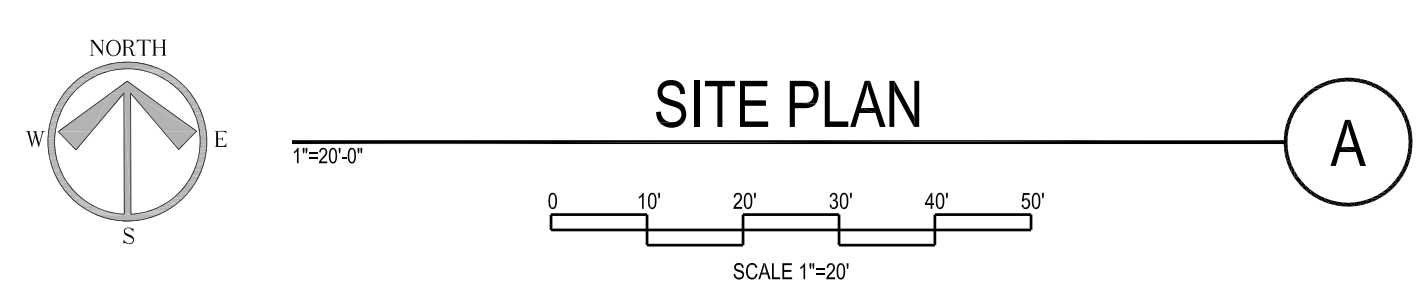

SITE PLAN

(A)

FLOOD ZONE NOTE

FLOOD ZONE CLASSIFICATION IS BASED UPON THE FEDERAL EMERGENCY MANAGEMENT AGENCY (FEMA) FLOOD INSURANCE RATE MAP (FIRM) MAP PANEL NUMBER 0601700175E ALL OF THE PARCEL ARE LOCATED WITHIN ZONE X - DESCRIBED AS AREAS DETERMINED TO BE OUTSIDE THE 0.2% ANNUAL CHANCE FLOODPLAIN.

EXCEPTIONS: per amended title report provided by First American Title Co. order no: 0901-5921611

- (ITEM 1) AN EASEMENT FOR POLE LINES AND INCIDENTAL PURPOSES, RECORDED FEBRUARY 9, 1928 IN BOOK 208, PAGE 216 OF OFFICIAL RECORDS. IN FAVOR OF: PACIFIC GAS AND ELECTRICAL COMPANY, AFFECTS: AS DESCRIBED THEREIN. THE LOCATIONS OF THE EASEMENT CANNOT BE DETERMINED FROM RECORD INFORMATION.
- (ITEM 2) AN EASEMENT FOR POLE LINES AND INCIDENTAL PURPOSES, RECORDED JANUARY 9, 1942 IN BOOK 192, PAGE 84 OF OFFICIAL RECORDS. IN FAVOR OF: PACIFIC GAS AND ELECTRICAL COMPANY, AFFECTS: AS DESCRIBED THEREIN. THE LOCATION OF THE EASEMENT CANNOT BE DETERMINED FROM RECORD INFORMATION.
- (ITEM 3) AN EASEMENT FOR POLE LINES AND INCIDENTAL PURPOSES, RECORDED JUNE 8, 1953 IN BOOK 326, PAGE 158 OF OFFICIAL RECORDS. IN FAVOR OF: PACIFIC GAS AND TELEGRAPH COMPANY, AFFECTS: AS DESCRIBED THEREIN. THE LOCATION OF THE EASEMENT CANNOT BE DETERMINED FROM RECORD INFORMATION.
- (ITEM 4) THE TERMS AND PROVISIONS CONTAINED IN THE DOCUMENT ENTITLED "AGREEMENT TO PAY ROAD IMPROVEMENT FEE" RECORDED JANUARY 5, 1982 IN BOOK 2044, PAGE 91 OF OFFICIAL RECORDS.
- (ITEM 5) AN EASEMENT SHOWN OR DEDICATED ON THE MAP AS REFERRED TO IN THE LEGAL DESCRIPTION, FOR: 50' RADIUS TURNAROUND EASEMENT & NONEXCLUSIVE ROAD AND PUBLIC UTILITIES EASEMENT AND INCIDENTAL PURPOSES.
- (ITEM 6) AN EASEMENT FOR ROAD AND PUBLIC UTILITIES AND INCIDENTAL PURPOSES, RECORDED JANUARY 27, 1982 IN BOOK 2049, PAGE 20 OF OFFICIAL RECORDS. IN FAVOR OF: NEWTON LEVESKIS AND BETTY LEVESKIS, HIS WIFE AS JOINT TENANTS. AFFECTS: NORTHERLY 25 FEET, (DEED FOR APN 071-500-044-000)
- (ITEM 7) A LEASE DATED JANUARY 26, 1983, EXECUTED BY NEWTON G. LEVESKIS AND ELIZABETH J. LEVESKIS, HUSBAND AND WIFE AS LESSOR AND UNITED STATES POSTAL SERVICE AS LESSEE, RECORDED IN INSTRUMENT NO. 10172 IN BOOK 2155, PAGE 197 OF OFFICIAL RECORDS. DEFECTS, LIENS, ENCUMBRANCES OR OTHER MATTERS AFFECTING THE LEASEHOLD ESTATE, WHETHER OR NOT SHOWN BY THE PUBLIC RECORDS. (LEASE FOR APN 071-500-044-000)
- (ITEM 8) AN EASEMENT FOR A 50' NONEXCLUSIVE ROAD AND PUBLIC UTILITIES AND INCIDENTAL PURPOSES, RECORDED MAY 29, 1992 AS INSTRUMENT NO. 33414 IN BOOK 3795, PAGE 385 OF OFFICIAL RECORDS. IN FAVOR OF: JOHN W. DALTON AND PATTY G. DALTON, HUSBAND AND WIFE, AS JOINT TENANT, AS TO AN UNDIVIDED 1/2 INTEREST AND DAVID E. HOPKINS AND MARY A. HOPKINS, HUSBAND AND WIFE, AS JOINT TENANTS, AS TO AN UNDIVIDED 1/2 INTEREST. AFFECTS: AS DESCRIBED THEREIN.

SURVEYORS NOTES

- 1) UNDERGROUND UTILITIES EXIST AND WERE MEASURED CONFORMED WITH THE LOCATIONS ON THE AS-BUILT IMPROVEMENT PLANS. HOWEVER EXACT LOCATIONS ARE NOT KNOWN AND CAN ONLY BE DETERMINED BY CAREFULLY EXCAVATING AND HAND PROBING. ASSISTANCE CAN BE OBTAINED BY CALLING UNDERGROUND SERVICE ALERT (USA) AT 1-800-227-2600. 48 HOURS IN ADVANCE OF ANY EXCAVATION.
- 2) THE PROPERTY IS NOW BEING USED FOR LAND DEVELOPMENT.
- 3) THERE IS NO OBSERVABLE EVIDENCE THAT THE PROPERTY WAS USED AS A SOLID WASTE DUMP, SUMP OR SANITARY LAND FILL.
- 3) THERE ARE SEVERAL TREES ALONG THE ON PROPERTY AND THE TREES LARGER THAN 12-INCH DIAMETER HAVE BEEN NOTED.

SITE LEGEND

	HEAVY DUTY CONCRETE		STAND. DUTY ASPHALT
	HEAVY DUTY ASPHALT		LANDSCAPE/OPEN AREA
	FOUND MONUMENT AS DESCRIBED		(E) SEWER SERVICE
	FOUND 5/8" REBAR WITH CAP STAMPED LS 5161		(E) WATER SERVICE
	CALCULATED POINT, NOTHING FOUND OR SET		(E) FIRE HYDRANT
	FOUND STANDARD MONUMENT IN WELL		(E) STREET LIGHT
	EXISTING		(E) FENCE
	EMBRACES RECORD DATA		(E) TREE - APPROX DRIP LINE WITH TRUNK DIAMETER
	REPRESENTS MEASURED DATA		(E) POWER POLE/ UTILITY POLE
	REPRESENTS CALCULATED DATA		S.N.F. SEARCH NOT FOUND
	P.S.E. (PUBLIC SERVICE EASEMENT)		EDOR EL DORADO COUNTY OFFICIAL RECORDS
	ROS RECORD OF SURVEY		(T) TOTAL
	R/W RIGHT-OF-WAY		

MPA ARCHITECTS, INC.

3578 30th Street
San Diego, CA 92104
V. 619.236.0595
F. 619.236.0557
www.mpa-architects.com

MEMBER
AMERICAN INSTITUTE OF ARCHITECTS

CLIENT

WOODCREST

1410 MAIN STREET, SUITE C
RAMONA, CALIFORNIA 92065

CONTACT: WADE WYLLIE
P: 760-789-5493
e-mail: wade@woodcrestrev.com

PROJECT

A PROPOSED COMMERCIAL DEVELOPMENT FOR:

DOLLAR GENERAL

SEC STATE HWY 49 & NORTHSIDE DR
COOL, CA 95614

REVISIONS

NO.	DESCRIPTION	DATE

REGISTERED ARCHITECT
JOHN RUMSEY
Exp. 3-31-2021
STATE OF CALIFORNIA

SHEET TITLE
ARCHITECTURAL SITE PLAN

DATE: 05-21-20 SCALE: AS NOTED
DRAWN BY: L. DALE DATABASE: 19091
CHECKED BY: SHEET NUMBER:
PROJECT NO: 1-0733 N 1901 of 150

AS1.1