



# COMMUNITY DEVELOPMENT SERVICES

## DEPARTMENT OF TRANSPORTATION

<http://www.edcgov.us/DOT/>

### PLACERVILLE OFFICES:

#### MAIN OFFICE:

2850 Fairlane Court, Placerville, CA 95667  
(530) 621-5900 / (530) 626-0387 Fax

#### CONSTRUCTION & MAINTENANCE:

2441 Headington Road, Placerville, CA 95667  
(530) 642-4909 / (530) 642-0508 Fax

### LAKE TAHOE OFFICES:

#### ENGINEERING:

924 B Emerald Bay Road, South Lake Tahoe, CA 96150  
(530) 573-7900 / (530) 541-7049 Fax

#### MAINTENANCE:

1121 Shakori Drive, South Lake Tahoe, CA 96150  
(530) 573-3180 / (530) 577-8402 Fax

**DATE:** February 21, 2019

**TO:** All Prospective Bidders

**SUBJECT: Addendum No. 1**  
**Bassi Road at Granite Creek Bridge Replacement Project, Contract No. 2777, CIP No. 77128**

Submit proposals for this work with the understanding and full consideration of this Addendum. The revisions declared in this Addendum are essential parts of the Contract.

ITEM NO.	LOCATION, PAGE, OR DRAWING NO.	DESCRIPTION OF CHANGE
1.01	C-11 through C-14	Bidders are instructed to <b>replace</b> pages C-11 through C-14 of the Contract with the attached C-11 REV through C-14 REV
1.02	Agreement - Federal Wage Rates	Bidders are instructed to <b>replace</b> pages C-34 through C-82 of the Contract with the attached C-34 REV through C-82 REV
1.03	P-3 through P-6	Bidders are instructed to <b>replace</b> pages P-3 through P-6 of the Proposal with the attached P-3 REV through P-6 REV.
1.04	Plan Sheet D-2	Bidders are instructed to <b>replace</b> page D-2 of the Plans with the attached D-2.
1.05	Plan Sheets C-1 and C-2	Bidders are instructed to <b>replace</b> page C-1 and C-2 of the Plans with the attached C-1 R and C-2 R.
1.06	Plan Sheets L-2	Bidders are instructed to <b>replace</b> page L-2 of the Plans with the attached L-2.
1.07	SP-87	Bidders are instructed to <b>add</b> the following to Section 83 of the Special Provisions:  <b>Add to section 83-2.03D:</b>  Payment for the Return Cap (Type TA) and End Anchor Assembly (Departure End) is included in the payment for Transition Railing (Type STB).

Indicate receipt of this Addendum by filling in the number of this Addendum in the space provided on the signature page of the Proposal. Holders who have already mailed their Proposal can contact Jennifer Rimoldi at 530-621-7592 (email: [jennifer.rimoldi@edcgov.us](mailto:jennifer.rimoldi@edcgov.us)) to arrange return of their Proposal. Inform all suppliers and subcontractors as necessary.

The Community Development Services, Department of Transportation is only sending this addendum by posting on QuestCDN's website at: <https://www.questcdn.com/>. If you are not a Contract Documents holder, but request a set of documents to bid on this Project, you must comply with the requirements of this Addendum when submitting your bid.

  
\_\_\_\_\_  
Recommended by:  
Matt Smeltzer, Deputy Director,  
Fairlane Engineering

3/21/19  
Date

  
\_\_\_\_\_  
Approved by:  
Rafael Martinez, Director  
Department of Transportation

3/21/19  
Date

**End of Addendum No. 1**

EXHIBIT A

CONTRACTOR'S BID AND BID PRICE SCHEDULE  
 BASSI ROAD AT GRANITE CREEK BRIDGE REPLACEMENT  
 CIP No. 77128, CONTRACT No. 2777

ITEM NO.	ITEM CODE	ITEM DESCRIPTION	UNIT OF MEASURE	ESTIMATED QUANTITY	UNIT PRICE (IN FIGURES)	ITEM TOTAL (IN FIGURES)
1	070030	Lead Compliance Plan	LS	1		
2	072007A	Excavation Safety	LS	1		
3	080050	Progress Schedule (Critical Path Method)	LS	1		
4	120090	Construction Area Signs	LS	1		
5	120100	Traffic Control System	LS	1		
6	120159A	Temporary Pavement Delineation (Paint)	LS	1		
7	128601A	Portable Temporary Signal System	LS	1		
8	128652	Portable Changeable Message Sign	LS	1		
9	129000	Temporary Railing (Type K)	LF	560		
10	129110A	Temporary Crash Cushion (Absorb 350)	EA	2		
11	130100	Job Site Management	LS	1		
12	130300	Prepare Storm Water Pollution Prevention Plan	LS	1		
13	130310	Rain Event Action Plan	EA	5	\$500	\$2,500
14	130320	Storm Water Sampling and Analysis Day	EA	5	\$500	\$2,500

15	130330		Storm Water Annual Report	EA	1	\$2,500	\$2,500
16	130580A		Temporary Diversion	LS	1		
17	130680A		Temporary Orange Silt Fence	LF	260		
18	149001A		Prepare Fugitive Dust Control Plan	LS	1		
19	160110		Temporary High-Visibility Fence	LF	1,100		
20	170103		Clearing & Grubbing	LS	1		
21	190101	F	Roadway Excavation	CY	2,900		
22	190185		Shoulder Backing	TON	60		
23	192003	F	Structure Excavation (Bridge)	CY	321		
24	193003	F	Structure Backfill (Bridge)	CY	194		
25	204008A		Willow Cuttings	EA	30		
26	210280		Rolled Erosion Control Product (Blanket)	SQFT	28,000		
27	210430		Hydroseed	SQFT	28,000		
28	260203		Class 2 Aggregate Base	CY	360		
29	390132		Hot Mix Asphalt (Type A, PG 64-16)	TON	370		
30	394074		Place Hot Mix Asphalt Dike (Type C)	LF	122		
31	394077		Place Hot Mix Asphalt Dike (Type F)	LF	43		
32	398200		Cold Plane Asphalt Concrete Pavement	SQYD	125		
33	500001	P	Prestressing Cast-In-Place Concrete	LS	1		

34	510051	F	Structural Concrete, Bridge Footing	CY	58		
35	510053	F	Structural Concrete, Bridge	CY	224		
36	510054	F	Structural Concrete, Bridge (Polymer Fiber)	CY	82		
37	510085	F	Structural Concrete, Approach Slab (Type EQ)	CY	21		
38	510502A		Drainage Inlet	EA	1		
39	519088	P	Joint Seal (MR = 1", Type B)	LF	63		
40	520102	F P	Bar Reinforcing Steel (Bridge)	LB	38,400		
41	520110	F P	Bar Reinforcing Steel (Bridge, Epoxy Coated)	LB	28,200		
42	520120		Headed Bar Reinforcement	EA	24		
43	590229A		Staining Galvanized Surfaces	LS	1		
44	600097		Bridge Removal	LS	1		
45	641107		18" Plastic Pipe	LF	75		
46	691900		Flume Downdrain	LF	32		
47	692001		Entrance Taper	EA	1		
48	705011		18" Steel Flared End Section	EA	3		
49	710136		Remove Pipe	LF	61		
50	723055		Rock Slope Protection (1/4 T, Class V, Method B)	TON	1,230		
51	723075		Rock Slope Protection (150 lb, Class III, Method B)	TON	39		
52	723085		Rock Slope Protection (60 lb, Class II, Method B)	TON	465		

53	729011		Rock Slope Protection Fabric (Class 8)	SQYD	1,600		
54	731504		Minor Concrete (Curb and Gutter)	CY	14		
55	800051		Fence (Type WM, Metal Post)	LF	670		
56	800102		Temporary Fence (Type WM)	LF	220		
57	803190		Relocate Gate	EA	1		
58	810170A		Delineator (Class 1 or Class 2, Type E)	EA	18		
59	820112		Marker (Culvert)	EA	3		
60	820410		Salvage Roadside Sign	EA	6		
61	820610		Relocate Roadside Sign	EA	1		
62	820840		Roadside Sign - One Post	EA	2		
63	832007		Midwest Guardrail System (Wood Post)	LF	113		
64	839540		Transition Railing (Type STB)	EA	1		
65	839543		Transition Railing (Type WB-31)	EA	3		
66	839585A		MGS Flared Terminal System	EA	5		
67	839714A	F	Concrete Barrier (Type 80 Modified)	LF	267		
68	840502		Thermoplastic Traffic Stripe (Enhanced Wet Night Visibility)	LF	1,276		
69	999990		Mobilization	LS	1		
<b>Total Bid:</b>							

(F) Final Pay Quantity  
(P) Eligible for Partial Payment  
(LS) Lump Sum

Bassi Road at Granite Creek Bridge Replacement  
**CIP No. 77128, Contract No. 2777**  
January 29, 2019

County of El Dorado  
**Agreement**  
C-14 REV

**PROPOSAL PAY ITEMS AND BID PRICE SCHEDULE  
BASSI ROAD AT GRANITE CREEK BRIDGE REPLACEMENT  
CIP No. 77128, CONTRACT No. 2777**

ITEM NO.	ITEM CODE	ITEM DESCRIPTION	UNIT OF MEASURE	ESTIMATED QUANTITY	UNIT PRICE (IN FIGURES)	ITEM TOTAL (IN FIGURES)
1	070030	Lead Compliance Plan	LS	1		
2	072007A	Excavation Safety	LS	1		
3	080050	Progress Schedule (Critical Path Method)	LS	1		
4	120090	Construction Area Signs	LS	1		
5	120100	Traffic Control System	LS	1		
6	120159A	Temporary Pavement Delineation (Paint)	LS	1		
7	128601A	Portable Temporary Signal System	LS	1		
8	128652	Portable Changeable Message Sign	LS	1		
9	129000	Temporary Railing (Type K)	LF	560		
10	129110A	Temporary Crash Cushion (Absorb 350)	EA	2		
11	130100	Job Site Management	LS	1		
12	130300	Prepare Storm Water Pollution Prevention Plan	LS	1		
13	130310	Rain Event Action Plan	EA	5	\$500	\$2,500
14	130320	Storm Water Sampling and Analysis Day	EA	5	\$500	\$2,500
15	130330	Storm Water Annual Report	EA	1	\$2,500	\$2,500
16	130580A	Temporary Diversion	LS	1		
17	130680A	Temporary Orange Silt Fence	LF	260		

18	149001A		Prepare Fugitive Dust Control Plan	LS	1		
19	160110		Temporary High-Visibility Fence	LF	1,100		
20	170103		Clearing & Grubbing	LS	1		
21	190101	F	Roadway Excavation	CY	2,900		
22	190185		Shoulder Backing	TON	60		
23	192003	F	Structure Excavation (Bridge)	CY	321		
24	193003	F	Structure Backfill (Bridge)	CY	194		
25	204008A		Willow Cuttings	EA	30		
26	210280		Rolled Erosion Control Product (Blanket)	SQFT	28,000		
27	210430		Hydroseed	SQFT	28,000		
28	260203		Class 2 Aggregate Base	CY	360		
29	390132		Hot Mix Asphalt (Type A, PG 64-16)	TON	370		
30	394074		Place Hot Mix Asphalt Dike (Type C)	LF	122		
31	394077		Place Hot Mix Asphalt Dike (Type F)	LF	43		
32	398200		Cold Plane Asphalt Concrete Pavement	SQYD	125		
33	500001	P	Prestressing Cast-In-Place Concrete	LS	1		
34	510051	F	Structural Concrete, Bridge Footing	CY	58		
35	510053	F	Structural Concrete, Bridge	CY	224		
36	510054	F	Structural Concrete, Bridge (Polymer Fiber)	CY	82		
37	510085	F	Structural Concrete, Approach Slab (Type EQ)	CY	21		



38	510502A		Drainage Inlet	EA	1		
39	519088	P	Joint Seal (MR = 1", Type B)	LF	63		
40	520102	F P	Bar Reinforcing Steel (Bridge)	LB	38,400		
41	520110	F P	Bar Reinforcing Steel (Bridge, Epoxy Coated)	LB	28,200		
42	520120		Headed Bar Reinforcement	EA	24		
43	590229A		Staining Galvanized Surfaces	LS	1		
44	600097		Bridge Removal	LS	1		
45	641107		18" Plastic Pipe	LF	75		
46	691900		Flume Downdrain	LF	32		
47	692001		Entrance Taper	EA	1		
48	705011		18" Steel Flared End Section	EA	3		
49	710136		Remove Pipe	LF	61		
50	723055		Rock Slope Protection (1/4 T, Class V, Method B)	TON	1,230		
51	723075		Rock Slope Protection (150 lb, Class III, Method B)	TON	39		
52	723085		Rock Slope Protection (60 lb, Class II, Method B)	TON	465		
53	729011		Rock Slope Protection Fabric (Class 8)	SQYD	1,600		
54	731504		Minor Concrete (Curb and Gutter)	CY	14		
55	800051		Fence (Type WM, Metal Post)	LF	670		
56	800102		Temporary Fence (Type WM)	LF	220		
57	803190		Relocate Gate	EA	1		

58	810170A		Delineator (Class 1 or Class 2, Type E)	EA	18		
59	820112		Marker (Culvert)	EA	3		
60	820410		Salvage Roadside Sign	EA	6		
61	820610		Relocate Roadside Sign	EA	1		
62	820840		Roadside Sign - One Post	EA	2		
63	832007		Midwest Guardrail System (Wood Post)	LF	113		
64	839540		Transition Railing (Type STB)	EA	1		
65	839543		Transition Railing (Type WB-31)	EA	3		
66	839585A		MGS Flared Terminal System	EA	5		
67	839714A	F	Concrete Barrier (Type 80 Modified)	LF	267		
68	840502		Thermoplastic Traffic Stripe (Enhanced Wet Night Visibility)	LF	1,276		
69	999990		Mobilization	LS	1		
<b>Total Bid:</b>							

(F) Final Pay Quantity  
(P) Eligible for Partial Payment  
(LS) Lump Sum

**(NOTICE: Bidders failure to execute the questionnaires and statements contained in this proposal as required by applicable laws and regulations, or the determinations by County of El Dorado based upon those questionnaires and statements, may prohibit award of the subject Contract to the bidder.)**

**EXHIBIT E**

**FEDERAL WAGE RATES**

General Decision Number: CA190007 02/15/2019 CA7

Superseded General Decision Number: CA20180009

State: California

Construction Types: Building, Heavy (Heavy and Dredging) and Highway

Counties: Alpine, Amador, Butte, Colusa, El Dorado, Glenn, Lassen, Marin, Modoc, Napa, Nevada, Placer, Plumas, Sacramento, Shasta, Sierra, Siskiyou, Solano, Sonoma, Sutter, Tehama, Trinity, Yolo and Yuba Counties in California.

BUILDING CONSTRUCTION PROJECTS (excluding Amador County only); DREDGING CONSTRUCTION PROJECTS (does not include hopper dredge work); HEAVY CONSTRUCTION PROJECTS (does not include water well drilling); AND HIGHWAY CONSTRUCTION PROJECTS

Note: Under Executive Order (EO) 13658, an hourly minimum wage of \$10.60 for calendar year 2019 applies to all contracts subject to the Davis-Bacon Act for which the contract is awarded (and any solicitation was issued) on or after January 1, 2015. If this contract is covered by the EO, the contractor must pay all workers in any classification listed on this wage determination at least \$10.60 per hour (or the applicable wage rate listed on this wage determination, if it is higher) for all hours spent performing on the contract in calendar year 2019. If this contract is covered by the EO and a classification considered necessary for performance of work on the contract does not appear on this wage determination, the contractor must pay workers in that classification at least the wage rate determined through the conformance process set forth in 29 CFR 5.5(a)(1)(ii) (or the EO minimum wage rate, if it is higher than the conformed wage rate). The EO minimum wage rate will be adjusted annually. Please note that this EO applies to the above-mentioned types of contracts entered into by the federal government that are subject to the Davis-Bacon Act itself, but it does not apply to contracts subject only to the Davis-Bacon Related Acts, including those set forth at 29 CFR 5.1(a)(2)-(60). Additional information on contractor requirements and worker protections under the EO is available at [www.dol.gov/whd/govcontracts](http://www.dol.gov/whd/govcontracts).

Modification Number	Publication Date
0	01/04/2019
1	02/01/2019
2	02/15/2019

ASBE0016-001 08/01/2018

AREA 1: MARIN, NAPA, SAN BENITO, SAN FRANCISCO, SOLANO, &

Bassi Road at Granite Creek Bridge Replacement  
**CIP No. 77128, Contract No. 2777**  
January 29, 2019

County of El Dorado  
**Agreement**  
C-34 REV

SONOMA COUNTIES

AREA 2: ALPINE, AMADOR, BUTTE, COLUSA, EL DORADO, GLENN, MODOC, NEVADA, PLACER, PLUMAS, SACRAMENTO, SHASTA, SIERRA, SISKIYOU, SUTTER, TEHEMA, TRINITY, YOLO, & YUBA COUNTIES

	Rates	Fringes
Asbestos Workers/Insulator (Includes the application of all insulating materials, Protective Coverings, Coatings, and Finishes to all types of mechanical systems)		
Area 1.....	\$ 68.11	23.28
Area 2.....	\$ 51.71	23.28

-----  
ASBE0016-007 06/25/2018

AREA 1 : ALPINE, AMADOR, BUTTE, COLUSA, EL DORADO, GLENN, LASSEN, MODOC, NEVADA, PLACER, PLUMAS, SACRAMENTO, SHASTA, SIERRA, SISKIYOU, SOLANO, SONOMA, SUTTER, TEHAMA, TRINITY, YOLO & YUBA COUNTIES

AREA 2: MARIN & NAPA COUNTIES

	Rates	Fringes
Asbestos Removal worker/hazardous material handler (Includes preparation, wetting, stripping, removal, scrapping, vacuuming, bagging and disposing of all insulation materials from mechanical systems, whether they contain asbestos or not)		
AREA 1.....	\$ 30.81	22.71
AREA 2.....	\$ 31.81	22.71

-----  
BOIL0549-002 10/01/2016

	Rates	Fringes
BOILERMAKER		
(1) Marin & Solano Counties.....	\$ 43.28	37.91
(2) Remaining Counties.....	\$ 39.68	35.71

-----  
BRCA0003-001 08/01/2017

	Rates	Fringes
MARBLE FINISHER.....	\$ 32.60	15.31

-----  
BRCA0003-004 05/01/2017

AREA 1: ALPINE, AMADOR, BUTTE, COLUSA, EL DORADO, GLENN,

LASSEN, MODOC, NEVADA, PLACER, PLUMAS, SACRAMENTO, SHASTA,  
SIERRA, SUTTER, TEHAMA, YOLO AND YUBA COUNTIES

AREA 2: MARIN, NAPA, SISKIYOU, SOLANO, SONOMA AND TRINITY  
COUNTIES

	Rates	Fringes
BRICKLAYER		
AREA 1.....	\$ 39.66	20.76
AREA 2.....	\$ 42.34	25.83

SPECIALTY PAY:

(A) Underground work such as tunnel work, sewer work, manholes, catch basins, sewer pipes and telephone conduit shall be paid \$1.25 per hour above the regular rate. Work in direct contact with raw sewage shall receive \$1.25 per hour in addition to the above.

(B) Operating a saw or grinder shall receive \$1.25 per hour above the regular rate.

(C) Guniting person shall receive \$1.25 per hour above the regular rate.

-----  
BRCA0003-008 09/01/2017

	Rates	Fringes
TERRAZZO FINISHER.....	\$ 35.14	16.87
TERRAZZO WORKER/SETTER.....	\$ 44.11	26.36

-----  
BRCA0003-010 04/01/2018

	Rates	Fringes
TILE FINISHER		
Area 1.....	\$ 26.04	13.75
Area 2.....	\$ 26.36	15.97
Area 3.....	\$ 28.56	15.87
Area 4.....	\$ 26.69	15.31
Tile Layer		
Area 1.....	\$ 43.36	16.79
Area 2.....	\$ 43.02	18.19
Area 3.....	\$ 47.77	18.29
Area 4.....	\$ 44.64	18.21

AREA 1: Butte, Colusa, El Dorado, Glenn, Lassen, Modoc, Nevada, Placer, Plumas, Sacramento, Shasta, Sierra, Sutter, Tehama, Yolo, Yuba

AREA 2: Alpine, Amador

AREA 3: Marin, Napa, Solano, Siskiyou

AREA 4: Sonoma

-----  
BRCA0003-014 08/01/2017

	Rates	Fringes
MARBLE MASON.....	\$ 44.60	26.83

-----  
CARP0034-001 07/01/2018

	Rates	Fringes
Diver		
Assistant Tender, ROV		
Tender/Technician.....	\$ 47.65	32.52
Diver standby.....	\$ 52.61	32.52
Diver Tender.....	\$ 51.82	32.52
Diver wet.....	\$ 97.17	32.52
Manifold Operator (mixed gas).....	\$ 56.82	32.52
Manifold Operator (Standby).....	\$ 51.82	32.52

DEPTH PAY (Surface Diving):  
050 to 100 ft \$2.00 per foot  
101 to 150 ft \$3.00 per foot  
151 to 220 ft \$4.00 per foot

SATURATION DIVING:

The standby rate shall apply until saturation starts. The saturation diving rate applies when divers are under pressure continuously until work task and decompression are complete. The diver rate shall be paid for all saturation hours.

DIVING IN ENCLOSURES:

Where it is necessary for Divers to enter pipes or tunnels, or other enclosures where there is no vertical ascent, the following premium shall be paid: Distance traveled from entrance 26 feet to 300 feet: \$1.00 per foot. When it is necessary for a diver to enter any pipe, tunnel or other enclosure less than 48" in height, the premium will be \$1.00 per foot.

WORK IN COMBINATION OF CLASSIFICATIONS:

Employees working in any combination of classifications within the diving crew (except dive supervisor) in a shift are paid in the classification with the highest rate for that shift.

-----  
CARP0034-003 07/01/2017

	Rates	Fringes
Piledriver.....	\$ 46.65	31.91

-----  
CARP0035-001 08/01/2018

AREA 1: MARIN, NAPA, SOLANO & SONOMA

AREA 3: SACRAMENTO, WESTERN EL DORADO (Territory west of an including highway 49 and the territory inside the city limits of Placerville), WESTERN PLACER (Territory west of and including highway 49), & YOLO

AREA 4: ALPINE, BUTTE, COLUSA, EASTERN EL DORADO, GLENN, LASSEN, MODOC, NEVADA, EASTERN PLACER, PLUMAS, SHASTA, SIERRA,

SISKIYOU, SUTTER, TEHAMA, TRINITY, & YUBA

	Rates	Fringes
Drywall Installers/Lathers:		
Area 1.....	\$ 48.40	29.76
Area 3.....	\$ 43.02	29.76
Area 4.....	\$ 41.67	29.76
Drywall Stocker/Scrapper		
Area 1.....	\$ 24.20	17.29
Area 3.....	\$ 21.51	17.51
Area 4.....	\$ 20.84	17.29

-----  
 CARP0035-009 07/01/2018

Marin County

	Rates	Fringes
CARPENTER		
Bridge Builder/Highway Carpenter.....	\$ 48.40	29.32
Hardwood Floorlayer, Shingler, Power Saw Operator, Steel Scaffold & Steel Shoring Erector, Saw Filer.....	\$ 48.55	29.32
Journeyman Carpenter.....	\$ 48.40	29.32
Millwright.....	\$ 48.50	30.91

-----  
 CARP0035-010 07/01/2017

AREA 1: Marin, Napa, Solano & Sonoma Counties

AREA 2: Monterey, San Benito and Santa Cruz

AREA 3: Alpine, Butte, Colusa, El Dorado, Glenn, Lassen, Modoc,  
 Nevada, Placer, Plumas, Sacramento, Shasta, Sierra, Siskiyou,  
 Sutter, Tehama, Trinity, Yolo & Yuba counties

	Rates	Fringes
Modular Furniture Installer		
Area 1		
Installer I.....	\$ 24.91	19.63
Installer II.....	\$ 22.18	20.42
Lead Installer.....	\$ 29.06	20.92
Master Installer.....	\$ 33.28	20.92
Area 2		
Installer I.....	\$ 22.96	20.42
Installer II.....	\$ 20.01	20.42
Lead Installer.....	\$ 25.93	20.92
Master Installer.....	\$ 29.56	20.92
Area 3		
Installer I.....	\$ 22.01	20.42
Installer II.....	\$ 19.24	20.42
Lead Installer.....	\$ 24.81	20.92
Master Installer.....	\$ 31.83	20.92

-----  
CARP0046-001 07/01/2018

El Dorado (West), Placer (West), Sacramento and Yolo Counties

	Rates	Fringes
Carpenters		
Bridge Builder/Highway Carpenter.....	\$ 48.40	29.32
Hardwood Floorlayer, Shingler, Power Saw Operator, Steel Scaffold & Steel Shoring Erector, Saw Filer.....	\$ 42.67	29.32
Journeyman Carpenter.....	\$ 42.52	29.32
Millwright.....	\$ 45.02	30.91

Footnote: Placer County (West) includes territory West of and including Highway 49 and El Dorado County (West) includes territory West of and including Highway 49 and territory inside the city limits of Placerville.

-----  
CARP0046-002 07/01/2018

Alpine, Colusa, El Dorado (East), Nevada, Placer (East),  
Sierra, Sutter and Yuba Counties

	Rates	Fringes
Carpenters		
Bridge Builder/Highway Carpenter.....	\$ 48.40	29.32
Hardwood Floorlayer, Shingler, Power Saw Operator, Steel Scaffold & Steel Shoring Erector, Saw Filer.....	\$ 41.32	29.32
Journeyman Carpenter.....	\$ 40.17	29.32
Millwright.....	\$ 43.67	30.91

-----  
CARP0152-003 07/01/2018

Amador County

	Rates	Fringes
Carpenters		
Bridge Builder/Highway Carpenter.....	\$ 48.40	29.32
Hardwood Floorlayer, Shingler, Power Saw Operator, Steel Scaffold & Steel Shoring Erector, Saw Filer.....	\$ 41.32	29.32
Journeyman Carpenter.....	\$ 41.17	29.32
Millwright.....	\$ 43.67	30.91



CARP0180-001 07/01/2018

Solano County

	Rates	Fringes
Carpenters		
Bridge Builder/Highway Carpenter.....	\$ 48.40	29.32
Hardwood Floorlayer, Shingler, Power Saw Operator, Steel Scaffold & Steel Shoring Erector, Saw Filer.....	\$ 48.55	29.32
Journeyman Carpenter.....	\$ 48.40	29.32
Millwright.....	\$ 48.50	30.91

CARP0751-001 07/01/2018

Napa and Sonoma Counties

	Rates	Fringes
Carpenters		
Bridge Builder/Highway Carpenter.....	\$ 48.40	29.32
Hardwood Floorlayer, Shingler, Power Saw Operator, Steel Scaffold & Steel Shoring Erector, Saw Filer.....	\$ 48.55	29.32
Journeyman Carpenter.....	\$ 48.50	29.32
Millwright.....	\$ 48.50	30.91

CARP1599-001 07/01/2018

Butte, Glenn, Lassen, Modoc, Plumas, Shasta, Siskiyou, Tehama  
and Trinity Counties

	Rates	Fringes
Carpenters		
Bridge Builder/Highway Carpenter.....	\$ 48.40	29.32
Hardwood Floorlayer, Shingler, Power Saw Operator, Steel Scaffold & Steel Shoring Erector, Saw Filer.....	\$ 41.32	29.32
Journeyman Carpenter.....	\$ 41.17	29.32
Millwright.....	\$ 43.67	30.91

ELEC0180-001 06/01/2017

NAPA AND SOLANO COUNTIES

	Rates	Fringes
CABLE SPLICER.....	\$ 50.97	3%+20.13

ELECTRICIAN.....\$ 47.31 23.05

-----  
ELEC0180-003 12/01/2018

NAPA AND SOLANO COUNTIES

	Rates	Fringes
Sound & Communications		
Installer.....	\$ 38.42	20.20
Technician.....	\$ 44.18	20.20

SCOPE OF WORK INCLUDES-

SOUND & VOICE TRANSMISSION (Music, Intercom, Nurse Call, Telephone); FIRE ALARM SYSTEMS [excluding fire alarm work when installed in raceways (including wire and cable pulling) and when performed on new or major remodel building projects or jobs], TELEVISION & VIDEO SYSTEMS, SECURITY SYSTEMS, COMMUNICATIONS SYSTEMS that transmit or receive information and/or control systems that are intrinsic to the above.

EXCLUDES-

Excludes all other data systems or multiple systems which include control function or power supply; excludes installation of raceway systems, line voltage work, industrial work, life-safety systems (all buildings having floors located more than 75' above the lowest floor level having building access); excludes energy management systems.

-----  
ELEC0340-002 02/01/2018

ALPINE, AMADOR, BUTTE, COLUSA, EL DORADO, GLENN, LASSEN, NEVADA, PLACER, PLUMAS, SACRAMENTO, TRINITY, YOLO, YUBA COUNTIES

	Rates	Fringes
Communications System		
Sound & Communications		
Installer.....	\$ 29.35	3%+15.35
Sound & Communications		
Technician.....	\$ 33.75	3%+15.35

SCOPE OF WORK

Includes the installation testing, service and maintenance, of the following systems which utilize the transmission and/or transference of voice, sound, vision and digital for commercial, education, security and entertainment purposes for the following TV monitoring and surveillance, background-foreground music, intercom and telephone interconnect, inventory control systems, microwave transmission, multi-media, multiplex, nurse call system, radio page, school intercom and sound, burglar alarms, and low voltage master clock systems.

A. SOUND AND VOICE TRANSMISSION/TRANSFERENCE SYSTEMS

Background foreground music Intercom and telephone interconnect systems, Telephone systems, Nurse call systems, Radio page systems, School intercom and sound systems, Burglar alarm systems, Low voltage master clock systems, Multi-media/multiplex systems, Sound and musical entertainment systems, RF systems, Antennas and Wave Guide.

B. FIRE ALARM SYSTEMS

Installation, wire pulling and testing

C. TELEVISION AND VIDEO SYSTEMS      Television monitoring and surveillance systems, Video security systems, Video entertainment systems, Video educational systems, Microwave transmission systems, CATV and CCTV

D. SECURITY SYSTEMS      Perimeter security systems  
Vibration sensor systems      Card access systems      Access control systems      Sonar/infrared monitoring equipment

E. COMMUNICATIONS SYSTEMS THAT TRANSMIT OR RECEIVE INFORMATION AND/OR CONTROL SYSTEMS THAT ARE INTRINSIC TO THE ABOVE LISTED SYSTEMS      SCADA (Supervisory Control and Data Acquisition)      PCM (Pulse Code Modulation)  
Inventory Control Systems      Digital Data Systems  
Broadband and Baseband and Carriers      Point of Sale Systems      VSAT Data Systems      Data Communication Systems      RF and Remote Control Systems      Fiber Optic Data Systems

WORK EXCLUDED Raceway systems are not covered (excluding Ladder-Rack for the purpose of the above listed systems). Chases and/or nipples (not to exceed 10 feet) may be installed on open wiring systems. Energy management systems. SCADA (Supervisory Control and Data Acquisition) when not intrinsic to the above listed systems (in the scope). Fire alarm systems when installed in raceways (including wire and cable pulling) shall be performed at the electrician wage rate, when either of the following two (2) conditions apply:

1. The project involves new or major remodel building trades construction.
2. The conductors for the fire alarm system are installed in conduit.

-----  
ELEC0340-003 08/01/2018

ALPINE (West of Sierra Mt. Watershed), AMADOR, BUTTE, COLUSA, EL DORADO (West of Sierra Mt. Watershed), GLENN, LASSEN, NEVADA (West of Sierra Mt. Watershed), PLACER, PLUMAS, SACRAMENTO, SHASTA, SIERRA (West of Sierra Mt. Watershed), SUTTER, TEHAMA, TRINITY, YOLO & YUBA COUNTIES

	Rates	Fringes
ELECTRICIAN		
Remaining area.....	\$ 40.06	28.54
Sierra Army Depot, Herlong..	\$ 48.83	18.54
Tunnel work.....	\$ 41.01	18.54

CABLE SPLICER:    Receives 110% of the Electrician basic hourly

rate.

-----  
ELEC0401-005 07/01/2018

ALPINE (east of the main watershed divide), EL DORADO (east of the main watershed divide), NEVADA (east of the main watershed), PLACER (east of the main watershed divide) and SIERRA (east of the main watershed divide) COUNTIES:

	Rates	Fringes
ELECTRICIAN.....	\$ 40.50	17.38

-----  
ELEC0551-004 06/01/2018

MARIN AND SONOMA COUNTIES

	Rates	Fringes
ELECTRICIAN.....	\$ 48.40	22.66

-----  
ELEC0551-005 12/01/2018

MARIN & SONOMA COUNTIES

	Rates	Fringes
Sound & Communications		
Installer.....	\$ 38.42	20.11
Technician.....	\$ 44.18	20.29

SCOPE OF WORK INCLUDES-

SOUND & VOICE TRANSMISSION (Music, Intercom, Nurse Call, Telephone); FIRE ALARM SYSTEMS [excluding fire alarm work when installed in raceways (including wire and cable pulling) and when performed on new or major remodel building projects or jobs], TELEVISION & VIDEO SYSTEMS, SECURITY SYSTEMS, COMMUNICATIONS SYSTEMS that transmit or receive information and/or control systems that are intrinsic to the above.

EXCLUDES-

Excludes all other data systems or multiple systems which include control function or power supply; excludes installation of raceway systems, line voltage work, industrial work, life-safety systems (all buildings having floors located more than 75' above the lowest floor level having building access); excludes energy management systems.

-----  
ELEC0659-006 01/01/2018

DEL NORTE, MODOC and SISKIYOU COUNTIES

	Rates	Fringes
ELECTRICIAN.....	\$ 33.94	16.79

-----  
ELEC0659-008 02/01/2018

DEL NORTE, MODOC & SISKIYOU COUNTIES

	Rates	Fringes
Line Construction		
(1) Cable Splicer.....	\$ 57.94	18.27
(2) Lineman, Pole Sprayer, Heavy Line Equipment Man....	\$ 51.73	18.02
(3) Tree Trimmer.....	\$ 31.10	11.32
(4) Line Equipment Man.....	\$ 51.73	18.02
(5) Powdermen, Jackhammermen.....	\$ 33.80	13.35
(6) Groundman.....	\$ 33.11	13.17

-----  
\* ELEC1245-004 01/01/2019

ALL COUNTIES EXCEPT DEL NORTE, MODOC & SISKIYOU

	Rates	Fringes
LINE CONSTRUCTION		
(1) Lineman; Cable splicer..	\$ 56.79	17.41
(2) Equipment specialist (operates crawler tractors, commercial motor vehicles, backhoes, trenchers, cranes (50 tons and below), overhead & underground distribution line equipment).....	\$ 45.36	16.24
(3) Groundman.....	\$ 34.68	15.86
(4) Powderman.....	\$ 49.55	3%+17.65

HOLIDAYS: New Year's Day, M.L. King Day, Memorial Day,  
Independence Day, Labor Day, Veterans Day, Thanksgiving Day  
and day after Thanksgiving, Christmas Day

-----  
ELEV0008-001 01/01/2019

	Rates	Fringes
ELEVATOR MECHANIC.....	\$ 67.56	34.125+a+b

FOOTNOTE:

PAID VACATION: Employer contributes 8% of regular hourly  
rate as vacation pay credit for employees with more than 5  
years of service, and 6% for 6 months to 5 years of service.  
PAID HOLIDAYS: New Years Day, Memorial Day, Independence Day,  
Labor Day, Veterans Day, Thanksgiving Day, Friday after  
Thanksgiving, and Christmas Day.

-----  
ENGI0003-008 07/01/2017

	Rates	Fringes
--	-------	---------

Dredging: (DREDGING:  
 CLAMSHELL & DIPPER DREDGING;  
 HYDRAULIC SUCTION DREDGING:)

AREA 1:		
(1) Leverman.....	\$ 44.77	31.25
(2) Dredge Dozer; Heavy duty repairman.....	\$ 39.81	31.25
(3) Booster Pump Operator; Deck Engineer; Deck mate; Dredge Tender; Winch Operator.....	\$ 38.69	31.25
(4) Bargeman; Deckhand; Fireman; Leveehand; Oiler..	\$ 35.39	31.25
AREA 2:		
(1) Leverman.....	\$ 46.77	31.25
(2) Dredge Dozer; Heavy duty repairman.....	\$ 41.81	31.25
(3) Booster Pump Operator; Deck Engineer; Deck mate; Dredge Tender; Winch Operator.....	\$ 40.69	31.25
(4) Bargeman; Deckhand; Fireman; Leveehand; Oiler..	\$ 37.39	31.25

AREA DESCRIPTIONS

AREA 1: ALAMEDA, BUTTE, CONTRA COSTA, KINGS, MARIN, MERCED,  
 NAPA, SACRAMENTO, SAN BENITO, SAN FRANCISCO, SAN JOAQUIN,  
 SAN MATEO, SANTA CLARA, SANTA CRUZ, SOLANO, STANISLAUS,  
 SUTTER, YOLO, AND YUBA COUNTIES

AREA 2: MODOC COUNTY

THE REMAINING COUNTIES ARE SPLIT BETWEEN AREA 1 AND AREA 2  
 AS NOTED BELOW:

ALPINE COUNTY:

Area 1: Northernmost part  
 Area 2: Remainder

CALAVERAS COUNTY:

Area 1: Remainder  
 Area 2: Eastern part

COLUSA COUNTY:

Area 1: Eastern part  
 Area 2: Remainder

ELDORADO COUNTY:

Area 1: North Central part  
 Area 2: Remainder

FRESNO COUNTY:

Area 1: Remainder  
 Area 2: Eastern part

GLENN COUNTY:

Area 1: Eastern part

Area 2: Remainder

LASSEN COUNTY:

Area 1: Western part along the Southern portion of border  
with Shasta County

Area 2: Remainder

MADERA COUNTY:

Area 1: Except Eastern part

Area 2: Eastern part

MARIPOSA COUNTY

Area 1: Except Eastern part

Area 2: Eastern part

MONTERREY COUNTY

Area 1: Except Southwestern part

Area 2: Southwestern part

NEVADA COUNTY:

Area 1: All but the Northern portion along the border of  
Sierra County

Area 2: Remainder

PLACER COUNTY:

Area 1: Al but the Central portion

Area 2: Remainder

PLUMAS COUNTY:

Area 1: Western portion

Area 2: Remainder

SHASTA COUNTY:

Area 1: All but the Northeastern corner

Area 2: Remainder

SIERRA COUNTY:

Area 1: Western part

Area 2: Remainder

SISKIYOU COUNTY:

Area 1: Central part

Area 2: Remainder

SONOMA COUNTY:

Area 1: All but the Northwestern corner

Area 2: Remainder

TEHAMA COUNTY:

Area 1: All but the Western border with Mendocino & Trinity  
Counties

Area 2: Remainder

TRINITY COUNTY:

Area 1: East Central part and the Northeastern border with  
Shasta County

Area 2: Remainder

TUOLUMNE COUNTY:

Area 1: Except Eastern part

Area 2: Eastern part

-----  
 ENGI0003-018 06/26/2017

"AREA 1" WAGE RATES ARE LISTED BELOW

"AREA 2" RECEIVES AN ADDITIONAL \$2.00 PER HOUR ABOVE AREA 1 RATES.

SEE AREA DEFINITIONS BELOW

	Rates	Fringes
OPERATOR: Power Equipment		
(AREA 1:)		
GROUP 1.....	\$ 44.67	30.39
GROUP 2.....	\$ 43.14	30.39
GROUP 3.....	\$ 41.66	30.39
GROUP 4.....	\$ 40.28	30.39
GROUP 5.....	\$ 39.01	30.39
GROUP 6.....	\$ 37.69	30.39
GROUP 7.....	\$ 36.55	30.39
GROUP 8.....	\$ 35.41	30.39
GROUP 8-A.....	\$ 33.20	30.39
OPERATOR: Power Equipment		
(Cranes and Attachments -		
AREA 1:)		
GROUP 1		
Cranes.....	\$ 46.30	30.39
Oiler.....	\$ 36.63	30.39
Truck crane oiler.....	\$ 39.20	30.39
GROUP 2		
Cranes.....	\$ 43.79	30.39
Oiler.....	\$ 36.36	30.39
Truck crane oiler.....	\$ 38.98	30.39
GROUP 3		
Cranes.....	\$ 42.05	30.39
Hydraulic.....	\$ 38.32	30.39
Oiler.....	\$ 36.14	30.39
Truck Crane Oiler.....	\$ 38.71	30.39
GROUP 4		
Cranes.....	\$ 39.01	30.39
OPERATOR: Power Equipment		
(Piledriving - AREA 1:)		
GROUP 1		
Lifting devices.....	\$ 45.89	30.39
Oiler.....	\$ 36.63	30.39
Truck crane oiler.....	\$ 39.20	30.39
GROUP 2		
Lifting devices.....	\$ 44.07	30.39
Oiler.....	\$ 36.36	30.39
Truck Crane Oiler.....	\$ 38.98	30.39
GROUP 3		
Lifting devices.....	\$ 42.39	30.39
Oiler.....	\$ 36.14	30.39
Truck Crane Oiler.....	\$ 38.71	30.39
GROUP 4		
Lifting devices.....	\$ 40.62	30.39



GROUP 5		
Lifting devices.....	\$ 39.32	30.39
GROUP 6		
Lifting devices.....	\$ 37.98	30.39
OPERATOR: Power Equipment		
(Steel Erection - AREA 1:)		
GROUP 1		
Cranes.....	\$ 46.30	30.39
Oiler.....	\$ 36.63	30.39
Truck Crane Oiler.....	\$ 39.20	30.39
GROUP 2		
Cranes.....	\$ 43.79	30.39
Oiler.....	\$ 36.36	30.39
Truck Crane Oiler.....	\$ 38.98	30.39
GROUP 3		
Cranes.....	\$ 42.05	30.39
Hydraulic.....	\$ 38.32	30.39
Oiler.....	\$ 36.14	30.39
Truck Crane Oiler.....	\$ 38.71	30.39
GROUP 4		
Cranes.....	\$ 39.01	30.39
GROUP 5		
Cranes.....	\$ 35.13	30.39
OPERATOR: Power Equipment		
(Tunnel and Underground Work		
- AREA 1:)		
SHAFTS, STOPES, RAISES:		
GROUP 1.....	\$ 40.77	30.39
GROUP 1-A.....	\$ 43.24	30.39
GROUP 2.....	\$ 39.51	30.39
GROUP 3.....	\$ 38.18	30.39
GROUP 4.....	\$ 37.04	30.39
GROUP 5.....	\$ 35.90	30.39
UNDERGROUND:		
GROUP 1.....	\$ 40.67	30.39
GROUP 1-A.....	\$ 43.14	30.39
GROUP 2.....	\$ 39.41	30.39
GROUP 3.....	\$ 38.08	30.39
GROUP 4.....	\$ 36.94	30.39
GROUP 5.....	\$ 35.80	30.39

FOOTNOTE: Work suspended by ropes or cables, or work on a Yo-Yo Cat: \$.60 per hour additional.

#### POWER EQUIPMENT OPERATOR CLASSIFICATIONS

GROUP 1: Operator of helicopter (when used in erection work); Hydraulic excavator, 7 cu. yds. and over; Power shovels, over 7 cu. yds.

GROUP 2: Highline cableway; Hydraulic excavator, 3-1/2 cu. yds. up to 7 cu. yds.; Licensed construction work boat operator, on site; Power blade operator (finish); Power shovels, over 1 cu. yd. up to and including 7 cu. yds. m.r.c.

GROUP 3: Asphalt milling machine; Cable backhoe; Combination backhoe and loader over 3/4 cu. yds.; Continuous flight tie back machine assistant to engineer or mechanic; Crane

mounted continuous flight tie back machine, tonnage to apply; Crane mounted drill attachment, tonnage to apply; Dozer, slope brd; Gradall; Hydraulic excavator, up to 3 1/2 cu. yds.; Loader 4 cu. yds. and over; Long reach excavator; Multiple engine scraper (when used as push pull); Power shovels, up to and including 1 cu. yd.; Pre-stress wire wrapping machine; Side boom cat, 572 or larger; Track loader 4 cu. yds. and over; Wheel excavator (up to and including 750 cu. yds. per hour)

GROUP 4: Asphalt plant engineer/box person; Chicago boom; Combination backhoe and loader up to and including 3/4 cu. yd.; Concrete batch plant (wet or dry); Dozer and/or push cat; Pull-type elevating loader; Gradesetter, grade checker (GPS, mechanical or otherwise); Grooving and grinding machine; Heading shield operator; Heavy-duty drilling equipment, Hughes, LDH, Watson 3000 or similar; Heavy-duty repairperson and/or welder; Lime spreader; Loader under 4 cu. yds.; Lubrication and service engineer (mobile and grease rack); Mechanical finishers or spreader machine (asphalt, Barber-Greene and similar); Miller Formless M-9000 slope paver or similar; Portable crushing and screening plants; Power blade support; Roller operator, asphalt; Rubber-tired scraper, self-loading (paddle-wheels, etc.); Rubber-tired earthmoving equipment (scrapers); Slip form paver (concrete); Small tractor with drag; Soil stabilizer (P & H or equal); Spider plow and spider puller; Tubex pile rig; Unlicensed construction work boat operator, on site; Timber skidder; Track loader up to 4 yds.; Tractor-drawn scraper; Tractor, compressor drill combination; Welder; Woods-Mixer (and other similar Pugmill equipment)

GROUP 5: Cast-in-place pipe laying machine; Combination slusher and motor operator; Concrete conveyor or concrete pump, truck or equipment mounted; Concrete conveyor, building site; Concrete pump or pumpcrete gun; Drilling equipment, Watson 2000, Texoma 700 or similar; Drilling and boring machinery, horizontal (not to apply to waterliners, wagon drills or jackhammers); Concrete mixer/all; Person and/or material hoist; Mechanical finishers (concrete) (Clary, Johnson, Bidwell Bridge Deck or similar types); Mechanical burm, curb and/or curb and gutter machine, concrete or asphalt); Mine or shaft hoist; Portable crusher; Power jumbo operator (setting slip-forms, etc., in tunnels); Screed (automatic or manual); Self-propelled compactor with dozer; Tractor with boom D6 or smaller; Trenching machine, maximum digging capacity over 5 ft. depth; Vermeer T-600B rock cutter or similar

GROUP 6: Armor-Coater (or similar); Ballast jack tamper; Boom-type backfilling machine; Assistant plant engineer; Bridge and/or gantry crane; Chemical grouting machine, truck-mounted; Chip spreading machine operator; Concrete saw (self-propelled unit on streets, highways, airports and canals); Deck engineer; Drilling equipment Texoma 600, Hughes 200 Series or similar up to and including 30 ft. m.r.c.; Drill doctor; Helicopter radio operator; Hydro-hammer or similar; Line master; Skidsteer loader, Bobcat larger than 743 series or similar (with

attachments); Locomotive; Lull hi-lift or similar; Oiler, truck mounted equipment; Pavement breaker, truck-mounted, with compressor combination; Paving fabric installation and/or laying machine; Pipe bending machine (pipelines only); Pipe wrapping machine (tractor propelled and supported); Screed (except asphaltic concrete paving); Self-propelled pipeline wrapping machine; Tractor; Self-loading chipper; Concrete barrier moving machine

GROUP 7: Ballast regulator; Boom truck or dual-purpose A-frame truck, non-rotating - under 15 tons; Cargy lift or similar; Combination slurry mixer and/or cleaner; Drilling equipment, 20 ft. and under m.r.c.; Firetender (hot plant); Grouting machine operator; Highline cableway signalperson; Stationary belt loader (Kolman or similar); Lift slab machine (Vagtborg and similar types); Maginnes internal full slab vibrator; Material hoist (1 drum); Mechanical trench shield; Pavement breaker with or without compressor combination); Pipe cleaning machine (tractor propelled and supported); Post driver; Roller (except asphalt); Chip Seal; Self-propelled automatically applied concrete curing machine (on streets, highways, airports and canals); Self-propelled compactor (without dozer); Signalperson; Slip-form pumps (lifting device for concrete forms); Tie spacer; Tower mobile; Trenching machine, maximum digging capacity up to and including 5 ft. depth; Truck-type loader

GROUP 8: Bit sharpener; Boiler tender; Box operator; Brakeperson; Combination mixer and compressor (shotcrete/gunite); Compressor operator; Deckhand; Fire tender; Forklift (under 20 ft.); Generator; Gunite/shotcrete equipment operator; Hydraulic monitor; Ken seal machine (or similar); Mixermobile; Oiler; Pump operator; Refrigeration plant; Reservoir-debris tug (self-propelled floating); Ross Carrier (construction site); Rotomist operator; Self-propelled tape machine; Shuttlecar; Self-propelled power sweeper operator (includes vacuum sweeper); Slusher operator; Surface heater; Switchperson; Tar pot firetender; Tugger hoist, single drum; Vacuum cooling plant; Welding machine (powered other than by electricity)

GROUP 8-A: Elevator operator; Skidsteer loader-Bobcat 743 series or smaller, and similar (without attachments); Mini excavator under 25 H.P. (backhoe-trencher); Tub grinder wood chipper

---

ALL CRANES AND ATTACHMENTS

GROUP 1: Clamshell and dragline over 7 cu. yds.; Crane, over 100 tons; Derrick, over 100 tons; Derrick barge pedestal-mounted, over 100 tons; Self-propelled boom-type lifting device, over 100 tons

GROUP 2: Clamshell and dragline over 1 cu. yd. up to and including 7 cu. yds.; Crane, over 45 tons up to and including 100 tons; Derrick barge, 100 tons and under; Self-propelled boom-type lifting device, over 45 tons;

Tower crane

GROUP 3: Clamshell and dragline up to and including 1 cu. yd.; Cranes 45 tons and under; Self-propelled boom-type lifting device 45 tons and under;

GROUP 4: Boom Truck or dual purpose A-frame truck, non-rotating over 15 tons; Truck-mounted rotating telescopic boom type lifting device, Manitex or similar (boom truck) over 15 tons; Truck-mounted rotating telescopic boom type lifting device, Manitex or similar (boom truck) - under 15 tons;

---

PILEDRIVERS

GROUP 1: Derrick barge pedestal mounted over 100 tons; Clamshell over 7 cu. yds.; Self-propelled boom-type lifting device over 100 tons; Truck crane or crawler, land or barge mounted over 100 tons

GROUP 2: Derrick barge pedestal mounted 45 tons to and including 100 tons; Clamshell up to and including 7 cu. yds.; Self-propelled boom-type lifting device over 45 tons; Truck crane or crawler, land or barge mounted, over 45 tons up to and including 100 tons; Fundex F-12 hydraulic pile rig

GROUP 3: Derrick barge pedestal mounted under 45 tons; Self-propelled boom-type lifting device 45 tons and under; Skid/scow piledriver, any tonnage; Truck crane or crawler, land or barge mounted 45 tons and under

GROUP 4: Assistant operator in lieu of assistant to engineer; Forklift, 10 tons and over; Heavy-duty repairperson/welder

GROUP 5: Deck engineer

GROUP 6: Deckhand; Fire tender

---

STEEL ERECTORS

GROUP 1: Crane over 100 tons; Derrick over 100 tons; Self-propelled boom-type lifting device over 100 tons

GROUP 2: Crane over 45 tons to 100 tons; Derrick under 100 tons; Self-propelled boom-type lifting device over 45 tons to 100 tons; Tower crane

GROUP 3: Crane, 45 tons and under; Self-propelled boom-type lifting device, 45 tons and under

GROUP 4: Chicago boom; Forklift, 10 tons and over; Heavy-duty repair person/welder

GROUP 5: Boom cat

--

TUNNEL AND UNDERGROUND WORK

GROUP 1-A: Tunnel bore machine operator, 20' diameter or more

GROUP 1: Heading shield operator; Heavy-duty repairperson; Mucking machine (rubber tired, rail or track type); Raised bore operator (tunnels); Tunnel mole bore operator

GROUP 2: Combination slusher and motor operator; Concrete pump or pumpcrete gun; Power jumbo operator

GROUP 3: Drill doctor; Mine or shaft hoist

GROUP 4: Combination slurry mixer cleaner; Grouting Machine operator; Motorman

GROUP 5: Bit Sharpener; Brakeman; Combination mixer and compressor (gunitite); Compressor operator; Oiler; Pump operator; Slusher operator

-----  
AREA DESCRIPTIONS:

POWER EQUIPMENT OPERATORS, CRANES AND ATTACHMENTS, TUNNEL AND UNDERGROUND [These areas do not apply to Piledrivers and Steel Erectors]

AREA 1: ALPINE, AMADOR, BUTTE, COLUSA, EL DORADO, GLENN, LASSEN, MARIN, NAPA, NEVADA, PLACER, PLUMAS, SACRAMENTO, SHASTA, SIERRA, SISKIYOU, SOLANO, SONOMA, SUTTER, TEHAMA, TRINITY, YOLO, YUBA

AREA 2 - MODOC COUNTY

THE REMAINING COUNTIES ARE SPLIT BETWEEN AREA 1 AND AREA 2 AS NOTED BELOW:

ALPINE COUNTY:

Area 1: Northernmost part

Area 2: Remainder

COLUSA COUNTY:

Area 1: Eastern part

Area 2: Remainder

DEL NORTE COUNTY:

Area 1: Extreme Southwestern corner

Area 2: Remainder

ELDORADO COUNTY:

Area 1: North Central part

Area 2: Remainder

GLENN COUNTY:

Area 1: Eastern part

Area 2: Remainder

LASSEN COUNTY:

Area 1: Western part along the Southern portion of border with Shasta County

Area 2: Remainder

NEVADA COUNTY:

Area 1: All but the Northern portion along the border of Sierra County

Area 2: Remainder

PLACER COUNTY:

Area 1: All but the Central portion

Area 2: Remainder

PLUMAS COUNTY:

Area 1: Western portion

Area 2: Remainder

SHASTA COUNTY:

Area 1: All but the Northeastern corner

Area 2: Remainder

SIERRA COUNTY:

Area 1: Western part

Area 2: Remainder

SISKIYOU COUNTY:

Area 1: Central part

Area 2: Remainder

SONOMA COUNTY:

Area 1: All but the Northwestern corner

Area 2: Reaminder

TEHAMA COUNTY:

Area 1: All but the Western border with mendocino & Trinity Counties

Area 2: Remainder

TRINITY COUNTY:

Area 1: East Central part and the Northeaster border with Shasta County

Area 2: Remainder

-----  
ENGI0003-019 07/26/2017

SEE AREA DESCRIPTIONS BELOW

	Rates	Fringes
OPERATOR: Power Equipment		
(LANDSCAPE WORK ONLY)		
GROUP 1		
AREA 1.....	\$ 34.05	28.73
AREA 2.....	\$ 36.05	28.73
GROUP 2		
AREA 1.....	\$ 30.45	28.73
AREA 2.....	\$ 32.45	28.73
GROUP 3		
AREA 1.....	\$ 25.84	28.73

GROUP DESCRIPTIONS:

GROUP 1: Landscape Finish Grade Operator: All finish grade work regardless of equipment used, and all equipment with a rating more than 65 HP.

GROUP 2: Landscape Operator up to 65 HP: All equipment with a manufacturer's rating of 65 HP or less except equipment covered by Group 1 or Group 3. The following equipment shall be included except when used for finish work as long as manufacturer's rating is 65 HP or less: A-Frame and Winch Truck, Backhoe, Forklift, Hydragraphic Seeder Machine, Roller, Rubber-Tired and Track Earthmoving Equipment, Skiploader, Straw Blowers, and Trencher 31 HP up to 65 HP.

GROUP 3: Landscae Utility Operator: Small Rubber-Tired Tractor, Trencher Under 31 HP.

AREA DESCRIPTIONS:

AREA 1: ALAMEDA, BUTTE, CONTRA COSTA, KINGS, MARIN, MERCED, NAPA, SACRAMENTO, SAN BENITO, SAN FRANCISCO, SAN JOAQUIN, SAN MATEO, SANTA CLARA, SANTA CRUZ, SOLANO, STANISLAUS, SUTTER, YOLO, AND YUBA COUNTIES

AREA 2 - MODOC COUNTY

THE REMAINING COUNTIES ARE SPLIT BETWEEN AREA 1 AND AREA 2 AS NOTED BELOW:

ALPINE COUNTY:

Area 1: Northernmost part
Area 2: Remainder

CALAVERAS COUNTY:

Area 1: Except Eastern part
Area 2: Eastern part

COLUSA COUNTY:

Area 1: Eastern part
Area 2: Remainder

DEL NORTE COUNTY:

Area 1: Extreme Southwestern corner
Area 2: Remainder

ELDORADO COUNTY:

Area 1: North Central part
Area 2: Remainder

FRESNO COUNTY

Area 1: Except Eastern part
Area 2: Eastern part

GLENN COUNTY:

Area 1: Eastern part
Area 2: Remainder

HUMBOLDT COUNTY:

Area 1: Except Eastern and Southwestern parts

Area 2: Remainder

LAKE COUNTY:

Area 1: Southern part

Area 2: Remainder

LASSEN COUNTY:

Area 1: Western part along the Southern portion of border  
with Shasta County

Area 2: Remainder

MADERA COUNTY

Area 1: Remainder

Area 2: Eastern part

MARIPOSA COUNTY

Area 1: Remainder

Area 2: Eastern part

MENDOCINO COUNTY:

Area 1: Central and Southeastern parts

Area 2: Remainder

MONTEREY COUNTY

Area 1: Remainder

Area 2: Southwestern part

NEVADA COUNTY:

Area 1: All but the Northern portion along the border of  
Sierra County

Area 2: Remainder

PLACER COUNTY:

Area 1: All but the Central portion

Area 2: Remainder

PLUMAS COUNTY:

Area 1: Western portion

Area 2: Remainder

SHASTA COUNTY:

Area 1: All but the Northeastern corner

Area 2: Remainder

SIERRA COUNTY:

Area 1: Western part

Area 2: Remainder

SISKIYOU COUNTY:

Area 1: Central part

Area 2: Remainder

SONOMA COUNTY:

Area 1: All but the Northwestern corner

Area 2: Remainder

TEHAMA COUNTY:



Area 1: All but the Western border with mendocino & Trinity Counties

Area 2: Remainder

TRINITY COUNTY:

Area 1: East Central part and the Northeaster border with Shasta County

Area 2: Remainder

TULARE COUNTY;

Area 1: Remainder

Area 2: Eastern part

TUOLUMNE COUNTY:

Area 1: Remainder

Area 2: Eastern Part

-----  
IRON0377-002 01/01/2019

	Rates	Fringes
Ironworkers:		
Fence Erector.....	\$ 32.58	23.41
Ornamental, Reinforcing and Structural.....	\$ 39.00	32.05

PREMIUM PAY:

\$6.00 additional per hour at the following locations:

China Lake Naval Test Station, Chocolate Mountains Naval Reserve-Niland, Edwards AFB, Fort Irwin Military Station, Fort Irwin Training Center-Goldstone, San Clemente Island, San Nicholas Island, Susanville Federal Prison, 29 Palms - Marine Corps, U.S. Marine Base - Barstow, U.S. Naval Air Facility - Sealey, Vandenberg AFB

\$4.00 additional per hour at the following locations:

Army Defense Language Institute - Monterey, Fallon Air Base, Naval Post Graduate School - Monterey, Yermo Marine Corps Logistics Center

\$2.00 additional per hour at the following locations:

Port Hueneme, Port Mugu, U.S. Coast Guard Station - Two Rock

-----  
LABO0067-001 12/01/2018

AREA "A" - MARIN COUNTY

AREA "B" - ALPINE, AMADOR, BUTTE COLUSA EL DORADO, GLENN, LASSEN, MODOC, NAPA, NEVADA, PLACER, PLUMAS, SACRAMENTO, SHASTA, SIERRA, SISKIYOU, SOLANO, SONOMA, SUTTER, TEHAMA, TRINITY, YOLO, AND YUBA COUNTIES

	Rates	Fringes
Asbestos Removal Laborer.....	\$ 24.00	11.13
LABORER (Lead Removal)		
Marin County.....	\$ 31.81	22.71
Remaining Counties.....	\$ 30.81	22.71

LABO0067-005 06/27/2017

AREA "A" - ALAMEDA, CONTRA COSTA, MARIN, SAN FRANCISCO, SAN MATEO AND SANTA CLARA COUNTIES

AREA "B" - ALPINE, AMADOR, BUTTE, CALAVERAS, COLUSA, DEL NORTE, EL DORADO, FRESNO, GLENN, HUMBOLDT, KINGS, LAKE, LASSEN, MADERA, MARIPOSA, MENDOCINO, MERCED, MODOC, MONTEREY, NAPA, NEVADA, PLACER, PLUMAS, SACRAMENTO, SAN BENITO, SAN JOAQUIN, SANTA CRUZ, SIERRA, SHASTA, SISKIYOU, SOLANO, SONOMA, STANISLAUS, TEHAMA, TRINITY, TULARE, TUOLUMNE, YOLO AND YUBA COUNTIES

	Rates	Fringes
LABORER (TRAFFIC CONTROL/LANE CLOSURE)		
Escort Driver, Flag Person		
Area A.....	\$ 29.54	22.17
Area B.....	\$ 28.54	22.17
Traffic Control Person I		
Area A.....	\$ 29.84	22.17
Area B.....	\$ 28.84	22.17
Traffic Control Person II		
Area A.....	\$ 27.34	22.17
Area B.....	\$ 26.34	22.17

TRAFFIC CONTROL PERSON I: Layout of traffic control, crash cushions, construction area and roadside signage.

TRAFFIC CONTROL PERSON II: Installation and removal of temporary/permanent signs, markers, delineators and crash cushions.

LABO0185-002 07/01/2018

ALPINE, AMADOR, BUTTE, COLUSA, EL DORADO, GLENN, LASSEN, MODOC, NEVADA, PLACER, PLUMAS, SACRAMENTO, SHASTA, SIERRA, SISKIYOU, SUTTER, TEHAMA, TRINITY, YOLO AND YUBA COUNTIES

	Rates	Fringes
LABORER		
Mason Tender-Brick.....	\$ 31.20	22.20

LABO0185-005 06/25/2018

ALPINE, AMADOR, BUTTE, COLUSA, EL DORADO, GLENN, LASSEN, MODOC, NEVADA, PLACER, PLUMAS, SACRAMENTO, SHASTA, SIERRA, SISKIYOU, SUTTER, TEHAMA, TRINITY, YOLO AND YUBA COUNTIES

	Rates	Fringes
Tunnel and Shaft Laborers:		
GROUP 1.....	\$ 37.82	24.11
GROUP 2.....	\$ 37.59	24.11
GROUP 3.....	\$ 37.34	24.11
GROUP 4.....	\$ 36.89	24.11
GROUP 5.....	\$ 36.35	24.11
Shotcrete Specialist.....	\$ 38.34	24.11

TUNNEL AND SHAFT CLASSIFICATIONS

GROUP 1: Diamond driller; Groundmen; Guniting and shotcrete nozzle men

GROUP 2: Rodmen; Shaft work & raise (below actual or excavated ground level)

GROUP 3: Bit grinder; Blaster, driller, powdermen, heading; Cherry pickers - where car is lifted; Concrete finisher in tunnel; Concrete screedman; Grout pumpman and potman; Guniting & shotcrete gunner & potman; Headermen; High pressure nozzleman; Miner - tunnel, including top and bottom man on shaft and raise work; Nipper; Nozzleman on slick line; Sandblaster - potman, Robotic Shotcrete Placer, Segment Erector, Tunnel Muck Hauler, Steel Form raiser and setter; Timberman, retimberman (wood or steel or substitute materials therefore); Tugger (for tunnel laborer work); Cable tender; Chuck tender; Powderman - primer house

GROUP 4: Vibrator operator, pavement breaker; Bull gang - muckers, trackmen; Concrete crew - includes rodding and spreading, Dumpmen (any method)

GROUP 5: Grout crew; Reboundman; Swamper/ Brakeman

-----  
LABO0185-006 06/25/2018

ALPINE, AMADOR, BUTTE, COLUSA, EL DORADO, GLENN, LASSEN, MODOC, NEVADA, PLACER, PLUMAS, SACRAMENTO, SHASTA, SIERRA, SISKIYOU, SUTTER, TEHAMA, TRINITY, YOLO, YUBA COUNTIES

	Rates	Fringes
LABORER (CONSTRUCTION CRAFT LABORERS - AREA B:)		
Construction Specialist		
Group.....	\$ 30.49	23.20
GROUP 1.....	\$ 29.79	23.20
GROUP 1-a.....	\$ 30.01	23.20
GROUP 1-c.....	\$ 30.01	23.20
GROUP 1-e.....	\$ 30.34	23.20
GROUP 1-f.....	\$ 30.37	23.20
GROUP 2.....	\$ 29.64	23.20
GROUP 3.....	\$ 29.54	23.20
GROUP 4.....	\$ 23.23	23.20

See groups 1-b and 1-d under laborer classifications.

LABORER (GARDENERS,  
HORTICULTURAL & LANDSCAPE  
LABORERS - AREA B:)

(1) New Construction.....	\$ 29.54	23.20
(2) Establishment Warranty Period.....	\$ 23.23	23.20

LABORER (GUNITE - AREA B:)

GROUP 1.....	\$ 29.75	22.31
GROUP 2.....	\$ 29.25	22.31
GROUP 3.....	\$ 28.66	22.31
GROUP 4.....	\$ 28.54	22.31

LABORER (WRECKING - AREA B:)

GROUP 1.....	\$ 29.79	23.20
GROUP 2.....	\$ 29.64	23.20

FOOTNOTES:

Laborers working off or with or from bos'n chairs, swinging scaffolds, belts shall receive \$0.25 per hour above the applicable wage rate. This shall not apply to workers entitled to receive the wage rate set forth in Group 1-a below.

LABORER CLASSIFICATIONS

CONSTRUCTION SPECIALIST GROUP: Asphalt ironer and raker; Chainsaw; Laser beam in connection with laborers' work; Cast-in- place manhole form setter; Pressure pipelayer; Davis trencher - 300 or similar type (and all small trenchers); Blaster; Diamond driller; Multiple unit drill; Hydraulic drill

GROUP 1: Asphalt spreader boxes (all types); Barko, Wacker and similar type tampers; Buggymobile; Caulker, bander, pipewrapper, conduit layer, plastic pipelayer; Certified hazardous waste worker including Leade Abatement; Compactors of all types; Concrete and magnesite mixer, 1/2 yd. and under; Concrete pan work; Concrete sander; Concrete saw; Cribber and/or shoring; Cut granite curb setter; Dri-pak-it machine; Faller, logloader and bucket; Form raiser, slip forms; Green cutter; Headerboard, Hubsetter, aligner, by any method; High pressure blow pipe (1-1/2" or over, 100 lbs. pressure/over); Hydro seeder and similar type; Jackhammer operator; Jacking of pipe over 12 inches; Jackson and similar type compactor; Kettle tender, pot and worker applying asphalt, lay-kold, creosote, lime, caustic and similar type materials (applying means applying, dipping or handling of such materials); Lagging, sheeting, whaling, bracing, trenchjacking, lagging hammer; Magnesite, epoxyresin, fiberglass, mastic worker (wet or dry); No joint pipe and stripping of same, including repair of voids; Pavement breaker and spader, including tool grinder; Perma curb; Pipelayer (including grade checking in connection with pipelaying); Precast-manhole setter; Pressure pipe tester; Post hole digger, air, gas and electric; Power broom sweeper; Power tampers of all types (except as shown in Group 2); Ram set gun and stud gun;

Riprap stonepaver and rock-slinger, including placing of sacked concrete and/or sand (wet or dry) and gabions and similar type; Rotary scarifier or multiple head concrete chipping scarifier; Roto and Ditch Witch; Rototiller; Sandblaster, pot, gun, nozzle operators; Signalling and rigging; Tank cleaner; Tree climber; Turbo blaster; Vibrascreed, bull float in connection with laborers' work; Vibrator; Hazardous waste worker (lead removal); Asbestos and mold removal worker

GROUP 1-a: Joy drill model TWM-2A; Gardner-Denver model DH143 and similar type drills; Track driller; Jack leg driller; Wagon driller; Mechanical drillers, all types regardless of type or method of power; Mechanical pipe layers, all types regardless of type or method of power; Blaster and powder; All work of loading, placing and blasting of all powder and explosives of whatever type regardless of method used for such loading and placing; High scalers (including drilling of same); Tree topper; Bit grinder

GROUP 1-b: Sewer cleaners shall receive \$4.00 per day above Group 1 wage rates. "Sewer cleaner" means any worker who handles or comes in contact with raw sewage in small diameter sewers. Those who work inside recently active, large diameter sewers, and all recently active sewer manholes shall receive \$5.00 per day above Group 1 wage rates.

GROUP 1-c: Burning and welding in connection with laborers' work; Synthetic thermoplastics and similar type welding

GROUP 1-d: Maintenance and repair track and road beds. All employees performing work covered herein shall receive \$ .25 per hour above their regular rate for all work performed on underground structures not specifically covered herein. This paragraph shall not be construed to apply to work below ground level in open cut. It shall apply to cut and cover work of subway construction after the temporary cover has been placed.

GROUP 1-e: Work on and/or in bell hole footings and shafts thereof, and work on and in deep footings. (A deep footing is a hole 15 feet or more in depth.) In the event the depth of the footing is unknown at the commencement of excavation, and the final depth exceeds 15 feet, the deep footing wage rate would apply to all employees for each and every day worked on or in the excavation of the footing from the date of inception.

GROUP 1-f: Wire winding machine in connection with guniting or shot crete

GROUP 2: Asphalt shoveler; Cement dumper and handling dry cement or gypsum; Choke-setter and rigger (clearing work); Concrete bucket dumper and chute; Concrete chipping and grinding; Concrete laborer (wet or dry); Driller tender, chuck tender, nipper; Guinea chaser (stake), grout crew; High pressure nozzle, adductor; Hydraulic monitor (over 100 lbs. pressure); Loading and unloading, carrying and hauling of all rods and materials for use in reinforcing concrete

construction; Pittsburgh chipper and similar type brush shredders; Sloper; Single foot, hand-held, pneumatic tamper; All pneumatic, air, gas and electric tools not listed in Groups 1 through 1-f; Jacking of pipe - under 12 inches

GROUP 3: Construction laborers, including bridge and general laborer; Dump, load spotter; Flag person; Fire watcher; Fence erector; Guardrail erector; Gardener, horticultural and landscape laborer; Jetting; Limber, brush loader and piler; Pavement marker (button setter); Maintenance, repair track and road beds; Streetcar and railroad construction track laborer; Temporary air and water lines, Victaulic or similar; Tool room attendant (jobsite only)

GROUP 4: Final clean-up work of debris, grounds and building including but not limited to: street cleaner; cleaning and washing windows; brick cleaner (jobsite only); material cleaner (jobsite only). The classification "material cleaner" is to be utilized under the following conditions:

- A: at demolition site for the salvage of the material.
- B: at the conclusion of a job where the material is to be salvaged and stocked to be reused on another job.
- C: for the cleaning of salvage material at the jobsite or temporary jobsite yard.

The material cleaner classification should not be used in the performance of "form stripping, cleaning and oiling and moving to the next point of erection".

-----

GUNITE LABORER CLASSIFICATIONS

- GROUP 1: Structural Nozzleman
- GROUP 2: Nozzleman, Gunman, Potman, Groundman
- GROUP 3: Reboundman
- GROUP 4: Gunite laborer

-----

WRECKING WORK LABORER CLASSIFICATIONS

- GROUP 1: Skilled wrecker (removing and salvaging of sash, windows and materials)
- GROUP 2: Semi-skilled wrecker (salvaging of other building materials)

-----

LABO0185-008 07/01/2018

	Rates	Fringes
Plasterer tender.....	\$ 32.02	23.00
Work on a swing stage scaffold: \$1.00 per hour additional.		

LABO0261-002 06/25/2018

MARIN COUNTY

	Rates	Fringes
LABORER (TRAFFIC CONTROL/LANE CLOSURE)		
Escort Driver, Flag Person..\$	30.54	23.65
Traffic Control Person I....\$	30.84	23.65
Traffic Control Person II...\$	28.34	23.65

TRAFFIC CONTROL PERSON I: Layout of traffic control, crash cushions, construction area and roadside signage.

TRAFFIC CONTROL PERSON II: Installation and removal of temporary/permanent signs, markers, delineators and crash cushions.

LABO0261-004 06/25/2018

MARIN COUNTY

	Rates	Fringes
Tunnel and Shaft Laborers:		
GROUP 1.....\$	37.82	24.11
GROUP 2.....\$	37.59	24.11
GROUP 3.....\$	37.34	24.11
GROUP 4.....\$	36.89	24.11
GROUP 5.....\$	36.35	24.11
Shotcrete Specialist.....\$	38.34	24.11

TUNNEL AND SHAFT CLASSIFICATIONS

GROUP 1: Diamond driller; Groundmen; Gunite and shotcrete nozzlemen

GROUP 2: Rodmen; Shaft work & raise (below actual or excavated ground level)

GROUP 3: Bit grinder; Blaster, driller, powdermen, heading; Cherry pickermen - where car is lifted; Concrete finisher in tunnel; Concrete screedman; Grout pumpman and potman; Gunite & shotcrete gunman & potman; Headermen; High pressure nozzleman; Miner - tunnel, including top and bottom man on shaft and raise work; Nipper; Nozzleman on slick line; Sandblaster - potman, Robotic Shotcrete Placer, Segment Erector, Tunnel Muck Hauler, Steel Form raiser and setter; Timberman, retimberman (wood or steel or substitute materials therefore); Tugger (for tunnel laborer work); Cable tender; Chuck tender; Powderman - primer house

GROUP 4: Vibrator operator, pavement breaker; Bull gang - muckers, trackmen; Concrete crew - includes rodding and spreading, Dumpmen (any method)

GROUP 5: Grout crew; Reboundman; Swamper/ Brakeman

LABO0261-007 07/01/2018

MARIN AND NAPA COUNTIES

	Rates	Fringes
LABORER		
Mason Tender-Brick.....	\$ 32.45	22.20

LABO0261-010 06/25/2018

MARIN COUNTY

	Rates	Fringes
LABORER (CONSTRUCTION CRAFT LABORERS - AREA A:)		
Construction Specialist Group.....	\$ 31.49	23.20
GROUP 1.....	\$ 30.79	23.20
GROUP 1-a.....	\$ 31.01	23.20
GROUP 1-c.....	\$ 30.84	23.20
GROUP 1-e.....	\$ 31.34	23.20
GROUP 1-f.....	\$ 31.37	23.20
GROUP 2.....	\$ 30.64	23.20
GROUP 3.....	\$ 30.54	23.20
GROUP 4.....	\$ 24.23	23.20

See groups 1-b and 1-d under laborer classifications.

LABORER (GARDENERS,  
HORTICULTURAL & LANDSCAPE

LABORERS - AREA A:)		
(1) New Construction.....	\$ 30.54	23.20
(2) Establishment Warranty Period.....	\$ 24.23	23.20

LABORER (GUNITE - AREA A:)

GROUP 1.....	\$ 30.75	22.31
GROUP 2.....	\$ 30.25	22.31
GROUP 3.....	\$ 29.66	22.31
GROUP 4.....	\$ 29.54	22.31

LABORER (WRECKING - AREA A:)

GROUP 1.....	\$ 30.79	23.20
GROUP 2.....	\$ 30.64	23.20

FOOTNOTES:

Laborers working off or with or from bos'n chairs, swinging scaffolds, belts shall receive \$0.25 per hour above the applicable wage rate. This shall not apply to workers entitled to receive the wage rate set forth in Group 1-a below.

LABORER CLASSIFICATIONS

CONSTRUCTION SPECIALIST GROUP: Asphalt ironer and raker; Chainsaw; Laser beam in connection with laborers' work; Cast-in-place manhole form setter; Pressure pipelayer;



Davis trencher - 300 or similar type (and all small trenchers); Blaster; Diamond driller; Multiple unit drill; Hydraulic drill

GROUP 1: Asphalt spreader boxes (all types); Barko, Wacker and similar type tampers; Buggymobile; Caulker, bander, pipewrapper, conduit layer, plastic pipelayer; Certified hazardous waste worker including Leade Abatement; Compactors of all types; Concrete and magnesite mixer, 1/2 yd. and under; Concrete pan work; Concrete sander; Concrete saw; Cribber and/or shoring; Cut granite curb setter; Dri-pak-it machine; Faller, logloader and buckler; Form raiser, slip forms; Green cutter; Headerboard, Hubsetter, aligner, by any method; High pressure blow pipe (1-1/2" or over, 100 lbs. pressure/over); Hydro seeder and similar type; Jackhammer operator; Jacking of pipe over 12 inches; Jackson and similar type compactor; Kettle tender, pot and worker applying asphalt, lay-kold, creosote, lime, caustic and similar type materials (applying means applying, dipping or handling of such materials); Lagging, sheeting, whaling, bracing, trenchjacking, lagging hammer; Magnesite, epoxyresin, fiberglass, mastic worker (wet or dry); No joint pipe and stripping of same, including repair of voids; Pavement breaker and spader, including tool grinder; Perma curb; Pipelayer (including grade checking in connection with pipelaying); Precast-manhole setter; Pressure pipe tester; Post hole digger, air, gas and electric; Power broom sweeper; Power tampers of all types (except as shown in Group 2); Ram set gun and stud gun; Riprap stonepaver and rock-slinger, including placing of sacked concrete and/or sand (wet or dry) and gabions and similar type; Rotary scarifier or multiple head concrete chipping scarifier; Roto and Ditch Witch; Rototiller; Sandblaster, pot, gun, nozzle operators; Signalling and rigging; Tank cleaner; Tree climber; Turbo blaster; Vibrascreed, bull float in connection with laborers' work; Vibrator; Hazardous waste worker (lead removal); Asbestos and mold removal worker

GROUP 1-a: Joy drill model TWM-2A; Gardner-Denver model DH143 and similar type drills; Track driller; Jack leg driller; Wagon driller; Mechanical drillers, all types regardless of type or method of power; Mechanical pipe layers, all types regardless of type or method of power; Blaster and powder; All work of loading, placing and blasting of all powder and explosives of whatever type regardless of method used for such loading and placing; High scalers (including drilling of same); Tree topper; Bit grinder

GROUP 1-b: Sewer cleaners shall receive \$4.00 per day above Group 1 wage rates. "Sewer cleaner" means any worker who handles or comes in contact with raw sewage in small diameter sewers. Those who work inside recently active, large diameter sewers, and all recently active sewer manholes shal receive \$5.00 per day above Group 1 wage rates.

GROUP 1-c: Burning and welding in connection with laborers' work; Synthetic thermoplastics and similar type welding

GROUP 1-d: Maintenance and repair track and road beds. All employees performing work covered herein shall receive \$ .25 per hour above their regular rate for all work performed on underground structures not specifically covered herein. This paragraph shall not be construed to apply to work below ground level in open cut. It shall apply to cut and cover work of subway construction after the temporary cover has been placed.

GROUP 1-e: Work on and/or in bell hole footings and shafts thereof, and work on and in deep footings. (A deep footing is a hole 15 feet or more in depth.) In the event the depth of the footing is unknown at the commencement of excavation, and the final depth exceeds 15 feet, the deep footing wage rate would apply to all employees for each and every day worked on or in the excavation of the footing from the date of inception.

GROUP 1-f: Wire winding machine in connection with guniting or shot crete

GROUP 2: Asphalt shoveler; Cement dumper and handling dry cement or gypsum; Choke-setter and rigger (clearing work); Concrete bucket dumper and chute; Concrete chipping and grinding; Concrete laborer (wet or dry); Driller tender, chuck tender, nipper; Guinea chaser (stake), grout crew; High pressure nozzle, adductor; Hydraulic monitor (over 100 lbs. pressure); Loading and unloading, carrying and hauling of all rods and materials for use in reinforcing concrete construction; Pittsburgh chipper and similar type brush shredders; Sloper; Single foot, hand-held, pneumatic tamper; All pneumatic, air, gas and electric tools not listed in Groups 1 through 1-f; Jacking of pipe - under 12 inches

GROUP 3: Construction laborers, including bridge and general laborer; Dump, load spotter; Flag person; Fire watcher; Fence erector; Guardrail erector; Gardener, horticultural and landscape laborer; Jetting; Limber, brush loader and piler; Pavement marker (button setter); Maintenance, repair track and road beds; Streetcar and railroad construction track laborer; Temporary air and water lines, Victaulic or similar; Tool room attendant (jobsite only)

GROUP 4: Final clean-up work of debris, grounds and building including but not limited to: street cleaner; cleaning and washing windows; brick cleaner (jobsite only); material cleaner (jobsite only). The classification "material cleaner" is to be utilized under the following conditions:  
A: at demolition site for the salvage of the material.  
B: at the conclusion of a job where the material is to be salvaged and stocked to be reused on another job.  
C: for the cleaning of salvage material at the jobsite or temporary jobsite yard.

The material cleaner classification should not be used in the performance of "form stripping, cleaning and oiling and moving to the next point of erection".

GUNITE LABORER CLASSIFICATIONS

GROUP 1: Structural Nozzleman

GROUP 2: Nozzleman, Gunman, Potman, Groundman

GROUP 3: Reboundman

GROUP 4: Gunite laborer

-----  
WRECKING WORK LABORER CLASSIFICATIONS

GROUP 1: Skilled wrecker (removing and salvaging of sash, windows and materials)

GROUP 2: Semi-skilled wrecker (salvaging of other building materials)

-----  
LABO0261-015 07/01/2018

	Rates	Fringes
Plasterer tender.....	\$ 32.02	23.00
Work on a swing stage scaffold: \$1.00 per hour additional.		

-----  
LABO0324-004 06/25/2018

NAPA, SOLANO, AND SONOMA, COUNTIES

	Rates	Fringes
LABORER (TRAFFIC CONTROL/LANE CLOSURE)		
Escort Driver, Flag Person..	\$ 29.54	23.65
Traffic Control Person I....	\$ 29.84	23.65
Traffic Control Person II....	\$ 27.34	23.65

TRAFFIC CONTROL PERSON I: Layout of traffic control, crash cushions, construction area and roadside signage.

TRAFFIC CONTROL PERSON II: Installation and removal of temporary/permanent signs, markers, delineators and crash cushions.

-----  
LABO0324-008 06/25/2018

NAPA, SOLANO, AND SONOMA COUNTIES

	Rates	Fringes
Tunnel and Shaft Laborers:		
GROUP 1.....	\$ 37.82	24.11
GROUP 2.....	\$ 37.59	24.11
GROUP 3.....	\$ 37.34	24.11

GROUP 4.....	\$ 36.89	24.11
GROUP 5.....	\$ 36.35	24.11
Shotcrete Specialist.....	\$ 38.34	24.11

TUNNEL AND SHAFT CLASSIFICATIONS

GROUP 1: Diamond driller; Groundmen; Gunite and shotcrete nozzlemen

GROUP 2: Rodmen; Shaft work & raise (below actual or excavated ground level)

GROUP 3: Bit grinder; Blaster, driller, powdermen, heading; Cherry pickermen - where car is lifted; Concrete finisher in tunnel; Concrete screedman; Grout pumpman and potman; Gunite & shotcrete gunman & potman; Headermen; High pressure nozzleman; Miner - tunnel, including top and bottom man on shaft and raise work; Nipper; Nozzleman on slick line; Sandblaster - potman, Robotic Shotcrete Placer, Segment Erector, Tunnel Muck Hauler, Steel Form raiser and setter; Timberman, retimberman (wood or steel or substitute materials therefore); Tugger (for tunnel laborer work); Cable tender; Chuck tender; Powderman - primer house

GROUP 4: Vibrator operator, pavement breaker; Bull gang - muckers, trackmen; Concrete crew - includes rodding and spreading, Dumpmen (any method)

GROUP 5: Grout crew; Reboundman; Swamper/ Brakeman

-----  
LABO0324-010 07/01/2018

SOLANO AND SONOMA COUNTIES

	Rates	Fringes
LABORER		
Mason Tender-Brick.....	\$ 31.45	22.20

-----  
LABO0324-013 06/25/2018

NAPA, SOLANO, AND SONOMA COUNTIES

	Rates	Fringes
LABORER (CONSTRUCTION CRAFT		
LABORERS - AREA B:)		
Construction Specialist		
Group.....	\$ 30.49	23.20
GROUP 1.....	\$ 29.79	23.20
GROUP 1-a.....	\$ 30.01	23.20
GROUP 1-c.....	\$ 29.84	23.20
GROUP 1-e.....	\$ 30.34	23.20
GROUP 1-f.....	\$ 29.37	23.20
GROUP 2.....	\$ 29.64	23.20
GROUP 3.....	\$ 29.54	23.20
GROUP 4.....	\$ 23.23	23.20

See groups 1-b and 1-d under laborer classifications.

LABORER (GARDENERS,

HORTICULTURAL & LANDSCAPE

LABORERS - AREA B:)

(1) New Construction.....	\$ 29.54	23.20
(2) Establishment Warranty Period.....	\$ 23.23	23.20

LABORER (GUNITE - AREA B:)

GROUP 1.....	\$ 29.75	22.31
GROUP 2.....	\$ 29.25	22.31
GROUP 3.....	\$ 28.66	22.31
GROUP 4.....	\$ 28.54	22.31

LABORER (WRECKING - AREA B:)

GROUP 1.....	\$ 29.79	23.20
GROUP 2.....	\$ 29.64	23.20

FOOTNOTES:

Laborers working off or with or from bos'n chairs, swinging scaffolds, belts shall receive \$0.25 per hour above the applicable wage rate. This shall not apply to workers entitled to receive the wage rate set forth in Group 1-a below.

LABORER CLASSIFICATIONS

CONSTRUCTION SPECIALIST GROUP: Asphalt ironer and raker; Chainsaw; Laser beam in connection with laborers' work; Cast-in- place manhole form setter; Pressure pipelayer; Davis trencher - 300 or similar type (and all small trenchers); Blaster; Diamond drilller; Multiple unit drill; Hydraulic drill

GROUP 1: Asphalt spreader boxes (all types); Barko, Wacker and similar type tampers; Buggymobile; Caulker, bander, pipewrapper, conduit layer, plastic pipelayer; Certified hazardous waste worker including Leade Abatement; Compactors of all types; Concrete and magnesite mixer, 1/2 yd. and under; Concrete pan work; Concrete sander; Concrete saw; Cribber and/or shoring; Cut granite curb setter; Dri-pak-it machine; Faller, logloader and buckler; Form raiser, slip forms; Green cutter; Headerboard, Hubsetter, aligner, by any method; High pressure blow pipe (1-1/2" or over, 100 lbs. pressure/over); Hydro seeder and similar type; Jackhammer operator; Jacking of pipe over 12 inches; Jackson and similar type compactor; Kettle tender, pot and worker applying asphalt, lay-kold, creosote, lime, caustic and similar type materials (applying means applying, dipping or handling of such materials); Lagging, sheeting, whaling, bracing, trenchjacking, lagging hammer; Magnesite, epoxyresin, fiberglass, mastic worker (wet or dry); No joint pipe and stripping of same, including repair of voids; Pavement breaker and spader, including tool grinder; Perma curb; Pipelayer (including grade checking in connection with pipelaying); Precast-manhole setter; Pressure pipe tester; Post hole digger, air, gas and electric; Power broom sweeper; Power tampers of all types (except as shown in Group 2); Ram set gun and stud gun; Riprap stonepaver and rock-slinger, including placing of sacked concrete and/or sand (wet or dry) and gabions and

similar type; Rotary scarifier or multiple head concrete chipping scarifier; Roto and Ditch Witch; Rototiller; Sandblaster, pot, gun, nozzle operators; Signalling and rigging; Tank cleaner; Tree climber; Turbo blaster; Vibrascreed, bull float in connection with laborers' work; Vibrator; Hazardous waste worker (lead removal); Asbestos and mold removal worker

GROUP 1-a: Joy drill model TWM-2A; Gardner-Denver model DH143 and similar type drills; Track driller; Jack leg driller; Wagon driller; Mechanical drillers, all types regardless of type or method of power; Mechanical pipe layers, all types regardless of type or method of power; Blaster and powder; All work of loading, placing and blasting of all powder and explosives of whatever type regardless of method used for such loading and placing; High scalers (including drilling of same); Tree topper; Bit grinder

GROUP 1-b: Sewer cleaners shall receive \$4.00 per day above Group 1 wage rates. "Sewer cleaner" means any worker who handles or comes in contact with raw sewage in small diameter sewers. Those who work inside recently active, large diameter sewers, and all recently active sewer manholes shall receive \$5.00 per day above Group 1 wage rates.

GROUP 1-c: Burning and welding in connection with laborers' work; Synthetic thermoplastics and similar type welding

GROUP 1-d: Maintenance and repair track and road beds. All employees performing work covered herein shall receive \$ .25 per hour above their regular rate for all work performed on underground structures not specifically covered herein. This paragraph shall not be construed to apply to work below ground level in open cut. It shall apply to cut and cover work of subway construction after the temporary cover has been placed.

GROUP 1-e: Work on and/or in bell hole footings and shafts thereof, and work on and in deep footings. (A deep footing is a hole 15 feet or more in depth.) In the event the depth of the footing is unknown at the commencement of excavation, and the final depth exceeds 15 feet, the deep footing wage rate would apply to all employees for each and every day worked on or in the excavation of the footing from the date of inception.

GROUP 1-f: Wire winding machine in connection with gunning or shot crete

GROUP 2: Asphalt shoveler; Cement dumper and handling dry cement or gypsum; Choke-setter and rigger (clearing work); Concrete bucket dumper and chute; Concrete chipping and grinding; Concrete laborer (wet or dry); Driller tender, chuck tender, nipper; Guinea chaser (stake), grout crew; High pressure nozzle, adductor; Hydraulic monitor (over 100 lbs. pressure); Loading and unloading, carrying and hauling of all rods and materials for use in reinforcing concrete construction; Pittsburgh chipper and similar type brush shredders; Sloper; Single foot, hand-held, pneumatic

tamper; All pneumatic, air, gas and electric tools not listed in Groups 1 through 1-f; Jacking of pipe - under 12 inches

GROUP 3: Construction laborers, including bridge and general laborer; Dump, load spotter; Flag person; Fire watcher; Fence erector; Guardrail erector; Gardener, horticultural and landscape laborer; Jetting; Limber, brush loader and piler; Pavement marker (button setter); Maintenance, repair track and road beds; Streetcar and railroad construction track laborer; Temporary air and water lines, Victaulic or similar; Tool room attendant (jobsite only)

GROUP 4: Final clean-up work of debris, grounds and building including but not limited to: street cleaner; cleaning and washing windows; brick cleaner (jobsite only); material cleaner (jobsite only). The classification "material cleaner" is to be utilized under the following conditions:  
A: at demolition site for the salvage of the material.  
B: at the conclusion of a job where the material is to be salvaged and stocked to be reused on another job.  
C: for the cleaning of salvage material at the jobsite or temporary jobsite yard.

The material cleaner classification should not be used in the performance of "form stripping, cleaning and oiling and moving to the next point of erection".

-----  
GUNITE LABORER CLASSIFICATIONS

- GROUP 1: Structural Nozzleman
- GROUP 2: Nozzleman, Gunman, Potman, Groundman
- GROUP 3: Reboundman
- GROUP 4: Guniting laborer

-----  
WRECKING WORK LABORER CLASSIFICATIONS

- GROUP 1: Skilled wrecker (removing and salvaging of sash, windows and materials)
- GROUP 2: Semi-skilled wrecker (salvaging of other building materials)

-----  
LABO0324-019 07/01/2018

	Rates	Fringes
Plasterer tender.....	\$ 32.02	23.00
Work on a swing stage scaffold:	\$1.00 per hour additional.	

-----  
PAIN0016-004 01/01/2018

MARIN, NAPA, SOLANO & SONOMA COUNTIES

	Rates	Fringes
Painters:.....	\$ 40.62	23.83

PREMIUMS:

EXOTIC MATERIALS - \$0.75 additional per hour.

SPRAY WORK: - \$0.50 additional per hour.

INDUSTRIAL PAINTING - \$0.25 additional per hour

[Work on industrial buildings used for the manufacture and processing of goods for sale or service; steel construction (bridges), stacks, towers, tanks, and similar structures]

HIGH WORK:

over 50 feet - \$2.00 per hour additional

100 to 180 feet - \$4.00 per hour additional

Over 180 feet - \$6.00 per hour additional

-----  
PAIN0016-005 01/01/2018

ALPINE, BUTTE, COLUSA, EL DORADO (west of the Sierra Nevada Mountains), GLENN, LASSEN (west of Hwy. 395, excluding Honey Lake); MARIN, MODOC, NAPA, NEVADA (west of the Sierra Nevada Mountains), PLACER (west of the Sierra Nevada Mountains), PLUMAS, SACRAMENTO, SHASTA, SIERRA (west of the Sierra Nevada Mountains), SISKIYOU, SOLANO, SONOMA, SUTTER, TEHAMA, TRINITY, YOLO AND YUBA COUNTIES

	Rates	Fringes
DRYWALL FINISHER/TAPER.....	\$ 41.03	25.34

-----  
PAIN0016-007 01/01/2018

ALPINE, AMADOR, BUTTE, COLUSA, EL DORADO (west of the Sierra Nevada Mountains), GLENN, LASSEN (west of Highway 395, excluding Honey Lake), MODOC, NEVADA (west of the Sierra Nevada Mountains), PLACER (west of the Sierra Nevada Mountains), PLUMAS, SACRAMENTO, SHASTA, SIERRA (west of the Sierra Nevada Mountains), SISKIYOU, SUTTER, TEHAMA, TRINITY, YOLO & YUBA COUNTIES

	Rates	Fringes
Painters:.....	\$ 32.91	19.26

SPRAY/SANDBLAST: \$0.50 additional per hour.

EXOTIC MATERIALS: \$1.00 additional per hour.

HIGH TIME: Over 50 ft above ground or water level \$2.00 additional per hour. 100 to 180 ft above ground or water level \$4.00 additional per hour. Over 180 ft above ground or water level \$6.00 additional per hour.

-----  
PAIN0016-008 01/01/2018



MARIN, NAPA, SOLANO AND SONOMA COUNTIES

	Rates	Fringes
SOFT FLOOR LAYER.....	\$ 48.00	26.03

PAIN0169-004 07/01/2018

MARIN , NAPA & SONOMA COUNTIES; SOLANO COUNTY (west of a line defined as follows: Hwy. 80 corridor beginning at the City of Fairfield, including Travis Air Force Base and Suisun City; going north of Manakas Corner Rd., continue north on Suisun Valley Rd. to the Napa County line; Hwy. 80 corridor south on Grizzly Island Rd. to the Grizzly Island Management area)

	Rates	Fringes
GLAZIER.....	\$ 49.13	28.09

\* PAIN0567-001 07/01/2018

EL DORADO COUNTY (east of the Sierra Nevada Mountains); LASSEN COUNTY (east of Highway 395, beginning at Stacey and including Honey Lake); NEVADA COUNTY (east of the Sierra Nevada Mountains); PLACER COUNTY (east of the Sierra Nevada Mountains); AND SIERRA COUNTY (east of the Sierra Nevada Mountains)

	Rates	Fringes
Painters:		
Brush and Roller.....	\$ 26.70	13.04
Spray Painter & Paperhanger.	\$ 28.04	13.04

PREMIUMS:  
 Special Coatings (Brush), and Sandblasting = \$0.50/hr  
 Special Coatings (Spray), and Steeplejack = \$1.00/hr  
 Special Coating Spray Steel = \$1.25/hr  
 Swing Stage = \$2.00/hr

\*A special coating is a coating that requires the mixing of 2 or more products.

PAIN0567-007 07/01/2018

EL DORADO COUNTY (east of the Sierra Nevada Mountains); LASSEN COUNTY (east of Highway 395, beginning at Stacey and including Honey Lake); NEVADA COUNTY (east of the Sierra Nevada Mountains); PLACER COUNTY (east of the Sierra Nevada Mountains) AND SIERRA COUNTY (east of the Sierra Nevada Mountains)

	Rates	Fringes
SOFT FLOOR LAYER.....	\$ 29.10	13.14

PAIN0567-010 07/01/2018

EL DORADO COUNTY (east of the Sierra Nevada Mountains); LASSEN COUNTY (east of Highway 395, beginning at Stacey and including Honey Lake); NEVADA COUNTY (east of the Sierra Nevada Mountains); PLACER COUNTY (east of the Sierra Nevada Mountains); AND SIERRA COUNTY (east of the Sierra Nevada Mountains)

	Rates	Fringes
Drywall		
(1) Taper.....	\$ 31.82	13.04
(2) Steeplejack - Taper, over 40 ft with open space below.....	\$ 33.32	13.04

PAIN0767-004 07/01/2018

ALPINE, AMADOR, BUTTE, COLUSA, EL DORADO, GLENN, LASSEN, MODOC, NEVADA, PLACER, PLUMAS, SACRAMENTO, SHASTA, SIERRA, SISKIYOU, SOLANO (Remainder), SUTTER, TEHAMA, TRINITY, YOLO, YUBA

	Rates	Fringes
GLAZIER.....	\$ 37.57	28.30

PAID HOLIDAYS: New Year's Day, Martin Luther King, Jr. Day, President's Day, Memorial Day, Independence Day, Labor Day, Veteran's Day, Thanksgiving Day, and Christmas Day.

Employee required to wear a body harness shall receive \$1.50 per hour above the basic hourly rate at any elevation.

PAIN1176-001 01/01/2017

HIGHWAY IMPROVEMENT

	Rates	Fringes
Parking Lot Striping/Highway Marking:		
GROUP 1.....	\$ 34.41	16.31
GROUP 2.....	\$ 29.25	16.31
GROUP 3.....	\$ 29.59	16.31

CLASSIFICATIONS

GROUP 1: Striper: Layout and application of painted traffic stripes and marking; hot thermo plastic; tape, traffic stripes and markings

GROUP 2: Gamecourt & Playground Installer

GROUP 3: Protective Coating, Pavement Sealing

PAIN1237-001 10/01/2018

ALPINE; COLUSA; EL DORADO (west of the Sierra Nevada Mountains); GLENN; LASSEN (west of Highway 395, beginning at Stacey and including Honey Lake); MODOC; NEVADA (west of the Sierra Nevada Mountains); PLACER (west of the Sierra Nevada Mountains); PLUMAS; SACRAMENTO; SHASTA; SIERRA (west of the Sierra Nevada Mountains); SISKIYOU; SUTTER; TEHAMA; TRINITY; YOLO AND YUBA COUNTIES

	Rates	Fringes
SOFT FLOOR LAYER.....	\$ 36.81	21.51

-----  
PLAS0300-003 07/01/2018

	Rates	Fringes
PLASTERER		
AREA 295: Alpine, Amador, Butte, Colusa, El Dorado, Glenn, Lassen, Modoc, Nevada, Placer, Plumas, Sacramento, Shasta, Sierra, Siskiyou, Solano, Sutter, Tehema, Trinity, Yolo & Yuba Counties.....	\$ 32.70	31.68
AREA 355: Marin.....	\$ 36.73	31.68
AREA 355: Napa & Sonoma Counties.....	\$ 32.70	31.68

-----  
PLAS0300-005 07/01/2017

	Rates	Fringes
CEMENT MASON/CONCRETE FINISHER...	\$ 33.49	23.67

-----  
PLUM0038-002 07/01/2018

MARIN AND SONOMA COUNTIES

	Rates	Fringes
PLUMBER (Plumber, Steamfitter, Refrigeration Fitter)		
(1) Work on wooden frame structures 5 stories or less excluding high-rise buildings and commercial work such as hospitals, prisons, hotels, schools, casinos, wastewater treatment plants, and research facilities as well as refrigeration pipefitting, service and repair work - MARKET RECOVERY RATE.....	\$ 72.00	41.94

(2) All other work - NEW  
 CONSTRUCTION RATE.....\$ 72.00 41.94

PLUM0038-006 07/01/2018

MARIN & SONOMA COUNTIES

	Rates	Fringes
Landscape/Irrigation Fitter (Underground/Utility Fitter).....	\$ 61.20	30.17

PLUM0228-001 01/01/2019

BUTTE, COLUSA, GLENN, LASSEN, MODOC, PLUMAS, SHASTA, SIERRA,  
 SISKIYOU, SUTTER, TEHAMA, TRINITY & YUBA COUNTIES

	Rates	Fringes
PLUMBER.....	\$ 40.00	31.89

PLUM0343-001 01/01/2019

NAPA AND SOLANO COUNTIES

	Rates	Fringes
PLUMBER/PIPEFITTER		
Light Commercial.....	\$ 30.85	20.40
All Other Work.....	\$ 51.00	38.50

DEFINITION OF LIGHT COMMERCIAL:

Work shall include strip shopping centers, office buildings, schools and other commercial structures which the total plumbing bid does not exceed Two Hundred and Fifty Thousand (\$250,000) and the total heating and cooling does not exceed Two Hundred Fifty Thousand (\$250,000); or Any projects bid in phases shall not qualify unless the total project is less than Two Hundred Fifty Thousand (\$250,000) for the plumbing bid; and Two Hundred Fifty Thousand (\$250,000) for the heating and cooling bid. Excluded are hospitals, jails, institutions and industrial projects, regardless size of the project

FOOTNOTES: While fitting galvanized material: \$.75 per hour additional. Work from trusses, temporary staging, unguarded structures 35' from the ground or water: \$.75 per hour additional. Work from swinging scaffolds, boatswains chairs or similar devices: \$.75 per hour additional.

PLUM0350-001 08/01/2018

EL DORADO COUNTY (Lake Tahoe area only); NEVADA COUNTY (Lake Tahoe area only); AND PLACER COUNTY (Lake Tahoe area only)

Rates	Fringes
-------	---------

PLUMBER/PIPEFITTER.....\$ 42.84 13.81

-----  
PLUM0355-001 07/01/2018

ALPINE, AMADOR, BUTTE, COLUSA, EL DORADO, GLENN, LASSEN, MODOC,  
NAPA, NEVADA, PLACER, PLUMAS, SACRAMENTO, SHASTA, SIERRA,  
SISKIYOU, SOLANO, SUTTER, TEHAMA, TRINITY, YOLO, AND YUBA  
COUNTIES

	Rates	Fringes
Underground Utility Worker /Landscape Fitter.....	\$ 27.10	16.30

-----  
PLUM0442-003 01/01/2019

AMADOR (South of San Joaquin River) and ALPINE COUNTIES

	Rates	Fringes
PLUMBER.....	\$ 42.25	30.64

-----  
PLUM0447-001 07/01/2017

AMADOR (north of San Joaquin River), EL DORADO (excluding Lake  
Tahoe area), NEVADA (excluding Lake Tahoe area); PLACER  
(excluding Lake Tahoe area), SACRAMENTO AND YOLO COUNTIES

	Rates	Fringes
PLUMBER/PIPEFITTER		
Journeyman.....	\$ 48.37	24.00
Light Commercial Work.....	\$ 36.23	17.72

-----  
ROOF0081-006 08/01/2018

MARIN, NAPA, SOLANO AND SONOMA COUNTIES

	Rates	Fringes
Rofer.....	\$ 39.40	17.58

-----  
ROOF0081-007 08/01/2018

ALPINE, BUTTE, COLUSA, EL DORADO, GLENN, LASSEN, MODOC, NEVADA,  
PLACER, PLUMAS, SACRAMENTO, SHASTA, SIERRA, SISKIYOU, SUTTER,  
TEHAMA, TRINITY, YOLO, AND YUBA COUNTIES

	Rates	Fringes
Rofer.....	\$ 36.57	18.23

-----  
SFCA0483-003 07/01/2018

MARIN, NAPA, SOLANO AND SONOMA COUNTIES

	Rates	Fringes
--	-------	---------

SPRINKLER FITTER (Fire  
Sprinklers).....\$ 63.87 30.62

-----  
SFCA0669-003 04/01/2017

ALPINE, BUTTE, COLUSA, EL DORADO, GLENN, LASSEN, MODOC, NEVADA,  
PLACER, PLUMAS, SACRAMENTO, SHASTA, SIERRA, SISKIYOU, SUTTER,  
TEHAMA, TRINITY, YOLO AND YUBA COUNTIES

	Rates	Fringes
SPRINKLER FITTER.....	\$ 37.20	15.84

-----  
SHEE0104-006 07/02/2018

MARIN, NAPA, SOLANO SONOMA & TRINITY COUNTIES

	Rates	Fringes
Sheet Metal Worker Mechanical Contracts \$200,000 or less.....	\$ 51.87	37.19
All other work.....	\$ 59.11	38.54

-----  
SHEE0104-009 07/01/2018

AMADOR, COLUSA, EL DORADO, NEVADA, PLACER, SACRAMENTO, SUTTER,  
YOLO AND YUBA COUNTIES

	Rates	Fringes
SHEET METAL WORKER.....	\$ 42.91	34.45

-----  
SHEE0104-010 07/01/2018

ALPINE COUNTY

	Rates	Fringes
SHEET METAL WORKER.....	\$ 40.34	32.80

-----  
SHEE0104-011 07/01/2018

BUTTE, COLUSA, EL DORADO, GLENN, LASSEN, MODOC, NEVADA, PLACER,  
PLUMAS, SACRAMENTO, SHASTA, SIERRA, SISKIYOU, SUTTER, TEHAMA,  
YOLO AND YUBA COUNTIES

	Rates	Fringes
Sheet Metal Worker (Metal decking and siding only).....	\$ 39.93	32.70

-----  
SHEE0104-014 07/01/2017

MARIN, NAPA, SOLANO, SONOMA AND TRINITY COUNTIES

	Rates	Fringes
SHEET METAL WORKER (Metal Decking and Siding only).....	\$ 37.53	32.10

-----  
SHEE0104-019 07/01/2018

BUTTE, GLENN, LASSEN, MODOC, PLUMAS, SHASTA, SIERRA, SISKIYOU AND TEHAMA COUNTIES

	Rates	Fringes
SHEET METAL WORKER		
Mechanical Jobs \$200,000 & under.....	\$ 32.21	32.29
Mechanical Jobs over \$200,000.....	\$ 42.91	34.43

-----  
TEAM0094-001 07/01/2018

	Rates	Fringes
Truck drivers:		
GROUP 1.....	\$ 31.68	27.86
GROUP 2.....	\$ 31.98	27.86
GROUP 3.....	\$ 32.28	27.86
GROUP 4.....	\$ 32.63	27.86
GROUP 5.....	\$ 32.98	27.86

FOOTNOTES:

Articulated dump truck; Bulk cement spreader (with or without auger); Dumpcrete truck; Skid truck (debris box); Dry pre-batch concrete mix trucks; Dumpster or similar type; Slurry truck: Use dump truck yardage rate.  
Heater planer; Asphalt burner; Scarifier burner; Industrial lift truck (mechanical tailgate); Utility and clean-up truck: Use appropriate rate for the power unit or the equipment utilized.

TRUCK DRIVER CLASSIFICATIONS

GROUP 1: Dump trucks, under 6 yds.; Single unit flat rack (2-axle unit); Nipper truck (when flat rack truck is used appropriate flat rack shall apply); Concrete pump truck (when flat rack truck is used appropriate flat rack shall apply); Concrete pump machine; Fork lift and lift jitneys; Fuel and/or grease truck driver or fuel person; Snow buggy; Steam cleaning; Bus or personhaul driver; Escort or pilot car driver; Pickup truck; Teamster oiler/greaser and/or serviceperson; Hook tender (including loading and unloading); Team driver; Tool room attendant (refineries)

GROUP 2: Dump trucks, 6 yds. and under 8 yds.; Transit mixers, through 10 yds.; Water trucks, under 7,000 gals.; Jetting trucks, under 7,000 gals.; Single-unit flat rack (3-axle unit); Highbed heavy duty transport; Scissor truck; Rubber-tired muck car (not self-loaded); Rubber-tired truck jumbo; Winch truck and "A" frame drivers; Combination winch

truck with hoist; Road oil truck or bootperson;  
Buggymobile; Ross, Hyster and similar straddle carriers;  
Small rubber-tired tractor

GROUP 3: Dump trucks, 8 yds. and including 24 yds.; Transit mixers, over 10 yds.; Water trucks, 7,000 gals. and over; Jetting trucks, 7,000 gals. and over; Vacuum trucks under 7500 gals. Trucks towing tilt bed or flat bed pull trailers; Lowbed heavy duty transport; Heavy duty transport tiller person; Self-propelled street sweeper with self-contained refuse bin; Boom truck - hydro-lift or Swedish type extension or retracting crane; P.B. or similar type self-loading truck; Tire repairperson; Combination bootperson and road oiler; Dry distribution truck (A bootperson when employed on such equipment, shall receive the rate specified for the classification of road oil trucks or bootperson); Ammonia nitrate distributor, driver and mixer; Snow Go and/or plow

GROUP 4: Dump trucks, over 25 yds. and under 65 yds.; Water pulls - DW 10's, 20's, 21's and other similar equipment when pulling Aqua/pak or water tank trailers; Helicopter pilots (when transporting men and materials); Lowbedk Heavy Duty Transport up to including 7 axles; DW10's, 20's, 21's and other similar Cat type, Terra Cobra, LeTourneau Pulls, Tournorocker, Euclid and similar type equipment when pulling fuel and/or grease tank trailers or other miscellaneous trailers; Vacuum Trucks 7500 gals and over and truck repairman

GROUP 5: Dump trucks, 65 yds. and over; Holland hauler; Low bed Heavy Duty Transport over 7 axles

-----  
WELDERS - Receive rate prescribed for craft performing operation to which welding is incidental.  
=====

Note: Executive Order (EO) 13706, Establishing Paid Sick Leave for Federal Contractors applies to all contracts subject to the Davis-Bacon Act for which the contract is awarded (and any solicitation was issued) on or after January 1, 2017. If this contract is covered by the EO, the contractor must provide employees with 1 hour of paid sick leave for every 30 hours they work, up to 56 hours of paid sick leave each year. Employees must be permitted to use paid sick leave for their own illness, injury or other health-related needs, including preventive care; to assist a family member (or person who is like family to the employee) who is ill, injured, or has other health-related needs, including preventive care; or for reasons resulting from, or to assist a family member (or person who is like family to the employee) who is a victim of, domestic violence, sexual assault, or stalking. Additional information on contractor requirements and worker protections under the EO is available at [www.dol.gov/whd/govcontracts](http://www.dol.gov/whd/govcontracts).

Unlisted classifications needed for work not included within the scope of the classifications listed may be added after



award only as provided in the labor standards contract clauses (29CFR 5.5 (a) (1) (ii)).

-----

The body of each wage determination lists the classification and wage rates that have been found to be prevailing for the cited type(s) of construction in the area covered by the wage determination. The classifications are listed in alphabetical order of "identifiers" that indicate whether the particular rate is a union rate (current union negotiated rate for local), a survey rate (weighted average rate) or a union average rate (weighted union average rate).

#### Union Rate Identifiers

A four letter classification abbreviation identifier enclosed in dotted lines beginning with characters other than "SU" or "UAVG" denotes that the union classification and rate were prevailing for that classification in the survey. Example: PLUM0198-005 07/01/2014. PLUM is an abbreviation identifier of the union which prevailed in the survey for this classification, which in this example would be Plumbers. 0198 indicates the local union number or district council number where applicable, i.e., Plumbers Local 0198. The next number, 005 in the example, is an internal number used in processing the wage determination. 07/01/2014 is the effective date of the most current negotiated rate, which in this example is July 1, 2014.

Union prevailing wage rates are updated to reflect all rate changes in the collective bargaining agreement (CBA) governing this classification and rate.

#### Survey Rate Identifiers

Classifications listed under the "SU" identifier indicate that no one rate prevailed for this classification in the survey and the published rate is derived by computing a weighted average rate based on all the rates reported in the survey for that classification. As this weighted average rate includes all rates reported in the survey, it may include both union and non-union rates. Example: SULA2012-007 5/13/2014. SU indicates the rates are survey rates based on a weighted average calculation of rates and are not majority rates. LA indicates the State of Louisiana. 2012 is the year of survey on which these classifications and rates are based. The next number, 007 in the example, is an internal number used in producing the wage determination. 5/13/2014 indicates the survey completion date for the classifications and rates under that identifier.

Survey wage rates are not updated and remain in effect until a new survey is conducted.

#### Union Average Rate Identifiers

Classification(s) listed under the UAVG identifier indicate that no single majority rate prevailed for those

classifications; however, 100% of the data reported for the classifications was union data. EXAMPLE: UAVG-OH-0010 08/29/2014. UAVG indicates that the rate is a weighted union average rate. OH indicates the state. The next number, 0010 in the example, is an internal number used in producing the wage determination. 08/29/2014 indicates the survey completion date for the classifications and rates under that identifier.

A UAVG rate will be updated once a year, usually in January of each year, to reflect a weighted average of the current negotiated/CBA rate of the union locals from which the rate is based.

---

WAGE DETERMINATION APPEALS PROCESS

1.) Has there been an initial decision in the matter? This can be:

- \* an existing published wage determination
- \* a survey underlying a wage determination
- \* a Wage and Hour Division letter setting forth a position on a wage determination matter
- \* a conformance (additional classification and rate) ruling

On survey related matters, initial contact, including requests for summaries of surveys, should be with the Wage and Hour Regional Office for the area in which the survey was conducted because those Regional Offices have responsibility for the Davis-Bacon survey program. If the response from this initial contact is not satisfactory, then the process described in 2.) and 3.) should be followed.

With regard to any other matter not yet ripe for the formal process described here, initial contact should be with the Branch of Construction Wage Determinations. Write to:

Branch of Construction Wage Determinations  
Wage and Hour Division  
U.S. Department of Labor  
200 Constitution Avenue, N.W.  
Washington, DC 20210

2.) If the answer to the question in 1.) is yes, then an interested party (those affected by the action) can request review and reconsideration from the Wage and Hour Administrator (See 29 CFR Part 1.8 and 29 CFR Part 7). Write to:

Wage and Hour Administrator  
U.S. Department of Labor  
200 Constitution Avenue, N.W.  
Washington, DC 20210

The request should be accompanied by a full statement of the interested party's position and by any information (wage payment data, project description, area practice material, etc.) that the requestor considers relevant to the issue.

3.) If the decision of the Administrator is not favorable, an interested party may appeal directly to the Administrative Review Board (formerly the Wage Appeals Board). Write to:

Administrative Review Board  
U.S. Department of Labor  
200 Constitution Avenue, N.W.  
Washington, DC 20210

4.) All decisions by the Administrative Review Board are final.

=====

END OF GENERAL DECISION



REVISION	
NUMBER	DATE
1	02/21/19
ADDENDUM #1 - QUADRANTAL REVISIONS	
DWH	
BY	

DESIGNED BY: DWH	DATE: 07/18/18
CHECKED BY: DWH	DATE: 07/18/18
ROAD NUMBER: 023	

REGISTERED PROFESSIONAL ENGINEER DUSTIN W. HARRINGTON No. C71517 License Expires 12-31-19 State of California	PREPARED UNDER THE SUPERVISION OF:  REGISTERED CIVIL ENGINEER DATE: 01/29/19
---	---

DESIGNED BY: DWH	DATE: 07/18/18
CHECKED BY: DWH	DATE: 07/18/18
ROAD NUMBER: 023	

REGISTERED PROFESSIONAL ENGINEER DUSTIN W. HARRINGTON No. C71517 License Expires 12-31-19 State of California	PREPARED UNDER THE SUPERVISION OF:  REGISTERED CIVIL ENGINEER DATE: 01/29/19
---	---

DESIGNED BY: DWH	DATE: 07/18/18
CHECKED BY: DWH	DATE: 07/18/18
ROAD NUMBER: 023	

REGISTERED PROFESSIONAL ENGINEER DUSTIN W. HARRINGTON No. C71517 License Expires 12-31-19 State of California	PREPARED UNDER THE SUPERVISION OF:  REGISTERED CIVIL ENGINEER DATE: 01/29/19
---	---

DESIGNED BY: DWH	DATE: 07/18/18
CHECKED BY: DWH	DATE: 07/18/18
ROAD NUMBER: 023	

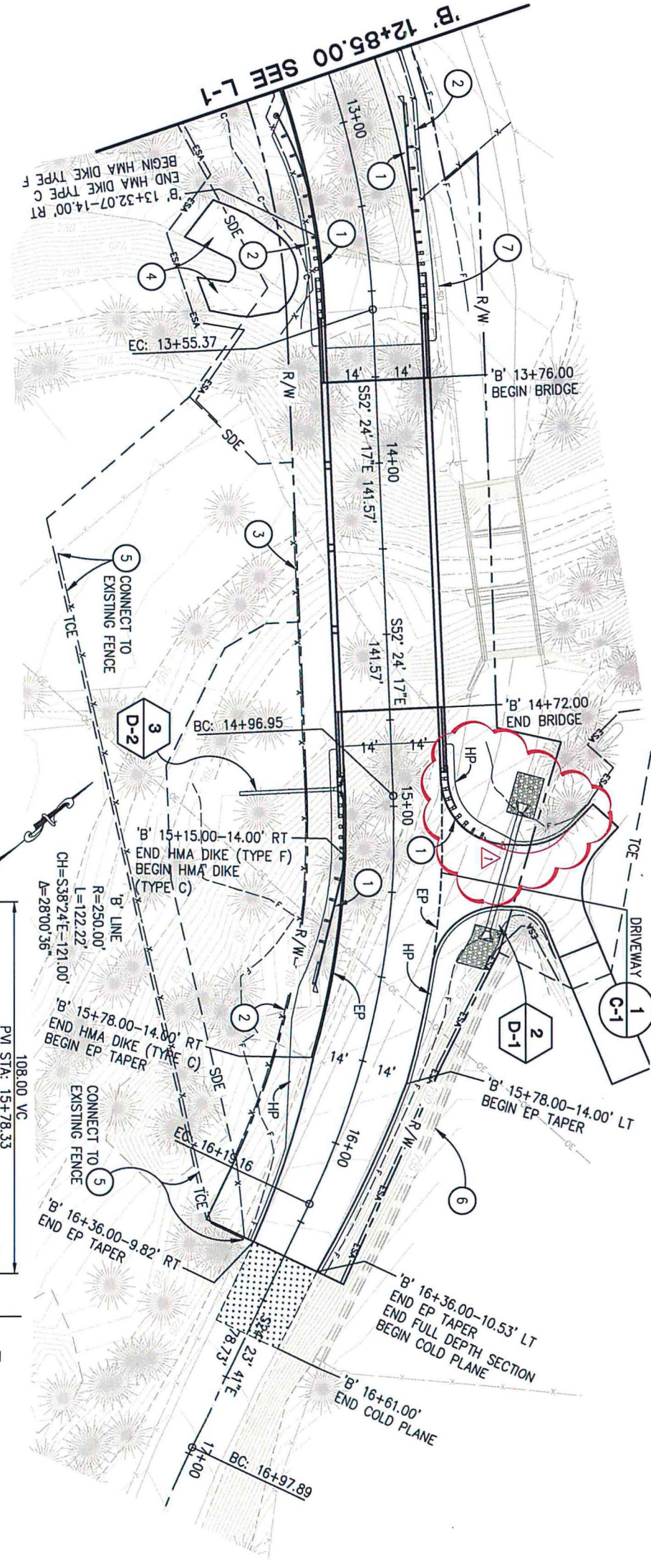
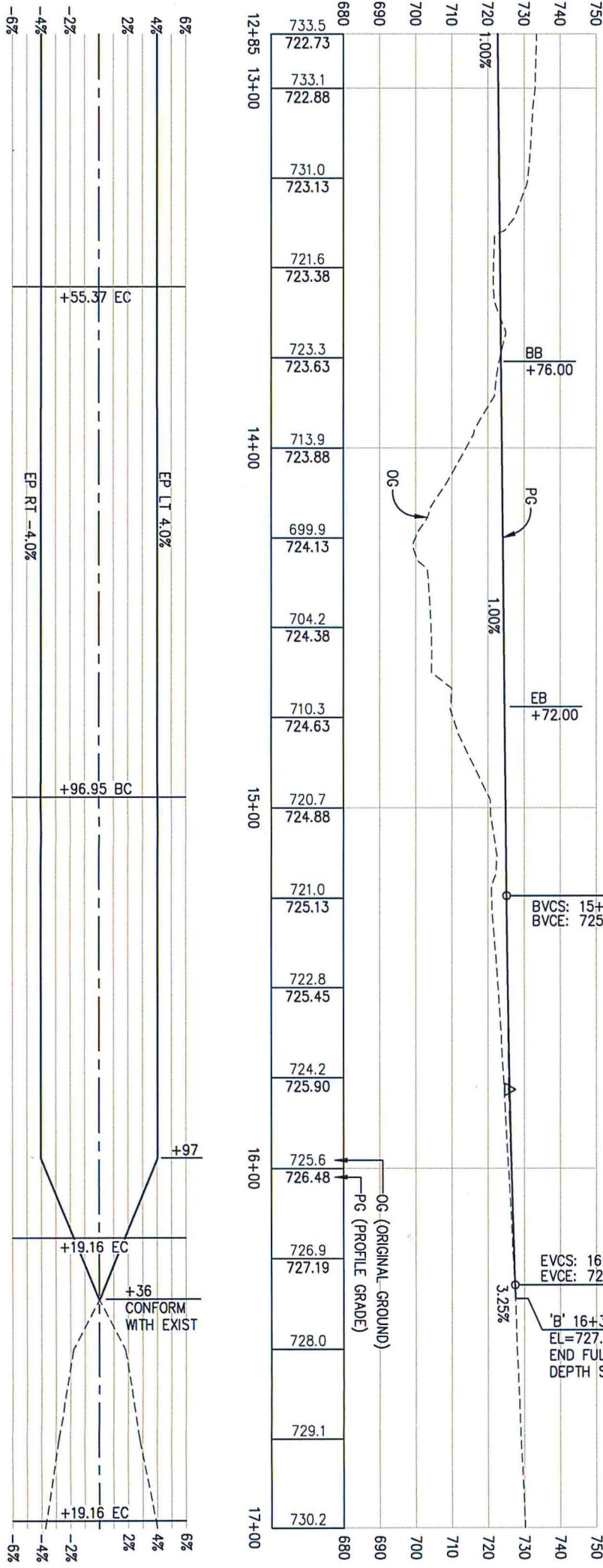

**CONSTRUCTION NOTES:**

- 1 - MGS, SEE SHT C-2
- 2 - FENCE, SEE SHT C-2
- 3 - GATE, SEE SHT C-2
- 4 - REGRADE DRIVEWAY/PATH AREA TO ALLOW A SMALL VEHICLE (GOLF CART, 4 WHEELER, ETC.) TO NEGOTIATE CURVE
- 5 - TEMPORARY FENCE (TYPE WM), PER A86
- 6 - PROTECT EXISTING STONE WALL IN PLACE
- 7 - REMOVE 18"± OF 8" RCP

**LEGEND:**

- CSA — TEMPORARY HIGH VISIBILITY FENCE

SCALE : 1" = 20' H/V

BASSI RD AT GRANITE CREEK  
BRIDGE REPLACEMENT

COUNTY OF EL DORADO  
DEPARTMENT OF TRANSPORTATION



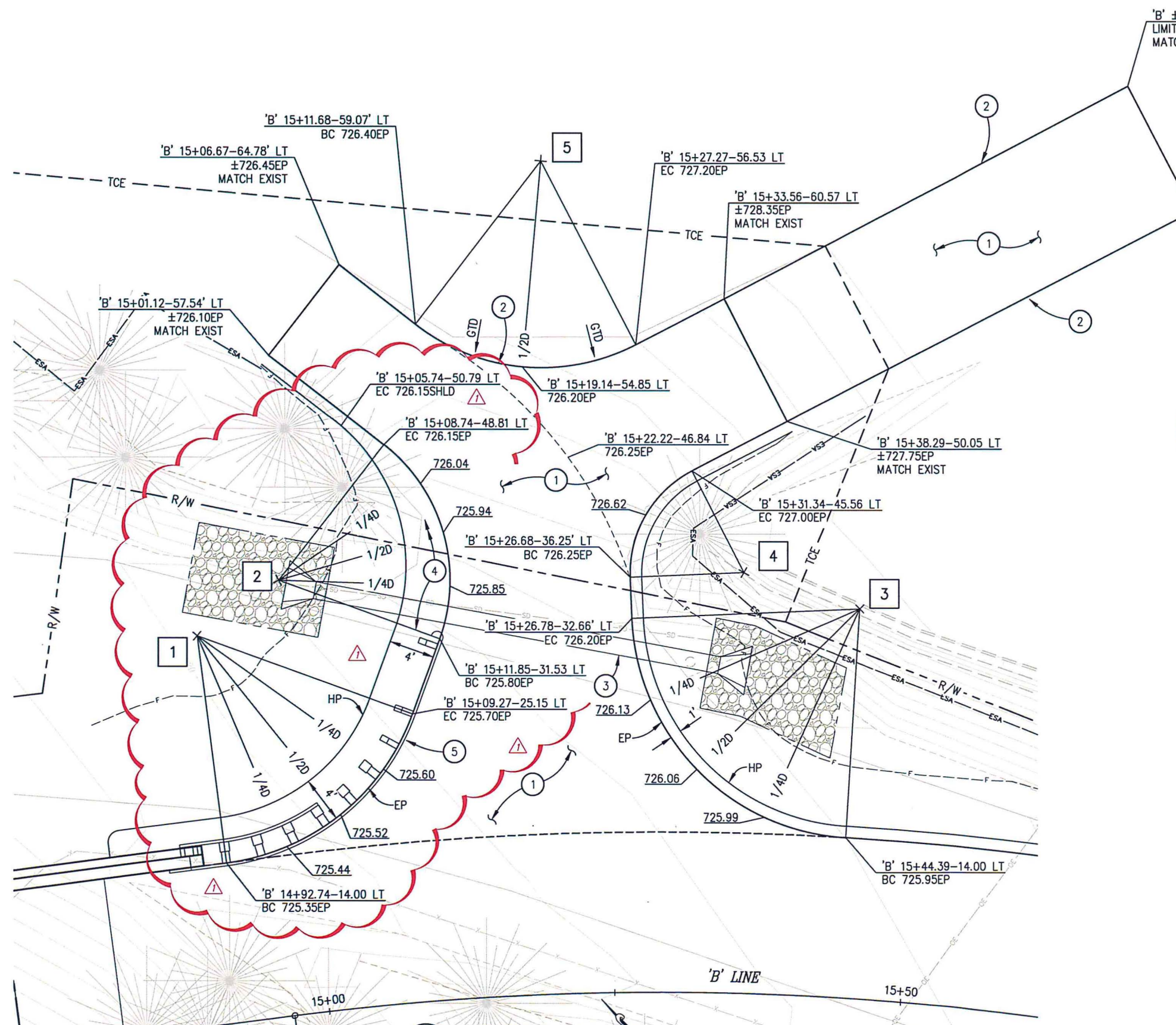

REVISION	
NUMBER	DATE
1	02/21/19
ADDENDUM #1 - QUADRANTAL REVISIONS	
DWH	
BY	

ORIGINAL SCALE IS IN INCHES  
 FOR REDUCED PLANS  
 2  
 1  
 0  
 Drawing name: C:\Civil\_3D Projects\77128 Bassi Rd at Granite Cr.\CADD Files\During Construction\C-1R.dwg Layout Tab: C-1 Feb 21, 2019 - 8:21am SmeVey



DWY 1 CURVE RETURN DATA					
REFERENCE NUMBER	LOCATION	LENGTH	RADIUS	DELTA	CHORD
1	'B' 14+92.74-34.00 Lt	21.88	20	62°40'39"	S83°44'36"E 20.80
2	'B' 14+99.94-37.93 Lt	18.88	15	72°06'57"	N28°51'36"E 17.66
3	'B' 15+44.39-34.00 Lt	29.37	20	84°08'21"	N00°32'15"E 26.80
4	'B' 15+35.39-36.74 Lt	11.37	10	65°09'03"	N75°10'57"E 10.77
5	'B' 15+35.39-36.74 Lt	20.43	18	65°02'39"	N39°43'12"E 19.35

**CONSTRUCTION NOTES:**

- ① - 2.5" HMA OVER 4" AB (CLASS 2).
- ② - PLACE SHOULDER BACKING ALONG DRIVEWAYS AS NEEDED
- ③ - 18" STORM DRAIN, SEE 
- ④ - TRANSITION SHOULDER  
 'B' 15+08.62-33.18 LT = 4'  
 'B' 15+05.74-50.79 LT = 1'
- ⑤ - FOR GUARDRAIL PLACEMENT SEE SHT C-2

**ABBREVIATIONS:**

GTD - GRADE TO DRAIN

**1 DWY 1**  
**C-1** SCALE: 1"=5'

**CONSTRUCTION DETAILS**  
 SCALE : AS SHOWN

REVISION	NUMBER	DATE	DESCRIPTION	BY
	1	02/22/19	ADDENDUM #1-GUARDRAIL REVISIONS	DWH

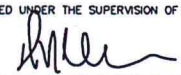

PREPARED UNDER THE SUPERVISION OF:  
  
 REGISTERED CIVIL ENGINEER  
 DATE: 01/29/19

DESIGNED: DWH  
 DRAWN: SGM  
 CHECKED: DWH  
 DATE: 07/09/18  
 ROAD NUMBER: 023



**COUNTY OF EL DORADO**  
**DEPARTMENT OF TRANSPORTATION**

**BASSI RD AT GRANITE CREEK**  
**BRIDGE REPLACEMENT**

SHEET   
 6 OF 41  
 W.D. No. 77128

ORIGINAL SCALE IS IN INCHES  
 Drawing name: C:\Civil 3D\Projects\77128 Bassi Rd at Granite Creek\Construction\C-2R.dwg Layout Tab: C-2R Feb 21, 2019 - 1:21pm SMCVey

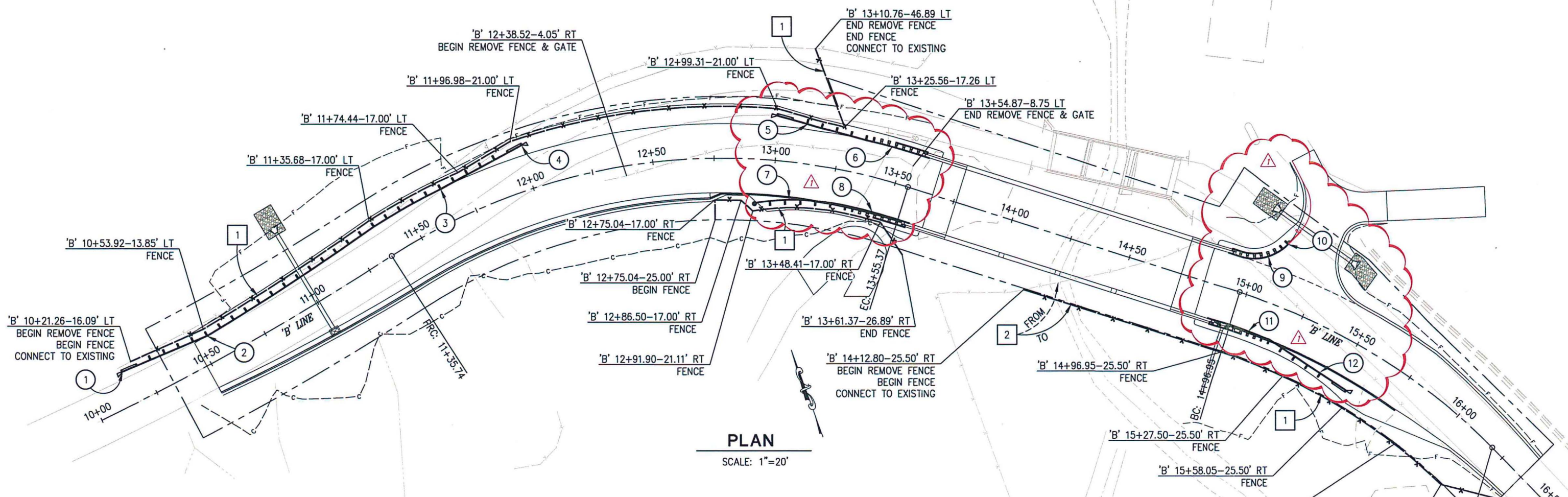

**GUARDRAIL (MGS) GENERAL NOTES:**

1. STATIONS AND OFFSETS ARE TO CENTER OF POST AT OUTSIDE FACE OF RAIL ELEMENT
2. APPLY STAIN TO GALVANIZED SURFACES OF ALL MGS (WOOD POST), TRANSITION RAILING (TYPE WB-31), AND TERMINAL SYSTEMS

**GUARDRAIL (MGS) CONSTRUCTION NOTES:**

- |  |   |
|--|---|
| <p>① - 'B' 10+16.24-13.80 LT BEGIN MGS FLARED TERMINAL SYSTEM (37'-6" TL-3 TYPE) PER A77P2</p> <p>② - 'B' 10+54.04-10.60 LT END TERMINAL SYSTEM BEGIN MGS</p> <p>③ - 'B' 11+65.64-13.75 LT END MGS BEGIN MGS FLARED TERMINAL SYSTEM (37'-6" TL-3 TYPE) PER A77P2</p> <p>④ - 'B' 12+00.75-18.02 LT END TERMINAL SYSTEM</p> <p>⑤ - MGS FLARED TERMINAL SYSTEM (37'-6" TL-3 TYPE) PER A77Q4</p> <p>⑥ - TRANSITION RAILING, TYPE WB-31 PER A77U4</p> | <p>⑦ - MGS FLARED TERMINAL SYSTEM (37'-6" TL-3 TYPE) W/ 30" RAIL OFFSET AT TERMINAL END PER A77Q1</p> <p>⑧ - TRANSITION RAILING, TYPE WB-31 PER A77U4</p> <p>⑨ - THREE BEAM BARRIER TRANSITION RAILING (TYPE STB) PER A78J, (R=20')</p> <p>⑩ - THREE BEAM END ANCHOR ASSEMBLY (DEPARTURE END) PER A78E1 W/ TYPE 'TA' END CAP</p> <p>⑪ - TRANSITION RAILING, TYPE WB-31 PER A77U4</p> <p>⑫ - MGS FLARED TERMINAL SYSTEM (37'-6" TL-3 TYPE) PER A77Q4</p> |
|--|---|

**FENCE CONSTRUCTION NOTES:**

- 1 - FENCE (TYPE WM, METAL POST) PER A86
- 2 - RELOCATE CUSTOM GATE AT CREEK CROSSING, REPLACE PARTS AS NECESSARY TO RESTORE FULL FUNCTIONALITY

**CONSTRUCTION DETAILS-GUARDRAIL AND FENCING PLAN**  
 SCALE : AS SHOWN

REVISION	NUMBER	DATE	DESCRIPTION	BY
	1	02/21/19	ADDENDUM #1-GUARDRAIL REVISIONS	DWH



PREPARED UNDER THE SUPERVISION OF:  
*Dustin W. Harrington*  
 REGISTERED CIVIL ENGINEER  
 DATE: 01/29/19

DESIGNED: DWH  
 DRAWN: SGM  
 CHECKED: DWH  
 DATE: 07/09/18  
 ROAD NUMBER: 023



**COUNTY OF EL DORADO**  
**DEPARTMENT OF TRANSPORTATION**

**BASSI RD AT GRANITE CREEK**  
**BRIDGE REPLACEMENT**

SHEET  
**C-2 R**  
 7 OF 41  
 W.D. No. 77128

ORIGINAL SCALE IS IN INCHES  
 Drawing name: C:\Civil 3D Projects\77128 Bassi Rd at Granite Cr\CADD Files\Sheets\0-Sheets.dwg Layout Tab: D-2 Feb 21, 2019 - 9:30am SMC/ky  
 FOR REDUCED PLANS

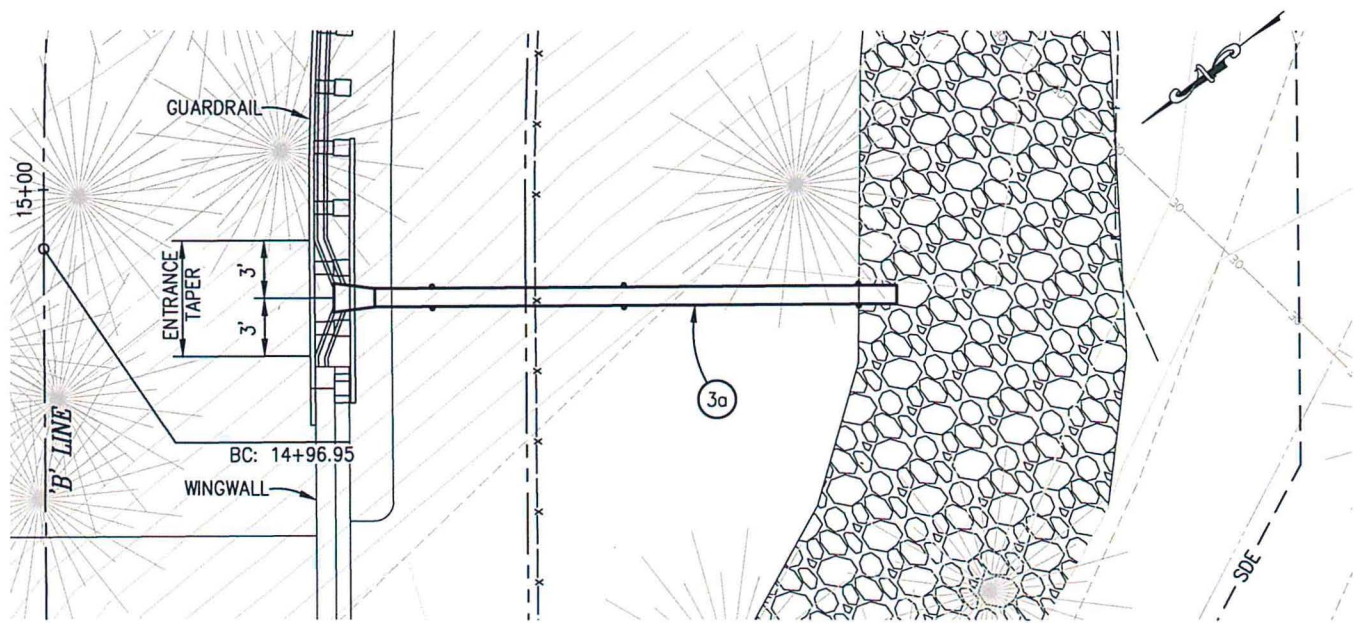

**SD SYSTEM 3-PLAN**  
SCALE: 1"=5'

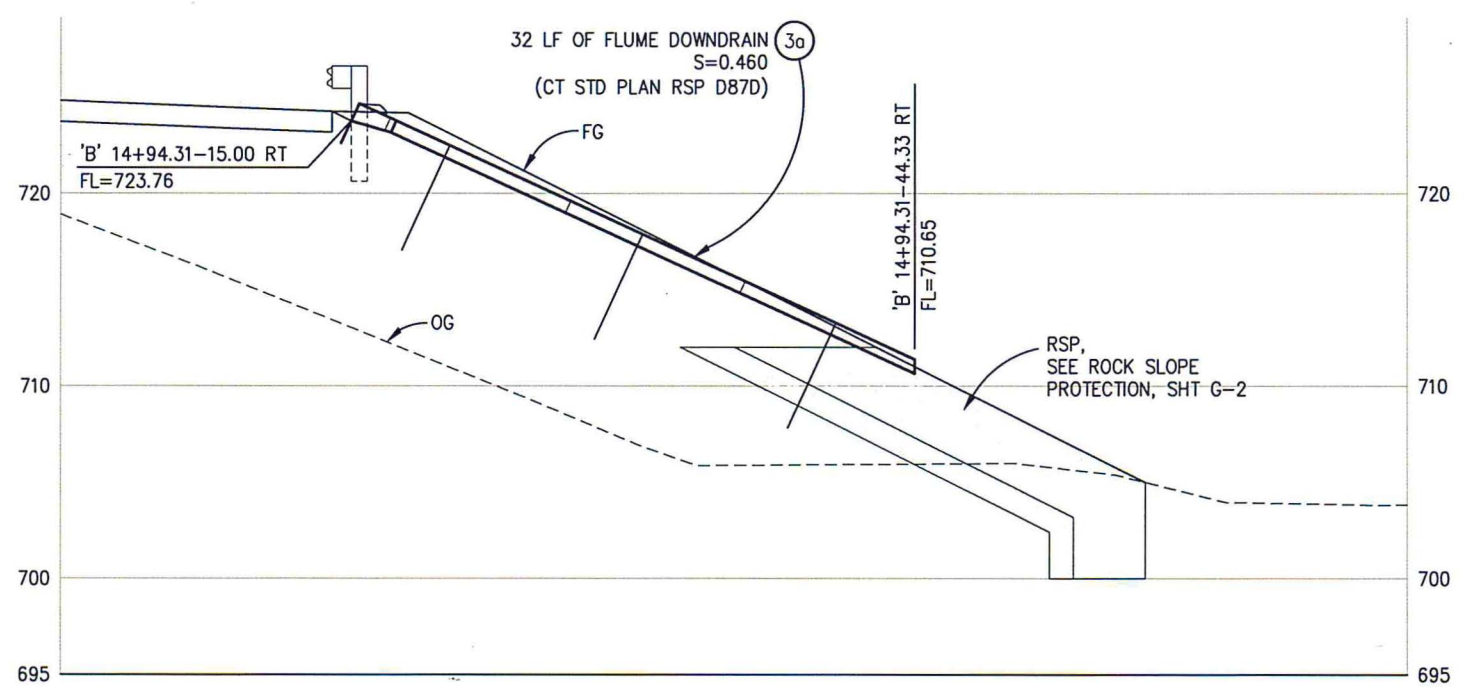

**SD SYSTEM 3-PROFILE**  
SCALE: 1"=5' H,V

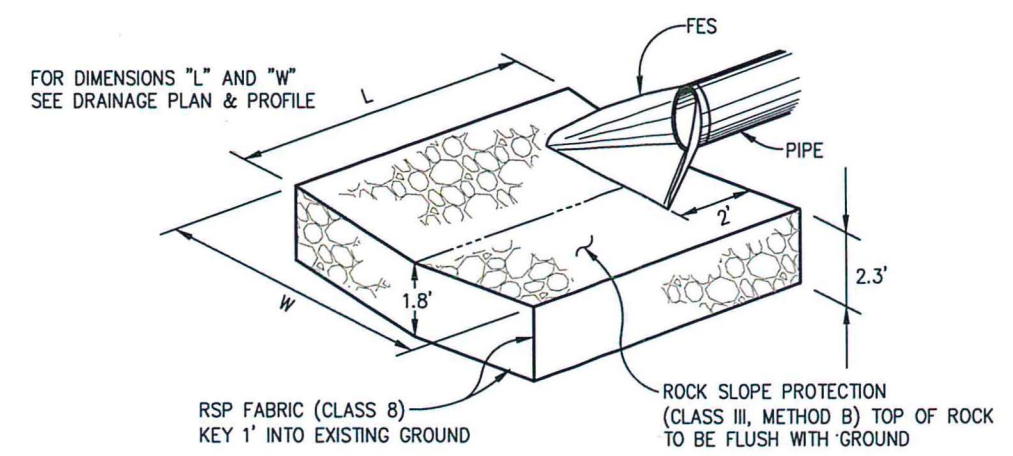

**ROCK ENERGY DISSIPATOR**  
NTS

DRAINAGE PLAN SHEET NO.	DRAINAGE SYSTEM NO.	DRAINAGE UNIT	DI (TYPE G3)	H INLET DEPTH [N]	18" PLASTIC PIPE	18" FES (CONCRETE)	FLUME DOWNDRAIN	RSP (CLASS III, METHOD B)	RSP FABRIC (CLASS 8)	REMOVE 12" CSP	DESCRIPTION	STATION	DRAINAGE UNIT	DRAINAGE SYSTEM NO.	DRAINAGE PLAN SHEET NO.	
			EA	FT	FT	EA	LF	CY	SY	FT						
D-1	1	a						8	21				a	1	D-1	
		b				1						'B' 11+00.00-32.95 LT	b			
		c			46							S=0.125	c			
		d	1	6.0								TYPE 24-12 GRATE	'B' 11+00.00-14.65 RT			d
D-1	2	a								43			a	2	D-1	
		b						8	21				b			
		c				1							'B' 15+02.58-36.71 LT			c
		d			36							S=0.058	d			
		e				1							'B' 15+33.64-28.60 LT			e
		f						8	21							f
D-2	3	a				32						a	3	D-2		
TOTAL			1		82	3	32	24	63	43						

NOTES:  
1. [N] NOT A SEPARATE PAY ITEM, FOR INFORMATION ONLY.

DRAINAGE DETAILS AND QUANTITIES  
SCALE : NONE

REVISION	NUMBER	DATE	DESCRIPTION	BY
	1	02/21/19	ADDENDUM #1-FES MATERIAL REVISION	DWH



PREPARED UNDER THE SUPERVISION OF:  
  
 REGISTERED CIVIL ENGINEER  
 DATE: 01/29/19

DESIGNED: DWH  
 DRAWN: SGM  
 CHECKED: DWH  
 DATE: 07/19/18  
 ROAD NUMBER: 023



COUNTY OF EL DORADO  
DEPARTMENT OF TRANSPORTATION

BASSI RD AT GRANITE CREEK  
BRIDGE REPLACEMENT

SHEET  
D-2  
12 OF 41  
W.O. No. 77128