



COMMUNITY DEVELOPMENT AGENCY

TRANSPORTATION DIVISION

<http://www.edcgov.us/DOT/>

PLACERVILLE OFFICES:

MAIN OFFICE:
2850 Fairlane Court, Placerville, CA 95667
(530) 621-5900 / (530) 626-0387 Fax

CONSTRUCTION & MAINTENANCE:
2441 Headington Road, Placerville, CA 95667
(530) 642-4909 / (530) 642-0508 Fax

LAKE TAHOE OFFICES:

ENGINEERING:
924 B Emerald Bay Road, South Lake Tahoe, CA 96150
(530) 573-7900 / (530) 541-7049 Fax

MAINTENANCE:
1121 Shakori Drive, South Lake Tahoe, CA 96150
(530) 573-3180 / (530) 577-8402 Fax

DATE: August 21, 2013

TO: All Prospective Bidders

SUBJECT: Addendum No. 1
U.S. 50/Silva Valley Interchange
PW 12-30647, CIP No. 71328

Submit proposals for this work with the understanding and full consideration of this addendum. The revisions declared in this addendum are essential parts of the Contract.

ITEM NO.	LOCATION, PAGE, OR DRAWING NO.	DESCRIPTION OF CHANGE
1. 1.	N-3	Refer Response to Bidders' Inquiries No. 3 Item 3.30. Add to the end of OBTAINING OR INSPECTING CONTRACT DOCUMENTS in the Notice to Bidders: "Email with the completed Electronic File Usage Acknowledgment Form requests for electronic files of the existing and proposed contours in AutoCAD (.dwg) format to Janel.Gifford@edcgov.us . Once the signed Electronic File Usage Acknowledgment Form is received the County will email the files to the email address shown on the Electronic File Usage Acknowledgment Form." The Electronic File Usage Acknowledgment Form is attached to this Addendum as Attachment A .
1. 2.	SP-2	Replace the definition of "Department" with: " Department: The Transportation Division in the Community Development Agency of the County of El Dorado or Department of Transportation as defined in St & Hwy Code § 20 and authorized in St & Hwy Code § 90; its authorized representatives."
1. 3.	SP-5	Change "Delete the 3 rd paragraph of section 2-1.33C" to " Delete the 3rd paragraph of section 2-1.33A. "
1. 4.	SP-6	Add " If using a Bidders' Bond, " to the beginning of the change shown on SP-6 for " Replace the last paragraph of section 2-1.34 with: ".

1. 5.	TOC-1 and SP-12	Delete the following from the Table of Contents and SP-12: <p style="text-align: center;">“4 SCOPE OF WORK”</p> Delete the following from SP-12: <p style="text-align: center;">“Delete section 4-1.07.”</p>
1. 6.	SP-18	After the change to section 5-1.32 on SP-18 add: <p style="text-align: center;">“Add to the list in the 1st paragraph of section 5-1.36A:</p> 10. Survey monuments”
1. 7.	SP-19	After the second table on SP-19 add: <p style="text-align: center;">“Add to section 5-1.36:</p> 5-1.36E Survey Monuments Protect survey monuments on and off the highway. Upon discovery of a survey monument not identified and located immediately: <ol style="list-style-type: none"> 1. Stop work near the monument 2. Notify the Engineer Do not resume work near the monument until authorized.”
1. 8.	SP-22	Add between the second and third paragraphs on SP-22: <p style="text-align: center;">“Replace “\$50” in the 1st sentence in the 6th paragraph of section 7-1.02K(2) with:</p> \$200 <p style="text-align: center;">Replace “\$25” in the 2nd sentence in the 13th paragraph of section 7-1.02K(3) with:</p> \$100”
1. 9.	SP-26	Change “Office Engineer” in the first sentence of 7-1.06 C to “Community Development Agency, Contract Services Unit, 2850 Fairlane Court, Placerville, CA 95667.”
1. 10.	SP-42	Add to the 7 th paragraph on SP-42: “Only your operations will cause the need for temporary access control fence. Installation and removal of temporary access control fence is at your expense.”
1. 11.	SP-52	In the 8 th and 9 th paragraphs of SP-52 delete “When work requiring reversing control is in progress.” Add “when work requiring reversing control is in progress.” to the end of the first sentence of each of these paragraphs.
1. 12.	SP-54	Add “dated 10-19-12” to the end of “Add between the 3rd and 4th paragraphs of the RSS for section 12-4.03” . Add “dated 10-19-12” to the end of “Replace the 4th paragraph of the RSS for section 12-4.03” .

1. 13.	SP-67	After the second paragraph on SP-67 add: “Add to item 4 of the 4th paragraph of section 13-3.01b(2)(a): Copy of County-furnished CEQA document.”
1. 14.	SP-79	Add to section 19 on SP-79: “Add section 19-2.04: On a parcel acquired for the project on Joerger Cut-off Road there is a significant amount of rock of varying sizes which you must reuse on the project or remove. Reusing or removing this rock is paid under Roadway Excavation.”
1. 15.	SP-108 and Plan sheet 138	Refer to Response to Bidders’ Inquiries No. 3, Item 3.12. Replace section 51-8 with Attachment B of this Addendum.
1. 16.	SP-111	Refer to Response to Bidder’s Inquiries No. 3 Item 3.21 Replace section 51-8 with Attachment B of this Addendum.
1. 17.	Appendix B	Delete “PLACEHOLDER” from the last page of Appendix B and add to the end of Appendix B Caltrans Encroachment Permit attached as Attachment C to this Addendum.
1. 18.	Agreement	Throughout the Agreement replace “Department of Transportation” with “Community Development Agency, Transportation Division”. On the signature page of the Agreement, in the “NOTE” paragraph replace “Department” with “County”.
1. 19.	Agreement C-3	In Article 2 of the Agreement add “Iran Contracting Act Certification” after “Noncollusion Affidavit”.
1. 20.	Proposal pages	The Proposal section (not including the Bidder’s Bond) is replaced in its entirety to address the following: <ul style="list-style-type: none"> • Response to Bidders’ Inquiries No. 1 Item 1.05; • Response to Bidders’ Inquiries No. 3, item 3.15 Question #2; • to replace “Department of Transportation” with “Community Development Agency, Transportation Division”; and • to add the Iran Contracting Act Certification. Bidders are instructed to attach the revised Proposal attached to this Addendum to page P-1 of the Proposal in the Contract Documents by stapling at the top of the documents. ”
1. 21.	Plan Sheets X-3 and Carson Creek MSE sheet 7	Refer to item 3.2 of Response to Bidders’ Inquiries No. 3. Add Note 8 to Carson Creek MSE sheet 7: “8. The Concrete Barrier Slab with Paving Notch detail does not apply to this project.”

1. 22.	Plan sheets 179 and 180	Bidders are instructed to replace Plan sheets 179 and 180 with revised Plan sheets 179 and 180 attached to this Addendum.
1. 23.	Plan sheets 267-272	The specifications for work on these plan sheets have been added as section 86-2.17 and are included in Attachment D to this Addendum.
1. 24.	SP-51	Under section 12-4.02A under "Special days are", delete "& October 5, 2014" and add ", October 5, 2014, & October 4, 2015". Also, delete "& May 3, 2014" and add ", May 3, 2014, & May 2, 2015".
1. 25.	SP-120 and SP-125	Under section 77-2.01B add "All tie-in work of the water lines (except on Church property), including the waterline on New Tong Road to the north of the church, must be completed within 4 consecutive hours from the start of the outage." Under section 77-3.01B delete "All tie-in work of the water lines (except on Church property), including the waterline on New Tong Road to the north of the church, must be completed within 4 consecutive hours from the start of the outage."
1. 26.	Plan sheet 340	Bidders are instructed to replace Plan sheet 340 with revised Plan sheet 340 attached to this Addendum.
1. 27.	SP-69	Add to the first sentence of Section 13-11.01C after "...in this Certification": "and to the California Department of Fish and Game before commencement of diversion." Add to the last sentence of Section 13-11.01C ", the Streambed Alteration Agreement, and the U.S. Fish and Wildlife Service requirements." Replace section 13-11.02 with "Any temporary dam or other artificial obstruction constructed must only be built from clean materials such as sandbags, gravel bags, water dams, port-a- dams, water bladder dams, K-rails, driven sheet metal coffer dams, or clean/washed gravel which will cause little or no siltation."

Indicate receipt of this addendum by filling in the number of this addendum in the space provided on the signature page of the proposal.

Holders who have already mailed their proposal can contact Janel Gifford at (email: Janel.Gifford@edcgov.us) to arrange return of their proposal.

Inform all suppliers and subcontractors as necessary.

The DOT is only sending this addendum by posting on the following website:
<http://www.edcgov.us/Government/DOT/Bids.aspx>.

If you are not a Contract Documents Holder, but request a set of documents to bid on this project, you must comply with the requirements of this addendum when submitting your bid.

Attachments:

Attachment A – Electronic File Usage Acknowledgment	1 page
Attachment B – Revised Section 51-8	10 pages
Caltrans Encroachment Permit – Attachment C	15 pages
Proposal	22 pages
Revised Plan sheets 179 and 180	2 pages
Attachment D - Section 86-2.17	9 pages
Revised Plan sheet 340	1 page

End of Addendum No. 1



Recommended by:
Janel Gifford, P.E.
Office Engineer



Date



Approved by:
Kimberly A. Kerr
Interim Transportation Director
Acting Community Development Agency Director

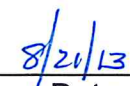

Date

ATTACHMENT A – ELECTRONIC USAGE FORM

**ELECTRONIC FILES USAGE ACKNOWLEDGMENT
US 50/Silva Valley Parkway Interchange - Phase 1
Contract No. PW 12-30647 / CIP No.71328**

Whereas, the party executing this Electronic Files Usage Acknowledgment (“Recipient”) has requested electronic copies of the contour files in AutoCAD format (.dwg) (“Electronic Files”) for the above-referenced project (“Project”) for purpose of preparing its bid.

Whereas, the County of El Dorado (“County”) has agreed to provide Recipient with the Electronic Files only upon Recipient’s acknowledgment of and agreement to abide by the terms and conditions contained herein.

Therefore, Recipient hereby acknowledges and agrees to abide by the following terms and conditions:

1. Recipient is authorized to use the Electronic Files for the sole purpose of preparing its proposal for the Project. Said Electronic Files are not to be used by Recipient for any other aspect of the Project nor for any other project. By providing Recipient with a copy of the Electronic Files, neither the County nor the design consultant grant Recipient any ownership or copyright in the Electronic Files. County and/or the design consultant shall be deemed the author(s) of the Electronic Files and will retain all common law, statutory, and other reserved rights, in addition to the copyrights.

2. It is Recipient’s responsibility to verify all aspects of the Electronic Files against the signed or sealed hard-copy construction documents. In the event of a conflict between the signed or sealed construction documents and the Electronic Files, the signed or sealed hard-copy construction documents shall govern.

3. Recipient releases the County and the design consultant, Mark Thomas & Company, Inc., from any liability arising from modifications to Electronic Files made by Recipient or its agents and for reuse of the files for any purpose other than the purposes stated herein.

Signature

Date

Printed Name

Company

Title

Method of Transmittal:

Email files to: _____

Add to section 51:
51-8 PRECAST BRIDGE SYSTEM

51-8.01 GENERAL

51-8.01A Summary

Work consists of installing the Precast Bridge System, masonry unit block walls with mechanically stabilized earth system (MSE system), RSP at wingwalls including rolled erosion control product (blanket) and sealant adhesive, cast-in-place concrete footings, and perforated wingwall drains. Where manufacturer's specifications conflict, the most stringent requirements must apply.

Precast elements must be designed to comply with the "Standard Specifications for Highway Bridges," 17th Edition, adopted by the American Association of State Highway and Transportation Officials, 2002.

51-8.01B Definitions

Not Used

51-8.01C Submittals

Submit shop drawings, design calculations, precast qualifications, and bridge installation and protection plan within ten (10) working days after the receipt of Notice of Award. Upon receipt of the Precast Bridge System submittal, Engineer must review and approve or request a revised submittal(s) within five (5) working days after the initial submittal(s). If corrections are required to the submittal, the Precast Bridge System manufacturer must remedy all corrections within five (5) working days and resubmit for Department approval.

You must submit shop drawings for all elements of the Precast Bridge System and cast-in-place foundations under these Special Provisions. The design drawings must be stamped by a licensed Professional Engineer registered in the State of California.

You must submit the design calculations for all elements of the Precast Bridge System and cast-in-place foundations under these Special Provisions. The calculations must be stamped by a licensed Professional Engineer registered in the State of California.

You must submit precaster qualifications in accordance with the Certification of Bidder's Precast Bridge Manufacturer's Qualifications attached to the Contractor's Bid Proposal, which demonstrate adherence to the standards set forth in the NPCA Quality Control Manual. The submittal must show that the precaster has met one or both of the following:

- Certified by the Precast/Prestressed Concrete Institute Plant Certification Program or the National Precast Concrete Association's Plant Certification Program before and during production of the elements of the bridge system.
- Has been in the business of producing precast concrete products similar to those specified for a minimum of 3 years. The precaster must maintain a permanent quality control department or retain an independent testing agency on a continuing basis. The agency must issue a report, certified by a licensed engineer, detailing the ability of the precaster to produce quality products consistent with industry standards.

You must submit a bridge installation and protection plan for Department review. The plan must comply with the manufacturer's specifications and include methods and sequence of all aspects of the bridge installation work including shoring, bracing, or laying back slopes, utility removal, excavation for bridge and wingwall footings, bridge installation, backfill, and proposed noticing of utility companies. These sequences must also be reflected in your schedule.

Precast element dimensions and reinforcement details must be shown on the plan and shop drawings prepared by the manufacturer and provided by you. The shop drawings must include design calculations as well as the minimum concrete compressive strength. The minimum steel yield strength must be 60,000

psi, unless otherwise noted on the shop drawings. The results of compression tests must be provided to the Department as results become available.

You must furnish the Engineer a Certificate of Compliance certifying the materials comply with the applicable specifications and a copy of all test results performed by the manufacturer necessary to assure contract compliance.

The manufacturer must submit for approval by the Engineer a water-reducing admixture for the purpose of increasing workability and reducing the water requirement for the concrete. The addition to the mix of calcium chloride or admixtures containing calcium chloride must not be allowed.

You must submit copies of all test results to the Engineer prior to delivery of the precast elements to the project site.

You must anticipate a five (5) day review time for all bridge plan submittals.

Submittal approval does not relieve you of the responsibility to perform the work in an acceptable manner and in accordance with the Plans, the Standard Specifications, and these Special Provisions. Department review is only for general conformance with the design concept of the project and general compliance with the information given in the Contract Documents. Any action is subject to the requirements of the Plans, Standard Specifications, and these Special Provisions. You are responsible for dimensions which must be confirmed and correlated at the project site; fabrication processes and techniques of construction; coordination of your work with that of all other trades; and the satisfactory performance of your work.

You must provide rock samples for Engineer's approval.

51-8.01D Quality Control and Assurance

Concrete compressive strength will be determined from compression tests made on cylinders or cores and will be tested in accordance to ASTM C 31, C 39, C 42 or C 497. The manufacturer furnishing precast elements must furnish all facilities and personnel necessary to carryout the tests required. For cylinder testing, a minimum of 3 cylinders must be taken for each lot of bridge elements. A lot will be defined as the precast elements made using the same concrete mix during a single day's production. For core testing, one core will be cut from each of 3 precast elements selected at random from each group of 15 or fewer elements made using a single concrete mix in the same day's production. Each lot will be considered separately for the purpose of testing and acceptance.

Cylinders must be made and tested as prescribed by the ASTM C 39 Specification. Cores must be obtained and tested for compressive strength in accordance with the provisions of the ASTM C 42 Specification.

Acceptability of Cylinder Tests - When the average compressive strength of all cylinders tested is equal to or greater than the design compressive strength, and not more than 10% of the cylinders tested have a compressive strength less than the design concrete strength, and no cylinder tested has a compressive strength less than 80% of the design compressive strength, then the lot will be accepted. When the compressive strength of the cylinders tested does not conform to these acceptance criteria, the acceptability of the lot may be determined as described in "Acceptability of Core Tests," below.

Acceptability of Core Tests - The compressive strength of the concrete in a lot is acceptable when the average core test strength is equal to or greater than the design concrete strength. When the compressive strength of the core tested is less than the design concrete strength, the precast element from which that core was taken may be re-cored. When the compressive strength of the re-core is equal to or greater than the design concrete strength, the compressive strength of the concrete in that lot is acceptable. When the compressive strength of any re-core is less than the design concrete strength, the precast element from which that core was taken will be rejected. Two precast elements from the remainder of the lot must be selected at random and one core must be taken from each. If the

compressive strength of both cores is equal to or greater than the design concrete strength, the compressive strength of the remainder of that lot is acceptable. If the compressive strength of either of the two cores tested is less than the design concrete strength, the remainder of the lot will be rejected or, at the option of the manufacturer, each precast element of the remainder of the lot must be cored and accepted individually, and any of these elements that have cores with less than the design concrete strength will be rejected.

The core holes must be plugged and sealed by the manufacturer in a manner such that the elements will meet all of the test requirements of this specification. Precast elements so sealed will be considered satisfactory for use.

51-8.02 MATERIALS

Concrete must comply with section 90 in addition to these specifications.

Reinforcement must comply with section 52 and the requirements of ASTM Designation A 615 Grade 60, in addition to these specifications.

The concrete for the precast elements must be air-entrained, composed of Portland cement, fine and coarse aggregates, admixtures, and water. Air-entrained concrete must contain 6 ± 2 percent air, and the air entraining admixture must conform to AASHTO M 154. Air content must be tested in accordance to ASTM C 231 or C 173.

The concrete facing units must be manufactured and tested in accordance with ASTM C 1372. Units must have a minimum 28 day compressive strength of 4,000 psi. The concrete must have a maximum moisture absorption of 5 percent. Units must be free of defects that indicate imperfect molding, concrete weakening or lessened durability. The units must be free of chips and cracks when viewed from a distance of 10 feet under diffused lighting. Dimensions variances must be in accordance with ASTM C 1372. Adjustments must be made for the specified patterns on the facing surface.

The units must be fully supported until the concrete reaches a minimum compressive strength of 1,000 psi. The units may be shipped after reaching a minimum compressive strength of 3,000 psi. All units must be handled, stored and shipped in such a manner as to eliminate the dangers of chipping, discoloration, cracks, fractures, and excessive bending stresses.

If any of the tests indicates noncompliance, you must perform a second testing of the same lot. The results of the second test will determine the acceptability of the lot. Units will be rejected because of failure to meet any of the requirements specified above. Minor cracks and chips incidental to the usual method of manufacture and shipments are not grounds for rejection.

All reinforcing and attachment devices for MSE system must be carefully inspected to insure they are true to size and free of defects that may impair their strength and durability. Reinforcing strips must be shop fabricated of cold drawn steel wire conforming to the minimum requirements of ASTM A 82 and must be welded into the finished fabric strips in accordance with ASTM A 185. Galvanization must be applied after the mesh is fabricated and conform to the minimum requirements of ASTM A 123 (AASHTO M-111). Connector pins must be 9/16 inch in diameter and be fabricated from A 82 steel. Galvanization must conform to ASTM A 123 (AASHTO M-111). Alignment pins must be 1/2 inch in diameter and fabricated from pultruded fiberglass. Alignment pins may also be fabricated from ASTM A 36 or A 82 steel and galvanized in conformance with ASTM A 123 (AASHTO M-111) when specified.

The unit drainage fill material in and for a nominal distance of 1 foot directly behind the concrete facing units or as indicated on the construction drawings must consist of a crushed stone material complying to the following gradation:

Sieve Size	Percent Passing
1 inch	100
3/4 inch	75-100
No. 4	0-10
No. 50	0-5

In addition the unit drainage fill must comply with the electrochemical properties below.

Structure backfill for earth retaining structures with soil reinforcement must be free of organic material and substantially free of shale or other soft materials of poor durability. Structure backfill must not contain slag aggregate or recycled materials such as glass, shredded tires, portland cement concrete rubble, asphaltic concrete material, or other unsuitable material. Structure backfill must conform to the following requirements:

Gradation Requirements		
Sieve Size	Percent Passing	California Test
6 inch	100	202
3 inch	78-100	202
No. 4	---	202
No. 30	0-60	202
No. 200	0-15	202

Property Requirements		
Test	Requirement	California Test
Sand Equivalent	12 min	217
Plasticity Index	6 max	204
Minimum Resistivity	2000 ohm-cm	643
Chlorides	< 250 ppm	422
Sulfates	< 500 ppm	417
pH	5.5 to 10.0	643

If 12 percent or less passes the No. 200 sieve and 50 percent or less passes the No. 4, the Sand Equivalent and Plasticity Index requirements will not apply

Drainage pipe must be perforated or slotted PVC pipe manufactured in accordance with ASTM D 3034 or corrugated HDPE pipe manufactured in accordance with AASHTO M 252, unless otherwise specified.

Geotextile filter fabric must be a 4.0 oz/sy, polypropylene, needlepunched nonwoven fabric, unless otherwise specified.

Concrete leveling pads for the MSE system must comply with section 90-2.

Portland Cement must conform to the requirements of ASTM Specifications C 150-Type II cement. Coarse Aggregate must consist of stone having a maximum size of 1 inch. Aggregate must meet requirements for ASTM C 33.

The aggregates, cement, and water must be proportioned and mixed in a batch mixer to produce a homogeneous concrete meeting the strength requirements of this specification. The proportion of Portland cement in the mixture must not be less than 564 pounds (6 sacks) per cubic yard of concrete.

Rock must have the values for the material properties shown in the following table:

Rock Material Properties

Property	California Test	Value
Apparent Specific Gravity	206	2.5 min
Absorption	206	4.2% max*
Durability Index	229	52 min*

$$\text{Coarse Durability Index} \\ \% \text{ Absorption} + 1 = \text{Durability Absorption Ratio (DAR)}$$

*Based on the formula contained herein, absorption may exceed 4.2% if DAR is greater than 10. Durability Index may be less than 52 if DAR is greater than 24.

No. 1 Rock Backing must comply with the rock grading shown in the following table:

Rock Size	Percent Smaller Than
16"	100
12"	75-100
8"	0-20
6"	0

300lb Rock (D50=18") must comply with the rock grading shown in the following table:

Rock Size	Percent Smaller Than
27"	100
18"	50
9"	0

1/4 Ton Rock (D50=21") must comply with the rock grading shown in the following table:

Rock Size	Percent Smaller Than
32"	100
21"	50
10"	0

Percentage is based on the number of rocks per size range versus the total number of rocks in any 100 square foot area. Rock size must be measured along the smallest dimension of each rock.

Where 18 inch thickness of rock layering is designated on the Plans, it must be interpreted as a nominal thickness. This means that some areas may be 16 inches thick, some may be 18 inches and some may be greater than 18 inches thick. In any case, in any 100 square foot area of rock, the average thickness of the rock layering must be greater than or equal to 18 inches.

Rock must be angular with not fewer than three fractured surfaces and of such shape as to form a stable protective structure after placement. Do not use rounded cobbles.

Rolled Erosion Control Product (Blanket) Type B must comply with section 21-1.02O(4).

Sealant Adhesive must be waterproof and comply with section 95-2.03.

51-8.03 CONSTRUCTION

Earthwork must comply with section 19.

Refer to section 8.5.4 of the Geotechnical Design Report, Blackburn Consulting, Inc., October 1012. Expect to encounter hard rock in the bottom of the excavation where bridge footings are to be placed. You must immediately notify Engineer so that an assessment of the impact on the design can be made. If the design can not be modified and the removal of the rock is necessary, the cost associated with the rock removal and disposal must be included with the unit price bid for "Precast Bridge System".

Structure backfill within 1 foot of the concrete surfaces of the precast concrete bridge units must be hand compacted. Vibrating roller compactors must not be started or stopped within the critical backfill zone limits (Zone B) as shown on Sheet DD-15 of the Plans. Construction or compaction equipment weighing less than 10 tons must not be operated within the critical backfill zone limits or over the bridge units until the crown of the bridge is covered with a minimum of 4 inches of compacted fill. After a minimum of 1 foot of compacted fill is placed over the crown of the bridge, construction equipment weighing less than 30 tons may cross the bridge. Equipment weighing 30 tons or greater may cross the bridge after a minimum of 2 feet of compacted fill is placed over the crown of the bridge units or the roadway structural section is in place. In no case must equipment operating in excess of the design load (HS20) be allowed over the bridge units. As a precaution against introducing unbalanced stresses in the bridge, when placing backfill, at no time must the difference between the heights of fill on opposite sides of the bridge exceed 24 inches. Backfill in front of wingwalls must be to the daylight lines shown in the plans. During the backfilling operation, care must be taken to keep all joint wrap and filter fabric in its proper location over the joint.

Precast reinforced concrete bridge units manufactured under the plans and these specifications must be designated by span and rise. Keystone wingwalls and headwalls manufactured under the plans and these specifications must be designated by length, height, and deflection angle.

The quality of materials, the process of manufacture, and the finished precast elements must be subject to inspection by the Department. Precast elements may be repaired, if necessary, because of imperfections in manufacture or handling damage.

The precast elements will be subject to rejection due to any deviation from the specification requirements. Individual precast elements may be rejected because of any of the following:

1. Fractures or cracks passing through the wall, except for a single end crack that does not exceed one half the thickness of the wall.
2. Defects that indicate proportioning, mixing, and molding not in compliance.
3. Honeycombed or open texture.
4. Damaged ends, where such damage would prevent making a satisfactory joint.

Each bridge unit must be clearly marked by waterproof paint. The following must be shown on the inside of the vertical leg of the bridge section:

Bridge Span x Bridge Rise
Date of Manufacture
Name or trademark of the manufacturer

The precast bridge units must be installed on cast-in-place concrete footings. The footings must be monolithic. Expansion joints must not be used. The completed footing surface must be constructed in accordance with grades shown on the plans. When tested with a ten (10) foot straight edge, the surface must not vary more than 1/4 inch in ten (10) feet. A three (3) inch deep keyway must be formed in the top surface of the bridge footing 3 inches clear of the inside and outside faces of the bridge units, unless specified otherwise on the plans. The footings must be given a smooth float finish and must reach a compressive strength of 2,000 psi before placement of the precast bridge.

The precast concrete elements must be cured for a sufficient length of time so that the concrete will develop the specified compressive strength in 28 days or less. For the precast elements of the bridge system, any one of the following methods of curing or combinations thereof must be used:

1. Steam Curing - The precast elements may be low pressure, steam cured by a system that will maintain a moist atmosphere.
2. Water Curing - The precast elements may be water cured by any method that will keep the sections moist.

3. Membrane Curing - A sealing membrane conforming to the requirements of ASTM Specification C 309 may be applied and must be left intact until the required concrete compressive strength is attained. The concrete temperature at the time of application must be within ± 10 degrees F of the atmospheric temperature. All surfaces must be kept moist prior to the application of the compounds and must be damp when the compound is applied.

Forms used in manufacture must be sufficiently rigid and accurate to maintain the bridge unit dimensions within the following permissible variations:

Bridge Units

1. Internal Dimensions - The internal dimension must vary not more than 1 percent from the design dimensions nor more than 1-1/2 inches whichever is less.
2. Slab and Wall Thickness - The slab and wall thickness must not be less than that shown in the design by more than 1/4 inch. A thickness more than that required in the design will not be cause for rejection.
3. Length of Opposite Surfaces - Variations in laying lengths of two opposite surfaces of the bridge unit must not be more than 1/2 inch in any section, except where beveled ends for laying of curves are specified by the purchaser.
4. Length of Section - The underrun in length of a section must not be more than 1/2 inch in any bridge unit.
5. Position of Reinforcement - The maximum variation in position of the reinforcement must be +1/2 inch. In no case will the cover over the reinforcement be less than 1-1/2 inches for the outside circumferential steel or be less than 1 inch for the inside circumferential steel as measured to the external or internal surface of the bridge. These tolerances or cover requirements do not apply to mating surfaces of the joints.
6. Area of Reinforcement - The areas of steel reinforcement must be the design steel areas as shown in the manufacturer's shop drawings. Steel areas greater than those required will not be cause for rejection. The permissible variation in diameter of any reinforcement must conform to the tolerances prescribed in the ASTM Specification for that type of reinforcement.

The permissible variation in diameter of any reinforcing must conform to the tolerances prescribed in the ASTM Specification for that type of reinforcing. Steel area greater than that required will not be cause for rejection.

All casting surfaces must be of a smooth nonporous material.

Handling devices will be permitted in each precast element for the purpose of handling and installation. The precast elements must be stored in such a manner to prevent cracking or damage. The units must not be moved until the concrete compressive strength has reached a minimum of 2500 psi and they must not be stored in an upright position.

All reinforcing steel and hardware for the precast elements must be fabricated and placed in accordance with the detailed shop drawings submitted. Reinforcement must consist of welded wire fabric conforming to ASTM A 185 or ASTM A 497, or deformed billet steel bars conforming to ASTM A 615 Grade 60. Longitudinal distribution reinforcement may consist of welded wire fabric or deformed billet-steel bars.

Placement of Reinforcement in Precast Bridge Units

The cover of concrete over the outside circumferential reinforcement must be 2 inches minimum. The cover of concrete over the inside circumferential reinforcement must be 1-1/2 inches minimum, unless otherwise noted on the shop drawings. The clear distance of the end circumferential wires must not be less than one inch nor more than two inches from the ends of each section. Reinforcement must be

assembled utilizing single or multiple layers of welded wire fabric, not to exceed 3 layers, supplemented with a single layer of deformed billet-steel bars, when necessary. Welded wire fabric must be composed of circumferential and longitudinal wires meeting the spacing requirements of this Section and must contain sufficient longitudinal wires extending through the bridge unit to maintain the shape and position of the reinforcement. Longitudinal distribution reinforcement may be welded wire fabric or deformed billet-steel bars and must meet the spacing requirements of this Section. The ends of the longitudinal distribution reinforcement must be not more than 3 inches and not less than 1-1/2 inches from the ends of the bridge unit. The outside and inside circumferential reinforcing steel for the corners of the bridge must be bent to such an angle that is approximately equal to the configuration of the bridge's outside corner.

Laps, Welds, and Spacing for Precast Bridge Unit

Tension splices in the circumferential reinforcement must be made by lapping. Laps may be tack welded together for assembly purposes. For smooth welded wire fabric, the overlap must meet the requirements of AASHTO 8.30.2 and 8.32.6. For deformed welded wire fabric, the overlap must meet the requirements of AASHTO 8.30.1 and 8.32.5. The overlap of welded wire fabric must be measured between the outer most longitudinal wires of each fabric sheet. For deformed billet-steel bars, the overlap must meet the requirements of AASHTO 8.25. For splices other than tension splices, the overlap must be a minimum of 12 inches for welded wire fabric or deformed billet-steel bars. The spacing center to center of the circumferential wires in a wire fabric sheet must be not less than 2 inches nor more than 4 inches. The spacing center to center of the longitudinal wires must not be more than 8 inches. The spacing center to center of the longitudinal distribution steel for either line of reinforcing in the top slab must be not more than 16 inches.

The bridge units must be produced with flat butt ends. The ends of the bridge units must be such that when the sections are laid together they will make a continuous line of with a smooth interior free of appreciable irregularities, all compatible with the permissible variations noted above. The joint width between adjacent precast units must not exceed 3/4 inches.

The bridge units must be substantially free of fractures. The ends of the bridge units must be normal to the walls and centerline of the bridge section, within the limits of the variations given above except where beveled ends are specified. The surface of the precast elements must be a smooth steel form or troweled surface. Trapped air pockets causing surface defects must be considered as part of a smooth, steel form finish.

The bridge units must be installed on cast-in-place concrete footings.

The bridge units, wingwalls, and headwalls must be placed as shown on the Plans. Special care must be taken in setting the elements to the true lines and grades. The bridge units must be set on 6 by 6 inches minimum masonite or steel shims. A minimum of 1/2 inch gap must be provided between the footing and the bottom of the bridge's vertical legs. The gap must be filled with grout.

The butt joint made by two adjoining bridge units must be covered with a 7/8 by 1-3/8 inches preformed bituminous joint sealant and a minimum of a 9 inch wide joint wrap. The surface must be free of dirt before applying the joint material. A primer compatible with the joint wrap to be used must be applied for a minimum width of 9 inches on each side of the joint. The external wrap must be EZ-WRAP RUBBER by Press-Seal Gasket Corporation, Seal Wrap by Mar Mac Manufacturing Co. Inc., or approved equal. The joint must be covered continuously from the bottom of one bridge section leg, across the top of the arch and to the opposite bridge section leg. Any laps that result in the joint wrap must be a minimum of 6 inches long with the overlap running downhill.

Unless otherwise indicated on the plans or elsewhere in the specifications, the concrete surface for the front face of the concrete facing units must have a tri-planer split rock face finish. Concrete facing units must be placed so that their final position is vertical or battered.

The foundation for the MSE system must be graded level for a width equal to the overall length of reinforcement elements plus 1.0 foot or as shown on the plans. Before wall construction, except where

constructed on rock, the foundation must be compacted with a smooth wheel vibratory roller. Any foundation soils found to be unsuitable will be removed and replaced with structure backfill per section 19-3.

Concrete for leveling pads must be placed at least 24 hours before erecting face units. Concrete leveling pads must be cured a minimum of 12 hours before placement of wall units.

The first course of concrete wall units must be placed on the leveling pad and checked for elevation and alignment. They must also be checked for full contact with the leveling pad. Install the connecting pins at the reinforcement locations and the alignment pins at all other locations. Fill all voids with unit drainage fill and tamp. Place the unit drainage fill and structural backfill material behind this course and compact. Be sure that each course is completely filled, backfilled and compacted before placing the reinforcement or proceeding to the next course. Clean all excess material from the top of units and install the next course. Ensure that connecting and alignment pins protrude into the adjoining courses. Move each unit forward, toward the exposed wall face, until it is restrained by the pins in the previous course. Repeat this procedure to the extent of the wall height.

As structure backfill material is placed behind the wall units, the units must be maintained in position by means of the alignment pin. Wall facing vertical tolerances and horizontal alignment must not exceed 3/4 inch when measured with a 10 foot straight edge. During construction, the maximum allowable offset in any unit joint will be 3/4 inch. The overall vertical tolerance of the wall from top to bottom must not exceed 3/4 inch in 10 feet of wall height.

Reinforcement elements of the proper wire size and length must be placed at the locations shown. The reinforcement must be connected to the wall units by placing the connectors over the steel pins and placing the reinforcement normal to the face of the wall unless otherwise shown. Before placing reinforcing elements, structure backfill must be compacted in accordance with these specifications. All soil reinforcements must be tensioned to remove any slack in the connection.

Where cap units are the finished top of wall, apply seal to the top surface of the adjoining lower units just before placing the cap unit. Insure that all contact surfaces are dry and free from debris before applying adhesive.

Constant monitoring of the wall alignment during construction determines the adequacy of the construction techniques and the need for addition alignment procedures.

Unit drainage and structure fill placement must closely follow erection of each course of units. The Engineer may accept the placement of the units from one reinforcement layer to the next before placement of the fill. In this case, you must demonstrate to the Engineer's satisfaction the ability of the unit drainage fill to fill the voids using this procedure. Structure backfill must be placed in such a manner as to avoid any damage or disturbance of the wall materials or misalignment of the facing units or reinforcing elements. At each reinforcement level, the structure backfill must be placed 0.1 foot higher than level of the connection before installing the soil reinforcement.

Structure backfill must be compacted to 95 percent of the maximum density as determined by AASHTO T-99 or 92 percent of AASHTO T-180 maximum density. Follow Method C or D of the corresponding test with oversized corrections as outlined in Note 7. For structure backfill containing more than 30 percent retained on the 3/4-inch sieve, a method of compaction consisting of at least 4 passes by a heavy roller must be used.

The moisture content of the structure backfill material before and during compaction must be uniformly distributed throughout each layer. Structure backfill material must have a placement moisture content no less than 3 percent below or equal to the optimum content. Structure backfill with a placement moisture content in excess of the optimum moisture content must be removed and reworked until the moisture content is uniformly acceptable throughout the entire lift.

The maximum lift thickness after compaction must not exceed 8 inches. You must decrease the lift thickness, if necessary, to obtain the specified density. Compaction within 3 feet of the back face of the wall must be achieved by at least three passes of a lightweight mechanical tamper, roller or vibratory system.

At the end of each day's operation, you must slope the last level of backfill away from the wall facing to rapidly direct runoff away from the wall face. In addition, you must not allow surface runoff from adjacent areas to enter the wall construction site.

The toe rocks along the Keystone Block Wall (MSE) must be 300 lbs. to 1/4 Ton.

On each rock, three perpendicular axes can be identified in three dimensions: a short axis, an intermediate axis, and a long axis. Rock must be placed with the short axis in a vertical plane parallel to the face of the slope, the intermediate axis perpendicular to the face of the slope, and the long axis horizontal and parallel to the face of the slope. Each rock must have a minimum of three points bearing on the rocks below and adjacent.

Rocks must be placed so as to provide a minimum of voids. The larger rocks must be placed in the toe course. The rock must be placed in accordance with the lines and grades as shown to form the specified cross section in a roughly regular surface without large cavities or excess projections above the general lines of the rock layer.

51-8.04 PAYMENT

Partial payments will be made based on the percentage of work completed.

STATE OF CALIFORNIA - DEPARTMENT OF TRANSPORTATION
ENCROACHMENT PERMIT

TR-0120 (REV 6/2012)

Permit No. 0313-NMC0522	
Dist/Co/Rte/PM 03-ED-50-1.07/R2.4	
Date July 11, 2013	
Fee Paid \$ Exempt	Deposit \$ N/A
Performance Bond Amount (1) \$ N/A	Payment Bond Amount (2) \$ N/A
Bond Company	
Bond Number (1)	Bond Number (2)

In compliance with (Check one):

- Your application of July 11, 2013
- Utility Notice No. _____ of _____
- Agreement No. _____ of _____
- RAW Contract No. _____ of _____

TO:
 El Dorado County, DOT
 2850 Fairlane Court
 Placerville, CA 95667
 Attn: Matthew Smeltzer
 (530) 621-5912
 _____, PERMITTEE

and subject to the following, PERMISSION IS HEREBY GRANTED to:
 Construct Highway 50/Silva Valley Parkway interchange including four (4) new bridges:
 1. Silva Valley Parkway O.C.(Br#25-.0127), 2. WB off-ramp/Carson Creek(Br#25-0130K), 3. WB on-ramp/Calrksville U.C.(BR #25-0129K), 4. EB off-ramp/Clarksville U.C.(Br #25-0128S), Carson Creek MSE/retaining wall(#25E0007), Bucks Ravine RCB extension, Carson Creek Culvert. Installation of traffic signals, lighting & signs, water & sewer pipes, storm drain pipes, grading, paving and relocation of existing Tong Road in the city limits of El Dorado Hills per attached plans.

ALL WORK SHALL BE DONE IN ACCORDANCE WITH THE CURRENT (2010) DEPARTMENT OF TRANSPORTATION STANDARD SPECIFICATIONS, MUTCD, CPUC, AND THE DEPARTMENT OF TRANSPORTATION ENCROACHMENT PERMIT UTILITY PROVISIONS.

-----continued on page 2-----

THIS PERMIT IS NOT A PROPERTY RIGHT AND DOES NOT TRANSFER WITH THE PROPERTY TO A NEW OWNER.

The following attachments are also included as part of this permit (Check applicable):		In addition to fee, the permittee will be billed actual costs for: <input type="checkbox"/> Yes <input checked="" type="checkbox"/> No Review <input type="checkbox"/> Yes <input checked="" type="checkbox"/> No Inspection <input checked="" type="checkbox"/> Yes Field work <i>(If any Caltrans effort expended)</i>
<input checked="" type="checkbox"/> Yes <input type="checkbox"/> No General Provisions <input type="checkbox"/> Yes <input checked="" type="checkbox"/> No Utility Maintenance Provisions <input checked="" type="checkbox"/> Yes <input type="checkbox"/> No Special Provisions TRAFFIC CONTROL <input type="checkbox"/> Yes <input checked="" type="checkbox"/> No A Cal-OSHA permit, if required: Permit No. _____ <input type="checkbox"/> Yes <input checked="" type="checkbox"/> No As-Built Plans Submittal Route Slip for Locally Advertised Projects <input type="checkbox"/> Yes <input checked="" type="checkbox"/> No Storm Water Pollution Protection Plan		

Yes No The information in the environmental documentation has been reviewed and considered prior to approval of this permit.

This permit is void unless the work is completed before October 1, 2016
 This permit is to be strictly construed and no other work other than specifically mentioned is hereby authorized.
 No project work shall be commenced until all other necessary permits and environmental clearances have been obtained

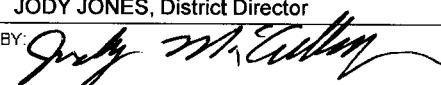
Veera Nanugonda, Construction RE Cell # 530-218-4803; Office # 530-621-0986. 3065 Blairs Lane Placerville CA 95667 cc: Rusty Grout, Sunrise Maint. Region Clark Peri, Project Manager, T Tara McCann, Permit Inspector	APPROVED: JODY JONES, District Director BY:  FOR TIM GREUTERT, Chief-Encroachment Permits Branch
---	---

ADA Notice For individuals with sensory disabilities, this document is available in alternate formats. For information call (916) 654-6410 or TDD (916) 654-3880 or write Records and Forms Management, 1120 N Street, MS-89, Sacramento, CA 95814.

PERMISSIONS Conditions Continued:

Notwithstanding General Provision #4, your contractor shall obtain a Permit (Double Permit) to perform the work authorized. There is no fee for the Contractor's Permit. Contractor shall provide a copy of their bond before being issued the Double Permit.

Permittee shall contact Resident Engineer Veera Nanugonda, Cell # 530-218-4803, SEVEN (7) working days prior to commencing work, to arrange a pre-job meeting. A 24-hour notification before restarting work shall be strictly adhered to. All work shall be conducted and completed to the satisfaction of Caltrans representative. Immediately following completion of the work permitted herein, the Permittee shall fill out and mail the Notice of Completion attached to this Permit.

STATE OF CALIFORNIA, DEPARTMENT OF TRANSPORTATION
ENCROACHMENT PERMIT GENERAL PROVISIONS
TR-0045 (REV. 05/2007)

1. **AUTHORITY:** The Department's authority to issue encroachment permits is provided under, Div. 1, Chpt. 3, Art. 1, Sect. 660 to 734 of the Streets and Highways Code.
2. **REVOCATION:** Encroachment permits are revocable on five days notice unless otherwise stated on the permit and except as provided by law for public corporations, franchise holders, and utilities. These General Provisions and the Encroachment Permit Utility Provisions are subject to modification or abrogation at any time. Permittees' joint use agreements, franchise rights, reserved rights or any other agreements for operating purposes in State highway right of way are exceptions to this revocation.
3. **DENIAL FOR NONPAYMENT OF FEES:** Failure to pay permit fees when due can result in rejection of future applications and denial of permits.
4. **ASSIGNMENT:** No party other than the permittee or permittee's authorized agent is allowed to work under this permit.
5. **ACCEPTANCE OF PROVISIONS:** Permittee understands and agrees to accept these General Provisions and all attachments to this permit, for any work to be performed under this permit.
6. **BEGINNING OF WORK:** When traffic is not impacted (see Number 35), the permittee shall notify the Department's representative, two (2) days before the intent to start permitted work. Permittee shall notify the Department's Representative if the work is to be interrupted for a period of five (5) days or more, unless otherwise agreed upon. All work shall be performed on weekdays during regular work hours, excluding holidays, unless otherwise specified in this permit.
7. **STANDARDS OF CONSTRUCTION:** All work performed within highway right of way shall conform to recognized construction standards and current Department Standard Specifications, Department Standard Plans High and Low Risk Facility Specifications, and Utility Special Provisions. Where reference is made to "Contractor and Engineer," these are amended to be read as "Permittee and Department representative."
8. **PLAN CHANGES:** Changes to plans, specifications, and permit provisions are not allowed without prior approval from the State representative.
9. **INSPECTION AND APPROVAL:** All work is subject to monitoring and inspection. Upon completion of work, permittee shall request a final inspection for acceptance and approval by the Department. The local agency permittee shall not give final construction approval to its contractor until final acceptance and approval by the Department is obtained.
10. **PERMIT AT WORKSITE:** Permittee shall keep the permit package or a copy thereof, at the work site and show it upon request to any Department representative or law enforcement officer. If the permit package is not kept and made available at the work site, the work shall be suspended.
11. **CONFLICTING ENCROACHMENTS:** Permittee shall yield start of work to ongoing, prior authorized, work adjacent to or within the limits of the project site. When existing encroachments conflict with new work, the permittee shall bear all cost for rearrangements, (e.g., relocation, alteration, removal, etc.).
12. **PERMITS FROM OTHER AGENCIES:** This permit is invalidated if the permittee has not obtained all permits necessary and required by law, from the Public Utilities Commission of the State of California (PUC), California Occupational Safety and Health Administration (Cal-OSHA), or any other public agency having jurisdiction.
13. **PEDESTRIAN AND BICYCLIST SAFETY:** A safe minimum passageway of 4' shall be maintained through the work area at existing pedestrian or bicycle facilities. At no time shall pedestrians be diverted onto a portion of the street used for vehicular traffic. At locations where safe alternate passageways cannot be provided, appropriate signs and barricades shall be installed at the limits of construction and in advance of the limits of construction at the nearest crosswalk or intersection to detour pedestrians to facilities across the street. Attention is directed to Section 7-1.09 Public Safety of the Department Standard Specifications.
14. **PUBLIC TRAFFIC CONTROL:** As required by law, the permittee shall provide traffic control protection warning signs, lights, safety devices, etc., and take all other measures necessary for traveling public's safety. While providing traffic control, the needs and control of all road users [motorists, bicyclists and pedestrians, including persons with disabilities in accordance with the Americans with Disabilities Act of 1990 (ADA)] shall be an essential part of the work activity.

Day and night time lane closures shall comply with the California Manual on Uniform Traffic Control Devices (Part 6, Temporary Traffic Control), Standard Plans, and Standard Specifications for traffic control systems. These General Provisions are not intended to impose upon the permittee, by third parties, any duty or standard of care, greater than or different from, as required by law.
15. **MINIMUM INTERFERENCE WITH TRAFFIC:** Permittee shall plan and conduct work so as to create the least possible inconvenience to the traveling public; traffic shall not be unreasonably delayed. On conventional highways, permittee shall place properly attired flagger(s) to stop or warn the traveling public in compliance with the California Manual on Uniform Traffic Control Devices (Chapter 6E, Flagger Control).
16. **STORAGE OF EQUIPMENT AND MATERIALS:** The storage of equipment or materials is not allowed within State highway right-of-way, unless specified within the Special Provisions of this specific encroachment permit. If Encroachment Permit Special Provisions allow for the storage of equipment or materials within the State right of way, the equipment and material storage shall comply with Standard Specifications, Standard Plans, Special Provisions, and the Highway Design Manual. The clear recovery zone widths must be followed and are the minimum desirable for the type of facility indicated below: freeways and expressways - 30', conventional highways (no curbs) - 20', conventional highways (with curbs) - 1.5'. If a fixed object cannot be eliminated, moved outside the clear recovery zone, or modified to be made yielding, it should be shielded by a guardrail or a crash cushion.
17. **CARE OF DRAINAGE:** Permittee shall provide alternate drainage for any work interfering with an existing drainage facility in compliance with the Standard Specifications, Standard Plans and/or as directed by the Department's representative.
18. **RESTORATION AND REPAIRS IN RIGHT OF WAY:** Permittee is responsible for restoration and repair of State highway right of way resulting from permitted work (State Streets and Highways Code, Sections 670 et. seq.).

19. **RIGHT OF WAY CLEAN UP:** Upon completion of work, permittee shall remove and dispose of all scraps, brush, timber, materials, etc. off the right of way. The aesthetics of the highway shall be as it was before work started.
20. **COST OF WORK:** Unless stated in the permit, or a separate written agreement, the permittee shall bear all costs incurred for work within the State right of way and waives all claims for indemnification or contribution from the State.
21. **ACTUAL COST BILLING:** When specified in the permit, the Department will bill the permittee actual costs at the currently set hourly rate for encroachment permits.
22. **AS-BUILT PLANS:** When required, permittee shall submit one (1) set of folded as-built plans within thirty (30) days after completion and approval of work in compliance with requirements listed as follows:
1. Upon completion of the work provided herein, the permittee shall send one vellum or paper set of As-Built plans, to the State representative. Mylar or paper sepia plans are not acceptable.
 2. All changes in the work will be shown on the plans, as issued with the permit, including changes approved by Encroachment Permit Rider.
 3. The plans are to be stamped or otherwise noted AS-BUILT by the permittee's representative who was responsible for overseeing the work. Any original plan that was approved with a State stamp, or Caltrans representative signature, shall be used for producing the As-Built plans.
 4. If As-Built plans include signing or striping, the dates of signing or striping removal, relocation, or installation shall be shown on the plans when required as a condition of the permit. When the construction plans show signing and striping for staged construction on separate sheets, the sheet for each stage shall show the removal, relocation or installation dates of the appropriate staged striping and signing.
 5. As-Built plans shall contain the Permit Number, County, Route, and Post Mile on each sheet.
 6. Disclaimer statement of any kind that differ from the obligations and protections provided by Sections 6735 through 6735.6 of the California Business and Professions Code, shall not be included on the As-Built plans. Such statements constitute non-compliance with Encroachment Permit requirements, and may result in the Department of Transportation retaining Performance Bonds or deposits until proper plans are submitted. Failure to comply may also result in denial of future permits, or a provision requiring a public agency to supply additional bonding.
23. **PERMITS FOR RECORD PURPOSES ONLY:** When work in the right of way is within an area under a Joint Use Agreement (JUA) or a Consent to Common Use Agreement (CCUA), a fee exempt permit is issued to the permittee for the purpose of providing a notice and record of work. The Permittee's prior rights shall be preserved without the intention of creating new or different rights or obligations. "Notice and Record Purposes Only" shall be stamped across the face of the permit.
24. **BONDING:** The permittee shall file bond(s), in advance, in the amount set by the Department. Failure to maintain bond(s) in full force and effect will result in the Department stopping of all work and revoking permit(s). Bonds are not required of public corporations or privately owned utilities, unless permittee failed to comply with the provision and conditions under a prior permit. The surety company is responsible for any latent defects as provided in California Code of Civil Procedures, Section 337.15. Local agency permittee shall comply with requirements established as follows: In recognition that project construction work done on State property will not be directly funded and paid by State, for the purpose of protecting stop notice claimants and the interests of State relative to successful project completion, the local agency permittee agrees to require the construction contractor furnish both a payment and performance bond in the local agency's name with both bonds complying with the requirements set forth in Section 3-1.02 of State's current Standard Specifications before performing any project construction work. The local agency permittee shall defend, indemnify, and hold harmless the State, its officers and employees from all project construction related claims by contractors and all stop notice or mechanic's lien claimants. The local agency also agrees to remedy, in a timely manner and to State's satisfaction, any latent defects occurring as a result of the project construction work.
25. **FUTURE MOVING OF INSTALLATIONS:** Permittee understands and agrees to relocate a permitted installation upon notice by the Department. Unless under prior property right or agreement, the permittee shall comply with said notice at his sole expense.
26. **ARCHAEOLOGICAL/HISTORICAL:** If any archaeological or historical resources are revealed in the work vicinity, the permittee shall immediately stop work, notify the Department's representative, retain a qualified archaeologist who shall evaluate the site, and make recommendations to the Department representative regarding the continuance of work.
27. **PREVAILING WAGES:** Work performed by or under a permit may require permittee's contractors and subcontractors to pay appropriate prevailing wages as set by the Department of Industrial Relations. Inquiries or requests for interpretations relative to enforcement of prevailing wage requirements are directed to State of California Department of Industrial Relations, 525 Golden Gate Avenue, San Francisco, California 94102.
28. **RESPONSIBILITY FOR DAMAGE:** The State of California and all officers and employees thereof, including but not limited to the Director of Transportation and the Deputy Director, shall not be answerable or accountable in any manner for injury to or death of any person, including but not limited to the permittee, persons employed by the permittee, persons acting in behalf of the permittee, or for damage to property from any cause. The permittee shall be responsible for any liability imposed by law and for injuries to or death of any person, including but not limited to the permittee, persons employed by the permittee, persons acting in behalf of the permittee, or for damage to property arising out of work, or other activity permitted and done by the permittee under a permit, or arising out of the failure on the permittee's part to perform his obligations under any permit in respect to maintenance or any other obligations, or resulting from defects or obstructions, or from any cause whatsoever during the progress of the work, or other activity or at any subsequent time, work or other activity is being performed under the obligations provided by and contemplated by the permit.
- The permittee shall indemnify and save harmless the State of California, all officers, employees, and State's contractors, thereof, including but not limited to the Director of Transportation and the Deputy Director, from all claims, suits or actions of every name, kind and description brought for or on account of injuries to or death of any person, including but not limited to the permittee, persons employed by the permittee, persons acting in behalf of the permittee and the public, or damage to property resulting from the performance of work or other activity under the permit, or arising out of the failure on the permittee's part to perform his obligations under any permit in respect to maintenance or any other obligations, or resulting from defects or obstructions, or from any cause whatsoever during the progress of the work, or other activity or at any subsequent time, work or other activity is being performed under the obligations provided by and contemplated by the permit, except as otherwise provided by statute.

The duty of the permittee to indemnify and save harmless includes the duties to defend as set forth in Section 2778 of the Civil Code. The permittee waives any and all rights to any type of expressed or implied indemnity against the State, its officers, employees, and State contractors. It is the intent of the parties that the permittee will indemnify and hold harmless the State, its officers, employees, and State's contractors, from any and all claims, suits or actions as set forth above regardless of the existence or degree of fault or negligence, whether active or passive, primary or secondary, on the part of the State, the permittee, persons employed by the permittee, or acting on behalf of the permittee.

For the purpose of this section, "State's contractors" shall include contractors and their subcontractors under contract to the State of California performing work within the limits of this permit.

29. NO PRECEDENT ESTABLISHED: This permit is issued with the understanding that it does not establish a precedent.

30. FEDERAL CIVIL RIGHTS REQUIREMENTS FOR PUBLIC ACCOMMODATION:

A. The permittee, for himself, his personal representative, successors in interest, and assigns as part of the consideration hereof, does hereby covenant and agree that:

1. No person on the grounds of race, color, or national origin shall be excluded from participation in, be denied the benefits of, or be otherwise subjected to discrimination in the use of said facilities.

2. That in connection with the construction of any improvements on said lands and the furnishings of services thereon, no discrimination shall be practiced in the selection and retention of first-tier subcontractors in the selection of second-tier subcontractors.

3. That such discrimination shall not be practiced against the public in their access to and use of the facilities and services provided for public accommodations (such as eating, sleeping, rest, recreation), and operation on, over, or under the space of the right of way.

4. That the permittee shall use the premises in compliance with all other requirements imposed pursuant to Title 15, Code of Federal Regulations, Commerce and Foreign Trade, Subtitle A. Office of the Secretary of Commerce, Part 8 (15 C.F.R. Part 8) and as said Regulations may be amended.

5. That in the event of breach of any of the above nondiscrimination covenants, the State shall have the right to terminate the permit and to re-enter and repossess said land and the land and the facilities thereon, and hold the same as if said permit had never been made or issued.

31. MAINTENANCE OF HIGHWAYS: The permittee agrees, by acceptance of a permit, to properly maintain any encroachment. This assurance requires the permittee to provide inspection and repair any damage, at permittee's expense, to State facilities resulting from the encroachment.

32. SPECIAL EVENTS: In accordance with subdivision (a) of Streets and Highways Code Section 682.5, the Department of Transportation shall not be responsible for the conduct or operation of the permitted activity, and the applicant agrees to defend, indemnify, and hold harmless the State and the city or county against any and all claims arising out of any activity for which the permit is issued.

The permittee understands and agrees to comply with the obligations of Titles II and III of the Americans with Disabilities Act of 1990 in the conduct of the event, and further agrees to indemnify and save harmless the State of California, all officers and employees thereof, including but not limited to the Director of Transportation, from any claims or liability arising out of or by virtue of said Act.

33. PRIVATE USE OF RIGHT OF WAY: Highway right of way shall not be used for private purposes without compensation to the State.

The gifting of public property use and therefore public funds is prohibited under the California Constitution, Article 16.

34. FIELD WORK REIMBURSEMENT: Permittee shall reimburse State for field work performed on permittee's behalf to correct or remedy hazards or damaged facilities, or clear debris not attended to by the permittee.

35. NOTIFICATION OF DEPARTMENT AND TMC: The permittee shall notify the Department's representative and the Transportation Management Center (TMC) at least 7 days before initiating a lane closure or conducting an activity that may cause a traffic impact. A confirmation notification should occur 3 days before closure or other potential traffic impacts. In emergency situations when the corrective work or the emergency itself may affect traffic, TMC and the Department's representative shall be notified as soon as possible.

36. SUSPENSION OF TRAFFIC CONTROL OPERATION: The permittee, upon notification by the Department's representative, shall immediately suspend all lane closure operations and any operation that impedes the flow of traffic. All costs associated with this suspension shall be borne by the permittee.

37. UNDERGROUND SERVICE ALERT (USA) NOTIFICATION: Any excavation requires compliance with the provisions of Government Code Section 4216 et. seq., including, but not limited to notice to a regional notification center, such as Underground Service Alert (USA). The permittee shall provide notification at least 48 hours before performing any excavation work within the right of way.

DIST.	COUNTY	ROUTE	POST MILES TOTAL PROJECT	SHEET NO.	TOTAL SHEETS

Signature
REGISTERED CIVIL ENGINEER

April 19, 2013
PLANS APPROVAL DATE

THE STATE OF CALIFORNIA ON ITS OFFICERS OR ARCHITS SHALL NOT BE RESPONSIBLE FOR THE ACCURACY OR COMPLETENESS OF ISSUED COPIES OF THIS PLAN SHEET.

TO ACCOMPANY PLANS DATED _____



TABLE 1

SPEED (S)	MINIMUM TAPER LENGTH * FOR WIDTH OF OFFSET 12 FEET (W)				MAXIMUM CHANNELIZING DEVICE SPACING		
	TANGENT 2L	MERGING L	SHIFTING L/2	SHOULDER L/3	X	Y	Z **
					TAPER	TANGENT	CONFLICT
mph	ff	ff	ff	ff	ff	ff	ff
20	160	80	40	27	20	40	10
25	250	125	63	42	25	50	12
30	360	180	90	60	30	60	15
35	490	245	123	82	35	70	17
40	640	320	160	107	40	80	20
45	1080	540	270	180	45	90	22
50	1200	600	300	200	50	100	25
55	1320	660	330	220	55	110	27
60	1440	720	360	240	60	120	30
65	1560	780	390	260	65	130	32
70	1680	840	420	280	70	140	35

* - For other offsets, use the following merging taper length formula for L:
 For speed of 40 mph or less, $L = WS^2/60$
 For speed of 45 mph or more, $L = WS$

Where: L = Taper length in feet
 W = Width of offset in feet
 S = Posted speed limit, off-peak 85th-percentile speed prior to work starting, or the anticipated operating speed in mph

** - Use for taper and tangent sections where there are no pavement markings or where there is a conflict between existing pavement markings and channelizers (CA).

TABLE 2

SPEED *	Min D **	DOWNGRADE Min D ***		
		-3%	-6%	-9%
		mph	ff	ff
20	115	116	120	126
25	155	158	165	173
30	200	205	215	227
35	250	257	271	287
40	305	315	333	354
45	360	378	400	427
50	425	446	474	507
55	495	520	553	593
60	570	598	638	686
65	645	682	728	785
70	730	771	825	891

* - Speed is posted speed limit, off-peak 85th-percentile speed prior to work starting, or the anticipated operating speed in mph

** - Longitudinal buffer space or flagger station spacing

*** - Use on sustained downgrade steeper than -3 percent and longer than 1 mile.

TABLE 3

ROAD TYPE	DISTANCE BETWEEN SIGNS *		
	A	B	C
	URBAN - 25 mph OR LESS	100	100
URBAN - MORE THAN 25 mph TO 40 mph	250	250	250
URBAN - MORE THAN 40 mph	350	350	350
RURAL	500	500	500
EXPRESSWAY / FREEWAY	1000	1500	2640

* - The distances are approximate, are intended for guidance purposes only, and should be applied with engineering judgment. These distances should be adjusted by the Engineer for field conditions, if necessary, by increasing or decreasing the recommended distances.

STATE OF CALIFORNIA
 DEPARTMENT OF TRANSPORTATION

**TRAFFIC CONTROL SYSTEM
 FOR LANE CLOSURE ON
 FREEWAYS AND EXPRESSWAYS**

NO SCALE

RSP T9 DATED APRIL 19, 2013 SUPPLEMENTS THE STANDARD PLANS BOOK DATED 2010.

REVISED STANDARD PLAN RSP T9

2010 REVISED STANDARD PLAN RSP T9

DIST	COUNTY	ROUTE	POST MILES	SHEET TOTAL
			TOTAL PROJECT	NO. SHEETS

REGISTERED CIVIL ENGINEER
 APR 19, 2013
 PLANS APPROVAL DATE
 THE STATE OF CALIFORNIA BY ITS OFFICERS AND AGENTS SHALL NOT BE RESPONSIBLE FOR THE ACCURACY OR COMPLETENESS OF THE COPIES OF THIS PLAN SHEET.

NOTES: TO ACCOMPANY PLANS DATED _____

See Revised Standard Plan RSP T9 for tables.

Use cone spacing X for taper segment, Y for tangent segment or Z for conflict situations, as appropriate, per Table 1, unless X, Y, or Z cone spacing is shown on this sheet.

Unless otherwise specified in the special provisions, all temporary warning signs shall have black legend on fluorescent orange background. California codes are designated by (CA). Otherwise, Federal (MUTCD) codes are shown.

SEE NOTE 5

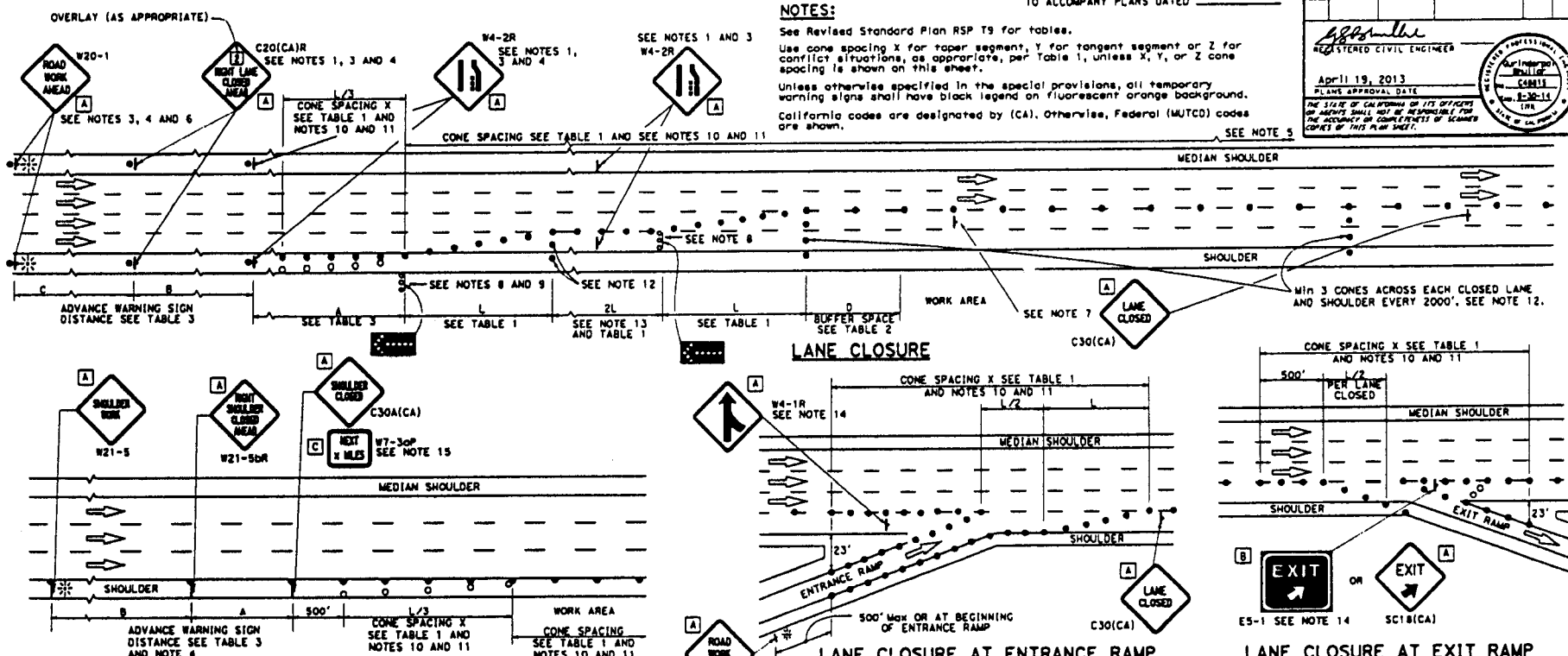

- NOTES:**
- Median lane closures shall conform to the details as shown except that C20(CA)L and W4-2L signs shall be used.
 - At least one person shall be assigned to provide full time maintenance of traffic control devices for lane closures.
 - Duplicate sign installations are not required:
 - On opposite shoulder if at least one-half of the available lanes remain open to traffic.
 - In the median if the width of the median shoulder is less than 8' and the outside lanes are to be closed.
 - Each advance warning sign on each side of the roadway shall be equipped with at least two flags for daytime closure. Each flag shall be at least 18" x 18" in size and shall be orange or fluorescent red-orange in color. Flashing beacons shall be placed at the locations indicated for lane closure during hours of darkness.
 - A G20-2 "END ROAD WORK" sign, with minimum size of 48" x 24" as appropriate, shall be placed at the end of the lane closure unless the end of work area is obvious or ends within a larger project's limits.

- SHOULDER CLOSURE**
- If the W20-1 sign would follow within 2000' of a stationary W20-1 or G20-1 "ROAD WORK NEXT _____ MILES", use a C20(CA) sign for the first advance warning sign.
 - Place a C30(CA) sign every 2000' throughout length of lane closure.
 - One flashing arrow sign for each lane closed. The flashing arrow signs shall be Type I.
 - A minimum 1500' of sight distance shall be provided where possible for vehicles approaching the first flashing arrow sign. Lane closures shall not begin at top of crest vertical curve or on a horizontal curve.
 - All cones used for lane closures during the hours of darkness shall be fitted with retroreflective bands (or sleeves) as specified in the specifications.
 - Portable delineators, placed at one-half the spacing indicated for traffic cones may be used instead of cones for daytime closures only.

- Unless otherwise specified in the special provisions, a minimum of 3 cones shall be placed transversely across each closed lane and shoulder at each location where a taper across a traffic lane ends and every 2000' as shown on the "Lane Closure" detail. Two Type I barricades may be used instead of the 3 cones. The transverse alignment of the cones or barricades on the closed shoulder may be shifted from the transverse alignment to provide access to the work.
- Unless otherwise specified in the special provisions, the 2L tangent shown along lane lines shall be used between the L tapers required for each closed traffic lane.
- Unless otherwise specified in the special provisions, the E5-1 or SC18(CA) and W4-1 signs shall be used as shown.
- A W7-3oP "NEXT _____ MILES" plaque must be used if the shoulder closure extends beyond the distance that can be perceived by road users.

- LEGEND**
- TRAFFIC CONE
 - TRAFFIC CONE (OPTIONAL TAPER)
 - ↓ TEMPORARY TRAFFIC CONTROL SIGN
 - ⬢ FLASHING ARROW SIGN (FAS)
 - ☞ FAS SUPPORT OR TRAILER
 - ☼ PORTABLE FLASHING BEACON

SIGN PANEL SIZE (Min)

A	48" x 48"
B	72" x 60"
C	36" x 30"

STATE OF CALIFORNIA
DEPARTMENT OF TRANSPORTATION

**TRAFFIC CONTROL SYSTEM
FOR LANE CLOSURE ON
FREEWAYS AND EXPRESSWAYS**

NO SCALE

RSP T10 DATED APRIL 19, 2013 SUPERSEDES STANDARD PLAN T10
DATED MAY 20, 2011 - PAGE 237 OF THE STANDARD PLANS BOOK DATED 2010.

REVISED STANDARD PLAN RSP T10

2010 REVISED STANDARD PLAN RSP T10A

NOTES: See Revised Standard Plan RSP T9 for tables. TO ACCOMPANY PLANS DATED _____

Use cone spacing X for taper segment, Y for tangent segment or Z for conflict situations, as appropriate, per Table 1, unless X, Y, or Z cone spacing is shown on this sheet.

Unless otherwise specified in the special provisions, all temporary warning signs shall have black legend on fluorescent orange background.

California codes are designated by (CA). Otherwise, Federal (MUTCD) codes are shown.

SEE NOTE 4

DIST	COUNTY	ROUTE	POST MILE	SHEET TOTAL
			TOTAL PROJECT	NO. SHEETS

 REGISTERED CIVIL ENGINEER
 APRIL 19, 2013
 PLANS APPROVAL DATE
 THE STATE OF CALIFORNIA AND ITS OFFICERS OR AGENCIES SHALL NOT BE RESPONSIBLE FOR THE ACCURACY OR COMPLETENESS OF TECHNICAL COPIES OF THIS PLAN SHEET.

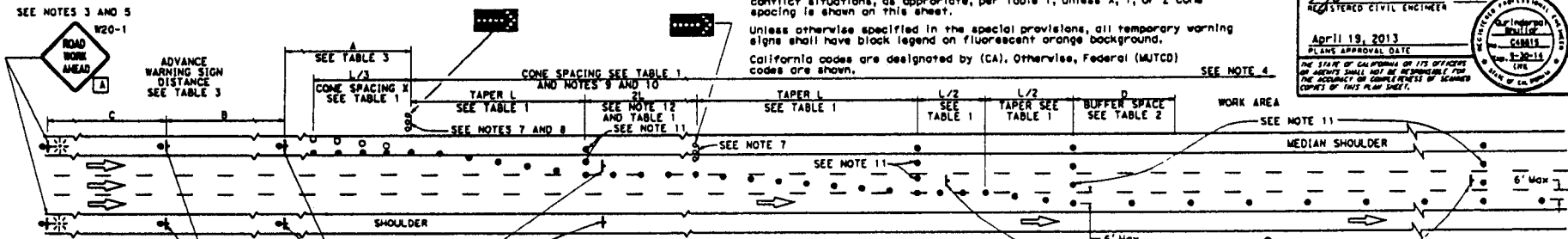

LANE CLOSURE WITH PARTIAL SHOULDER USE

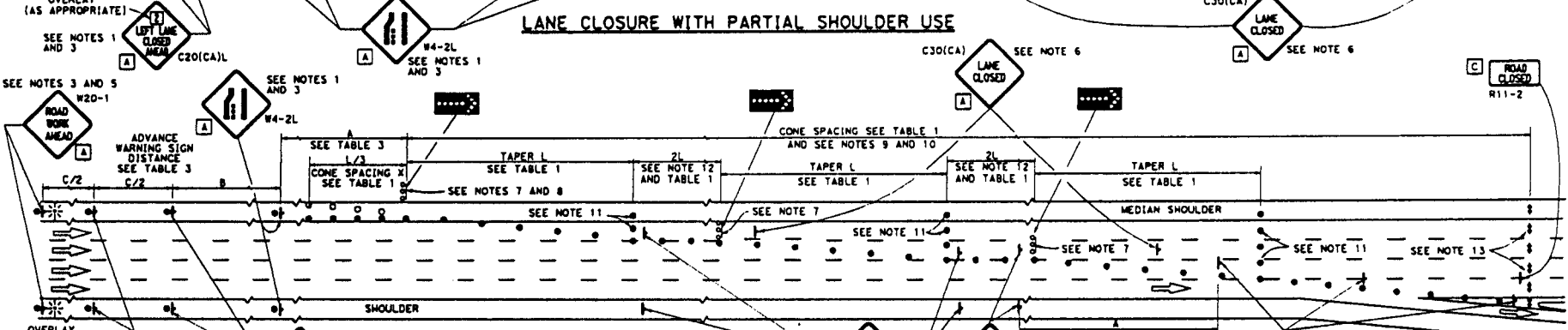

COMPLETE CLOSURE



- NOTES:**
- Lane closures on the right side using partial median shoulder as a traffic lane shall conform to the details as shown except that C20(CA)R and W4-2R signs shall be used.
 - At least one person shall be assigned to provide full time maintenance of traffic control devices for lane closures.
 - Each advance warning sign on each side of the roadway shall be equipped with at least two flags for daytime closures. Each flag shall be at least 16" x 16" in size and shall be orange or fluorescent red-orange in color. Flashing beacons shall be placed at the locations indicated for lane closure during hours of darkness.
 - A G20-2 "END ROAD WORK" sign, with minimum size of 48" x 24" as appropriate, shall be placed at the end of the lane closure unless the end of work area is obvious or ends within a larger project's limits.
 - If the W20-1 sign would follow within 2000' of a stationary W20-1 or G20-1 "ROAD WORK NEXT MILES", use a C20(CA) sign for the first advance warning sign.
 - Place a C30(CA) sign every 2000' throughout length of lane closure.

- One flashing arrow sign for each lane closed. The flashing arrow signs shall be Type I.
- A minimum 1500' of sight distance shall be provided where possible for vehicles approaching the first flashing arrow sign. Lane closures shall not begin at the top of crest vertical curve or on a horizontal curve.
- All cones used for lane closures during the hours of darkness shall be fitted with retroreflective bands (or sleeves) as specified in the specifications.
- Portable delineators, placed at one-half the spacing indicated for traffic cones, may be used instead of cones for daytime closures only.
- Unless otherwise specified in the special provisions, a minimum of 3 cones shall be placed transversely across each closed lane and shoulder at each location where a taper across a traffic lane ends and every 2000' as shown on the "Lane Closure With Partial Shoulder Use" detail. Two Type 3 barricades may be used instead of the 3 cones. The transverse alignment of the cones or barricades on the closed shoulder may be shifted from the transverse alignment to provide access to the work.

- Unless otherwise specified in the special provisions, the 2L tangent shown along lane lines shall be used between the L tapers required for each closed traffic lane.
- A minimum of two Type I or II barricades shall be placed across each closed lane and shoulder at the location shown and every 2000' within the complete closure area. Within the complete closure area, the transverse alignment of the barricades on the closed shoulder may be shifted from the transverse alignment to provide access to the work.
- When specified in the special provisions, a W20-2 "DETOUR AHEAD" sign is to be used in place of the W20-3 "FREEWAY CLOSED AHEAD" sign.

SIGN PANEL SIZE (Min)

- A 48" x 48"
- B 48" x 18"
- C 48" x 30"

- LEGEND**
- TRAFFIC CONE
 - TRAFFIC CONE (OPTIONAL TAPER)
 - ▬ TEMPORARY TRAFFIC CONTROL SIGN
 - ▬ FLASHING ARROW SIGN (FAS)
 - ▬ FAS SUPPORT OR TRAILER
 - ⊛ PORTABLE FLASHING BEACON

STATE OF CALIFORNIA
DEPARTMENT OF TRANSPORTATION
**TRAFFIC CONTROL SYSTEM
FOR LANE CLOSURES ON
FREEWAYS AND EXPRESSWAYS**
NO SCALE

RSP T10A DATED APRIL 19, 2013 SUPERSEDES STANDARD PLAN T10A DATED MAY 20, 2011 - PAGE 238 OF THE STANDARD PLANS BOOK DATED 2010.

REVISED STANDARD PLAN RSP T10A

DIST	COUNTY	ROUTE	POST MILES TOTAL PROJECT	SHEET TOTAL
				100 - 306/5



 REGISTERED CIVIL ENGINEER
 APRIL 19, 2013
 PLANS APPROVAL DATE
 THE STATE OF CALIFORNIA OR ITS OFFICERS OR AGENCIES SHALL NOT BE RESPONSIBLE FOR THE ACCURACY OR COMPLETENESS OF REPRODUCED COPIES OF THIS PLAN SHEET.

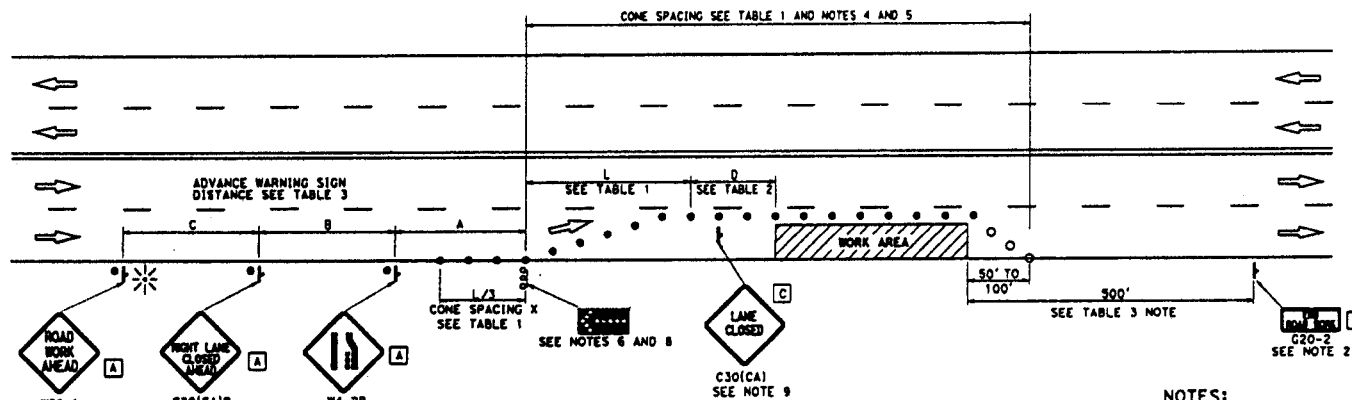

TYPICAL LANE CLOSURE

NOTES:

See Revised Standard Plan RSP T9 for tables.
 Use cone spacing X for taper segment, Y for tangent segment or Z for conflict situations, as appropriate, per Table 1, unless X, Y, or Z cone spacing is shown on this sheet.
 Unless otherwise specified in the special provisions, all temporary warning signs shall have black legend on fluorescent orange background.
 California codes are designated by (CA). Otherwise, Federal (MUTCD) codes are shown.

NOTES:

- Each advance warning sign shall be equipped with at least two flags for daytime closure. Each flag shall be at least 16" x 16" in size and shall be orange or fluorescent red-orange in color. Flashing beacons shall be placed at the locations indicated for lane closure during hours of darkness.
- A G20-2 "END ROAD WORK" sign, as appropriate, shall be placed at the end of the lane closure unless the end of work area is obvious, or ends within a larger project's limits.
- If the W20-1 sign would follow within 2000' of a stationary W20-1 or G20-1 "ROAD WORK NEXT MILES", use a C20(CA) sign for the first advance warning sign.
- All cones used for lane closures during the hours of darkness shall be fitted with retroreflective bands (or sleeves) as specified in the specifications.
- Portable delineators, placed at one-half the spacing indicated for traffic cones, may be used instead of cones for daytime closures only.
- Flashing arrow sign shall be either Type I or Type II.
- For approach speeds over 50 mph, use the "Traffic Control System for Lane Closure On Freeways And Expressways" plan for lane closure details and requirements.
- A minimum 1500' of sight distance shall be provided where possible for vehicles approaching the first flashing arrow sign. Lane closures shall not begin at the top of crest vertical curve or on a horizontal curve.
- Place a C30(CA) sign every 2000' throughout length of lane closure.
- Median lane closures shall conform to the details as shown except that C20(CA)IL and W4-2L signs shall be used.
- At least one person shall be assigned to provide full time maintenance of traffic control devices for lane closure unless, otherwise directed by the Engineer.

LEGEND

- TRAFFIC CONE
- TRAFFIC CONE (OPTIONAL TAPER)
- ↓ TEMPORARY TRAFFIC CONTROL SIGN
- ⬢ FLASHING ARROW SIGN (FAS)
- ▭ FAS SUPPORT OR TRAILER
- ⊛ PORTABLE FLASHING BEACON

SIGN PANEL SIZE (min)

- A 48" x 48"
- B 36" x 18"
- C 30" x 30"

STATE OF CALIFORNIA
 DEPARTMENT OF TRANSPORTATION
**TRAFFIC CONTROL SYSTEM
 FOR LANE CLOSURE ON
 MULTILANE CONVENTIONAL
 HIGHWAYS**
 NO SCALE

RSP T11 DATED APRIL 19, 2013 SUPERSEDES STANDARD PLAN T11
 DATED MAY 20, 2011 - PAGE 239 OF THE STANDARD PLANS BOOK DATED 2010.

REVISED STANDARD PLAN RSP T11

2010 REVISED STANDARD PLAN RSP T11

DIST	COUNTY	ROUTE	POST MILES TOTAL PROJECT	SHEET NO.	TOTAL SHEETS

REGISTERED CIVIL ENGINEER
APPROVED
 APRIL 19, 2013
 PLANS APPROVAL DATE
 THE STATE OF CALIFORNIA, BY ITS OFFICERS OF HIGHWAYS, SHALL NOT BE RESPONSIBLE FOR THE ACCURACY OR COMPLETENESS OF SCANNED COPIES OF THIS PLAN SHEET.

LEGEND

- TRAFFIC CONE
- TEMPORARY TRAFFIC CONTROL SIGN
- FLASHING ARROW SIGN (FAS)
- FAS SUPPORT OR TRAILER
- PORTABLE FLASHING BEACON

SIGN PANEL SIZE (Min)

- A 48" x 48"
- B 24" x 24"
- C 36" x 18"

NOTES:

See Revised Standard Plan RSP T9 for tables.
 Use cone spacing X for taper segment, Y for tangent segment or Z for conflict situations, as appropriate, per Table 1, unless X, Y, or Z cone spacing is shown on this sheet.
 Unless otherwise specified in the special provisions, all temporary warning signs shall have black legend on fluorescent orange background. California codes are designated by (CA). Otherwise, Federal (MUTCD) codes are shown.

TO ACCOMPANY PLANS DATED _____

TYPICAL HALF ROAD CLOSURE

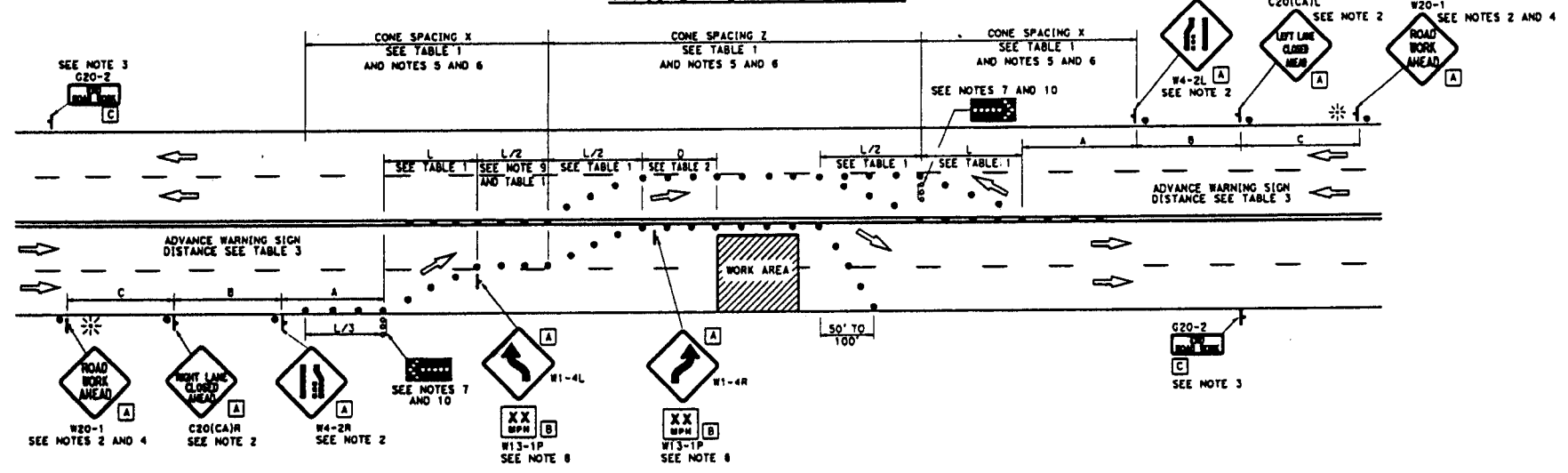

NOTES:

1. At least one person shall be assigned to provide full time maintenance of traffic control devices for lane closure unless, otherwise directed by the Engineer.
2. Each advance warning sign in each direction of travel shall be equipped with at least two flags for daytime closure. Each flag shall be at least 16" x 16" in size and shall be orange or fluorescent red-orange in color. Flashing beacons shall be placed at the locations indicated for lane closure during hours of darkness.
3. A G20-2 "END ROAD WORK" sign, as appropriate, shall be placed at the end of the lane closure unless the end of work area is obvious, or ends within a larger project's limits.
4. If the W20-1 sign would follow within 2000' of a stationary W20-1 or G20-1 "ROAD WORK NEXT MILES", use a C20(CA)R sign for the first advance warning sign.
5. All cones used for lane closures during the hours of darkness shall be fitted with retroreflective bands (or sleeves) as specified in the specifications.
6. Portable delineators, placed at one-half the spacing indicated for traffic cones, may be used instead of cones for daytime closures only.
7. Flashing arrow signs shall be either Type I or Type II.
8. Advisory speed will be determined by the Engineer. The W13-1P Plaque will not be required when advisory speed is more than the posted or maximum speed limit.
9. Unless otherwise specified in the special provisions, the tangent (L/2) shall be used.
10. A minimum 1500' of sight distance shall be provided where possible for vehicles approaching the first flashing arrow sign. Lane closures shall not begin at the top of crest vertical curve or on a horizontal curve.

2010 REVISED STANDARD PLAN RSP T12

STATE OF CALIFORNIA
 DEPARTMENT OF TRANSPORTATION
**TRAFFIC CONTROL SYSTEM
 FOR HALF ROAD CLOSURE ON
 MULTILANE CONVENTIONAL
 HIGHWAYS AND EXPRESSWAYS**
 NO SCALE

RSP T12 DATED APRIL 19, 2013 SUPERSEDES STANDARD PLAN T12
 DATED MAY 20, 2011 - PAGE 240 OF THE STANDARD PLANS BOOK DATED 2010.

REVISED STANDARD PLAN RSP T12

NOTES:

See Revised Standard Plan RSP T9 for tables.
 Use cone spacing X for taper segment, Y for tangent segment or Z for conflict situations, as appropriate, per Table 1, unless X, Y, or Z cone spacing is shown on this sheet.
 Unless otherwise specified in the special provisions, all temporary warning signs shall have black legend on fluorescent orange background.
 California codes are designated by (CA). Otherwise, Federal (MUTCD) codes are shown.

DIST.	COUNTY	ROUTE	POST MILES TOTAL PROJECT	SHEET TOTAL SHEETS

 REGISTERED CIVIL ENGINEER
 Phillip C. Ellis
 License No. 2-30-14
 State of California
 APR 19, 2013
 PLANS APPROVAL DATE
 THE STATE OF CALIFORNIA OR ITS OFFICERS OR AGENTS SHALL NOT BE RESPONSIBLE FOR THE ACCURACY OR COMPLETENESS OF SEPARATE COPIES OF THIS PLAN SHEET.

TYPICAL LANE CLOSURE WITH REVERSIBLE CONTROL

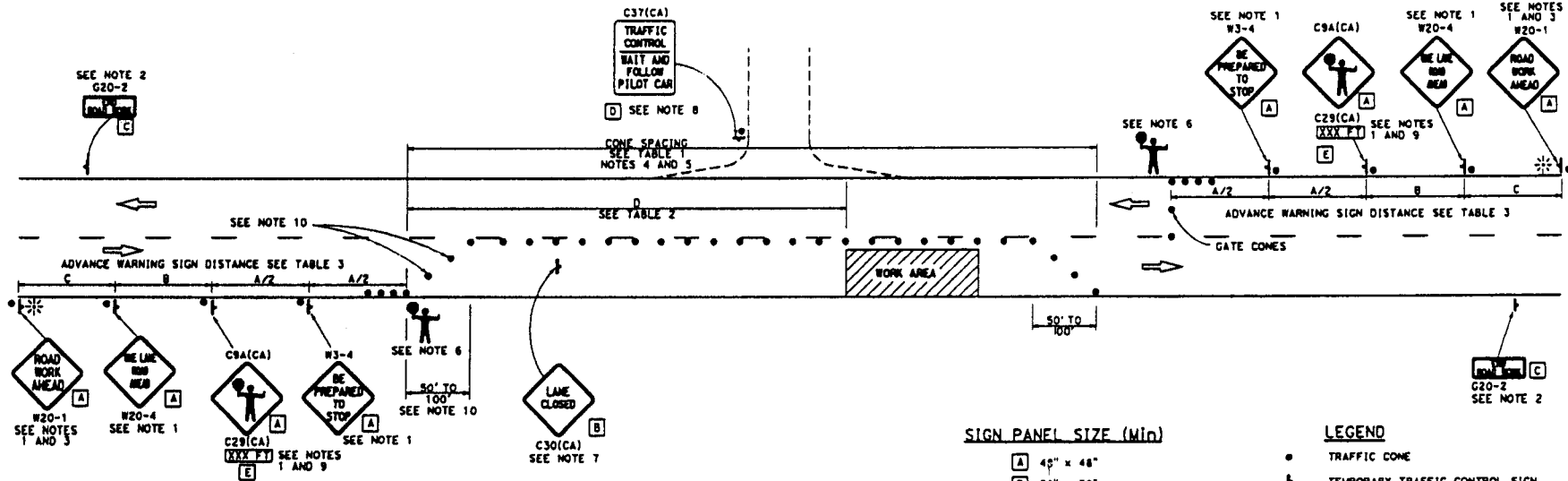





NOTES:

- Each advance warning sign in each direction of travel shall be equipped with at least two flags for daytime closure. Each flag shall be at least 16" x 16" in size and shall be orange or fluorescent red-orange in color. Flashing beacons shall be placed at the locations indicated for lane closure during hours of darkness.
- A G20-2 "END ROAD WORK" sign, as appropriate, shall be placed at the end of the lane control unless the end of work area is obvious, or ends within a larger project's limits.
- If the W20-1 sign would follow within 2000' of a stationary W20-1 or G20-1 "ROAD WORK NEXT" MILES, use a W20-4 sign for the first advance warning sign.
- All cones used for lane closures during the hours of darkness shall be fitted with retroreflective bands (or sleeves) as specified in the specifications.
- Portable delineators, placed at one-half the spacing indicated for traffic cones, may be used instead of cones for daytime closures only.
- Additional advance flaggers may be required. Flagger should stand in a conspicuous place, be visible to approaching traffic as well as approaching vehicles after the first vehicle has stopped. During the hours of darkness, the flagging station and flagger shall be illuminated and clearly visible to approaching traffic. The illumination footprint of the lighting on the ground shall be at least 20' in diameter. Place a minimum of four cones at 50' intervals in advance of flagger station as shown.
- Place C30(CA) "LANE CLOSED" sign at 500' to 1000' intervals throughout extended work areas. They are optional if the work area is visible from the flagger station.
- When a pilot car is used, place a C37(CA) "TRAFFIC CONTROL-WAIT AND FOLLOW PILOT CAR" sign with black legend on white background at all intersections, driveways and alleys without a flagger within traffic control area. Signs shall be clean and visible at all times. Where traffic can not be effectively self-regulated, at least one flagger shall be used at each intersection within traffic control area.
- An optional C29(CA) sign may be placed below the C9A(CA) sign.
- Either traffic cones or barricades shall be placed on the taper. Barricades shall be Type 1, 2, or 3L.

SIGN PANEL SIZE (Min)

A	48" x 48"
B	30" x 30"
C	36" x 18"
D	36" x 42"
E	20" x 7"

LEGEND

-  TRAFFIC CONE
-  TEMPORARY TRAFFIC CONTROL SIGN
-  PORTABLE FLASHING BEACON
-  FLAGGER

STATE OF CALIFORNIA
 DEPARTMENT OF TRANSPORTATION
**TRAFFIC CONTROL SYSTEM
 FOR LANE CLOSURE ON
 TWO LANE CONVENTIONAL
 HIGHWAYS**
 NO SCALE

RSP T13 DATED APRIL 19, 2013 SUPERSEDES STANDARD PLAN T13
 DATED MAY 20, 2011 - PAGE 241 OF THE STANDARD PLANS BOOK DATED 2010.

REVISED STANDARD PLAN RSP T13

2010 REVISED STANDARD PLAN RSP T13

TYPICAL RAMP CLOSURES

SIGN PANEL SIZE (Min)

- A 48" x 48"
- B 48" x 30"
- C 36" x 36"
- D 48" x 36"

LEGEND

- TRAFFIC CONE
- ⬇ TEMPORARY TRAFFIC CONTROL SIGN
- ⚡ BARRICADES
- ⚡ PORTABLE FLASHING BEACON

DIST.	COUNTY	ROUTE	POST MILES	SHEET TOTAL
			TOTAL PROJECT	NO. SHEETS

Signature
 REGISTERED CIVIL ENGINEER
 April 19, 2013
 PLANS APPROVAL DATE
 THE STATE OF CALIFORNIA ON ITS OFFICIAL SEAL SHALL NOT BE RESPONSIBLE FOR THE ACCURACY OR COMPLETENESS OF DRAWING CONTENTS OF THIS PLAN SHEET.
 REGISTERED PROFESSIONAL ENGINEER
 Srinivasan Mullig
 No. 23011
 CIVIL
 STATE OF CALIFORNIA

TO ACCOMPANY PLANS DATED _____

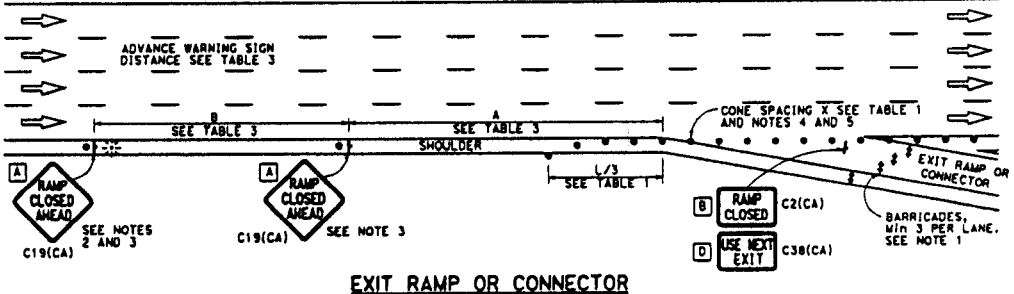

EXIT RAMP OR CONNECTOR

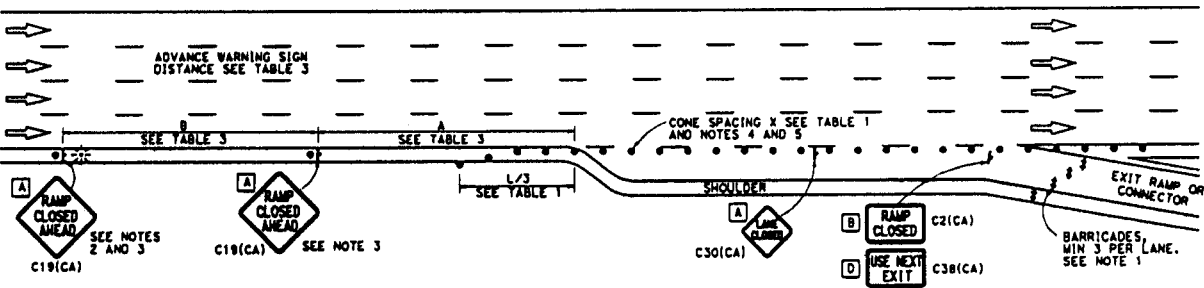

EXIT RAMP OR CONNECTOR WITH ADDITIONAL LANE

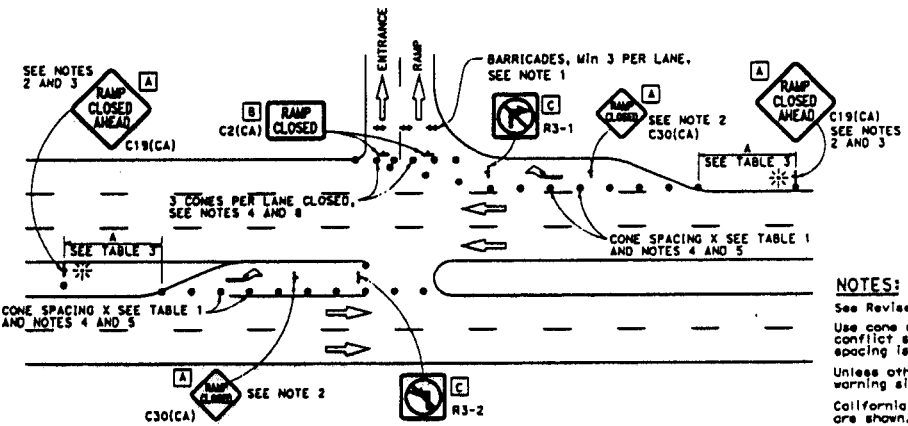

ENTRANCE RAMP WITH TURNING POCKETS

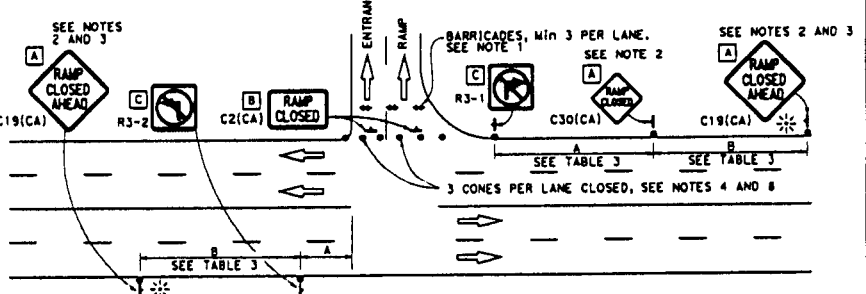

ENTRANCE RAMP WITHOUT TURNING POCKETS

NOTES:

1. See Revised Standard Plan RSP T9 for tables.
2. Use cone spacing X for taper segment, Y for tangent segment or Z for conflict situations, as appropriate, per Table 1, unless X, Y, or Z cone spacing is shown on this sheet.
3. Unless otherwise specified in the special provisions, all temporary warning signs shall have black legend on fluorescent orange background.
4. California codes are designated by (CA). Otherwise, Federal (MUTCD) codes are shown.

RSP T14 DATED APRIL 19, 2013 SUPERSEDES STANDARD PLAN T14 DATED MAY 20, 2011 - PAGE 242 OF THE STANDARD PLANS BOOK DATED 2010.

REVISED STANDARD PLAN RSP T14

STATE OF CALIFORNIA
 DEPARTMENT OF TRANSPORTATION
**TRAFFIC CONTROL SYSTEM
 FOR RAMP CLOSURE**
 NO SCALE

2010 REVISED STANDARD PLAN RSP T14

DIST.	COUNTY	ROUTE	POST MILES TOTAL PROJECT	SHEET NO.	TOTAL SHEETS

REGISTERED CIVIL ENGINEER
 April 19, 2013
 PLANS APPROVAL DATE
 THE STATE OF CALIFORNIA OR ITS OFFICERS OR AGENTS SHALL NOT BE RESPONSIBLE FOR THE ACCURACY OR COMPLETENESS OF SCANNED COPIES OF THIS PLAN SHEET.

TO ACCOMPANY PLANS DATED _____

2010 REVISED STANDARD PLAN RSP T15

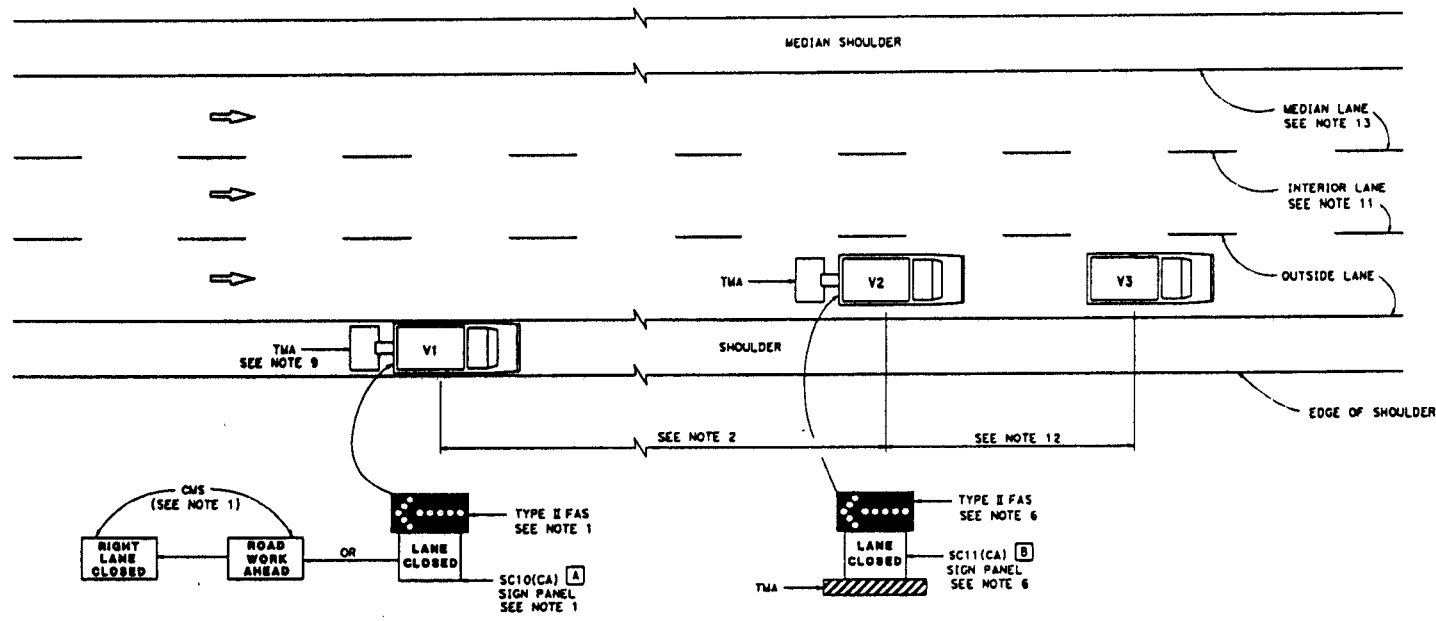

SIGN PANEL SIZE (Min)

- A 66" x 36"
- B 54" x 42"

LEGEND

- V1 SIGN VEHICLE
- V2 SHADOW VEHICLE
- V3 WORK/APPLICATION VEHICLE
- FLASHING ARROW SIGN (FAS)
- CMS CHANGEABLE MESSAGE SIGN
- TMA TRUCK-MOUNTED ATTENUATOR

MOVING LANE CLOSURE ON MEDIAN LANE OR OUTSIDE LANE OF MULTILANE HIGHWAYS

NOTES:

1. Either a changeable message sign or a SC10(CA) sign panel and a Type II flashing arrow sign shall be mounted on the rear of sign vehicle V1. The changeable message sign shall be sequenced to show the "ROAD WORK AHEAD" message first, followed by the "RIGHT LANE CLOSED" message. For median lane closure, the flashing arrow symbol shall be reversed with the arrowhead on the right and the changeable message sign shall show "LEFT LANE CLOSED".
2. If traffic queues develop, sign vehicle V1 should be positioned upstream from the end of queue. Sign vehicle V1 shall be positioned where highly visible when shoulders are not available.
3. A minimum sight distance of 1500' should be provided in advance of sign vehicle V1.
4. Sign vehicle V1 should remain at the beginning of horizontal or vertical curves until the other vehicles (V2 and V3) are far enough beyond the curve to resume the minimum sight distance of 1500'.
5. Vehicle-mounted sign panels shall have Type III or above retroreflective sheeting, black on white, or black on fluorescent orange, with 6" minimum series D letters per Caltrans sign specifications.
6. Shadow vehicle V2 shall be equipped with a truck-mounted attenuator. The sign panel shown and a Type II flashing arrow sign shall be mounted on the rear of shadow vehicle V2. For median lane closure the flashing arrow sign symbol shall be displayed with the arrowhead on the right.
7. All vehicles used for lane closures shall be equipped with two-way radios, and the vehicle operators shall maintain communication during the work or application operation.
8. All vehicles shall be equipped with flashing or rotating amber lights.
9. If sign vehicle V1 encroaches into the traffic lane due to insufficient shoulder width, sign vehicle V1 shall be equipped with a truck-mounted attenuator. Sign vehicle V1 shall stay as close to the edge of shoulder as practicable.
10. Where workers would be on foot in the work area, a stationary type lane closure (Revised Standard Plan T10, T11, etc., as applicable) shall be used instead of this plan.
11. For moving lane closure on interior lane of multilane highways, use Revised Standard Plan T16.
12. The spacing between work vehicle(s) and the shadow vehicles, and between each shadow vehicle should be minimized to deter road users from driving in between.
13. When the work/application vehicle V3 occupies the median lane, sign vehicle V1 should drive in the median shoulder and indicate left lane closed ahead.

STATE OF CALIFORNIA
DEPARTMENT OF TRANSPORTATION

TRAFFIC CONTROL SYSTEM FOR MOVING LANE CLOSURE ON MULTILANE HIGHWAYS
NO SCALE

RSP T15 DATED APRIL 19, 2013 SUPERSEDES STANDARD PLAN T15 DATED MAY 20, 2011 - PAGE 243 OF THE STANDARD PLANS BOOK DATED 2010.

REVISED STANDARD PLAN RSP T15

DIST	COUNTY	ROUTE	POST MILES TOTAL PROJECT	SHEET NO.	TOTAL SHEETS

REGISTERED CIVIL ENGINEER
 APRIL 19, 2013
 PLANS APPROVAL DATE
 THE STATE OF CALIFORNIA BY ITS OFFICERS
 OR AGENTS SHALL NOT BE RESPONSIBLE FOR
 THE ACCURACY OR CONSEQUENTS OF SCHEMED
 COPIES OF THIS PLAN SHEET.

TO ACCOMPANY PLANS DATED _____

SIGN PANEL SIZE (Min)

A 54" x 42"

LEGEND

- V1 SIGN VEHICLE
- V2 SHADOW VEHICLE
- V3 WORK/APPLICATION VEHICLE
- FLASHING ARROW SIGN (FAS) IN FLASHING DOUBLE ARROW MODE
- CMS CHANGEABLE MESSAGE SIGN
- TMA TRUCK-MOUNTED ATTENUATOR

STATE OF CALIFORNIA
DEPARTMENT OF TRANSPORTATION
**TRAFFIC CONTROL SYSTEM
FOR MOVING LANE CLOSURE
ON MULTILANE HIGHWAYS**
NO SCALE

RSP T16 DATED APRIL 19, 2013 SUPERSEDES STANDARD PLAN T16
DATED MAY 20, 2011 - PAGE 244 OF THE STANDARD PLANS BOOK DATED 2010.

REVISED STANDARD PLAN RSP T16

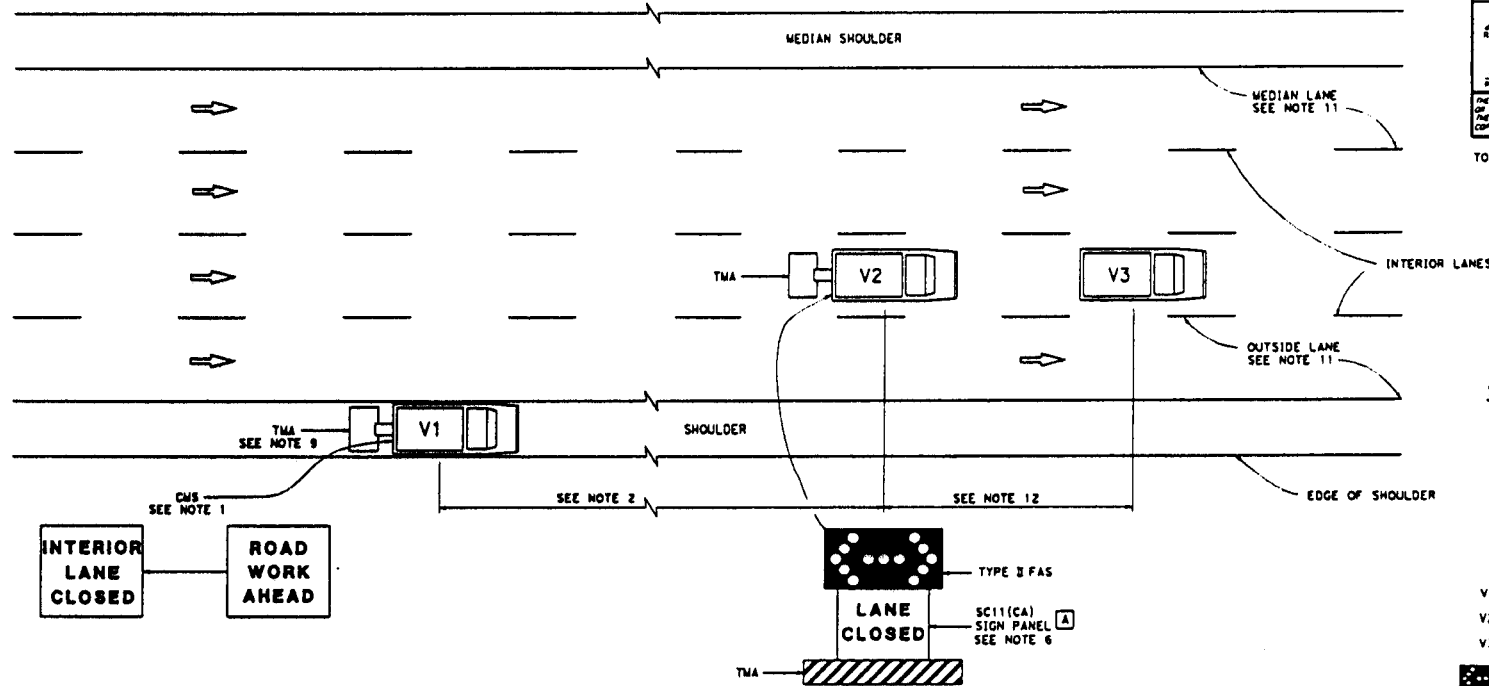

2010 REVISED STANDARD PLAN RSP T16



**MOVING LANE CLOSURE ON INTERIOR
LANE OF MULTILANE HIGHWAYS**

NOTES:

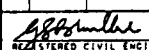
1. A changeable message sign shall be mounted on the rear of sign vehicle V1. The changeable message sign shall be sequenced to show the "ROAD WORK AHEAD" message first, followed by the "INTERIOR LANE CLOSED" message. The message "CENTER LANE CLOSED" may be used in place of the "INTERIOR LANE CLOSED" message.
2. If traffic queues develop, sign vehicle V1 should be positioned upstream from the end of queue. Sign vehicle V1 shall be positioned where highly visible when shoulders are not available.
3. A minimum sight distance of 1500' should be provided in advance of sign vehicle V1.
4. Sign vehicle V1 should remain at the beginning of horizontal or vertical curves until the other vehicles (V2 and V3) are far enough beyond the curve to resume the minimum sight distance of 1500'.
5. Vehicle-mounted sign panels shall have Type III or above retroreflective sheeting, black on white, or black on fluorescent orange, with 6" minimum series D letters per Caltrans sign specifications.
6. Shadow vehicle V2 shall be equipped with a truck-mounted attenuator. The sign panel shown and a Type II flashing arrow sign shall be mounted on the rear of shadow vehicle V2.
7. All vehicles used for lane closures shall be equipped with two-way radios, and the vehicle operators shall maintain communication during the work or application operation.
8. All vehicles shall be equipped with flashing or rotating amber lights.
9. If sign vehicle V1 encroaches into the traffic lane due to insufficient shoulder width, sign vehicle V1 shall be equipped with a truck-mounted attenuator. Sign vehicle V1 shall stay as close to the edge of shoulder as practicable.
10. Where workers would be on foot in the work area, a stationary type lane closure (Revised Standard Plan T10, T11 etc., as applicable) shall be used instead of this plan.
11. For moving lane closure on median lane or outside lane of multilane highways, use Revised Standard Plan T15.
12. The spacing between work vehicle(s) and the shadow vehicles, and between each shadow vehicle should be minimized to deter road users from driving in between.

0:00	COUNTY	ROUTE	POST MILES TOTAL PROJECT	SHEET TOTALS
				NO. SHEETS
 REGISTERED CIVIL ENGINEER				
April 19, 2013 PLANS APPROVAL DATE				
				
<small>THE STATE OF CALIFORNIA AND ITS OFFICERS OR AGENTS SHALL NOT BE RESPONSIBLE FOR THE ACCURACY OR COMPLETENESS OF SCANNED COPIES OF THIS PLAN SHEET.</small>				

TO ACCOMPANY PLANS DATED _____

2010 REVISED STANDARD PLAN RSP T17

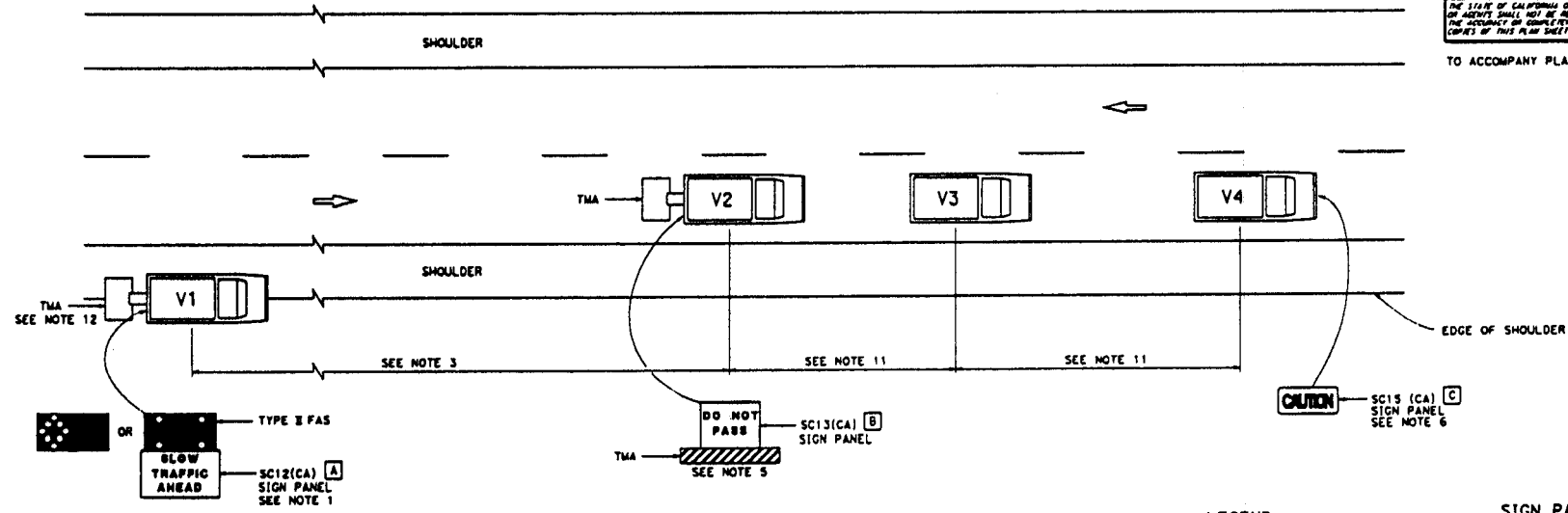



NOTES:

1. Either a changeable message sign or a SC12(CA) "SLOW TRAFFIC AHEAD" sign shall be mounted on the rear of sign vehicle V1. The changeable message sign shall be sequenced to show the "CAUTION" message first, follow by the "SLOW TRAFFIC AHEAD" message. A Type II flashing arrow sign may be used with the SC12(CA) sign panel.
2. Sign vehicle V1 should be positioned where highly visible when shoulders are not available.
3. If traffic queues develop, sign vehicle V1 should be positioned upstream from the end of queue.
4. Vehicle-mounted sign panels shall have Type III or above retroreflective sheeting, black on white, or black on fluorescent orange, with 6" minimum series D letters per Caltrans sign specifications.
5. Shadow vehicle shall be equipped with a truck-mounted attenuator. The sign panel shown shall be mounted on the rear of shadow vehicle V2. The message "LANE CLOSED" may be used in place of the "DO NOT PASS" message.
6. The sign panel shown shall be mounted on the front of sign vehicle V4, facing opposing traffic.

7. All vehicles shall be equipped with flashing or rotating amber lights.
8. Sign vehicle V4 will not be required when the work and vehicles V2 and V3 are 2' or more from the centerline of the highway during the work or application operations.
9. All vehicles used for lane closures shall be equipped with two-way radios and the vehicle operators shall maintain communication during the work or application operation.
10. This plan shall not be used where workers would be on foot in the work area. Use a stationary type lane closure (Revised Standard Plan T13) for this condition.
11. Minimize spacing between vehicles V2 and V3 and vehicles V3 and V4 to deter road users from driving in between them.
12. If sign vehicle V1 encroaches into the traffic lane due to insufficient shoulder width, sign vehicle V1 shall be equipped with a truck-mounted attenuator. Sign vehicle V1 shall stay as close to the edge of shoulder as practicable.

LEGEND

- V1 SIGN VEHICLE
- V2 SHADOW VEHICLE
- V3 WORK/APPLICATION VEHICLE
- V4 SIGN VEHICLE
- TMA TRUCK-MOUNTED ATTENUATOR
-  FLASHING ARROW SIGN (FAS) IN FLASHING CAUTION MODE
-  FLASHING ARROW SIGN (FAS) IN ALTERNATING DIAMOND CAUTION

SIGN PANEL SIZE (min)

- A 72" x 42"
- B 54" x 42"
- C 54" x 24"

STATE OF CALIFORNIA
DEPARTMENT OF TRANSPORTATION
**TRAFFIC CONTROL SYSTEM
FOR MOVING LANE CLOSURE
ON TWO LANE HIGHWAYS**
NO SCALE

RSP T17 DATED APRIL 19, 2013 SUPERSEDES STANDARD PLAN T17
DATED MAY 20, 2011 - PAGE 245 OF THE STANDARD PLANS BOOK DATED 2010.

REVISED STANDARD PLAN RSP T17

COMPLETING BID IN PENCIL, ERASURES, OVERWRITES, AND USE OF CORRECTION FLUID OR TAPE ARE NOT ACCEPTABLE. BID PROPOSALS WITH PENCIL, ERASURES, OVERWRITES, OR USE OF CORRECTION FLUID OR TAPE WILL BE REJECTED. ALL CHANGES MUST BE LINED OUT AND CORRECTIONS INSERTED ADJACENT TO AND INITIALED BY THE BIDDER'S AUTHORIZED REPRESENTATIVE.

PROPOSAL

(to be attached to and submitted with this bound Contract Document bid package)

TO: COUNTY OF EL DORADO,
STATE OF CALIFORNIA
COMMUNITY DEVELOPMENT AGENCY
TRANSPORTATION DIVISION

for the construction of the

U.S. 50 / SILVA VALLEY PARKWAY INTERCHANGE- PHASE 1 PROJECT

CONTRACT No. PW 12-30647 / CIP No. 71328

NAME OF BIDDER _____

BUSINESS P.O. BOX _____

CITY, STATE, ZIP _____

BUSINESS STREET ADDRESS _____

(Please include even if P.O. Box used)

CITY, STATE, ZIP _____

TELEPHONE NO: AREA CODE () _____

FAX NO: AREA CODE () _____

EMAIL ADDRESS _____

The work for which this Proposal is submitted is for the construction in accordance with these Contract Documents (including the payment of not less than the State general prevailing wage rates set forth herein), the Project Plans described below, including any addenda thereto, the Contract annexed hereto, and also in accordance with the California

U.S. 50 / SILVA VALLEY PARKWAY INTERCHANGE – PHASE 1
Contract No. PW 12-30647 / CIP No. 71328
Addendum No. 1

County of El Dorado
Proposal
Page P-1

Department of Transportation Standard Plans 2010, the Standard Specifications 2010, Revised Standard Specifications, standard drawings from the Design and Improvement Standards Manual of the County of El Dorado, revised March 8, 1994 including Resolutions 199-91 and 58-94 to adopt changes to the Design and Improvement Standards Manual; EID Design and Construction Standards, the Labor Surcharge and Equipment Rental Rates in effect on the date the work is accomplished, and in accordance with the General Prevailing Wage rates. The Project Plans and Contract Documents for the work to be done are entitled:

U.S. 50 / SILVA VALLEY PARKWAY INTERCHANGE – PHASE 1 PROJECT

CONTRACT No. PW 12-30647 / CIP No. 71328

Bids are to be submitted for the entire work. The amount of the bid for comparison purposes will be the total of all the items.

The Bidder shall set forth for each unit basis item of work a unit price and a total for the item, and for each lump sum item a total for the item, all in clearly legible figures in the respective spaces provided for this purpose. In the case of unit basis items, the amount set forth under the "Item Total" column shall be the product of the unit price bid and the estimated quantity for the item.

In case of discrepancy between the item price and the total set forth for a unit basis item, the unit price shall prevail, except as provided in (a) or (b), as follows:

- (a) If the amount set forth as a unit price is unreadable or otherwise unclear, or is omitted, or is the same as the amount as the entry in the item total column, then the amount set forth in the total column for the item shall prevail and shall be divided by the estimated quantity for the item and the price thus obtained shall be the unit price;
- (b) (Decimal Errors) If the product of the entered unit price and the estimated quantity is exactly off by a factor of ten, one hundred, etc., or one-tenth, or one-hundredth, etc., from the entered total, the discrepancy will be resolved by using the entered unit price or item total, whichever most closely approximates percentage wise the unit price or item total in the Community Development Agency, Transportation Division's Final Estimate of cost.

If this Proposal is accepted and the undersigned Bidder shall fail to enter into the Contract and furnish the two bonds in the sums required by the State Contract Act, with surety satisfaction to the County of El Dorado and submit escrow bid documents in accordance with the Special Provisions within ten (10) days, not including Saturdays, Sundays, and legal holidays, of the date of the letter notice from the County of El Dorado that the Contract has been awarded, the County of El Dorado may, at its option, determine that the Bidder has abandoned the Contract, and thereupon this Proposal and the acceptance thereof shall be null and void and the forfeiture of such security accompanying this Proposal shall operate and the same shall be the property of the County of El Dorado.

The undersigned, as Bidder, declares under penalty of perjury under the laws of the State of California that the only persons or parties interested in this Proposal, as principals, are those named herein; that this Proposal is made without collusion with any other person, firm, or corporation; that it has carefully examined the location of the proposed work, the annexed proposed form of Contract, and the Plans therein referred to; and that it proposes, and agrees if this Proposal is accepted, that it will contract with the County of El Dorado, in the form of the copy of the Draft Contract annexed hereto, to provide all necessary machinery, tools, apparatus, and other means of construction, and to do all the work and furnish all the materials specified in the Contract, in the manner and time therein prescribed, and according to the requirements of the Engineer as therein set forth, and that it will take in full payment therefore the following item prices, to wit:

PROPOSAL PAY ITEMS AND BID PRICE SCHEDULE

U.S. 50 / SILVA VALLEY PARKWAY INTERCHANGE – PHASE 1 PROJECT

CONTRACT NO. PW 12-30647 / CIP NO. 71328

ITEM NO.	ITEM	P-F	DESCRIPTION	UNIT	ESTIMATED QUANTITY	ITEM PRICE	TOTAL
1	072007		EXCAVATION SAFETY	LS	1		
2	070030		LEAD COMPLIANCE PLAN	LS	1		
3	080050		PROGRESS SCHEDULE (CRITICAL PATH METHOD)	LS	1		
4	120090		CONSTRUCTION AREA SIGNS	LS	1		
5	120100		TRAFFIC CONTROL SYSTEM	LS	1		
6	120120		TYPE III BARRICADE	EA	60		
7	120149		TEMPORARY PAVEMENT MARKING (PAINT)	SF	100		
8	120159		TEMPORARY TRAFFIC STRIPE (PAINT)	LF	5,490		
9	120165		CHANNELIZER (SURFACE MOUNTED)	EA	110		
10	120199		TRAFFIC PLASTIC DRUM	EA	200		
11	120300		TEMPORARY PAVEMENT MARKER	EA	200		
12	128650		PORTABLE CHANGEABLE MESSAGE SIGN	SWD	400		
13	129000		TEMPORARY RAILING (TYPE K)	LF	16,100		
14	129100		TEMPORARY CRASH CUSHION MODULES	EA	140		
15	129110A		TEMPORARY CRASH CUSHION (TYPE ABSORB 350)	EA	4		
16	130100		JOB SITE MANAGEMENT	LS	1		
17	130300		PREPARE STORM WATER POLLUTION PREVENTION PLAN	LS	1		
18	130310		RAIN EVENT ACTION PLAN	EA	53	500.00	26,500
19	130320		STORM WATER SAMPLING AND ANALYSIS DAY	EA	52		
20	130330		STORM WATER ANNUAL REPORT	EA	2	2000.00	4,000

ITEM NO.	ITEM	P-F	DESCRIPTION	UNIT	ESTIMATED QUANTITY	ITEM PRICE	TOTAL
21	141000		TEMPORARY FENCE (TYPE ESA)	LF	5,800		
22	149001A		ASBESTOS DUST MITIGATION PLAN	LS	1		
23	150204A		ABANDON UNDER DRAIN	LF	3,280		
24	150605		REMOVE FENCE	LF	12,700		
25	150662		REMOVE METAL BEAM GUARD RAILING	LF	570		
26	150668		REMOVE FLARED END SECTION	EA	5		
27	150714		REMOVE THERMOPLASTIC TRAFFIC STRIPE	LF	3,030		
28	150715		REMOVE THERMOPLASTIC PAVEMENT MARKING	SF	300		
29	150722		REMOVE PAVEMENT MARKER	EA	44		
30	150742		REMOVE ROADSIDE SIGN	EA	21		
31	150771		REMOVE HOT MIX ASPHALT DIKE	LF	1,300		
32	150809		REMOVE CULVERT	LF	470		
33	150814		REMOVE DOWNDRAIN	LF	130		
34	150819		REMOVE REINFORCED CONCRETE BOX CULVERT	LS	1		
35	150820		REMOVE INLET	EA	3		
36	150860		REMOVE BASE AND SURFACING	CY	2,100		
37	152390		RELOCATE ROADSIDE SIGN	EA	10		
38	152394		RELOCATE SIGN STRUCTURE	EA	1		
39	153103		COLD PLANE ASPHALT CONCRETE PAVEMENT	SY	13,800		
40	153130		REMOVE CONCRETE CURB	LF	120		
41	153221		REMOVE CONCRETE BARRIER	LF	540		

ITEM NO.	ITEM	P-F	DESCRIPTION	UNIT	ESTIMATED QUANTITY	ITEM PRICE	TOTAL
42	160102		CLEARING AND GRUBBING	LS	1		
43	160120		REMOVE TREE	EA	140		
44	170101		DEVELOP WATER SUPPLY	LS	1		
45	190101	F	ROADWAY EXCAVATION	CY	231,000		
46	192003	F	STRUCTURE EXCAVATION (BRIDGE)	CY	4,134		
47	192020	F	STRUCTURE EXCAVATION (TYPE D)	CY	199		
48	192037	F	STRUCTURE EXCAVATION (RETAINING WALL)	CY	900		
49	193003	F	STRUCTURE BACKFILL (BRIDGE)	CY	2,876		
50	193013	F	STRUCTURE BACKFILL (RETAINING WALL)	CY	1,400		
51	198010	F	IMPORTED BORROW (CY)	CY	122,000		
52	200117		DECOMPOSED GRANITE (MISCELLANEOUS AREA)	SF	290		
53	203018A		BIOSWALE	SY	1,750		
54	208738	F	8" CORRUGATED HIGH DENSITY POLYETHYLENE PIPE CONDUIT	LF	1,263		
55	210010		MOVE-IN/MOVE-OUT (EROSION CONTROL)	EA	4		
56	210280		ROLLED EROSION CONTROL PRODUCT (BLANKET) TYPE B	SY	1,540		
57	210350		FIBER ROLLS	LF	95,800		
58	210430		HYDROSEED	SY	231,000		
59	210600A		COMPOST (INCORPORATE)	SY	1,140		
60	260203		CLASS 2 AGGREGATE BASE	CY	43,300		
61	377501		SLURRY SEAL	TON	38		
62	390132		HOT MIX ASPHALT (TYPE A)	TON	35,000		

ITEM NO.	ITEM	P-F	DESCRIPTION	UNIT	ESTIMATED QUANTITY	ITEM PRICE	TOTAL
63	390138		RUBBERIZED HOT MIX ASPHALT (OPEN GRADED)	TON	2,770		
64	394050		RUMBLE STRIP	STA	140		
65	394074		PLACE HOT MIX ASPHALT DIKE (TYPE C)	LF	960		
66	394076		PLACE HOT MIX ASPHALT DIKE (TYPE E)	LF	7,400		
67	394077		PLACE HOT MIX ASPHALT DIKE (TYPE F)	LF	5,300		
68	394090		PLACE HOT MIX ASPHALT (MISCELLANEOUS AREA)	SY	1,810		
69	477020	P-F	MECHANICALLY STABILIZED EMBANKMENT	SF	2,880		
70	498052		60" CAST-IN-DRILLED-HOLE CONCRETE PILE (SIGN FOUNDATION)	LF	290		
71	500001	P	PRESTRESSING CAST-IN-PLACE CONCRETE	LS	1		
72	510051	F	STRUCTURAL CONCRETE, BRIDGE FOOTING	CY	709		
73	510053	F	STRUCTURAL CONCRETE, BRIDGE	CY	4,668		
74	510060	F	STRUCTURAL CONCRETE, RETAINING WALL	CY	440		
75	510072	F	STRUCTURAL CONCRETE, BARRIER SLAB	CY	112		
76	510086	F	STRUCTURAL CONCRETE, APPROACH SLAB (TYPE N)	CY	520		
77	510090	F	STRUCTURAL CONCRETE, BOX CULVERT	CY	632		
78	510501A	F	MINOR CONCRETE (MEDIAN)	CY	49		
79	510502	F	MINOR CONCRETE (MINOR STRUCTURE)	CY	70		
80	510526	F	MINOR CONCRETE (BACKFILL)	CY	47		
81	511035A	F	ARCHITECTURAL TREATMENT (DRY STACK ROCK TEXTURE)	SF	6,166		
82	519088A	P	JOINT SEAL (TYPE B - MR 1")	LF	180		
83	519100	P	JOINT SEAL (MR 2")	LF	298		

ITEM NO.	ITEM	P-F	DESCRIPTION	UNIT	ESTIMATED QUANTITY	ITEM PRICE	TOTAL
84	519200		PRECAST BRIDGE SYSTEM	LS	1		
85	520102	P-F	BAR REINFORCING STEEL (BRIDGE)	LB	1,274,872		
86	520103	P-F	BAR REINFORCING STEEL (RETAINING WALL)	LB	52,000		
87	520107	P-F	BAR REINFORCING STEEL (BOX CULVERT)	LB	122,687		
88	520120	P-F	HEADED BAR REINFORCEMENT	EA	300		
89	560203	F	FURNISH SIGN STRUCTURE (BRIDGE MOUNTED WITH WALKWAY)	LB	6,247		
90	560204	F	INSTALL SIGN STRUCTURE (BRIDGE MOUNTED WITH WALKWAY)	LB	6,247		
91	560218	F	FURNISH SIGN STRUCTURE (TRUSS)	LB	206,000		
92	560219	F	INSTALL SIGN STRUCTURE (TRUSS)	LB	206,000		
93	560244		FURNISH LAMINATED PANEL SIGN (1"-TYPE A)	SF	3,160		
94	560245		FURNISH LAMINATED PANEL SIGN (1"-TYPE B)	SF	110		
95	560248		FURNISH SINGLE SHEET ALUMINUM SIGN (0.063"-UNFRAMED)	SF	650		
96	560249		FURNISH SINGLE SHEET ALUMINUM SIGN (0.080"-UNFRAMED)	SF	440		
97	560251		FURNISH SINGLE SHEET ALUMINUM SIGN (0.063"-FRAMED)	SF	94		
98	560252		FURNISH SINGLE SHEET ALUMINUM SIGN (0.080"-FRAMED)	SF	100		
99	566011		ROADSIDE SIGN - ONE POST	EA	84		
100	566012		ROADSIDE SIGN - TWO POST	EA	9		
101	568001		INSTALL SIGN (STRAP AND SADDLE BRACKET METHOD)	EA	20		
102	568001A		INSTALL SIGN (BARRICADE MOUNTED)	EA	2		
103	568016		INSTALL SIGN PANEL ON EXISTING FRAME	SF	480		

ITEM NO.	ITEM	P-F	DESCRIPTION	UNIT	ESTIMATED QUANTITY	ITEM PRICE	TOTAL
104	620100	P	18" ALTERNATIVE PIPE CULVERT	LF	1,520		
105	620140	P	24" ALTERNATIVE PIPE CULVERT	LF	630		
106	620220	P	36" ALTERNATIVE PIPE CULVERT	LF	120		
107	650010	P	12" REINFORCED CONCRETE PIPE	LF	500		
108	650014	P	18" REINFORCED CONCRETE PIPE	LF	640		
109	650026	P	36" REINFORCED CONCRETE PIPE	LF	66		
110	665025	P	24" CORRUGATED STEEL PIPE (.138" THICK)	LF	57		
111	665033	P	30" CORRUGATED STEEL PIPE (.138" THICK)	LF	6		
112	665038	P	36" CORRUGATED STEEL PIPE (.138" THICK)	LF	10		
113	665048	P	48" CORRUGATED STEEL PIPE (.138" THICK)	LF	150		
114	680905	P	8" PERFORATED PLASTIC PIPE UNDERDRAIN	LF	3,330		
115	680905A	P	8" PLASTIC PIPE UNDERDRAIN OUTLET	LF	150		
116	681107A	P	3" PVC PIPE	LF	280		
117	681132		GEOCOMPOSITE DRAIN	SY	165		
118	690118	P	18" CORRUGATED STEEL PIPE DOWNDRAIN (.109" THICK)	LF	480		
119	690125	P	24" CORRUGATED STEEL PIPE DOWNDRAIN (.138" THICK)	LF	73		
120	692001	P	ENTRANCE TAPER	EA	7		
121	692307	P	18" ANCHOR ASSEMBLY	EA	29		
122	702600A		TEE ENERGY DISSIPATOR	EA	2		
123	703460	P	24" WELDED STEEL PIPE CASING (BRIDGE)	LF	154		
124	703515	P	8" WELDED STEEL PIPE (.134" THICK)	LF	90		

U.S. 50 / SILVA VALLEY PARKWAY INTERCHANGE – PHASE 1
Contract No. PW 12-30647 / CIP No. 71328
Addendum No. 1

County of El Dorado
Proposal
Page P-8

ITEM NO.	ITEM	P-F	DESCRIPTION	UNIT	ESTIMATED QUANTITY	ITEM PRICE	TOTAL
125	705011		18" STEEL FLARED END SECTION	EA	10		
126	705015		24" STEEL FLARED END SECTION	EA	4		
127	705019		30" STEEL FLARED END SECTION	EA	1		
128	705031		48" STEEL FLARED END SECTION	EA	2		
129	705311		18" ALTERNATIVE FLARED END SECTION	EA	15		
130	705315		24" ALTERNATIVE FLARED END SECTION	EA	5		
131	705321		36" ALTERNATIVE FLARED END SECTION	EA	2		
132	707200		MANHOLE (SDMH)	EA	2		
133	721015	F	ROCK SLOPE PROTECTION (LIGHT, METHOD B)	CY	267		
134	721026	F	ROCK SLOPE PROTECTION (BACKING NO. 1, METHOD B)	CY	302		
135	721028	F	ROCK SLOPE PROTECTION (BACKING NO. 2, METHOD B)	CY	1,319		
136	721810		SLOPE PAVING (CONCRETE)	CY	37		
137	729011	P	ROCK SLOPE PROTECTION FABRIC (CLASS 8)	SY	9,250		
138	730010		MINOR CONCRETE (CURB)	LF	6,310		
139	730040		MINOR CONCRETE (GUTTER)	LF	140		
140	731504		MINOR CONCRETE (CURB AND GUTTER)	LF	3,400		
141	731521		MINOR CONCRETE (SIDEWALK)	CY	240		
142	731530		MINOR CONCRETE (TEXTURED PAVING)	CY	230		
143	731623		MINOR CONCRETE (CURB RAMP)	CY	4		
144	750001	P-F	MISCELLANEOUS IRON AND STEEL	LB	15,332		
145	750505	P-F	BRIDGE DECK DRAINAGE SYSTEM	LB	6,698		

ITEM NO.	ITEM	P-F	DESCRIPTION	UNIT	ESTIMATED QUANTITY	ITEM PRICE	TOTAL
146	800001	P	FENCE (TYPE BW, METAL POST)	LF	1,100		
147	800360	P	CHAIN LINK FENCE (TYPE CL-6)	LF	7,050		
148	801230	P	16' WIRE MESH GATE	EA	2		
149	801300	P	DUAL PIPE GATE	EA	1		
150	802620	P	16' CHAIN LINK GATE (TYPE CL-6)	EA	1		
151	810116		SURVEY MONUMENT (TYPE D)	EA	14		
152	820107		DELINEATOR (CLASS 1)	EA	167		
153	820110		HIGHWAY POST MARKER	EA	3		
154	820130		OBJECT MARKER	EA	30		
155	832003	P	METAL BEAM GUARD RAILING (WOOD POST)	LF	6,900		
156	832070		VEGETATION CONTROL (MINOR CONCRETE)	SY	3,810		
157	833077		PEDESTRIAN BARRICADE (TYPE I)	EA	2		
158	833077A		STREET BARRICADE	EA	2		
159	833090A	P-F	TUBULAR BICYCLE RAILING	LF	647		
160	839521	P-F	CABLE RAILING	LF	176		
161	839541	P	TRANSITION RAILING (TYPE WB)	EA	10		
162	839581		END ANCHOR ASSEMBLY (TYPE SFT)	EA	17		
163	839585		ALTERNATIVE FLARED TERMINAL SYSTEM	EA	24		
164	839700		CONCRETE BARRIER (TYPE 60F)	LF	150		
165	839701		CONCRETE BARRIER (TYPE 60)	LF	570		
166	839701A		CONCRETE BARRIER (TYPE 60 MOD)	LF	64		

ITEM NO.	ITEM	P-F	DESCRIPTION	UNIT	ESTIMATED QUANTITY	ITEM PRICE	TOTAL
167	839704A		CONCRETE BARRIER (TYPE 60D MOD)	LF	10		
168	839720	F	CONCRETE BARRIER (TYPE 732)	LF	225		
169	839727	F	CONCRETE BARRIER (TYPE 736 MOD)	LF	1,566		
170	839735A	F	CONCRETE BARRIER (TYPE 742 MOD)	LF	323		
171	840502		THERMOPLASTIC TRAFFIC STRIPE (ENHANCED WET NIGHT VISIBILITY)	LF	73,500		
172	840516		THERMOPLASTIC PAVEMENT MARKING (ENHANCED WET NIGHT VISIBILITY)	SF	4,980		
173	840656		PAINT TRAFFIC STRIPE (2-COAT)	LF	790		
174	850111	P	PAVEMENT MARKER (RETROREFLECTIVE)	EA	1,960		
175	860090		MAINTAINING EXISTING TMS ELEMENTS DURING CONSTRUCTION	LS	1		
176	860251	P	SIGNAL AND LIGHTING (LOCATION 1)	LS	1		
177	860252	P	SIGNAL AND LIGHTING (LOCATION 2)	LS	1		
178	860253	P	SIGNAL AND LIGHTING (LOCATION 3)	LS	1		
179	860460	P	LIGHTING AND SIGN ILLUMINATION	LS	1		
180	860799		BATTERY BACKUP SYSTEM	LS	1		
181	861100A		RAMP METERING SYSTEM AND TMS ELEMENTS	LS	1		
182	869001A		EMERGENCY VEHICLE PREEMPTION SYSTEM (LOCATIONS 1 THRU 3)	LS	1		
183	869050		GUARD POST	EA	4		
184	869050A		GUARD POST (REMOVABLE)	EA	1		
185	999990		MOBILIZATION	LS	1		

ITEM NO.	ITEM	P-F	DESCRIPTION	UNIT	ESTIMATED QUANTITY	ITEM PRICE	TOTAL
<u>EID UTILITY RELOCATION WORK ITEMS</u>							
186	150204B		ABANDON 12" AC WATER LINE	LF	1,030		
187	150204C		ABANDON 8" WATER LINE	LF	200		
188	152375A		RELOCATE PRESSURE REDUCING STATION	EA	1		
189	152375B		RELOCATE BLOW OFF VALVE	EA	1		
190	152375C		RELOCATE AIR RELEASE VALVE	EA	1		
191	208591A		BLOWOFF VALVE	EA	1		
192	510502A		MINOR CONCRETE (ENCASEMENT)	CY	11		
193	700001A		8" WATER LINE (CL-150)	LF	160		
194	700001B		12" WATER LINE (CL-150)	LF	1,030		
<u>EID UTILITY RELOCATION WORK ITEMS (REIMBURSABLE)</u>							
195	150204D		ABANDON 12" AC WATER LINE (EID)	LF	2,940		
196	150776A		REMOVE VALVE (EID)	EA	3		
197	150809A		REMOVE WATER LINE (EID)	LF	70		
198	151508A		RECONSTRUCT MANHOLE (EID)	EA	6		
199	152351		RELOCATE HYDRANT (EID)	EA	2		
200	152375D		RELOCATE AIR RELEASE VALVE (EID)	EA	1		
201	152375E		RELOCATE GATE VALVE (EID)	EA	1		
202	152375F		RELOCATE SAMPLING STATION (EID)	EA	1		
203	152451A		ADJUST WATER VALVE TO GRADE (EID)	EA	11		
204	152475A		ADJUST SSMH TO GRADE (EID)	EA	2		

ITEM NO.	ITEM	P-F	DESCRIPTION	UNIT	ESTIMATED QUANTITY	ITEM PRICE	TOTAL
205	208591B		BLOWOFF VALVE (EID)	EA	1		
206	208591C		INSTALL BLIND FLANGE (EID)	EA	1		
207	700001C		12" WATER LINE (DR-14) (EID)	LF	590		
TOTAL BID:							

F - Final Pay Quantity

P - Eligible for Partial Payment

LS - Lump Sum

NOTICE: Bidders failure to execute the questionnaires and statements contained in this proposal as required by applicable laws and regulations, or the determinations by County of El Dorado based upon those questionnaires and statements, may prohibit award of the subject Contract to the bidder.)

SUBCONTRACTOR LIST

The Bidder must list the name, address, and license number, of each subcontractor to whom the Bidder proposes to subcontract portions of the work, as required by the provisions in section 2-1.33C. The Bidder must also list the work portion to be performed by each subcontractor by listing the bid item number, bid item description, and portion of the work to be performed by the subcontractor in the form of a percentage calculated by dividing the work to be performed by the subcontractor by the respective bid item amount(s) (not by the total bid price).

Name	Location of Business	License No.	Bid Item Number and Bid Item Description	Percentage of Each Bid Item Subcontracted

Public Contract Code Section 10285.1 Statement

In conformance with Public Contract Code Section 10285.1 (Chapter 376, Stats. 1985), the Bidder hereby declares under penalty of perjury under the laws of the State of California that the Bidder has _____, has not _____ been convicted within the preceding three years of any offenses referred to in that section, including any charge of fraud, bribery, collusion, conspiracy, or any other act in violation of any state or Federal antitrust law in connection with the bidding upon, award of, or performance of, any public works contract, as defined in Public Contract Code Section 1101, with any public entity, as defined in Public Contract Code Section 1100, including the Regents of the University of California or the Trustees of the California State University. The term "Bidder" is understood to include any partner, member, officer, director, responsible managing officer, or responsible managing employee thereof, as referred to in Section 10285.1.

Note: **The Bidder must place a check mark after "has" or "has not" in one of the blank spaces provided. The above Statement is part of the Proposal. Signing this Proposal on the signature portion thereof shall also constitute signature of this Statement. Bidders are cautioned that making a false certification may subject the certifier to criminal prosecution.**

Public Contract Code Section 10162 Questionnaire

In conformance with Public Contract Code Section 10162, the Bidder shall complete, under penalty of perjury, the following questionnaire:

Has the Bidder, any officer of the Bidder, or any employee of the Bidder who has a proprietary interest in the Bidder, ever been disqualified, removed, or otherwise prevented from bidding on, or completing a federal, state, or local government project because of a violation of law or a safety regulation?

Yes _____ No _____

If the answer is yes, explain the circumstances in the following space.

Public Contract Code Section 10232 Statement

In conformance with Public Contract Code Section 10232, the Bidder, hereby states under penalty of perjury under the laws of the State of California, that no more than one final unappealable finding of contempt of court by a Federal Court has been issued against the Bidder within the immediately preceding two year period because of the Bidder's failure to comply with an order of a Federal Court which orders the Bidder to comply with an order of the National Labor Relations Board.

Note: The above Statement and Questionnaire are part of the Proposal. Signing this Proposal on the signature portion thereof shall also constitute signature of this Statement and Questionnaire.

Bidders are cautioned that making a false certification may subject the certifier to criminal prosecution.

NONCOLLUSION AFFIDAVIT

(Title 23 United States Code Section 112 and
Public Contract Code Section 7106)

In conformance with Title 23 United States Code Section 112 and Public Contract Code 7106 the Bidder declares that the bid is not made in the interest of, or on behalf of, any undisclosed person, partnership, company, association, organization, or corporation; that the bid is genuine and not collusive or sham; that the Bidder has not directly or indirectly induced or solicited any other bidder to put in a false or sham bid, and has not directly or indirectly colluded, conspired, connived, or agreed with any bidder or anyone else to put in a sham bid, or that anyone shall refrain from bidding; that the Bidder has not in any manner, directly or indirectly, sought by agreement, communication, or conference with anyone to fix the bid price of the bidder or any other bidder, or to fix any overhead, profit, or cost element of the bid price, or of that of any other bidder, or to secure any advantage against the public body awarding the Contract of anyone interested in the proposed Contract; that all statements contained in the bid are true; and, further, that the Bidder has not, directly or indirectly, submitted his or her bid price or any breakdown thereof, or the contents thereof, or divulged information or data relative thereto, or paid, and will not pay, any fee to any corporation, partnership, company association, organization, bid depository, or to any member or agent thereof to effectuate a collusive or sham bid.

NOTE:

The above Noncollusion Affidavit is part of the Proposal. Signing this Proposal on the signature portion thereof shall also constitute signature of this Noncollusion Affidavit.

Bidders are cautioned that making a false certification may subject the certifier to criminal prosecution.

IRAN CONTRACTING ACT CERTIFICATION

(Public Contract Code Section 2200 *et seq.*)

As required by California Public Contract Code Section 2204, you certify subject to penalty for perjury that the option checked below relating to your status in regard to the Iran Contracting Act of 2010 (Public Contract Code Section 2200 *et seq.*) is true and correct:

You are not:

(i) identified on the current list of persons and entities engaging in investment activities in Iran prepared by the California Department of General Services in accordance with subdivision (b) of Public Contract Code Section 2203; or

(ii) a financial institution that extends, for 45 days or more, credit in the amount of \$20,000,000 or more to any other person or entity identified on the current list of persons and entities engaging in investment activities in Iran prepared by the California Department of General Services in accordance with subdivision (b) of Public Contract Code Section 2203, if that person or entity uses or will use the credit to provide goods or services in the energy sector in Iran.

The Authority has exempted you from the requirements of the Iran Contracting Act of 2010 after making a public finding that, absent the exemption, the Authority will be unable to obtain the goods and/or services to be provided pursuant to the contract.

The amount of the contract payable to you for the work does not exceed \$1,000,000.

Signed _____

Titled _____

Firm _____

Date _____

Note: In accordance with Public Contract Code Section 2205, false certification of this form shall be reported to the California Attorney General and may result in civil penalties equal to the greater of \$250,000 or twice the contract amount, termination of the contract and/or ineligibility to bid on public contracts for three years.

**DEBARMENT, SUSPENSION, INELIGIBILITY, AND VOLUNTARY EXCLUSION CERTIFICATION, UNITED STATES
DEPARTMENT OF TRANSPORTATION(USDOT) 2 CODE OF FEDERAL REGULATIONS (CFR) 1200 FEDERAL
AGENCY REGULATIONS FOR GRANTS AND AGREEMENTS AND EXECUTIVE ORDER 12549**

The Bidder, under penalty of perjury, certifies that, except as noted below, he/she or any other person associated therewith in the capacity of owner, partner, director, officer, or manager:

- is not currently under suspension, debarment, voluntary exclusion, or determination of ineligibility by any Federal agency;
- has not been suspended, debarred, voluntarily excluded or determined ineligible by any Federal agency within the past 3 years;
- does not have a proposed debarment pending; and
- has not been indicted, convicted, or had a civil judgment rendered against it by a court of competent jurisdiction in any matter involving fraud or official misconduct within the past 3 years.

If there are any exceptions to this certification, insert the exceptions in the following space.

Exceptions will not necessarily result in denial of award, but will be considered in determining Bidder responsibility. For any exception noted above, indicate below to whom it applies, initiating agency, and dates of action.

Bidder further agrees by submitting this Proposal that it will include this clause without modification in all lower tier transactions, solicitations, proposals, contracts, and subcontracts. Where any lower tier participant is unable to certify to this statement, it shall attach an explanation to its proposal to the prime contractor.

Notes: Providing false information may result in criminal prosecution or administrative sanctions.

The above certification is part of the Proposal. Signing this Proposal on the signature portion thereof shall also constitute signature of this Certification.

CERTIFICATION OF BIDDER'S PRECAST BRIDGE MANUFACTURER'S QUALIFICATIONS

Bidder certifies that _____

(insert name of precast bridge manufacturer selected by Bidder)

meets the following requirements:

Check one or both of the following boxes as applicable:

Prior to and during production of the elements of the proposed bridge system the selected manufacturer is/will be certified by:

The Precast/Prestressed Concrete Institute Plant Certification Program

The National Precast Concrete Association's Plant Certification Program

AND

Has been in the business of producing precast concrete products similar to those specified for a minimum of 3 years. The selected manufacturer maintains a permanent quality control department or retains an independent testing agency on a continuing basis. The independent testing agency will issue a report, certified by a licensed engineer, detailing the ability of the manufacturer to produce quality products consistent with industry standards.

NOTE: The above Certification is part of the Proposal. Signing this Proposal on the signature portion thereof shall also constitute signature of this Certification.

Bidders are cautioned that making a false certification may result in the Bidder's bid being deemed non-responsive.

OPT OUT OF PAYMENT ADJUSTMENTS FOR PRICE INDEX FLUCTUATIONS

You may opt out of the payment adjustments for price index fluctuations as specified in "Payment Adjustments for Price Index Fluctuations" of the special provisions. If you elect to opt out of the provisions of this specification, complete this form and submit it with your bid.

Bidder Name: _____

Contract No. PW 12-30647

I opt out of the payment adjustments for price index fluctuations.

Date: _____

Signature: _____

Accompanying this proposal is _____

(NOTICE: INSERT THE WORDS "CASH(\$___),"CASHIER'S CHECK," "CERTIFIED CHECK," OR "BIDDERS BOND," AS THE CASE MAY BE)

in amount equal to at least ten percent of the total of the bid.

The names of all persons interested in the forgoing Proposal as principals are as follows:

IMPORTANT NOTICE: If the Bidder or other interested person is a corporation, state legal name of corporation and place of incorporation, also names of the president, secretary, treasurer, and executive officer thereof; if a partnership, state name of partnership, also names of all individual partners; if Bidder or other interested person is an individual, state first and last names in full.

Licensed in accordance with an act providing for the registration of Contractors,

License No. _____ Classification(s) _____

(A Copy of the afore-referenced license must be attached hereto.)

ADDENDA: This Proposal is submitted with respect to the changes to the Contract included in addenda number (s)

(Fill in addenda numbers if addenda have been received and insert, in this Proposal, any Proposal Pay Items and Bid Price Schedules that were received as part of the addenda)

By my signature on this Proposal I certify, under penalty of perjury under the laws of the State of California, that the foregoing questionnaire and statements of Public Contract Code Sections 10162, 10232, and 10285.1 are true and correct and that the Bidder has complied with the requirements of Sections 4104 of the Subletting and Subcontracting Fair Practices Act and of Section 8103 of the Fair Employment and Housing Commission Regulations (Chapter 5 of Division 4 of Title 2 of the California Code of Regulations). By my signature on this Proposal I further certify, under penalty of perjury under the laws of the State of California and the United States of America, that the Noncollusion Affidavit required by Title 23 United States Code, Section 112 and Public Contract Code Section 7106; Iran Contracting Act Certification; the Debarment Suspension, Ineligibility and Voluntary Exclusion Certification; the Fair Employment Practice Addendum, the Opt Out of Payment Adjustments for Price Index Fluctuations, if elected, and Certification Of Bidder's Pre-Fabricated Bridge Manufacturer's Qualifications are true and correct.

The person or persons executing this Proposal on behalf of a corporation or partnership shall be prepared to demonstrate by resolution, article, or otherwise, that such person is or that such persons are appropriately authorized to act in these regards for such corporation or partnership. Such authority shall be demonstrated to the satisfaction of the County of El Dorado.

If the signature is by an agent other than an officer of a corporation or a member of a partnership, a power of attorney authorizing said act by the agent on behalf of his principal shall be submitted with the bid forms; otherwise, the bid may be disregarded as irregular and unauthorized.

The Bidder's execution on the signature portion of this Proposal shall constitute an endorsement and execution of those affidavits, declarations and certifications which are part of this Proposal.

Executed this _____ day of _____, 20____

at _____ County, State of _____

Date: _____



Name and Title of Bidder _____

Name of Firm _____

END OF PROPOSAL

U.S. 50 / SILVA VALLEY PARKWAY INTERCHANGE – PHASE 1
Contract No. PW 12-30647 / CIP No. 71328
Addendum No. 1

County of El Dorado
Proposal
Page P-22

FILE NAME: svp_TH1-1 THRU TH1-6 PLOT DATE: Aug 19, 2013-12:37:54pm CAD USER: jeden

STATE OF CALIFORNIA - DEPARTMENT OF TRANSPORTATION	CONSULTANT FUNCTIONAL SUPERVISOR	REVISOR	DATE
JEFF NETTLETON	ROBERT A. HIMES	JEFF NETTLETON	
DEREK W. MINNEMA	CHECKED BY	DEREK W. MINNEMA	
	CALCULATED/DESIGNED BY		

Dist	COUNTY	ROUTE	POST MILES TOTAL PROJECT	SHEET No.	TOTAL SHEETS
03	ED	50	1.02/R2.40	179	371

Estaff
 REGISTERED CIVIL ENGINEER DATE 1/4/13
 JANUARY 28, 2013
 PLANS APPROVAL DATE

THE STATE OF CALIFORNIA OR ITS OFFICERS OR AGENTS SHALL NOT BE RESPONSIBLE FOR THE ACCURACY OR COMPLETENESS OF SCANNED OR ELECTRONIC COPIES OF THIS PLAN SHEET.

MARK THOMAS & CO., INC.
 7300 FOLSOM BLVD STE 203
 SACRAMENTO, CA 95826

COUNTY OF EL DORADO
 DEPT. OF TRANSPORTATION
 2850 FAIRLANE COURT
 PLACERVILLE, CA 95667

REGISTERED PROFESSIONAL ENGINEER
ROBERT A. HIMES
 No. 45787
 Exp 12/31/14
 CIVIL
 STATE OF CALIFORNIA

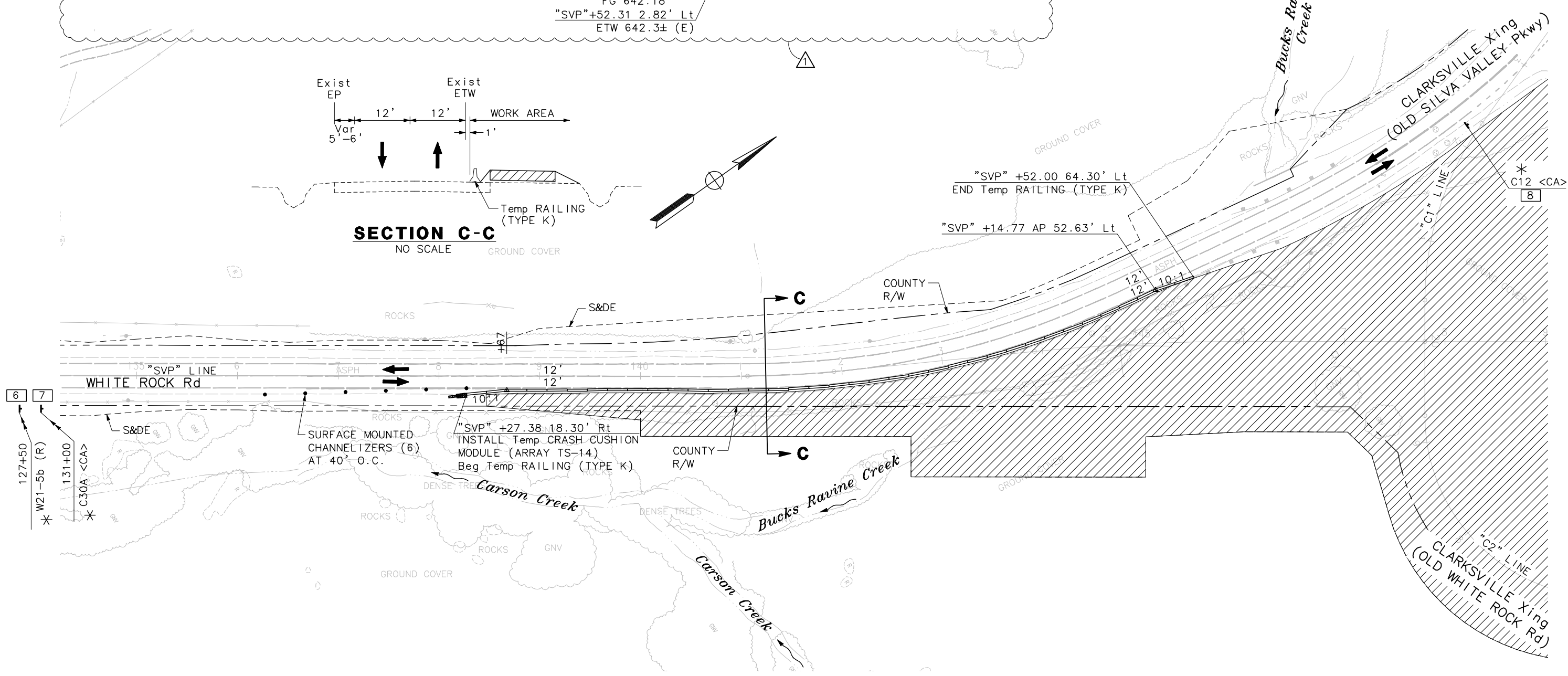
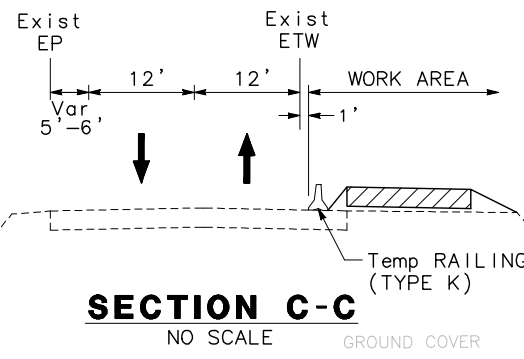
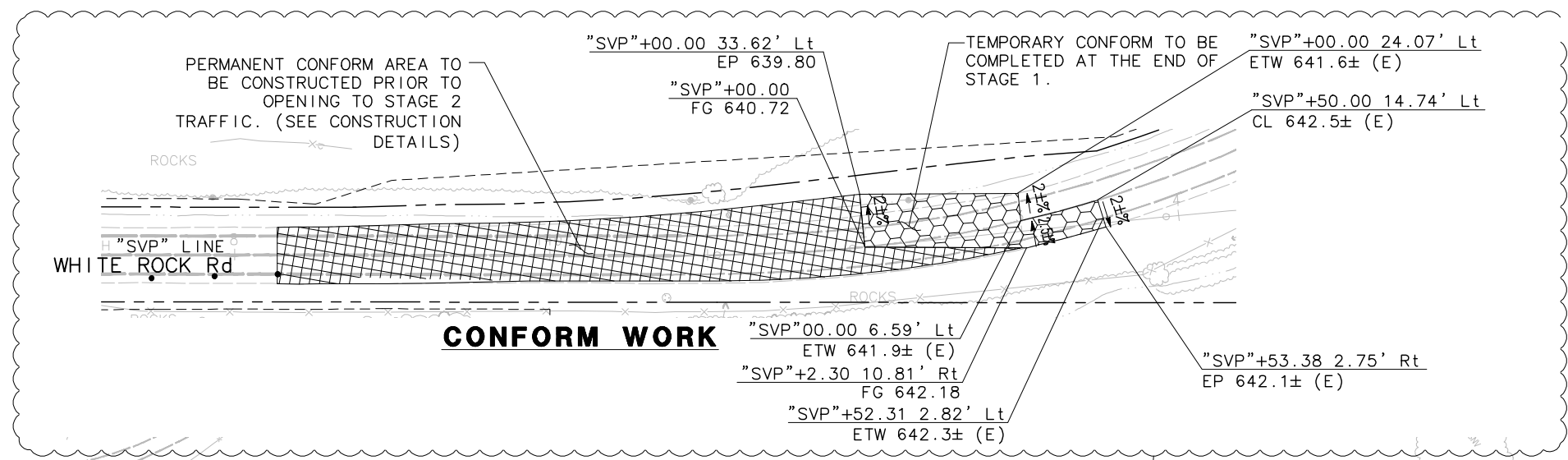

1	08-19-2013	ADDED CONFORM DETAIL	JMN	DWM
MARK	DATE	DESCRIPTIONS	BY	CH'D
REVISIONS				

TRAFFIC HANDLING
STAGE 1
 SCALE: 1"=50'
TH1-5

THIS PLAN ACCURATE FOR TRAFFIC HANDLING WORK ONLY

FOR NOTES, LEGEND AND ABBREVIATIONS, SEE TH1-1

FILE NAME: svp_TH1-1 THRU TH1-6 PLOT DATE: Aug 19, 2013-12:38:06pm CAD USER: jedn

STATE OF CALIFORNIA - DEPARTMENT OF TRANSPORTATION	CONSULTANT FUNCTIONAL SUPERVISOR	REVISIONS
JEFF NETTLETON	ROBERT A. HIMES	REVISIONS
DEREK W. MINNEMA	CHECKED BY	DATE REVISED

Dist	COUNTY	ROUTE	POST MILES TOTAL PROJECT	SHEET No.	TOTAL SHEETS
03	ED	50	1.02/R2.40	180	371

REGISTERED CIVIL ENGINEER DATE 1/4/13
 ROBERT A. HIMES
 No. 45787
 Exp 12/31/14
 CIVIL
 STATE OF CALIFORNIA

JANUARY 28, 2013
 PLANS APPROVAL DATE

THE STATE OF CALIFORNIA OR ITS OFFICERS OR AGENTS SHALL NOT BE RESPONSIBLE FOR THE ACCURACY OR COMPLETENESS OF SCANNED OR ELECTRONIC COPIES OF THIS PLAN SHEET.

MARK THOMAS & CO., INC.
 7300 FOLSOM BLVD STE 203
 SACRAMENTO, CA 95826

COUNTY OF EL DORADO
 DEPT. OF TRANSPORTATION
 2850 FAIRLANE COURT
 PLACERVILLE, CA 95667

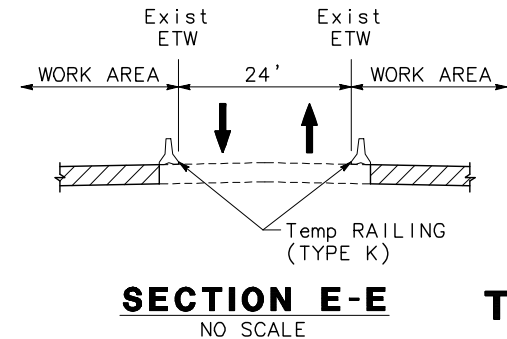
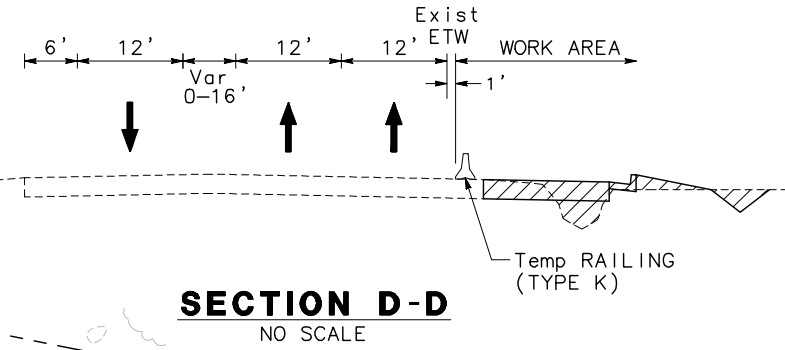
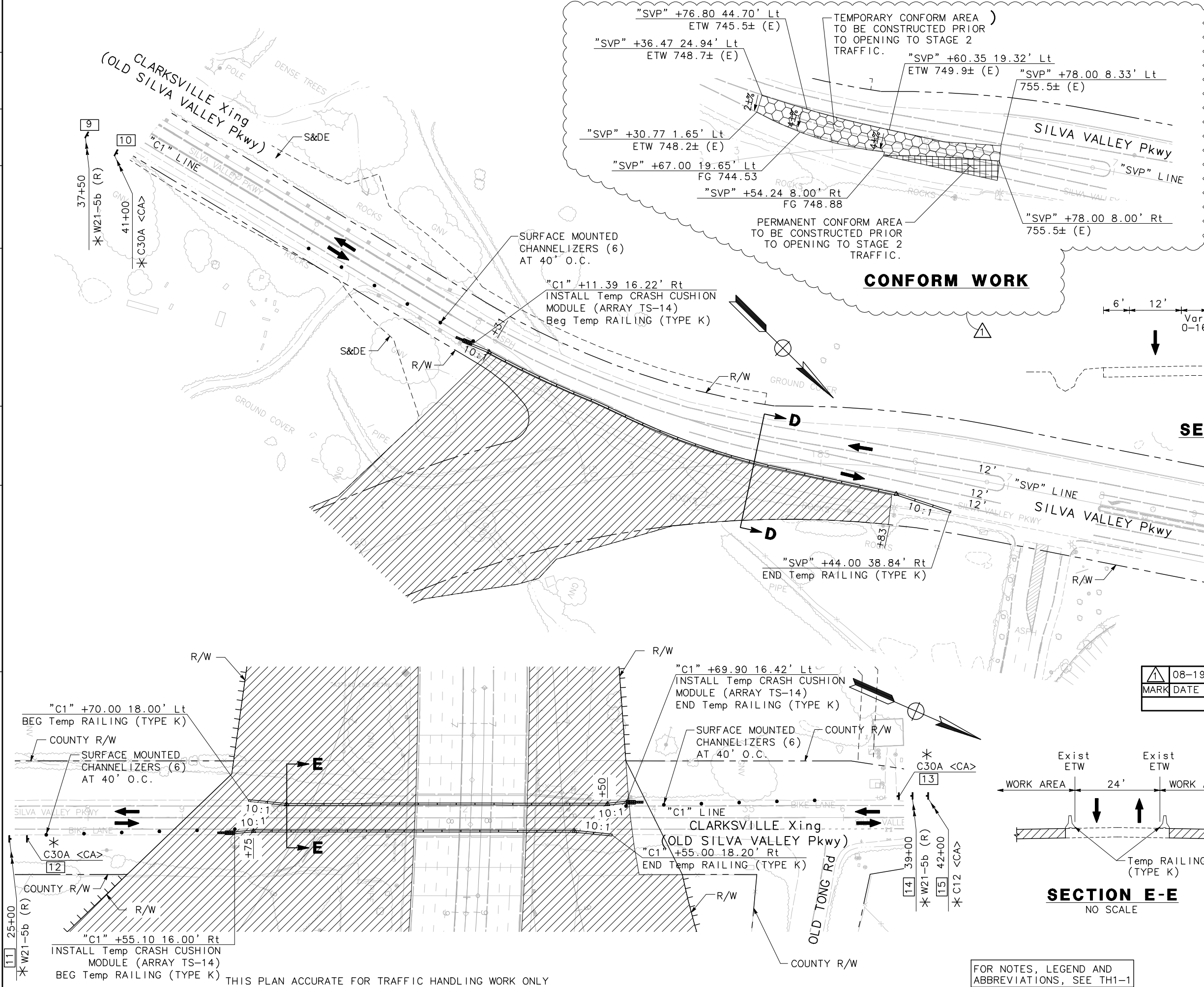

MARK	DATE	DESCRIPTIONS	BY	CH'D
▲	08-19-2013	ADDED CONFORM DETAIL	JMN	DWM
REVISIONS				

TRAFFIC HANDLING STAGE 1
SCALE: 1"=50'

TH1-6

FOR NOTES, LEGEND AND ABBREVIATIONS, SEE TH1-1

COUNTY CIP: 71328 EA: 03-1E290 DATE PLOTTED => 8/19/2013 TIME PLOTTED => 12:38 PM

Replace "Reserved" in section 86-2.17 with:

86-2.17 OVERHEIGHT VEHICLE DETECTION AND WARNING SYSTEM

86-2.17A General

86-2.17A(1) Summary

This work includes installing the over height vehicle detection and warning system (OVDS). Comply with Section 86, "Electrical Systems," Transportation Electrical Equipment Specifications (TEES), and California Manual on Uniform Traffic Control Devices (CAMUTCD).

86-2.17B Materials

86-2.17B(1) General

The over height vehicle detection and warning system (OVDS) consists of one or more the following equipment, specified elsewhere in these special provisions, as described in this Section and as shown:

1. Dual beam, direction discerning systems.
2. Loop/sensor interface units.
3. Flasher/alarm control box
4. Directional Bell with Parabolic Shield.
5. Electrical siren.
6. Flashing beacon
7. EMS signs and control units.
8. Emergency backup generator
9. Automatic Transfer Switch (ATS)
10. Mounting brackets and axis mounts

The OVDS system must be manufactured by one of the following manufacturers:

1. IRD – International Road Dynamic Inc.
702 43rd Street East
Saskatoon, SK.
Canada S7K 3T9
Telephone: 302-653-6600
IRD U.S. Corporation telephone 1-877-444-4473
2. IDT – Integrated Design Techniques Limited
Endurance House
Seventh Avenue
Team Valley
Tyne & Wear
NE11 0EF
United Kingdom
Telephone: +44(0)191 491 0800
3. Coeval
Bush House
Edinburgh Technopole, Edinburgh
EH26 0BB
Telephone: +44(0)131 445 8686

86-2.17B(2) Dual Beam, Direction Discerning Systems

The dual beam, direction discerning systems must consist of red infrared dual beam array and must conform to the following requirements:

Input Power	115 VAC +/- 10%.
Alarm Outputs	Two dry relay contact closures. Form C, contacts rated 115VAC 10A and protected by 8A
Fault Output	Dry relay contact closure. Form C, contacts rated 115VAC 10A and protected by 8A circuit
Alarm Time	Adjustable from 1 to 30 seconds.
Electronic	Sensors are NEMA 6P enclosure rated. Printed circuit board for years of reliable operation.
Effect of Ambient Light	10,000 Foot Candles for Red Detector. Very high noise immunity for IR detector.
Maximum Range	700 feet. Suggested maximum range of 200 feet to allow for bad weather and lens contamination.
Direction Selection	Selection switch. No tools or adjusted required.
Alignment	Two Green LED and GO-NOGO meter provided for alignment. No special tools required.
Reaction Speed	1 mph to 75 mph for a 2.5 inch diameter object 1 inch above the height of detection.
Counter	Records the number of activations.
Temperature Range	-40° F to +135° F.
Environmental Control	Internal thermostat controls air flow which reduces moisture and maintains internal temperature during cold weather.
Housings	External housing must be heavy ALMAG casting and sheet aluminum (not less than 1/8 inch thickness) to minimize vandalism and provide for rigid mounting. The pole cap serves as the mounting bracket and sighting base when our poles are used.
Dimensions	Transmitter / Receiver – 16 1/2" x 12 1/2" x 8 3/4"
Weight	45 lbs or less.

86-2.17B(3) Loop Detector Interface

Loop detector interface must not be false-trigger by non-vehicular. A loop detector (or detectors) must be installed in the roadway so that an over height alarm is issued only when a vehicle is present. The interface is designed to accept a relay contact opening from a loop detector (or detectors) and a relay contact closure. The loop detector interface unit includes a "Loop Hold" adjustment that allows for slower moving vehicles to be detected. The loop detector interface must conform to the following requirements:

INPUT POWER	115 VAC +/- 10% Hz.
OUTPUT	Two Form C dry relay contacts rated at 10A, protected by 8A fuses.
ALARM TIME	An alarm time adjustment is incorporated that allows a double-pole-throw relay to be energized from 1 to 30 seconds on receiving a valid alarm. This feature enables the OVDS alarm time to be set for a short time (1 – 2 seconds), which in turn, allows the loop detector interface control over alarm time.
ELECTRONICS	Heavy duty printed circuit board, terminal strips with screw connections.
TEMPERATURE RANGE	-40° to +135°F.
HOUSING	All electronics are enclosed in PVC NEMA rated cabinet. Cord grips/strain relief connectors are included for cable access. The enclosure need not be mounted near either the loop relay(s) or OVDS but do not have more than 500 feet of separation due to the possibility of noise pickup in the cabling. Use shielded cable as necessary.
WEIGHT	20 lbs or less.

86-2.17B(4) Flasher/Alarm Control Box

Flasher/Alarm Control Box must have the input power 117 VAC, +/-10% and 50/60Hz. Flasher/Alarm control box must be activated by OVDS. Activation time set by Alarm Time Control in OVDS (1 – 30 seconds). The Contractor must provide one independent set of Form C, dry relay contacts, rated at 10A protected by an 8A fuse, to activate warning devices. Also, the Contractor must provide another independent set of Form C, dry relay contacts, rated at 10A protected by an 8A fuse that provides 117VAC to activate 117VAC LED traffic style heads. Flasher/Alarm control box must be operated between temperature -40°F and +135°F. Enclosures must be steel. Standard enclosures must be approximately 12"W x 14"L x 6"D. The weight must be 20 pounds or less.

86-2.17B(5) Direction Bell with Parabolic Reflecting Shield

must have input power 120 VAC, 50/60 Hz. The Bells must be 101 db at 10 feet and 76 db at 100 feet directed by parabolic shield. Shield diameter must be 38 inches. Provide adjustable mounting bracket as required.

86-2.17B(6) Electronic Siren

Input power for electronic siren must be 120 VAC, 210 mA, 25.2 watts. The db output of siren must be 111 db at 10 feet and 121 db at 3 feet. The tones must be Wail, Yelp, and Horn. The siren must be operated between temperature -31°F and 161°F. The enclosure must be Type 3R when used with weatherproof box.

86-2.17B(7) Flashing Beacons

Light Emitting Diode LED must be used for the flashing beacon.

86-2.17B(8) Emergency Backup Generator

The back-up unit must include an enclosure cabinet, a diesel generator, a transfer panel, a fuel tank, and an external flashing warning light which is activated during generator operation.

The emergency standby generator must set standby rated 10 kw, 120/240 volts, single phase, 60 Hz, 1800 RPM with all standard accessories and the following materials:

- A. Unit mounted sound attenuated housing with louvered air intake and lockable service doors.
- B. Unit mounted critical grade exhaust silencer, complete with stainless steel flexible exhaust connection and rain cap.
- C. Unit mounted jacket water heater rated at 500 watts, 120/240 volts, with adjustable thermostat.
- D. Unit mounted digital control panel, vibration mounted, oil and dust-tight, with gasket door to include all of the following standard features:

1. Standard generator controls to include:
 - a. Digital Ammeter
 - b. Digital voltmeter
 - c. Lube oil pressure
 - d. Coolant temperature gauge
 - e. Digital Frequency meter and Tachometer
 - f. Ammeter/voltmeter phase selector switch
 - g. Voltage adjust rheostat
2. Standard engine controls to include:
 - a. Automatic/Manual start stop control
 - b. Control switch for Run/Stop/Auto
 - c. 3 Attempt Start timer
 - d. Cool down timer
 - e. Emergency stop (red mushroom button)
3. Safety shutdown protection and LED indicators to include:
 - a. Low oil pressure
 - b. Failure to start
 - c. High coolant temperature
 - d. Overspeed
4. Alarms to include:
 - a. Approaching low oil pressure
 - b. Approaching high engine temperature
 - c. Low battery voltage
 - d. Battery charger failure
 - e. Low fuel and high level fuel
 - f. Control switch not in auto mode
- E. Unit mounted 100 Amp, 3 pole main line circuit breaker, 80% rated in a NEC sized enclosure suitable for connection from the bottom.
- F. Unit mounted UL labeled sub base fuel tank with:
 - a. Fuel level gauge
 - b. Low and high fuel level contacts
 - c. Rupture basin
 - d. Leak detector in rupture basin
- G. Unit mounted UL2200 Labeling.
- H. Unit mounted Float/equalize type Battery Charger.
- I. Unit mounted starting battery is 12-volt, mounted in integral racks within the generator set base rails.
- J. Unit mounted Vibration Isolators.
- K. The operation cycle duration must be 20 hours minimum with a full tank of fuel.

86-2.17B(9) Waterproof Generator Enclosure

The cabinet enclosure must be steel. The cabinet must be weather-tight and must include lockable doors. Cable entry must be provided on the bottom of the unit (stub-up). The cabinet must be bolted to the foundation inside the cabinet.

The enclosure must have the following standard features:

- A. Highly corrosion resistant construction
 1. Black zinc die cast hinges tested and proven to withstand extreme conditions of corrosion
 2. Zinc plated or stainless steel fasteners
 3. Body made from steel components treated with polyester powder coating
- B. Excellent Access
 1. Large cable entry area for installation ease

2. Doors located convenient to controls and service areas
 3. Double doors on both sides
 4. Vertically hinged doors allow 180 degree opening rotation
 5. "Life-off" doors, removable with 45 degree opening in confined locations.
 6. Lube oil and coolant drains piped to exterior of enclosure and end with drain valves
 7. Hinged radiator fill cover
- C. Security and Safety
1. Lockable access doors with standard key utilization
 2. Cooling fan and battery charging alternator fully guarded
 3. Exhaust silencing system totally enclosed for operator safety
 4. Roof outlet exhaust with sealed roof aperture and rain cap
 5. Stub-up cover sheets for "rodent proofing"
- D. Provide one (1) Copy of the detailed operation and maintenance manual. The manuals must be kept to the inside of front door of the enclosure.

86-2.17B(10) Automatic Transfer Switch (ATS)

The Automatic Transfer Switch (ATS) must be installed in the NEMA Type 3R cabinet and mounted to the generator enclosure. The ATS must be installed in accordance to the manufacturer's instructions and all applicable codes. The ATS must be prototype tested, factory built, production tested and site tested. A transfer switch with the number of poles, voltage and current ratings shown and specified in this Section must be provided.

The automatic transfer switch must conform to the requirements of:

1. UL 1008: Underwriters Laboratories standard for automatic transfer switches
2. CSA: C22.2 No. 178 certified
3. IEC: 947-6-1 certified at 120/240 VAC
4. NFPA 70: National Electrical Code including use in emergency and standby systems in accordance with Articles 517, 700, 701, 702
5. NFPA 99: Essential electrical systems for health care facilities
6. NFPA 101: Life safety code
7. NFPA 110: Standard for emergency and standby power systems
8. IEEE 241: I.E.E.E. recommended practice for electrical power systems in commercial buildings
9. IEEE 446: I.E.E.E. recommended practice for emergency and standby power systems
10. NEMA ICS10: AC automatic transfer switch equipment
11. UL 50/508: Enclosures
12. ICS 6: Enclosures
13. ANSI C33.76: Enclosures
14. NEMA 250: Enclosures
15. IEEE 472: (ANSI C37.90A): Ringing wave immunity
16. EN55022 (CISPR11): Conducted and radiated emissions (Exceeds EN55011 & MILSTD 461 Class 3)
17. EN61000-4-2: (Level 4): ESD immunity test Class B:
18. EN61000-4-3: (ENV50140): Radiated RF, electromagnetic field immunity
19. EN61000-4-4: Electrical fast transient/burst immunity test
20. EN61000-4-5: IEEE C62.41: Surge immunity test (1.2 x 50 μ s, 5 & 8 kV)
21. EN61000-4-6: (ENV50141): Conducted immunity test
22. EN61000-4-11: Voltage dips and interruption immunity

86-2.17B Construction

The automatic transfer switch must be of double throw construction operated by a reliable solenoid driven mechanism. There must be a direct mechanical coupling to facilitate transfer in 6 cycles or less.

The normal and emergency contacts must be mechanically interlocked such that failure of any coil or disarrangement of any part will not allow a neutral position.

For switches installed in systems having ground fault protective devices, and/or wired so as to be designated a separately derived system by the NEC, a 4th pole must be provided. This additional pole must isolate the normal and emergency neutrals. The neutral pole must have the same withstand and operational ratings as the other poles and must be arranged to break last and make first to minimize neutral switching transients. Add-on or accessory poles that are not of identical construction and withstand capability will not be considered.

The contact structure must consist of a main current carrying contact, which is a silver alloy with a minimum of 50% silver content. The current carrying contacts must be protected by silver tungsten arcing contacts on all sizes above 400 Amps.

The transfer switch manufacturer must submit test data for each size switch, showing it can withstand fault currents of the magnitude and the duration necessary to maintain the system integrity. Minimum UL listed withstand and close into fault ratings must be as follows:

Size (Amps)	Coordinated Breaker	Current Limiting Fuse
40 - 225	30,000	200,000
260	35,000	200,000
400 – 600	50,000	200,000
800	65,000	200,000
1000 - 1200	85,000	200,000
1600 - 3000	100,000	200,000

A dielectric test at the conclusion of the withstand and closing tests must be performed.

The automatic transfer switch manufacturer must certify enough arc interrupting capabilities for 50 cycles of operation between a normal and emergency source. This certification is to ensure that there will be no current flow between the two isolated sources during switching.

1. All relays must be continuous duty industrial type with wiping contacts. Coils, relays, timers and accessories must be readily front accessible. The control panel and power section must be interconnected with a harness and keyed disconnect plugs for maintenance.
2. Main and arcing contacts must be visible without major disassembly to facilitate inspection and maintenance.
3. A manual handle must be provided for maintenance purposes with the switch de-energized. An operator disconnect switch must be provided to defeat automatic operation during maintenance, inspection or manual operation.
4. Switches composed of molded case breakers, lighting contactors or components thereof will not be acceptable.
5. The current rating must be a continuous rating when the switch is installed in an enclosure, and must conform to NEMA temperature rise standards.
6. The unit must be rated based on all classes of loads, i.e., resistive, tungsten, ballast and inductive loads. Switches rated 400 amperes or less must be UL listed for 100% tungsten lamp load.

7. Temperature rise tests under UL 1008 must be conducted after the overload and endurance tests to confirm the ability of the units to carry their rated currents within the allowable temperature limits.

86-2.17C(1) Control

The control panel must be opto-isolated from electrical noise and provided with the following Inherent control functions and capabilities:

1. Easy-to-view LCD display with long lasting LED indicators.
2. Control panel must display voltage and frequency of both sources.
3. The user must be able to view the last 16 recorded events.
4. Capability for external communication and network interface.
5. Adjustments to all settings must be made from the front of the panel without opening the door.

The transfer switch must be equipped with a microprocessor based control panel. The control panel must perform the operational and display functions of the transfer switch. The display functions of the control panel must include ATS position, source availability, sequence indication and diagnostics.

The display must be accessible without opening the enclosure door.

The control panel must be provided with a simple user interface for transfer switch monitoring, control and field changeable functions and settings.

Touch pad test switch with Fast Test/Load/No Load selection capability to simulate a normal source failure.

86-2.17C(2) Sequence of Operation

When the voltage of any phase of the normal source is reduced to 80% of nominal voltage, for a period of 0-10 seconds (programmable) a pilot contact must close to initiate starting of the engine generator.

The ATS must incorporate adjustable under voltage and under frequency sensing on the emergency source.

When the emergency source has reached a voltage value of 90% of nominal and achieved frequency within 95% of the rated value, the load must be transferred to the emergency source after a programmable time delay.

When the normal source has been restored to not less than 90% of rated voltage on all phases, the load must be retransferred to the normal source after a time delay of 0 to 60 minutes (programmable). The generator must run unloaded for 5 minutes (programmable) and then automatically shut down. The generator must be ready for automatic operation on the next failure of the normal source.

If the engine generator should fail while carrying the load, retransfer to the normal source must be made instantaneously on restoration of proper voltage (90%) on the normal source.

86-2.17C(3) Standard Accessories

Adjustable time delay to override momentary normal source failure before engine start. Field programmable 0-10 seconds factory set at 3 seconds.

Adjustable time delay on retransfer to normal source, programmable 0-60 minutes factory set at 30 minutes. If the emergency source fails during the retransfer time delay, the transfer switch controls must automatically bypass the time delay and immediately retransfer to the normal position.

A time delay on transfer to emergency, programmable 0-5 seconds, factory set at 1 second.

An in-phase monitor must be provided. The monitor must compare the phase angle difference between the normal and emergency sources and be programmed to anticipate the zero crossing point to minimize switching transients.

An exerciser timer with momentary test pushbutton must be incorporated within the microprocessor and must be capable of starting the engine generator set and transferring the load (when selected) for exercise purposes on a daily, weekly or monthly basis. The exerciser must contain a battery for memory retention during an outage.

Provide a momentary pushbutton to bypass the time delays on transfer and retransfer and programmable commit/no commit control logic.

The controller must accept a remote peak shave or test input to signal the transfer switch to the emergency position.

A set of customer contacts must be provided to indicate both emergency and normal source position.

The following additional accessories must be included:

1. Heater and Thermostat (HT) – Recommended for NEMA 3R applications.
2. Elevator pre-signal (T3/W3) – Contact Opens 0-60 seconds before transfer in either direction, re-closes after transfer.
3. Universal Motor Load Disconnect (UMD) - Auxiliary contacts opens 0 – 5 minutes before transfer in either direction, re-closes after transfer. Can be configured for pre-transfer, post transfer or both.
4. Sequential Universal Motor Load Disconnect (A62) – Multiple auxiliary contacts open before transfer in either direction, re-closes after transfer. Can be configured for pre-transfer, post transfer or both.
5. Communications interface card (ZNET100) – RS-485 Modbus.
6. Test Switch (6A) – Maintained.
7. Digital Meter (M80) - w/Display of Amps, Volts, Frequency.
8. Digital Meter (M82) - w/Display of Amps, Watts, Volts, Frequency, KVA, KVAR, PF, etc. w/Modbus RS485 port.
9. Digital Meter (M83) - w/Display of Amps, Watts, Volts, Frequency, KVA, KVAR, PF, etc. Plus THD capability w/Modbus RS485 port.
10. Additional Auxiliary Contacts (A3) - Closed when the transfer switch is in Source 2 position.
11. Additional Auxiliary Contacts (A4) - Closed when the transfer switch is in Source 1 position.
12. Alarm panel (CTAP) – Alarm on transfer to emergency w/silence button & light
13. Disconnect Switch (DS) - Inhibits transfer in either direction when in inhibit. (Std on 800A and above)
14. Extended warranty (ATGEW) - annual parts and labor warranty (1-4 years for a total of 5 years max.)
15. Protective Cover (OCCUR) - Lockable see-through microprocessor and meters cover for NEMA3R or 12.

The transfer switch manufacturer must perform a complete functional test on the switch, controller and accessories before shipping from the factory. A certified test report must be available on request.

86-2.17C(4) Warranty

Install the OVDS per manufacturer's instructions. OVDS Equipment must be guaranteed, to the original purchaser, to be free from defects in material and/or workmanship for one year from the date of shipment when the equipment is used in accordance with the operation instructions.

86-2.17C(5) Testing

After the completion of all work under "OVERHEIGHT VEHICLE DETECTION AND WARNING SYSTEM," you must test each system in the presence of the Engineer. The testing must be performed before decreasing the vertical clearance. The manufacturer's representative must be on-site during the system testing as required.

86-2.17D Payment

The lump sum price paid for Traffic Control System includes payment for the Overheight Vehicle Detection and Warning System.

DIST	COUNTY	ROUTE	POST MILES TOTAL PROJECT	SHEET No	TOTAL SHEETS
03	ED	50	1.07/R2.40	340	371

P.K. Chen 1/4/13
REGISTERED STRUCTURAL ENGINEER DATE

January 28, 2013
PLANS APPROVAL DATE

The State of California or its officers or agents shall not be responsible for the accuracy or completeness of electronic copies of this plan sheet.

COUNTY OF EL DORADO
DEPT. OF TRANSPORTATION
2850 FAIRLANE COURT
PLACERVILLE, CA 95667

MARK THOMAS & COMPANY, INC.
7300 FOLSOM BOULEVARD, SUITE 203
SACRAMENTO, CA 95826

QUANTITIES

STRUCTURE EXCAVATION (BRIDGE)	486 CY
STRUCTURE BACKFILL (BRIDGE)	266 CY
PRESTRESSING CAST-IN-PLACE CONCRETE	1 LS
STRUCTURAL CONCRETE, BRIDGE FOOTING	58 CY
STRUCTURAL CONCRETE, BRIDGE	486 CY
STRUCTURAL CONCRETE, APPROACH SLAB (TYPE N)	87 CY
DRY STACK ROCK TEXTURE	725 SF
JOINT SEAL (MR 2")	87 LF
BAR REINFORCING STEEL (BRIDGE)	142,088 LB
CONCRETE BARRIER (TYPE 736 MODIFIED)	162 LF
CONCRETE BARRIER (TYPE 742 MODIFIED)	163 LF

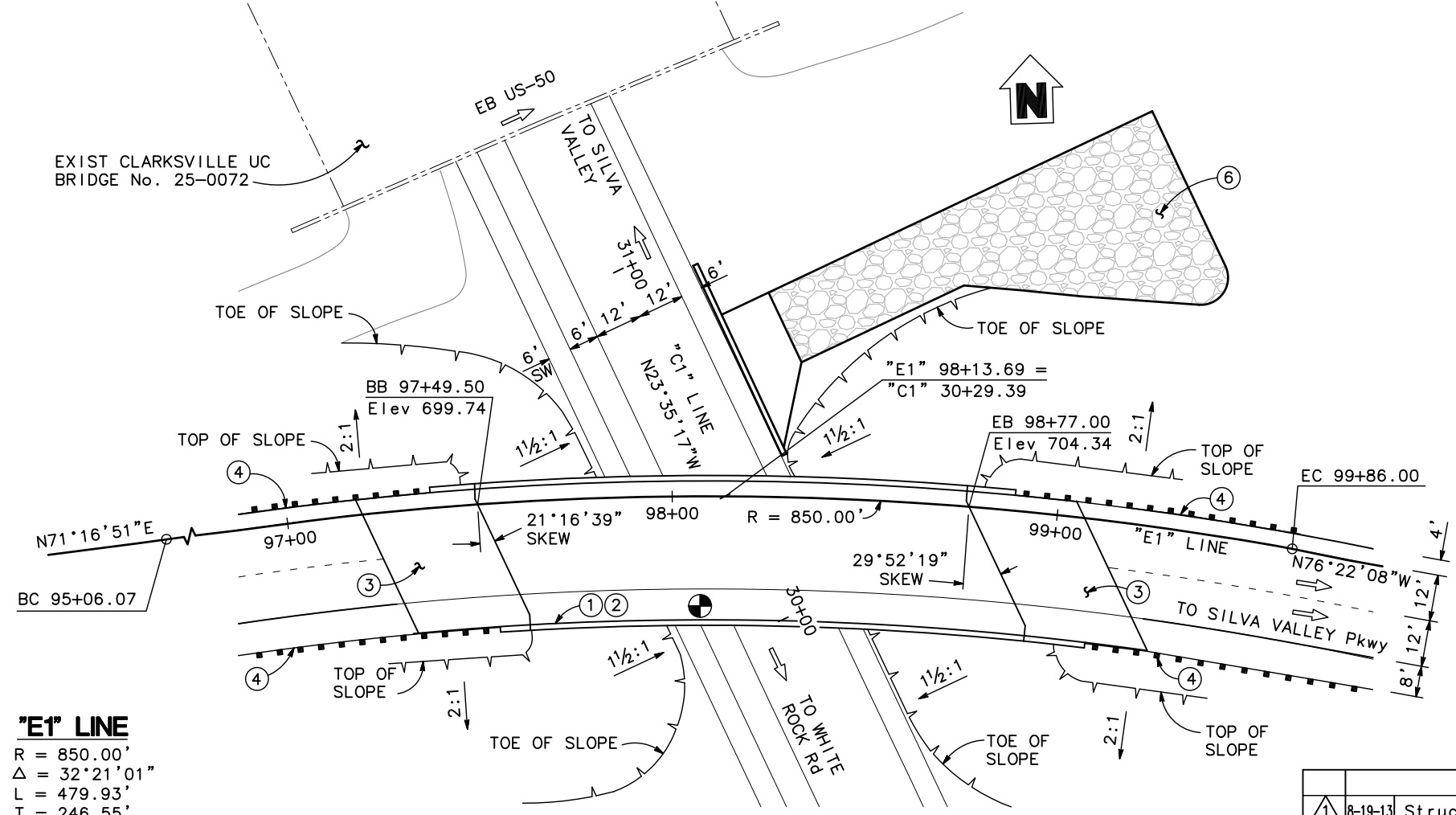
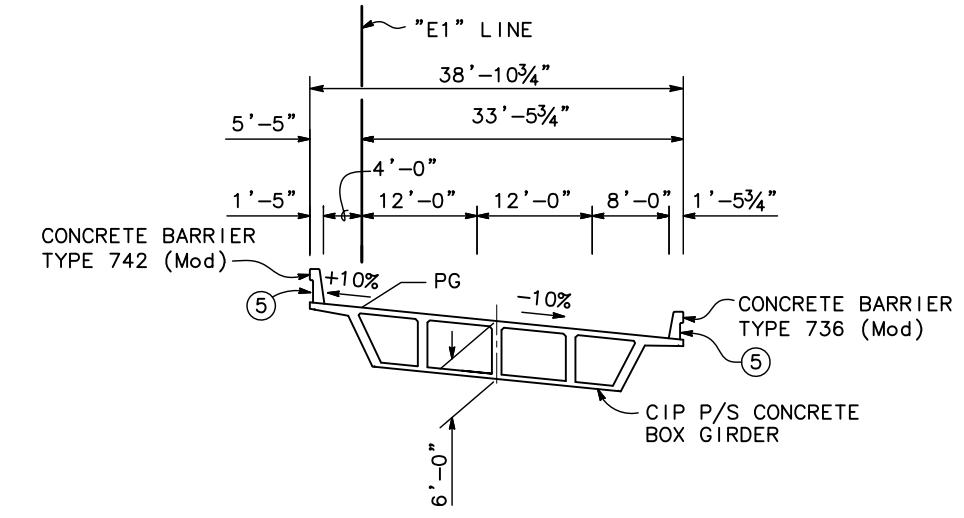
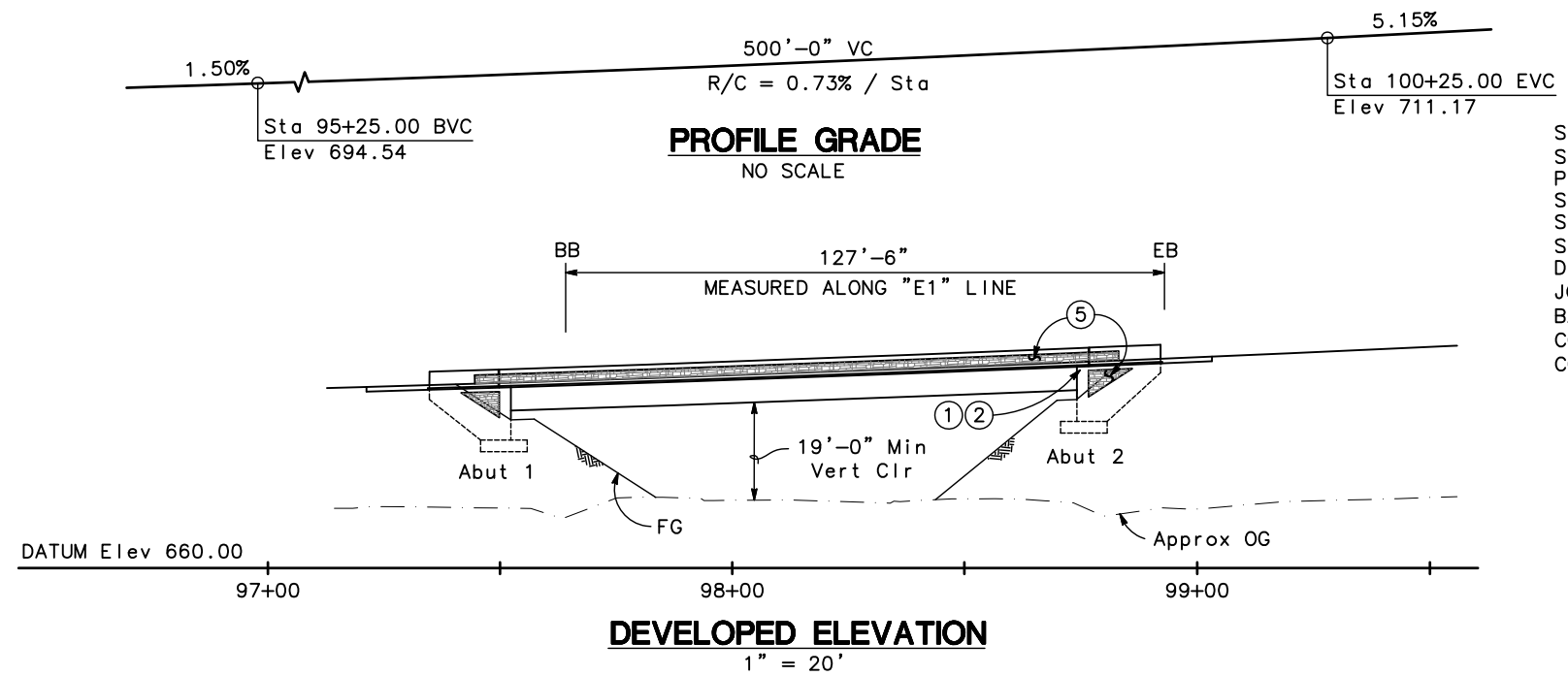

"E1" LINE
R = 850.00'
Δ = 32°21'01"
L = 479.93'
T = 246.55'

TYPICAL SECTION
1" = 10"

NOTES:

- ① Paint "SILVA VALLEY EB OFF-RAMP UC"
 - ② Paint "BR NO. 25-0128S"
 - ③ Structure Approach Slab Type N(30S)
 - ④ MBGR, see "ROAD PLANS"
 - ⑤ Dry Stack Rock Texture
 - ⑥ PG&E Access Road, See "ROAD PLANS"
1. For "GENERAL NOTES" and "INDEX TO PLANS", see "DECK COUNTOURS" sheet.
2. For "SPREAD FOOTING DATA TABLE", see "FOUNDATION PLAN" sheet.

LEGEND:

- ⊙ Indicates Point of Minimum Vertical Clearance
- Indicates Existing Structure

MARK	DATE	DESCRIPTIONS	DES	CHK
1	8-19-13	Structural Concrete, Bridge Modified	TP	JH

DESIGN OVERSIGHT	DESIGN BY S. MICHALSKI	CHECKED P. CHEN	LOAD & RESISTANCE FACTOR DESIGN	LIVE LOADING: HL93 W/"LOW-BOY" PERMIT DESIGN VEHICLE	PREPARED FOR THE STATE OF CALIFORNIA DEPARTMENT OF TRANSPORTATION	BRIDGE NO. 25-0128S	SILVA VALLEY EB OFF-RAMP UC GENERAL PLAN
SIGN OFF DATE	DETAILS BY N. PHAM	CHECKED P. CHEN	LAYOUT BY D. MINNEMA	CHECKED S. MICHALSKI	JULIE PASSALACQUA PROJECT ENGINEER	POST MILES R1.65	
DESIGN GENERAL PLAN SHEET (ENGLISH) (REV.7/16/10)	QUANTITIES BY V. SHERBY	CHECKED T. PHAM	SPECIFICATIONS BY J. PASSALACQUA	PLANS AND SPECS COMPARED P. CHEN	UNIT: 03-1E2901 PROJECT NUMBER & PHASE: 0300000258	DISREGARD PRINTS BEARING EARLIER REVISION DATES	

REVISION DATES (PRELIMINARY STAGE ONLY)

11/08/10	3/28/12	5/21/12	9/28/12	10/28/12	1/15/13
----------	---------	---------	---------	----------	---------

SHEET 1 OF 21

CONTRACT NO. 13-0677 3A 65 of 65