

Project Summary

Applicant: Mount Aukum Winery LLC DBA Kehret Vineyards
Contact Person: Valerie Barry
Address: physical – 6781 Tower Road Somerset, CA 95684
Mailing – PO Box 830 Mount Aukum, CA 95656

Telephone: 209.245.3757 or m 702.683.1424
Email: val@kehretvineyards.com

Number of Chargers to be installed: 2

Number of Chargers that will be ADA van accessible: 2

Number of customer trips to the site on an annual basis: 6000

Number of customers utilizing EVSE on an annual basis: 500

EVSE availability to public: Friday – Sunday 11:00am to 5:00pm

Match Commitment and Acknowledgement

By signing below the applicant acknowledges that if the proposal is awarded, the contract will require the compliance with the match and acknowledgments.



Valerie Barry March 1, 2019

Connect with
Carnahan Electric, Ltd.



Commercial, Industrial, Residential
Installations, Repairs, and Consulting

February 15, 2019

Mount Aukum Winery (Bill Kerhert owner)

6781 Tower Road, Somerset, Ca 95684

Valarie Barry (business manager) Tel: 209-245-3757 cell: 702-683-1424

Email: valkbarry@aol.com admin@mountaukum.com

Proposal to install 2 Clipper Creek car chargers, double headers and one 80amp Clipper Creek high speed car charger to be used in conjunction with adapter provided by Tesla for car charging.

Carnahan Electric Ltd. will provide the following equipment, material and labor to fully install charging stations in location pre-determined by customer. All trenching to be done by others: (No permit)

1. One Clipper Creek CS 80 high speed 80 amp charger to be adaptable to Tesla car charging by equipment provided to Tesla car owners by Tesla. This charger is the fastest Clipper Creek has available and is not being represented to perform at the 480v Tesla charging level. The Tesla 480v, 3phase installation is not available at this location.
2. One Clipper Creek pedestal for CS 80 high speed charger.
3. One Clipper Creek CS40/w pedestal, dual head.
4. All other ancillary material, parts and electrical equipment necessary for complete installation, except trenching.

Total price, including material, tax and labor: \$14,227.13

To accept this proposal, please sign and include a 60% deposit.

Signature: _____ Date: _____



6781 Tower Rd, Somerset, Ca 95684



Sign in

Back to web results for **6781 Tower Rd, Somerset, Ca 95684**

6781 Tower Rd

No reviews

6781 Tower Rd

DIRECTIONS

Looking for something different?

See web results

Diamond Springs, California - From your Internet address

Use precise location - Learn more

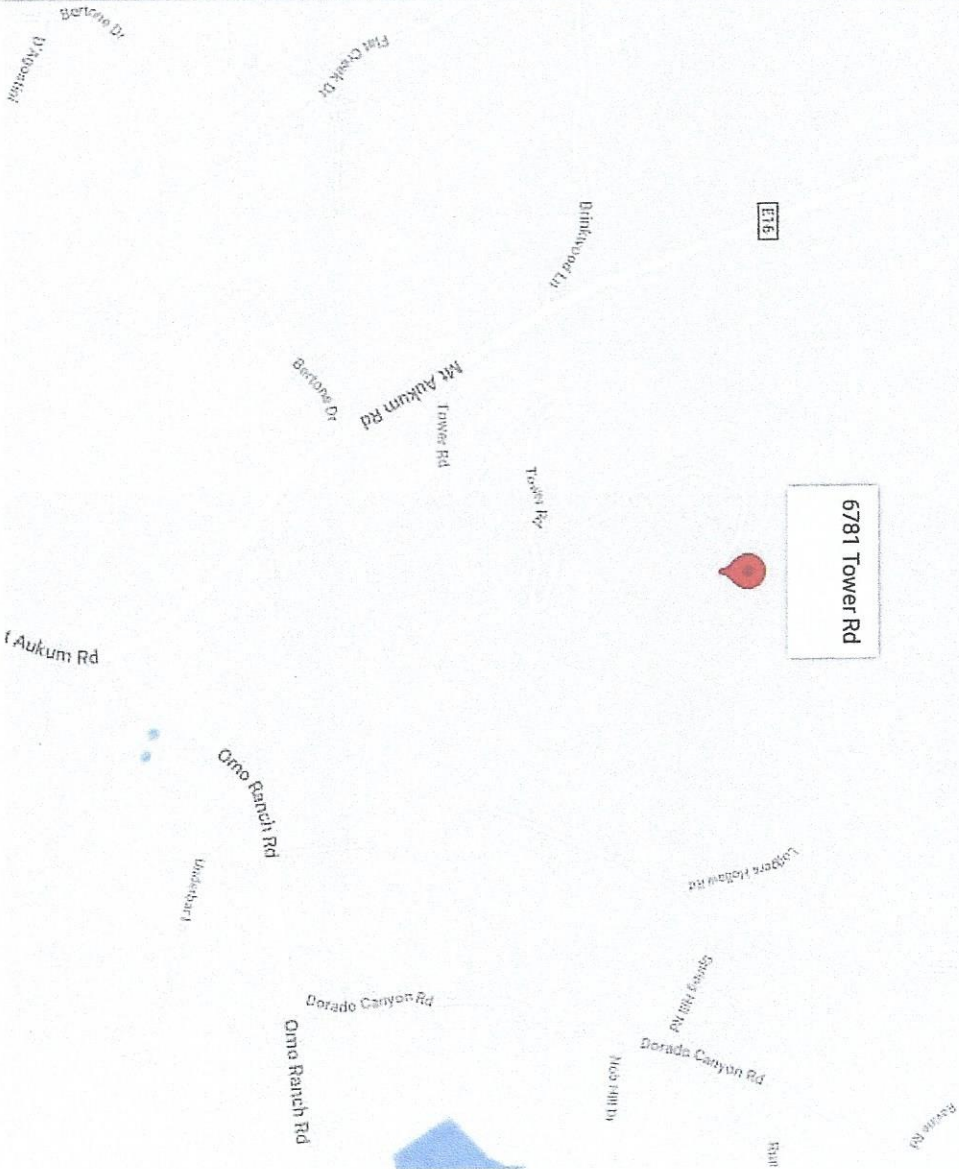

Help Send feedback Privacy Terms



Mt. Aukum Winery 6781 Tower Rd. Somerset, Ca 95684

Write a description for your map.

Legend

-  6781 Tower Rd
-  Mount Aukum



Google Earth

@ 2018 Google

90 ft



HCS PEDESTAL MOUNT



RUGGED, CONVENIENT INSTALLATION. ClipperCreek's single or dual mounted charging system suits all commercial HCS installation needs at an affordable price.

- **LOW COST** – Minimize your installation costs and mount one or two units on a single pedestal
- **UNIVERSAL** – Industry standard bolt platform pattern to replace outdated charging stations
- **TOUGH** – Powder coated steel pedestal with NEMA 4, fully sealed charging station
- **RELIABLE** – Backed by ClipperCreek's 3-year warranty
- **CONVENIENT** – All units come equipped with 2 knockouts positioned for a 120V outlet



HCS PEDESTAL MOUNT

PRODUCT OVERVIEW

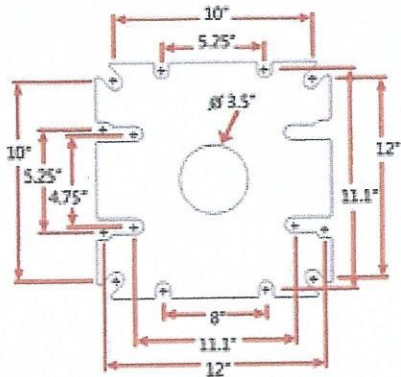

Industry standard bolt pattern and pedestal base dimensions

PARTS INCLUDED

- 25ft of cable
- 3/4" conduit
- Holster
- Pedestal cap
- Base plate vanity cover
- Integrated cable holder
- Station mounting hardware (concrete bolts not included)



An installation cross-section

FEATURES

- Single or dual mount pedestal
- Industry standard bolt pattern to replace outdated charging stations
- 4" steel pedestal post - 1/8" thick
- Steel pedestal base - 1/4" thick
- Powder coated with primer undercoat for environmental durability
- Pedestal doubles as an electrical raceway with a ground lug
- Slim, modern profile

OPTIONS AVAILABLE

120V GFCI protected outlet

QUESTIONS? TO ORDER!

Call ClipperCreek Today!

530-887-1674

www.clippercreek.com

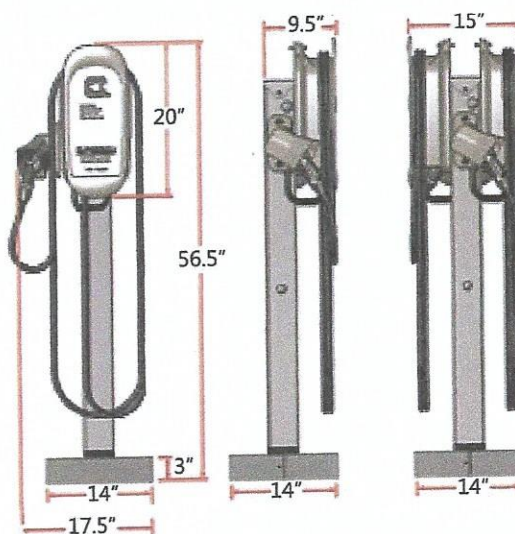

HCS Pedestal Dimensions for single and dual mounted installations





 Delta

C Phase
High leg

lights 

Pump

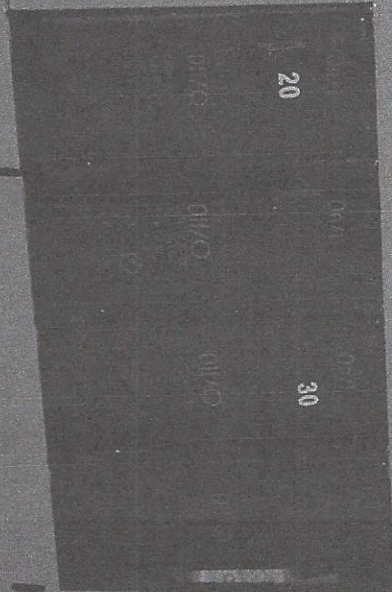

Bottle
Mach.

label
Machine

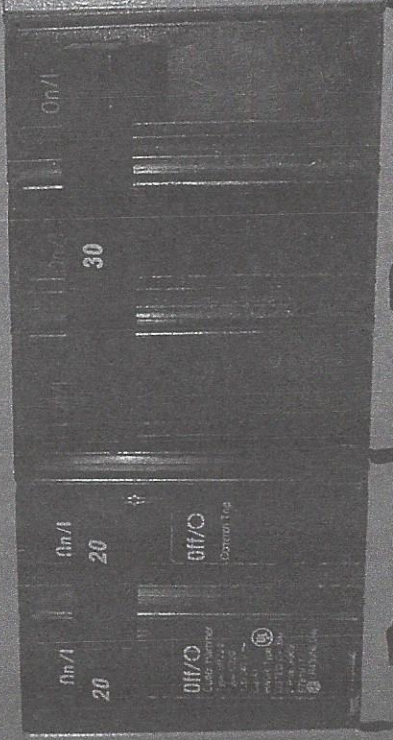

Main Electric Panel

Sub Panel



LIGHT
Sub
Panel
'A'

Transformer

CONTROL/START Kill

CIRCULATING PUMP

Lights

WATER
PUMP
Cool

WATER
PUMP
#1

WATER
PUMP
#2

Heat

WATER
PUMP
#2,3

WATER PUMP COOLET

WATER PUMP COOLET

AC
CONDENSER
UNIT #1

AC
CONDENSER
UNIT #2

Estimate

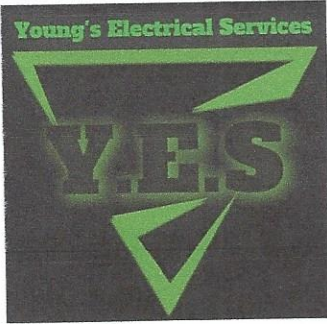

Customer Valerie Barry
6781 Tower Rd
Somerset, CA 95684

From James Young
Young's Electrical Services
3100 Pioneer Hill Rd
Placerville, CA 95667
530-639-8021
yes@youngs-electrical.com
License #: 1018439

Estimate Number 2510
Sent Date February 4, 2019
Expires Never

Estimate for Vehicle Charging Station

Item	Quantity	Price	Total
50 amp dedicated circuit	2	\$1,150.00	\$2,300.00
HCS-50, 40A L2 EVSE 240V, w/25 ft cable <small>Notes: includes pedestal if needed</small>	2 hours	\$2,800.00	\$5,600.00
Trench	1	\$500.00	\$500.00
3/4 pvc	2	\$500.00	\$1,000.00
50 amp commercial breaker installed	2	\$185.00	\$370.00
Subtotal			\$9,770.00
Total			\$9,770.00

Notes

You the buyer, may cancel this transaction at any time prior to midnight of the third business day after the date of this transaction. See the attached notice notice of cancellation form for an explanation of this right.

"THREE-DAY" RIGHT TO CANCEL

"You, the buyer, have the right to cancel this contract within three business days. You may cancel by e-mailing, mailing, faxing, or delivering a written notice to the contractor at the contractor's place of business by midnight of the third business day after you received a signed and dated copy of the contract that includes

Notes (cont.)

this notice. Include your name, your address, and the date you received the signed copy of the contract and this notice. If you cancel, the contractor must return to you anything you paid within 10 days of receiving the notice of cancellation. For your part, you must make available to the contractor at your residence, in substantially as good condition as you received it, any goods delivered to you under this contract or sale. Or, you may, if you wish, comply with the contractor's instructions on how to return the goods at the contractor's expense and risk. If you do make the goods available to the contractor and the contractor does not pick them up within 20 days of the date of your notice of cancellation, you may keep them without any further obligation. If you fail to make the goods available to the contractor, or if you agree to return the goods to the contractor and fail to do so, then you remain liable for performance of all obligations under the contract."

Google Maps 6781 Tower Rd

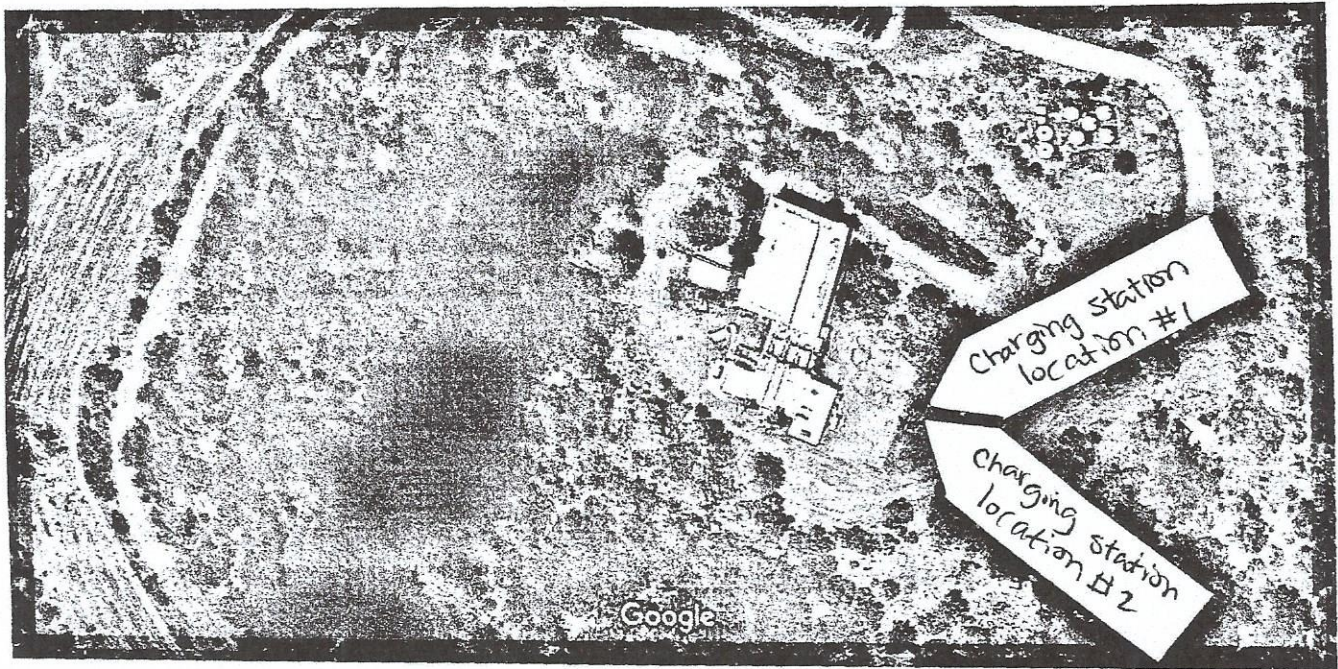

Imagery ©2019 Google, Map data ©2019 Google 50 ft

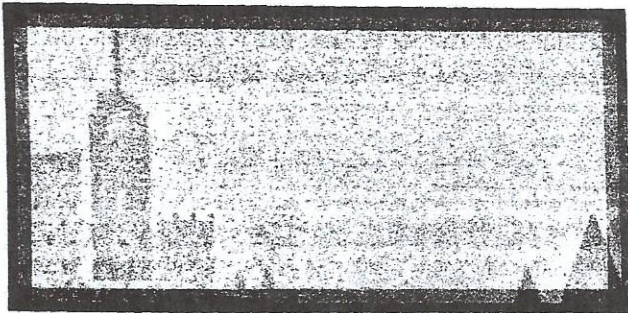

6781 Tower Rd
Mt Aukum, CA 95656